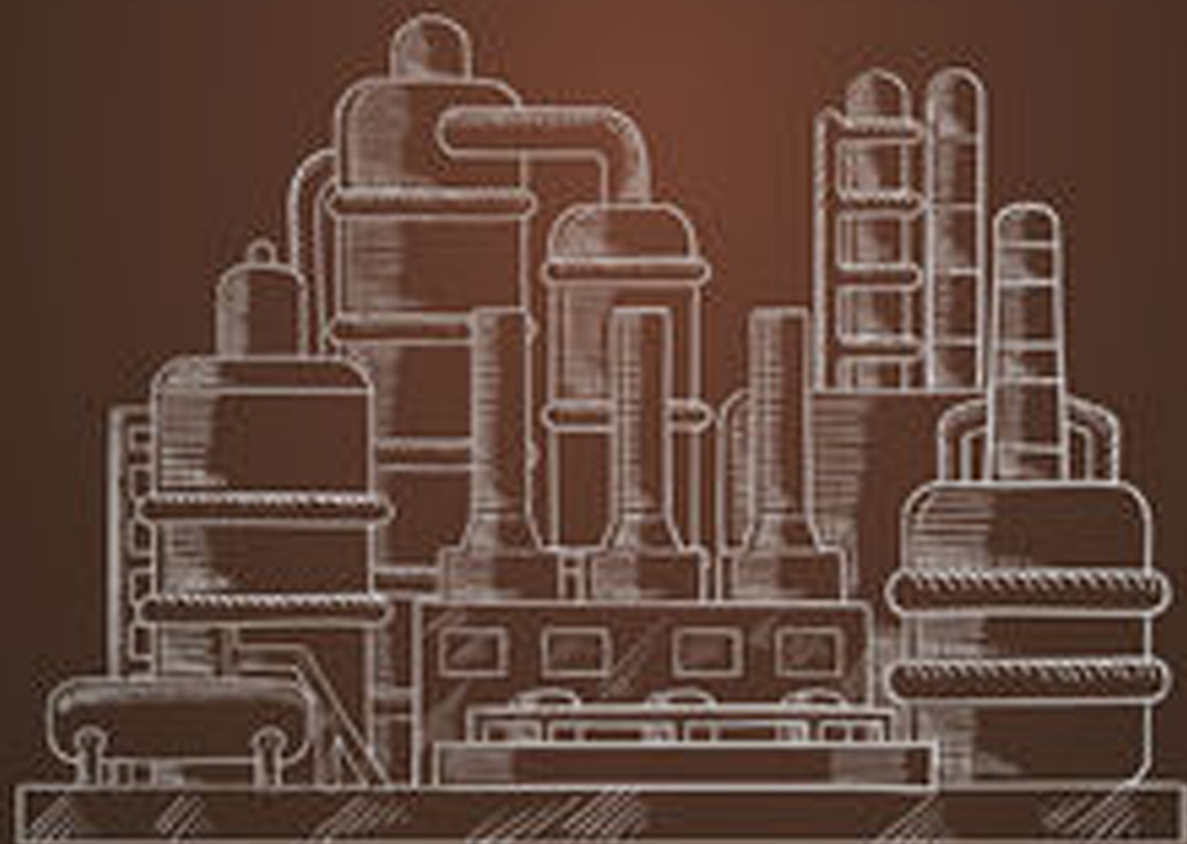


VOLUME 1

PETROLEUM
REFINING

DESIGN AND APPLICATIONS HANDBOOK

A. KAYODE COKER



 Scrivener
Publishing

WILEY

Petroleum Refining Design and Applications Handbook

Scrivener Publishing

100 Cummings Center, Suite 541J
Beverly, MA 01915-6106

Publishers at Scrivener

Martin Scrivener (martin@scrivenerpublishing.com)
Phillip Carmical (pcarmical@scrivenerpublishing.com)

Petroleum Refining Design and Applications Handbook

Volume 1

A. Kayode Coker



WILEY

This edition first published 2018 by John Wiley & Sons, Inc., 111 River Street, Hoboken, NJ 07030, USA and Scrivener Publishing LLC, 100 Cummings Center, Suite 541J, Beverly, MA 01915, USA
© 2018 Scrivener Publishing LLC
For more information about Scrivener publications please visit www.scrivenerpublishing.com.

All rights reserved. No part of this publication may be reproduced, stored in a retrieval system, or transmitted, in any form or by any means, electronic, mechanical, photocopying, recording, or otherwise, except as permitted by law. Advice on how to obtain permission to reuse material from this title is available at <http://www.wiley.com/go/permissions>.

Wiley Global Headquarters

111 River Street, Hoboken, NJ 07030, USA

For details of our global editorial offices, customer services, and more information about Wiley products visit us at www.wiley.com.

Limit of Liability/Disclaimer of Warranty

While the publisher and authors have used their best efforts in preparing this work, they make no representations or warranties with respect to the accuracy or completeness of the contents of this work and specifically disclaim all warranties, including without limitation any implied warranties of merchantability or fitness for a particular purpose. No warranty may be created or extended by sales representatives, written sales materials, or promotional statements for this work. The fact that an organization, website, or product is referred to in this work as a citation and/or potential source of further information does not mean that the publisher and authors endorse the information or services the organization, website, or product may provide or recommendations it may make. This work is sold with the understanding that the publisher is not engaged in rendering professional services. The advice and strategies contained herein may not be suitable for your situation. You should consult with a specialist where appropriate. Neither the publisher nor authors shall be liable for any loss of profit or any other commercial damages, including but not limited to special, incidental, consequential, or other damages. Further, readers should be aware that websites listed in this work may have changed or disappeared between when this work was written and when it is read.

Library of Congress Cataloging-in-Publication Data

ISBN 978-1-118-23369-6

Cover design by Kris Hackerott

Cover Image: Refinery Illustration, Seamartini | Dreamstime.com

Set in size of 11pt and Minion Pro by Exeter Premedia Services Private Ltd., Chennai, India

Printed in the USA

10 9 8 7 6 5 4 3 2 1

To my wife, Victoria O. Coker for her forbearance and fortitude.
Love and Thanks

To the spiritual guides and invisible helpers in Creation without which this project
cannot be accomplished.
Sincere and deepest gratitude

To all personnel working in petroleum refineries and petrochemical industries world
wide and endeavoring to make their facilities safe.

“God wills that His Laws working in Creation should be quite familiar to man, so that
he can adjust himself accordingly, and with their help can complete and fulfil his course
through the world more easily and without ignorantly going astray.”

Abd-ru-shin
(In the Light of Truth)

The Laws of Creation

The Law of the Attraction of Homogeneous Species

The Law of Gravitation

The Law of Reciprocal Action

“What is Truth?”

Pilate (John 18, 38)

“Only the truth is simple.”

Sebastian Haffner

“Woe to the people to whom the truth is no longer sacred!”

Friedrich Christoph Schlosser

“Truth does not conform to us, dear son but we have to conform with it.”

Matthias Claudius

“Nothing will give safety except truth. Nothing will give peace except the serious search for truth.”

Blaise Pascal

“Truth is the summit of being: justice is the application of it to affairs”

Ralph Waldo Emerson

“The ideals which have lighted my way, and time after time have given me new courage to face
cheerfully, have been Kindness, Beauty and Truth”

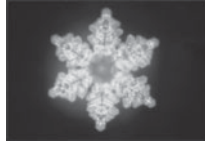
Albert Einstein

“It irritates people that the truth is so simple”.

Johann Wolfgang von Goethe

“Truth is the Eternal - Unchangeable! Which never changes in its form, but is as it has been
eternally and will ever remain, as it is now. Which can therefore never be subjected to any
development either, because it has been perfect from the very beginning. Truth is real, it is ‘being’!
Only being is true life. The entire Universe is “supported” by this Truth!”

Abd-ru-shin



Truth

To honor God in all things and to perform everything solely to the glory of God

**Abd-ru-shin
(In The Light of Truth)**

Awake!

Keep the heart of your thoughts pure, by so doing you will bring peace and be happy.

Love thy neighbour, which means honour him as such!

**There in lies the adamantine command: You must never consciously harm him, either in his body
or in his soul, either in his earthly possessions or in his reputation!**

**He who does not keep this commandment and acts otherwise, serves not God but the darkness, to
which he gives himself as a tool!**

Honour be to God Who only sows Love! Love also in The Law of the destruction of the darkness!

**Abd-ru-shin
(In the Light of Truth)**



Love & Gratitude

Crystal Images © Office Masaru Emoto, LLC

Contents

Preface	xix
Acknowledgments	xxi
About the Author	xxiii
1 Introduction	1
References	6
2 Composition of Crude Oils and Petroleum Products	7
2.1 Hydrocarbons	8
2.1.1 Alkynes Series	12
2.2 Aromatic Hydrocarbons	14
2.3 Heteroatomic Organic Compounds	15
2.3.1 Non-Hydrocarbons	15
2.3.2 Sulfur Compounds	18
2.4 Thiols	18
2.5 Oxygen Compounds	20
2.6 Nitrogen Compounds	22
2.7 Resins and Asphaltenes	23
2.8 Salts	24
2.9 Carbon Dioxide	24
2.10 Metallic Compounds	24
2.11 Products Composition	25
2.11.1 Liquefied Petroleum Gas (LPG) (C_3 and C_4)	26
2.11.2 Gasoline (C_5 to C_{11})	26
2.11.3 Condensate (C_4 , C_5 and C_6 >)	27
2.11.4 Gas Fuel Oils (C_{12} to C_{19})	27
2.11.5 Kerosene	27
2.11.6 Diesel Fuel	28
2.11.7 Fuel Oils # 4, 5, and 6	28
2.11.8 Residual Fuel Oil	28
2.11.9 Natural Gas	29
References	30
3 Characterization of Petroleum and Petroleum Fractions	31
3.1 Introduction	31
3.1.1 Crude Oil Properties	32
3.1.2 Gravity, API	32
3.1.3 Boiling Point Range	33
3.1.4 Characterization Factor	33
3.1.5 The Universal Oil Product Characterization factor, K_{UOP}	34
3.1.6 Carbon Residue, wt%	34
3.1.7 Nitrogen Content, wt%	36
3.1.8 Sulfur Content, wt%	36

3.1.9	Total Acid Number (TAN)	36
3.1.10	Salt Content, pounds/1000 barrels	36
3.1.11	Metals, parts/million (ppm) by weight	36
3.1.12	Pour Point (°F or °C)	36
3.2	Crude Oil Assay Data	37
3.2.1	Whole crude oil average properties	37
3.2.2	Fractional properties	37
3.3	Crude Cutting Analysis	37
3.4	Crude Oil Blending	37
3.5	Laboratory Testing of Crude Oils	46
3.5.1	True Boiling Point (TBP) Curve	46
3.5.2	ASTM D86 Distillation	46
3.5.3	Boiling Points	47
3.5.4	Conversion Between ASTM and TBP Distillation	49
3.5.5	Petroleum Pseudo-Components	54
3.5.6	Pseudo-Component Normal Boiling Points	55
3.5.7	ASTM D1160 Distillation	55
3.5.8	Determination of ASTM IBP, 10%, 20–90% Points of Blend	55
3.5.9	ASTM 10–90% Points	56
3.5.10	Initial Boiling Point Determination	56
3.5.11	ASTM End Point of Blend	56
3.5.12	Flash Point	56
3.5.13	Flash Point, °F, as a Function of Average Boiling Point	57
3.5.14	Smoke Point of Kerosenes	57
3.5.15	Luminometer Number	57
3.5.16	Reid Vapor Pressure (RVP)	57
3.5.17	Vapor Pressure of Narrow Hydrocarbon Cuts	58
3.6	Octanes	58
3.7	Cetanes	58
3.7.1	Cetane Index	59
3.8	Diesel Index	59
3.9	Determination of the Lower Heating Value of Petroleum Fractions	59
3.10	Aniline Point Blending	60
3.11	Correlation Index (CI)	60
3.12	Chromatographically Simulated Distillations	61
	References	62
4	Thermodynamic Properties of Petroleum and Petroleum Fractions	63
4.1	K-Factor Hydrocarbon Equilibrium Charts	64
4.2	Non-Ideal Systems	72
4.3	Vapor Pressure	74
4.3.1	Vapor Pressure Determination using the Clausius-Clapeyron and the Antoine Equations	75
4.4	Viscosity	80
4.4.1	Conversion to Saybolt Universal Viscosity	80
4.4.2	Conversion to Saybolt Furol Viscosity	82
4.4.3	Equivalents of Kinematic (cSt), Saybolt Universal (SUS), and Dynamic viscosity	82
4.4.4	Viscosity of Liquid Hydrocarbons	83
4.4.5	Gas Viscosity	84
4.5	Refractive Index	87
4.6	Liquid Density	89
4.6.1	Gas Density	89

4.7	Molecular Weight	90
4.8	Molecular Type Composition	90
4.9	Critical Temperature, T_c	96
4.10	Critical Pressure, P_c	97
4.11	Pseudo-Critical Constants and Acentric Factors	98
4.12	Enthalpy of Petroleum Fractions	99
4.13	Compressibility Z Factor of Natural Gases	100
4.14	Simulation Thermodynamic Software Programs	105
	References	110
5	Process Descriptions of Refinery Processes	111
5.1	Introduction	111
5.2	Refinery and Distillation Processes	115
5.3	Process Description of the Crude Distillation Unit	120
5.3.1	Crude Oil Desalting	121
5.3.2	Types of Salts in Crude Oil	122
5.3.3	Desalting Process	122
5.3.4	Pumparound Heat Removal	127
5.3.5	Tower Pressure Drop and Flooding	130
5.3.6	Carbon Steel Trays	130
5.3.7	Rectifying Section of the Main Column	130
5.3.8	Side Stripping Columns	130
5.3.9	Crude Column Overhead	130
5.3.10	General Properties of Petroleum Fractions	130
5.4	Process Variables in the Design of Crude Distillation Column	132
5.4.1	Process Design of a Crude Distillation Column	133
5.5	Process Simulation	134
5.5.1	Overall Check of Simulation	135
5.5.2	Other Aspects of Design	136
5.5.3	Relationship between Actual Trays and Theoretical Trays	137
5.6	Process Description of Light Arabian Crude Using UniSim [®] Simulation Software [12]	138
5.6.1	Column Conventions	141
5.6.2	Performance Specifications Definition	142
5.6.3	Cut Points	142
5.6.4	Degree of Separation	142
5.6.5	Overflash	142
5.6.6	Column Pressure	143
5.6.7	Overhead Temperature	143
5.6.8	Bottom Stripping	144
5.6.9	Side Stream Stripper	144
5.6.10	Reflux	144
5.7	Troubleshooting Actual Columns	144
5.8	Health, Safety and Environment Considerations	145
	References	148
6	Thermal Cracking Processes	149
6.1	Process Description	152
6.2	Steam Jet Ejector	152
6.3	Pressure Survey in a Vacuum Column	154
6.4	Simulation of Vacuum Distillation Unit	156

6.5	Coking	157
6.5.1	Delayed Coking	157
6.5.2	Delayed Coker Yield Prediction	161
6.5.3	Coke Formation	162
6.5.4	Thermodynamics of Coking of Light Hydrocarbons	162
6.5.5	Gas Composition	163
6.6	Fluid Coking	164
6.6.1	Flexi-Coking	165
6.6.2	Contact Coking	167
6.6.3	Coke Drums	168
6.6.4	Heavy Coker Gas Oil (HCGO) Production	170
6.6.5	Light Coker Gas Oil (LCGO) Production	170
6.7	Fractionator Overhead System	170
6.8	Coke Drum Operations	172
6.9	Hydraulic Jet Decoking	173
6.10	Uses of Petroleum Coke	174
6.11	Use of Gasification	174
6.12	Sponge Coke	175
6.13	Safety and Environmental Considerations	175
6.14	Simulation/Calculations	176
6.15	Visbreaking	177
6.15.1	Visbreaking Reactions	180
6.15.2	Visbreaking Severity	180
6.15.3	Operation and Control	180
6.15.4	Typical Visbreaker Unit	181
6.15.5	Typical Visbreaker Unit with Vacuum Flasher	182
6.15.6	Typical Combination Visbreaker and Thermal Cracker	183
6.15.7	Product Yield	183
6.16	Process Simulation	184
6.17	Health, Safety and Environment Considerations	185
	References	186
7	Hydroprocessing	187
7.1	Catalytic Conversion Processes	187
7.1.1	Hydrocracking Chemistry	188
7.1.2	Hydrocracking Reactions	190
7.1.3	Typical Hydrocracking Reactions	191
7.2	Feed Specifications	194
7.2.1	Space Velocity	195
7.2.2	Reactor Temperature	195
7.2.3	Reactor Pressure	195
7.2.4	Hydrogen Recycle Rate	195
7.2.5	Oil Recycle Ratio	195
7.2.6	Heavy Polynuclear Aromatics	196
7.3	Feed Boiling Range	196
7.4	Catalyst	196
7.4.1	Catalyst Performance	197
7.4.2	Loss of Catalyst Performance	197
7.4.3	Poisoning by Impurities in Feeds or Catalysts	198
7.4.4	The Apparent Catalyst Activity	200

7.5	Poor Gas Distribution	200
7.6	Poor Mixing of Reactants	200
7.7	The Mechanism of Hydrocracking	200
7.8	Thermodynamics and Kinetics of Hydrocracking	201
7.9	Process Design, Rating and Performance	204
	7.9.1 Operating Temperature and Pressure	205
	7.9.2 Optimum Catalyst Size and Shape	205
	7.9.3 Pressure Drop (ΔP) in Tubular/Fixed-Bed Reactors	205
	7.9.4 Catalyst Particle Size	207
	7.9.5 Vessel Dimensions	208
7.10	Increased ΔP	210
7.11	Factors Affecting Reaction Rate	214
7.12	Measurement of Performance	215
7.13	Catalyst-Bed Temperature Profiles	216
7.14	Factors Affecting Hydrocracking Process Operation	217
7.15	Hydrocracking Correlations	217
	7.15.1 Maximum Aviation Turbine Kerosene (ATK) Correlations	219
	7.15.2 Process Description	220
	7.15.3 Fresh Feed and Recycle Liquid System	224
	7.15.4 Liquid and Vapor Separators	225
	7.15.5 Recycle Gas Compression and Distribution	226
	7.15.6 Hydrogen Distribution	226
	7.15.7 Control of the Hydrogen System	226
	7.15.8 Reactor Design	227
7.16	Hydrocracker Fractionating Unit	228
	7.16.1 Mild Vacuum Column	230
	7.16.2 Steam Generation	230
7.17	Operating Variables	231
7.18	Hydrotreating Process	234
	7.18.1 Process Description	237
	7.18.2 Process Variables	237
	7.18.3 Hydrotreating Catalysts	240
7.19	Thermodynamics of Hydrotreating	240
7.20	Reaction Kinetics	243
7.21	Naphtha Hydrotreating	245
	7.21.1 Hydrotreating Correlations	245
	7.21.2 Middle Distillates Hydrotreating	248
	7.21.3 Middle Distillate Hydrotreating Correlations	248
7.22	Atmospheric Residue Desulfurization	250
	7.22.1 High-Pressure Separator	252
	7.22.2 Low-Pressure Separator	252
	7.22.3 Hydrogen Sulfide Removal	252
	7.22.4 Recycled Gas Compressor	252
	7.22.5 Process Water	252
	7.22.6 Fractionation Column	253
	7.22.7 Operating Conditions of Hydrotreating Processes	253
7.23	Health, Safety and Environment Considerations	258
	References	258

8	Catalytic Cracking	259
8.1	Introduction	259
8.2	Fluidized Bed Catalytic Cracking	262
8.2.1	Process Description	262
8.3	Modes of Fluidization	269
8.4	Cracking Reactions	270
8.4.1	Secondary Reactions	272
8.5	Thermodynamics of FCC	273
8.5.1	Transport Phenomena, Reaction Patterns and Kinetic models	273
8.5.2	Three- and Four-Lump kinetic models	276
8.6	Process Design Variables	278
8.6.1	Process Variables	279
8.6.2	Process Operational Variables	280
8.7	Material and Energy Balances	281
8.7.1	Material Balance	281
8.7.2	Energy Balance	282
8.8	Heat Recovery	283
8.9	FCC Yield Correlations	284
8.10	Estimating Potential Yields of FCC Feed	286
8.11	Pollution Control	290
8.12	New Technology	292
8.12.1	Deep Catalytic Cracking	293
8.12.2	Shell's Fluid Catalytic Cracking	294
8.12.3	Fluid Catalytic Cracking High Severity	295
8.12.4	Fluid Catalytic Cracking for Maximum Olefins	295
8.13	Refining/Petrochemical Integration	296
8.14	Metallurgy	296
8.15	Troubleshooting for Fluidized Catalyst Cracking Units	297
8.16	Health, Safety and Environment Considerations	298
8.17	Licensors' Correlations	299
8.18	Simulation and Modeling Strategy	300
	References	304
9	Catalytic Reforming and Isomerization	305
9.1	Introduction	305
9.2	Catalytic Reforming	306
9.3	Feed Characterization	306
9.4	Catalytic Reforming Processes	308
9.4.1	Role of Reformer in the Refinery	309
9.4.2	UOP Continuous Catalytic Regeneration (CCR) Reforming Process	310
9.5	Operations of the Reformer Process	312
9.5.1	Effect of Major Variables in Catalytic Reforming	314
9.6	Catalytic Reformer Reactors	316
9.7	Material Balance in Reforming	317
9.8	Reactions	320
9.8.1	Naphthene Dehydrogenation to Cyclohexanes	320
9.8.2	Dehydrocyclization of Paraffins to Aromatics	321
9.8.3	Dehydroisomerization of Alkylcyclopentanes to Aromatics	321
9.8.4	Isomerization of n-Paraffins	321
9.9	Hydrocracking Reactions	322

9.10	Reforming Catalyst	322
9.11	Coke Deposition	324
9.12	Thermodynamics	326
9.13	Kinetic Models	326
9.14	The Reactor Model	326
9.15	Modeling of Naphtha Catalytic Reforming Process	329
9.16	Isomerization	329
	9.16.1 Thermodynamics	330
	9.16.2 Isomerization Reactions	331
9.17	Sulfolane Extraction Process	331
	9.17.1 Sulfolane Extraction Unit (SEU) Corrosion Problems	332
	9.17.2 Other Solvents for the Extraction Unit	333
9.18	Aromatic Complex	333
	9.18.1 Aromatic Separation	335
9.19	Hydrodealkylation Process	336
	9.19.1 Separation of the Reactor Effluents	337
	References	337
10	Alkylation and Polymerization Processes	339
10.1	Introduction	339
10.2	Chemistry of Alkylation	340
10.3	Catalysts	342
10.4	Process Variables	343
10.5	Alkylation Feedstocks	345
10.6	Alkylation Products	346
10.7	Sulfuric Acid Alkylation Process	346
10.8	HF Alkylation	347
10.9	Kinetics and Thermodynamics of Alkylation	351
10.10	Polymerization	354
10.11	HF and H ₂ SO ₄ Mitigating Releases	354
10.12	Corrosion Problems	356
10.13	A New Technology of Alkylation Process Using Ionic Liquid	356
10.14	Chevron – Honeywell UOP Ionic liquid Alkylation	357
10.15	Chemical Release and Flash Fire: A Case Study of the Alkylation Unit at the Delaware City Refining Company (DCRC) Involving Equipment Maintenance Incident	358
	References	362
11	Hydrogen Production and Purification	365
11.1	Hydrogen Requirements in a Refinery	365
11.2	Process Chemistry	366
11.3	High-Temperature Shift Conversion	368
11.4	Low-Temperature Shift Conversion	368
11.5	Gas Purification	368
11.6	Purification of Hydrogen Product	369
11.7	Hydrogen Distribution System	370
11.8	Off-Gas Hydrogen Recovery	371
11.9	Pressure Swing Adsorption (PSA) Unit	371
11.10	Refinery Hydrogen Management	375
11.11	Hydrogen Pinch Studies	377
	References	379

12 Gas Processing and Acid Gas Removal	381
12.1 Introduction	381
12.2 Diesel Hydrodesulfurization (DHDS)	383
12.3 Hydrotreating Reactions	383
12.4 Gas Processing	388
12.4.1 Natural Gas	388
12.4.2 Gas Processing Methods	389
12.4.3 Reaction Gas Processes	390
12.4.4 Sweetening Process	390
12.4.5 MEROX Process	390
12.5 Sulfur Management	391
12.5.1 Sulfur Recovery Processes	393
12.5.2 Tail Gas Clean Up	401
12.6 Physical Solvent Gas Processes	401
12.6.1 Physical and Chemical Processes	402
12.6.2 Advantages and Disadvantages of the Sulfinol® Process	402
12.7 Carbonate Process	402
12.8 Solution Batch Process	403
12.9 Process Description of Gas Processing using UniSim® Simulation	405
12.10 Gas Dryer (Dehydration) Design	410
12.10.1 The Equations	412
12.10.2 Pressure Drop (ΔP)	413
12.10.3 Fouled Bed	413
12.11 Kremser-Brown-Sherwood Method-No Heat of Absorption	415
12.11.1 Absorption: Determine Component Absorption in Fixed Tray Tower (Adapted in part from Ref. 12)	415
12.11.2 Absorption: Determine the Number of Trays for Specified Product Absorption	417
12.11.3 Stripping: Determine the Number of Theoretical Trays and Stripping Steam or Gas Rate for a Component Recovery	418
12.11.4 Stripping: Determine Stripping-Medium Rate for a Fixed Recovery	420
12.12 Absorption: Edmister Method	421
12.12.1 Absorption and Stripping Efficiency	427
12.13 Gas Treating Troubleshooting	432
12.13.1 High Exit Gas Dew Point	432
12.13.2 High Glycol Losses	432
12.13.3 Glycol Contamination	432
12.13.4 Poor Glycol Reconciliation	433
12.13.5 Low Glycol Circulation – Glycol Pump	433
12.13.6 High Pressure Drop Across Contactor	433
12.13.7 High Stripping Still Temperature	433
12.13.8 High Reboiler Pressure	433
12.13.9 Firetube Fouling/Hot Spots/Burn Out	433
12.13.10 High Gas Dew Points	433
12.13.11 Cause – Inadequate Glycol Circulation Rate	433
12.13.12 Low Reboiler Temperature	433
12.13.13 Flash Separator Failure	434
12.13.14 Cause – Insufficient Reconciliation of Glycol	434
12.13.15 Cause – Operating Conditions Different from Design	434
12.13.16 Cause – Low Gas Flow Rates	434
12.13.17 High Glycol Loss	434
12.14 Cause – Loss of Glycol Out of Still Column	434

12.15	The ADIP Process	435
12.16	Sour Water Stripping Process	435
	References	438
Glossary of Petroleum and Technical Terminology		441
Appendix A	Equilibrium K values	533
Appendix B	Analytical Techniques	547
Appendix C	Physical and Chemical Characteristics of Major Hydrocarbons	557
Appendix D	A List of Engineering Process Flow Diagrams and Process Data Sheets	573
Index		623

Preface

Petroleum refining is a complex industry that world-wide produces more than \$10 billion worth of refined products. Improvements in the design and operation of these facilities can deliver large economic value for refiners. Furthermore, economic, regulatory and environmental concerns impose significant pressure on refiners to provide safe working conditions and at the same time optimize the refining process. Refiners have considered alternative processing units and feedstocks by investing in new technologies.

The United States, Europe and countries elsewhere in the world are embarking on full electrification of automobiles within the next couple of decades. However, this venture still presents inherent problems of resolving rechargeable batteries and fuel cell and providing charging stations along various highways and routes. Oil and natural gas will for the foreseeable future form an important part of everyday life. Their availability has changed the whole economy of the world by providing basic needs for mankind in the form of fuel, petrochemicals, and feedstocks for fertilizer plants and energy for the power sector. Presently, the world economy runs on oil and natural gas, and processing of these feedstocks for producing fuels and value-added products has become an essential activity in modern society. The availability of liquefied natural gas (LNG) has enhanced the environment, and recent development in the technology of natural gas to liquids (GTL) has further improved the availability of fuel to transportation and other sectors.

The complex processing of petroleum refining has created a need for environmental, health and safety management procedures and safe work practices. These procedures are established to ensure compliance with applicable regulations and standards such as hazard communications (PHA, Hazops, MOC, and so on), emissions, Waste Management (pollution that includes volatile organic compounds (VOC), carbon monoxide, sulfur oxides (SO_x), nitrogen oxides (NO_x),

particulates, ammonia (NH₃), hydrogen sulfide (H₂S), and toxic organic compounds) and waste minimization. These pollutants are often discharged as air emissions, wastewater or solid wastes. Furthermore, concern over issues such as the depletion of the ozone layer that results in global warming is increasingly having a significant impact on Earth's nature and mankind, and carbon dioxide (CO₂) is known to be the major culprit of global warming. Other emissions such as H₂S, NO_x, and SO_x from petroleum refining have adversely impacted the environment, and agencies such as Occupational Safety and Health Administration (OSHA), and Environmental Protection Agency (EPA) have imposed limits on the emissions of these compounds upon refiners.

Flaring has become more complicated and concerns about its efficiency have been increasing and discussed by experts. The OSHA and EPA have imposed tighter regulations on both safety and emission control, which have resulted in higher levels of involvement in safety, pollution, emissions and so on.

Petroleum refinery is one of the important sectors of the world economy and it's playing a crucial and pivotal role in industrialization, urbanization, and meeting the basic needs of mankind by supplying energy for industrial and domestic transportation, feedstock for petrochemical products as plastics, polymers, agrochemicals, paints, and so on. Globally, it processes more materials than any other industry, and with a projected increase in population to around 8.1 billion by 2025, increasing demand for fuels, electricity, and various consumer products made from the petrochemical route is expected via the petroleum refining process.

Petroleum Refining Design and Applications Handbook, Volume One, comprises 12 chapters, a glossary of petroleum and technical terminology, appendices, Excel spreadsheet programs, UniSim-Design simulation software exercises, case studies and a Conversion Table. Chapters 1–4 comprise the chemistry and classification of crude types, physical property

characterization data; chemical analysis data; thermo physical properties of petroleum fractions and crude oils and thermodynamic properties of petroleum and petroleum fractions. Excel spreadsheet programs are extensively used in solving many exercises and case studies in these chapters. Chapter 5 provides process descriptions of refining processes from basic to complex processes, and chapters 6–9 describe conversion processes, hydrotreating and hydrocracking, catalytic and fluid catalytic cracking, hydrodesulfurization, coking, reforming and isomerization processes. UniSim-Design software, POLYMATH and Excel spreadsheet programs are used in solving exercises and case studies in these chapters. Chapter 10 reviews the alkylation and polymerization processes and introduces the new technology, and Chapter 11 discusses hydrogen production and purification. Chapter 12 focuses on gas processing and acid gas removal and UniSim-Design software is employed in the simulation of the gas processing and acid gas removal.

The book uses Honeywell UniSim-Design for steady-state simulation of some processes as most of

the concepts are also applicable to other systems. It provides spreadsheet programs for analysis and design; POLYMATH software for analysis and kinetics of some processes. Supporting materials available from the publisher's website provide simulation and spreadsheet files for all the models and examples presented in the book. Physical and chemical characteristics of major hydrocarbons are shown in Appendix C. There are process flow diagrams, P & IDs and nearly 50 process data sheets (Appendix D) in Excel spreadsheet format that can be readily accessed from the publisher's website.

The handbook covers fundamental theory of petroleum refining processes, practical problems and introducing new technology. It will be valuable for individuals who want to contribute to the development of refinery process simulation / modeling as well as those who wish to explore alternatives in the refining processes. This book will also be valuable to industrial practitioners, academic chemical / petroleum engineers, and engineering students in chemical and petroleum engineering courses. It can be used as a classroom text for such courses.

Acknowledgments

This project is a culmination of three years of research, collating relevant materials from organizations, institutions, companies and publishers, developing Excel spreadsheet programs and computer programs; using Honeywell's UniSim steady – state simulation program and providing majority of the drawings in the text.

Sincere gratitude to Honeywell Process Solutions for granting permission to incorporate the use of UniSim design simulation software in the book. Thanks also to Mr. Ahmed Mutawa formerly of SASREF Co., Saudi Arabia for developing the Conversion Table program for the book.

Many organizations, institutions and companies as Gas Processor Suppliers Association (GPSA), USA, Honeywell Process Solutions, Saudi Aramco Shell Refinery Co. (SASREF), Absoft Corporation, USA., American Institute of Chemical Engineers, Chemical Engineering magazine by Access Intelligence, USA and Hydrocarbon magazine have readily given permission for the use of materials and their release for publication. I greatly acknowledge and express my deepest gratitude to these organizations.

I have been privileged to have met with Phil Carmical, Publisher at Scrivener Publishing some sixteen years ago. Phil initiated the well- known Ludwig's project at the time during his tenure at Gulf Professional Publishing Co., and Elsevier, respectively. His suggestions in collaborating on this important works some six years ago were timely to the engineering community, as I hope that these works will be beneficial to this community world – wide. I'm deeply grateful to Phil for agreeing to collaborate with me, his suggestions and assistance since.

I also wish to express my thanks to the Wiley-Scrivener team: Kris Hackerott – Graphics Designer, Bryan Aubrey – Copyeditor and Exeter – Typesetters. I am truly grateful for your professionalism, assistance and help in the production of this volume.

***Finally,
Without Him, I am nothing
Life is in God alone
In Him alone is the energy that lies in life.***

A. Kayode Coker

About the Author

A. Kayode Coker PhD, is Engineering Consultant for AKC Technology, an Honorary Research Fellow at the University of Wolverhampton, U.K., a former Engineering Coordinator at Saudi Aramco Shell Refinery Company (SASREF) and Chairman of the department of Chemical Engineering Technology at Jubail Industrial College, Saudi Arabia. He has been a chartered chemical engineer for more than 30 years. He is a Fellow of the Institution of Chemical Engineers, U.K. (C. Eng., FIChemE), and a senior member of the American Institute of Chemical Engineers (AIChE). He holds a B.Sc. honors degree in Chemical Engineering, a Master of Science degree in Process Analysis and Development and Ph.D. in Chemical Engineering, all from Aston University, Birmingham, U.K. and a

Teacher's Certificate in Education at the University of London, U.K. He has directed and conducted short courses extensively throughout the world and has been a lecturer at the university level. His articles have been published in several international journals. He is an author of five books in chemical engineering, a contributor to the Encyclopedia of Chemical Processing and Design, Vol 61, and a certified train – the mentor trainer. A Technical Report Assessor and Interviewer for chartered chemical engineers (IChemE) in the U.K. He is a member of the International Biographical Centre in Cambridge, U.K (IBC) as Leading Engineers of the World for 2008. Also, he is a member of International Who's Who for Professionals™ and Madison Who's Who in the U.S.

1

Introduction

Petroleum and natural gas have been the essential source of energy production worldwide, greater than nuclear and alternative sources such as solar, wind and geothermal. With globalization, global energy demand will continue to increase for the foreseeable future. Oil and natural gas will continue to supply a majority of the world's energy needs, and the production will be from natural sources of petroleum, coal and natural gas. The U.S. has an estimated 260 billion tons of recoverable coal, equivalent to three or four times as much energy in coal as Saudi Arabia has in oil [1]. This increase requires the exploitation of conventional and unconventional reservoirs of oil and gas in an environmentally friendly manner that requires advances in technology and materials in the form of better catalysts to produce clean fuels.

The National Petroleum Council (NPC) in the U.S. [2] indicates that the total global demand for energy will grow by 50 – 60% by 2030 due to the increase in world population, and the average standards of living in the developing countries. Therefore, oil, gas and coal will continue to be the primary energy sources notwithstanding the discovery of bio-fuels such as bio-ethanol for the twenty-first century. Further, the energy industry will require an increase in the supply of hydrocarbon resources to meet these demands.

The volumes of oil and natural gas located in unconventional reservoirs are much larger than the conventional reservoirs, which are currently used for what has been produced. Unconventional oil and gas are generally difficult and expensive to extract, and may present a more negative environmental impact than conventional reserves. Examples of unconventional oil sources are extra heavy oil, oil sands, tight sands, oil shale, etc. Extracting oil and gas from unconventional reservoirs requires developing new technology that enables the industry to produce oil and gas in an environmentally acceptable manner. Carbon dioxide (CO₂) sequestration and environmentally friendly processes will form a prominent aspect of developing new resources. Throughout these processes, development of materials of construction for the facilities, especially those that can withstand high-temperature, high-pressure and high-stress conditions will be essential to the entire industry [3].

The recent low oil price (U.S. \$55/bbl) in 2015, unlike 2008, is triggered by:

- A weak demand growth, particularly in China and Europe.
- Strong non-OPEC supplied growth, particularly from U.S. tight oil.

- OPEC’s behavior as it has maintained production to retain market share.

The global demand for oil in 2000 was 76 million barrels per day (bbls per day), while currently oil production is about 86 million bbls per day (40,000 gallons per second) or 31.4 billion barrels per year. The NPC estimates that the demand for oil will be 103–138 millions bbls per day or 37.6–50.4 billions bbls per year by 2030. Global conventional oil reserves are mainly in the Middle East, and the seven countries with the largest conventional oil reserves account for more than 70% of the world total. Saudi Arabia holds 20% of the conventional reserves [3].

In the early 1990s, Saudi Arabia held 18.9% of the global crude oil/refined product export market. The market share fell to a low 12.4% in 2014, which notably is the same market share when OPEC took a stance and flooded the international oil market with the goal to control its market share as in 1986. The mid-1980s were disappointing and unprofitable for both the upstream and downstream until corrections in supply and demand lifted oil pricing to an agreeable level for producers as Saudi Arabia and OPEC.

Figure 1.1 shows Wood Mackenzie’s global demand outlook, and first-quarter and second-quarter 2015 demand levels projected to be lower than that of the fourth-quarter 2014, reflecting seasonality and refinery maintenance. U.S. tight oil is the most responsive supply source that requires drilling a large number of wells, each of which declines rapidly. Low oil prices will impact the growth from this supply source, which will eventually resolve in returning the oil market back into balance. Refining industry margins and crude runs have been supported by the declining oil price

during the second half of 2014, as oil product prices have reduced as shown in Figure 1.2.

Refiners are encountering a dynamic business environment as crude prices are volatile, heavy, high-sulfur and acidic opportunity crudes are increasingly available. Demand for lighter products is increasing, product legislation and emissions standards are tightening and health, safety and environment mandates also have to be met.

The demand for transportation fuels continues to increase, which is driven by the expanding economies of developing nations in Asia-Pacific, the Middle East and Latin America, and global demand for crude oil is forecast to exceed 94 MMbpd in 2015. Presently there are over 640 refineries that are operating globally and the refining industry is struggling with excess capacity. Demand for transportation fuels is shifting toward other middle distillates and diesel. Figure 1.3 shows a map of the world crude oil reserves.

Refining Processes and Operations

Crude oil in its natural state has no value to consumers unless it is processed into products that are marketable. Various physical and chemical methods are employed in the refining processes. These methods apply process conditions as temperature, pressure, catalysts, heat and chemical reactions to convert crude oil and other hydrocarbons into petroleum products.

Refining commences with distillation by boiling crude into separate fractions or cuts. All crude oils undergo separation processes through distillation and the capacity of a refinery is expressed in terms of its distillation capacity. Two measures are commonly used: barrels per stream day (bpsd) and barrels per

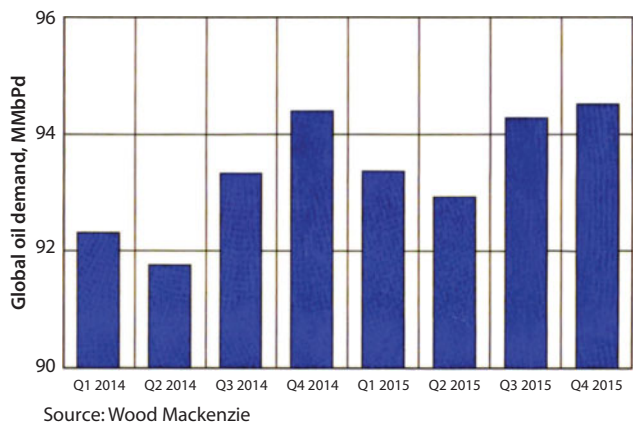


Figure 1.1 Quarterly global demand outlook 2014 – 2015 (Source: Gelder, Alan, pp 25. *Hydrocarbon Processing*, February 2015 [4]).

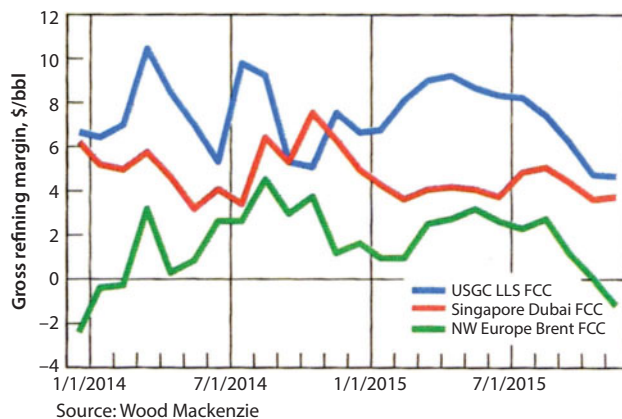


Figure 1.2 Regional gross refining margins, US\$/bbl. (Source: Gelder, Alan, *Hydrocarbon Processing*, pp 25, February 2015 [4]).

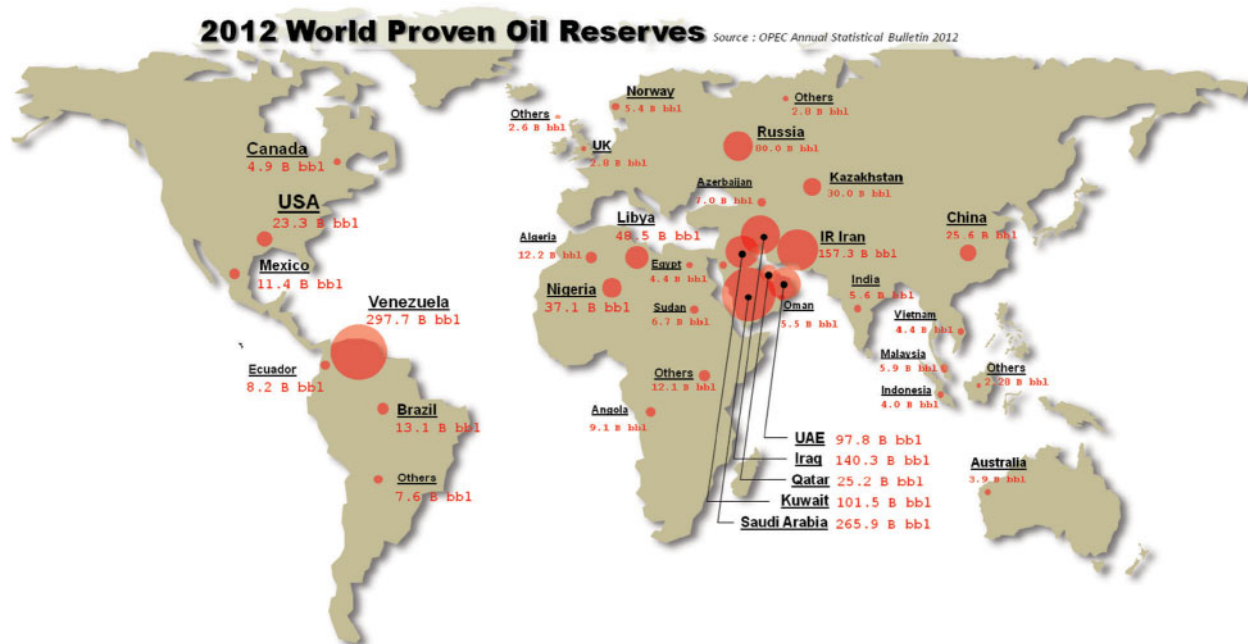


Figure 1.3 World oil reserves. (Source: OPEC Annual Statistical Bulletin, 2012).

calendar day (bpcd). A barrel per stream day is the maximum number of barrels of input that a distillation facility can process when running at full capacity under optimal crude and product slate conditions with no allowance for downtime. A barrel per calendar day is the amount of input that a distillation facility can process under usual operating conditions, making allowances for the types and grades of products to be manufactured, environmental constraints, scheduled and unscheduled downtime due to maintenance, repairs and shutdown. Table 1.1 shows the world's largest refiners with their intakes of crudes of thousand bbls per calendar day.

After the crude is separated into its fractions, each stream is further processed by changing the size and structure of the molecules through heating, cracking, reforming and other conversion processes. The converted products are then subjected to further treatments and separation processes to remove undesirable constituents and improve product quality. Petroleum refining processes and operations are classified into five basic types [5]:

1.	Distillation	Is the separation of crude oil in atmospheric and vacuum distillation columns into groups of hydrocarbon compounds based on molecular size and boiling-point ranges.
----	--------------	--

2.	Conversion	Processes change the size or structure of hydrocarbon molecules by: Decomposition: Breaking down large molecules into smaller molecules with lower boiling points through cracking and related processes. Unification: Building small molecules into larger molecules through alkylation, polymerization, and related processes. Reforming: Rearranging molecules into different geometric structures in isomerization, catalytic reforming, and related processes.
3.	Treatment	Processes prepare hydrocarbon streams for additional processing and to prepare finished products using chemical or physical separation. Processes include desalting, hydrodesulfurization, solvent refining, sweetening, solvent extraction and dewaxing.
4.	Blending	Process of mixing and combining hydrocarbon fractions, additives, and other components to produce finished products with specific performance properties.
5.	Other refining operations	Include light-ends recovery, sour-water stripping, solid waste and wastewater treatment, process-water treatment and cooling, storage and handling, product movement, hydrogen production, acid and tail gas treatment, and sulfur recovery.

Table 1.1 shows the world's largest refiners.

Rank by capacity	Company	Crude capacity thousand barrels per calendar day
1	Exxon Mobil Corporation (USA)	5,589
2	Royal Dutch / Shell (Netherlands)	4,109
3	Sinopec (China)	3,971
4	BP, plc (United Kingdom)	2,859
5	Saudi Arabian Oil Company (Saudi Arabia)	2,852
6	Valero Energy Company (USA)	2,777
7	Petroleoes de Venezuela. S.A. (Venezuela)	2,678
8	China National Petroleum Company (China)	2,675
9	Chevron Corporation (USA)	2,540
10	Phillips 66 (USA)	2,514
11	Total S.A. (France)	2,304
12	Petroleo Brasileiro S.A. (Brazil)	1,997
13	Marathon Oil Corp (USA)	1,714
14	Petroleos Mexicanos (Mexico)	1,703
15	National Iranian Oil Company (Iran)	1,451
16	JX Nippon Oil & Energy Corp (Japan)	1,423
17	Rosneft (Russia)	1,293
18	AO Lukoil (Russia)	1,217
19	SK Innovation (South Korea)	1,115
20	Repsol YPF S.A. (Spain)	1,105
21	Kuwait National Petroleum Corporation (Kuwait)	1,085
22	Pertamina (Indonesia)	993
23	Agip Petroli SpA (Italy)	904
24	Flint Hills Resources	714
25	Sunoco Inc. (USA)	505

¹Rank as of January 1, 2014

Source: "Western Europe leads global refining contraction," *Oil & Gas Journal*, December 2, 2013.

Generally, refineries operate under complex systems that involve physical laws and engineering specifications, the economic principles that guide investment and operating requirements, rules governing production activities and product specifications. Complex interrelationships exist among the physical laws by which a system operates, the product demands required by the market, the rules and regulations established for the system. Figure 1.4 shows a typical refinery flow scheme.

Refinery – Petrochemical Integration

The growth of the petrochemical industry has imposed pressure on refineries to either alter their configuration or operating conditions to produce more aromatics and gases. Fluid catalytic cracking (FCC) has been developed to petrochemical FCC, which produces a high yield of gases. The idea of increasing the octane number by increasing aromatic content has changed the role of the catalytic reformer to produce a high

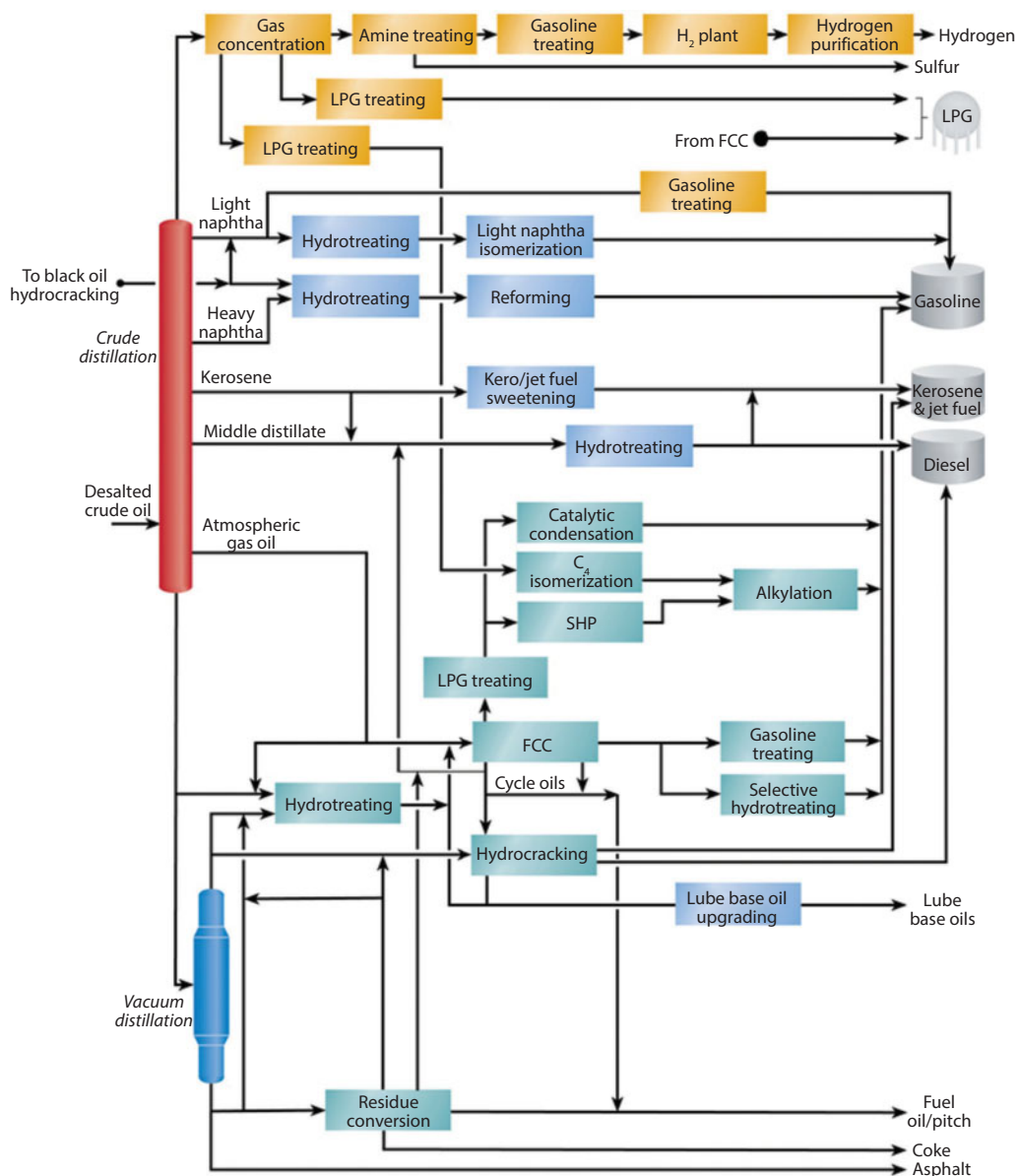


Figure 1.4 Refining flow scheme (source: UOP – A Honeywell Co.)

yield of aromatics as benzene, toluene and xylene (BTX) feedstock. The addition of gasification units to process vacuum residue has ensured the addition of a variety of petrochemicals. Some process industries now integrate both refinery and petrochemical facilities to maximize their product specifications, save energy, meet environmental regulations and maximize profits. Figure 1.5 shows a petrochemical flow scheme.

New technologies/methodologies are increasingly sought such as improved catalysts for greater yield of the products, energy management and process integration of refinery facilities, and adherence to environmental

regulations, process hazard analysis metric standards, tracking of fugitive emissions of hydrocarbons from flanges, valves and fittings, pollution control equipment of gases as SO_x , CO , CO_2 , NO_x , VOC , H_2S , hydrocarbons and particulates and improving flaring of gaseous hydrocarbon. Health, safety and environmental issues have formed an essential part of the refinery operation as operators' errors or equipment malfunction or a combination of these have resulted in deaths, damage to facilities, diminished company's reputation and substantial loss in revenues. Other factors that may influence the refinery configuration are feedstock availability, product markets and the company's strategic objectives. Design

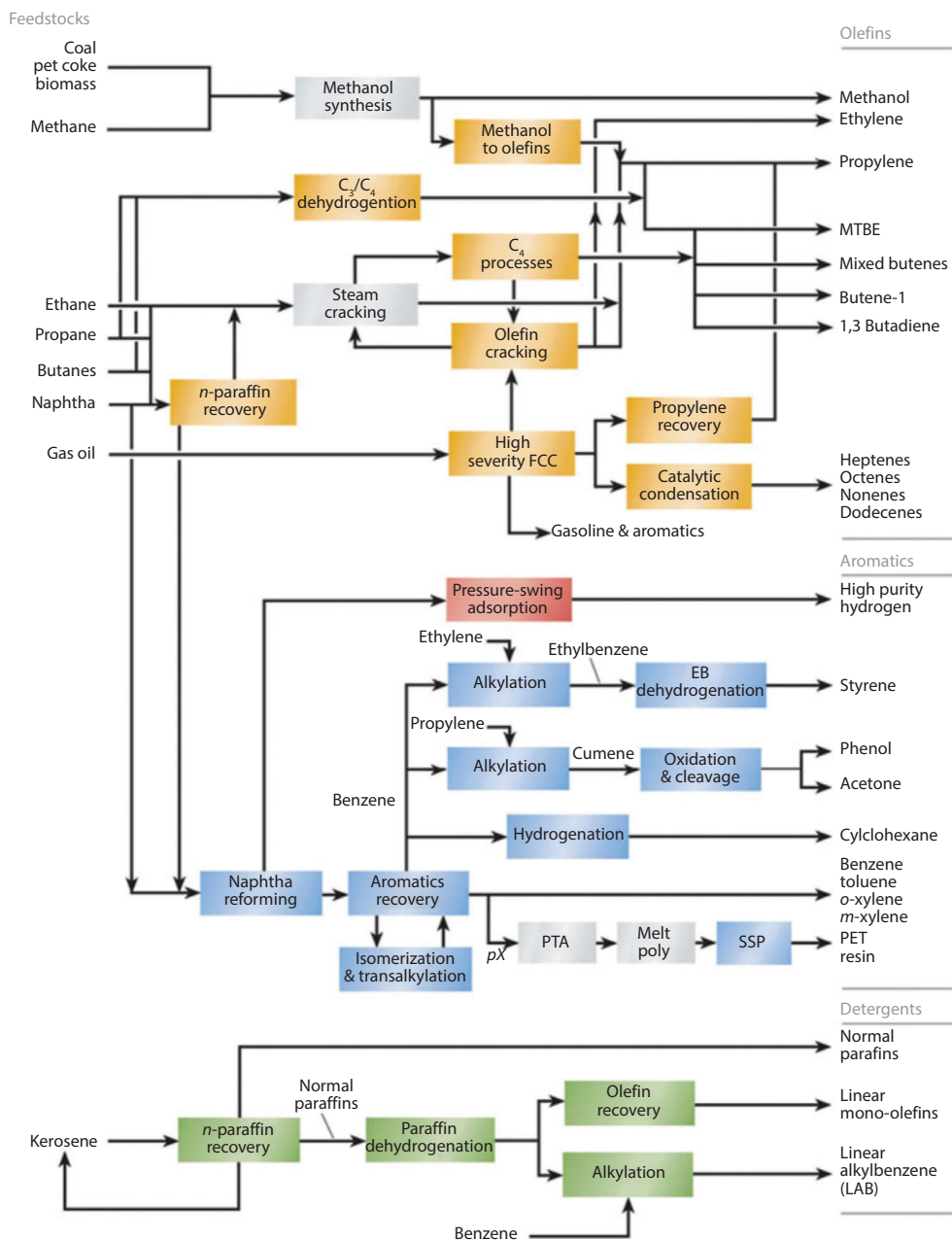


Figure 1.5 Petrochemical flow scheme (Source: UOP – A Honeywell Co.)

methodologies and various aspects of safety issues are featured in volumes 1 and 2 of these works.

References

1. <http://www.americanenergyindependence.com/hydrocarbons.aspx>
2. NPC., "Facing the Hard Truths about Energy – A Comprehensive View to 2030 of Global Oil and Natural Gas, National Petroleum Council, Washington D.C., www.npc.org, 2007.
3. Chianelli, Russel, R., Kretschmer, Xiomara C., and Stephen A. Holditch, "Petroleum and natural gas", *Fundamentals of Materials for Energy and Environmental Sustainability*, Eds. David S. Ginley and David Cahen, Cambridge, Materials and Research Society.
4. Gelder, Alan, pp 25. *Hydrocarbon Processing*, February, 2015.
5. OSHA technical manual in Petroleum Refining Processes, U.S. Department of Labor, Occupational Safety and Health Administration, Washington, D.C., sec. IV, Chapt. 2, 2005.

2

Composition of Crude Oils and Petroleum Products

Introduction

Petroleum or crude oil is a naturally occurring oily, bituminous liquid comprising various organic and inorganic chemicals, and is found in large quantities below the surface of the earth and is used as fuel and raw material in the chemical process industry (CPI). Modern industrial societies use it primarily to achieve a degree of mobility as a fuel in internal combustion and jet engines. Additionally, petroleum and its derivatives are employed in the manufacture of plastics, paints, fertilizers, building materials, medicines, and clothing and to generate electricity.

Petroleum is formed under the earth's surface by the decomposition of organic material. It's the remains of tiny organisms that lived in the sea, and to a lesser extent those of land organisms that were carried down to the sea in rivers along with plants that grow in the ocean bottoms combined with the fine sands and silts in calm sea basins. These deposits, which are rich in organic materials, become the source rocks in the formation of carbon and hydrogen, i.e., natural gas and crude oil.

The process began many millions of years ago with the development of abundant life, and it continues to this day. The sediments grow thicker and sink to the bottom of the sea bed and as additional deposits pile up, the pressure on the ones below increases several thousand times, and the temperature rises by several hundred degrees. Subsequently, the mud and sand harden into shale and sandstone. Carbonate precipitates, and skeletal shells harden into limestone. The remains of the dead organisms are transformed into crude oil and natural gas. The underground and formation pressure are sufficient for the natural release of hydrocarbon liquids and gases to the surface of the earth.

Basics of Crude Oil

Crude oils are complex mixtures containing many different hydrocarbon compounds that vary in appearance and composition from one oil field to another. Crude oils range in consistency from water to tar-like solids, and in color from clear to black. An average crude oil contains about 84% carbon, 14% hydrogen,

1%–3% sulfur, and less than 1% each of nitrogen, oxygen, metals, and salts. Crude oils are generally classified as paraffinic, naphthenic, or aromatic, based on the predominant proportion of similar hydrocarbon molecules. Mixed-base crudes have varying amounts of each type of hydrocarbon. Refinery crude base stocks usually consist of mixtures of two or more different crude oils.

Relatively simple crude oil assays are used to classify crude oils as paraffinic, naphthenic, aromatic, or mixed. One assay method (United States Bureau of Mines) is based on distillation, and another method Universal Oil Product characterization factor (K_{UOP} factor) is based on gravity and boiling points. More comprehensive crude assays determine the value of the crude (i.e., its yield and quality of useful products) and processing parameters. Crude oils are usually grouped according to yield structure; characterizations of crude oils are illustrated in chapter 3.

Basics of Hydrocarbon Chemistry

Crude oil is a mixture of hydrocarbon molecules, which are organic compounds of carbon and hydrogen atoms that may include from one to 60 carbon atoms. The properties of hydrocarbons depend on the number and arrangement of the carbon and hydrogen atoms within the molecules. The simplest hydrocarbon molecule is one carbon atom linked with four hydrogen atoms: methane. All other variations of petroleum hydrocarbons evolve from this molecule.

Hydrocarbons containing up to four carbon atoms are usually gases; those with 5 to 19 carbon atoms are liquids, and those with 20 or more are solids. The refining process uses chemicals, catalysts, heat, and pressure to separate and combine the basic types of hydrocarbon molecules naturally found in crude oil into groups of similar molecules. The refining process also rearranges their structures and bonding patterns into different hydrocarbon molecules and compounds. Therefore, it is the type of hydrocarbon (paraffinic, naphthenic, or aromatic) rather than its specific chemical compounds that are significant to the refining process.

There are many different types of crude ranging in complexity from one reservoir to another. Crude oil is graded by a specific viscosity range from 0.7–1.0 and indicated as degree of American Petroleum Institute ($^{\circ}$ API), which varies 5.0–70. The higher degrees are referred to as lighter crudes and lower degrees as heavier crudes. Clearly, the specific gravity reflects the

compositions of chemical families that are very different from each other.

Pure Components

Crude oils are mixtures of pure components, but these are extremely numerous and the difficulty of describing the different fractions increases with the number of carbon atoms. All crude oils differ in the fractions of the various hydrocarbons they contain. The specific molecules vary in shape and size from C_1 to C_{80} or more.

At the simplest, the once carbon compound has four hydrogen atoms bonded to the carbon atom to produce the compound methane gas (CH_4). Liquid hydrocarbons from natural wells may have nitrogen, oxygen, and sulfur quantities from trace amounts to significant as well as trace of metals such as nickel (Ni), vanadium (V), titanium (Ti), iron (Fe), etc. Natural petroleum is distilled and reformulated to produce a variety of fuels for general use and as raw feedstock materials for other industries.

2.1 Hydrocarbons

Crude oils and high-boiling crude oil fractions are composed of many members of a relatively few homologous series of hydrocarbons. The composition of the total mixture does not vary widely, but small differences in composition can greatly affect the physical properties, and the processing required in producing saleable products. Petroleum is essentially a mixture of hydrocarbons, and even the non-hydrocarbon elements are generally present as components of complex molecules, predominantly hydrocarbon in character, but containing small quantities of oxygen, sulfur, nitrogen, vanadium, nickel, and chromium. The hydrocarbons present in crude petroleum are classified into three general types: paraffin, naphthenes, and aromatics. Additionally, there is the fourth type, olefins, that are formed during processing of the crude by cracking or dehydrogenation of paraffins and naphthenes; olefins are not present in crude oils. Figure 2.1 shows the general classification of hydrocarbons.

The characteristics of matter depend on the types of atoms that make it up and how they are attached to each other in groups called molecules. There are rules by which atoms can be arranged into molecules. The most important rules have to do with valences and bonds.

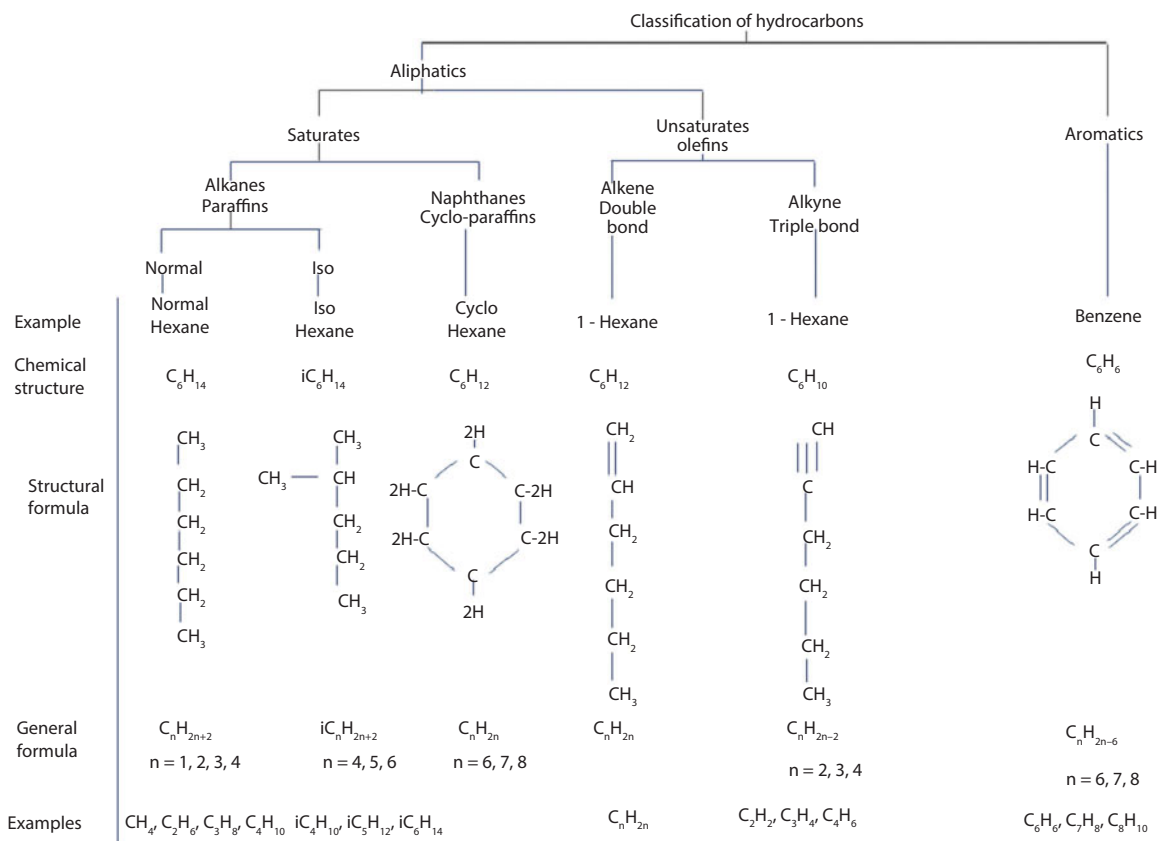


Figure 2.1 Classification of hydrocarbons.

Valences: Each type of atom (element) has an affinity of other elements according to its atomic structure. For example, carbon atoms would always like to attach themselves to four other atoms. Hydrogen atoms would always like to attach themselves to only one other atom. By definition, the valence of an atom of any element is equal in the number of other atoms that the atom has a propensity to combine with.

Bonds: The connection between two atoms is called a bond.

Crude oil can be classified into the following main classes: the paraffins, the asphaltic and the mixed based. The paraffins are composed of molecules in which the number of hydrogen atoms is always two more than twice the number of carbon atoms. The characteristic molecules in the asphaltic types are naphthenes, composed of twice as many hydrogen atoms as carbon atoms. In the mixed-based types are both paraffins hydrocarbon and naphthenes.

The saturated open-chain hydrocarbons form a homologous series called the paraffin series or the alkane series. The composition of each of the members of the series corresponds to the formula C_nH_{2n+2} , where

n is the number of carbon atoms in the molecule. All the members of the series are unreactive. That is, they do not react readily at ordinary temperatures with such reagents as acids, alkalis or oxidizers. The first four carbon molecules, C_1 to C_4 with the addition of hydrogen are gases: methane (CH_4), ethane (C_2H_6), propane (C_3H_8) and butane (C_4H_{10}). Larger molecules are C_5 to C_7 : pentane (C_5H_{12}), hexane (C_6H_{14}), heptane (C_7H_{16}) cover the range of light gasoline liquids. C_8 to C_{11} are naphthas; C_{12} to C_{19} , kerosene and gas oil, C_{20} to C_{27} lubricating oils, and above C_{28} heavy fuels, waxes, asphalts, bitumen and materials as hard as stone at normal temperatures. Accompanying the gas compounds may be various amounts of nitrogen, carbon dioxide, hydrogen sulfide and occasionally helium.

Structures of Saturated Aliphatic Hydrocarbons or Paraffins or Alkanes

The simplest example of valence, bonds and hydrocarbons is methane (CH_4), which has one carbon atom surrounded by four hydrogen atoms. The next

hydrocarbon is ethane (C_2H_6), where the carbon atom is attached to another carbon atom and surrounded by hydrogen atoms, and each uses the same bond to satisfy its valence need. The whole class of hydrocarbons can be defined by extending the relationship from methane to ethane and beyond. These molecules are paraffins or straight chain compounds and have the general formula C_nH_{2n+2} , where $n = 1, 2, 3, 4, 5, 6, 7$, etc., the number of carbon atoms. They can be structured as straight chains as are the normal paraffins or n-alkanes, and they are described by the following formula: $CH_3 - (CH_2)_n - CH_3$.

Other molecules of the hydrocarbons or alkanes are propane (C_3H_8), normal butane (nC_4H_{10}), normal pentane (nC_5H_{12}), hexane (C_6H_{14}) and heptane (C_7H_{16}). Here, the prefix normal refers to straight chains hydrocarbons as shown in Figure 2.1a.

Their boiling points increase with the number of carbon atoms. For molecules of low carbon numbers, the addition of a carbon increases the boiling point about 25 °C. Further additions result in a smaller increase. The density increases with the molecular weight: 0.626 kg/l for pentane which has 5 carbon atoms, 0.791 kg/l for pentacosane which has 25 carbon atoms, but the density is always much lower than 1.0.

There are several ways of arranging the straight chain carbon atoms of the alkanes. When the number of carbon atoms in the molecule is greater than three, several hydrocarbons may exist that contain the same

number of carbon and hydrogen atoms but have different structures. This is because the carbon is capable of not only straight chain formation, but also of forming single or double branched chains that give rise to isomers that have significantly different properties. In this instance, one or more hydrogen atoms can be substituted by a carbon atom or chain of hydrocarbons or where there is a branch off of one of the inside carbons. In this case, the compounds are referred to as isoparaffins or isoalkanes. The number of possible isomers increases in geometric progression as the number of carbon atoms increases. There are two paraffin isomers for butane, three for pentane and 17 structural isomers of octane and by the time the number of carbon atoms has increased to 18, there are 60,553 isomers of cetane. Crude oil contains molecules with up to 70 carbon atoms, and the number of possible paraffinic hydrocarbons is very high. Figure 2.2 shows branched chain hydrocarbons.

The branching can take place at different locations in the chain, giving the possibility for equal numbers of carbon atoms; different molecules called isomers. Isomerization and carbon's valence of four are the major reasons why there are almost a million identified different hydrocarbon compounds. Even though normal butane and isobutane have the same molecular formula, they behave differently. They boil at different temperatures; they have different gravities (since they are packed differently); they cause different chemical

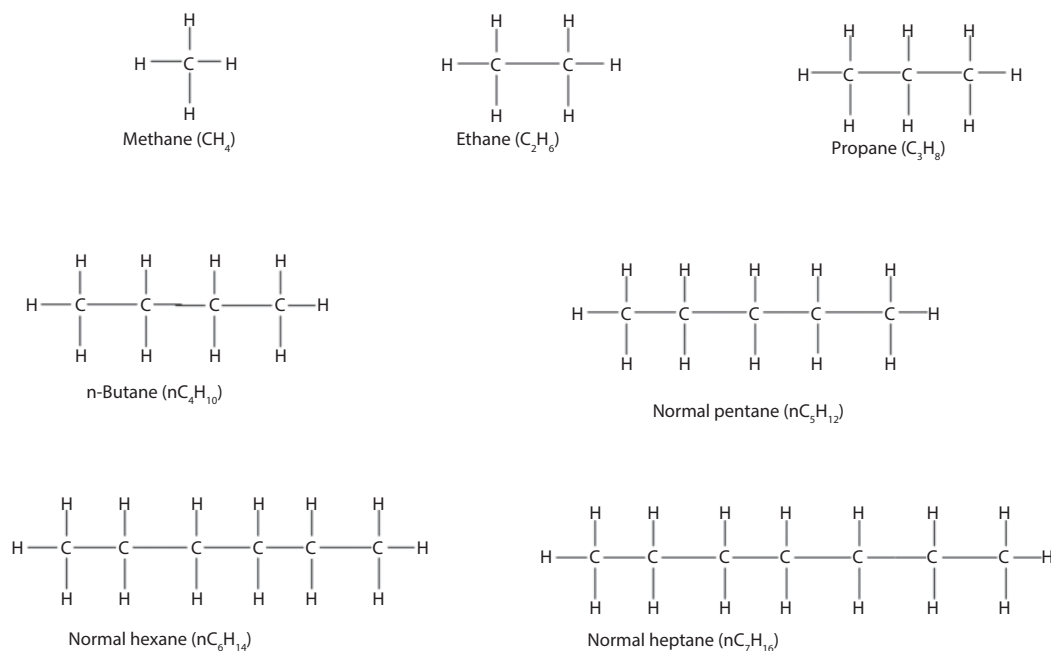


Figure 2.1a Straight chain hydrocarbon compounds.

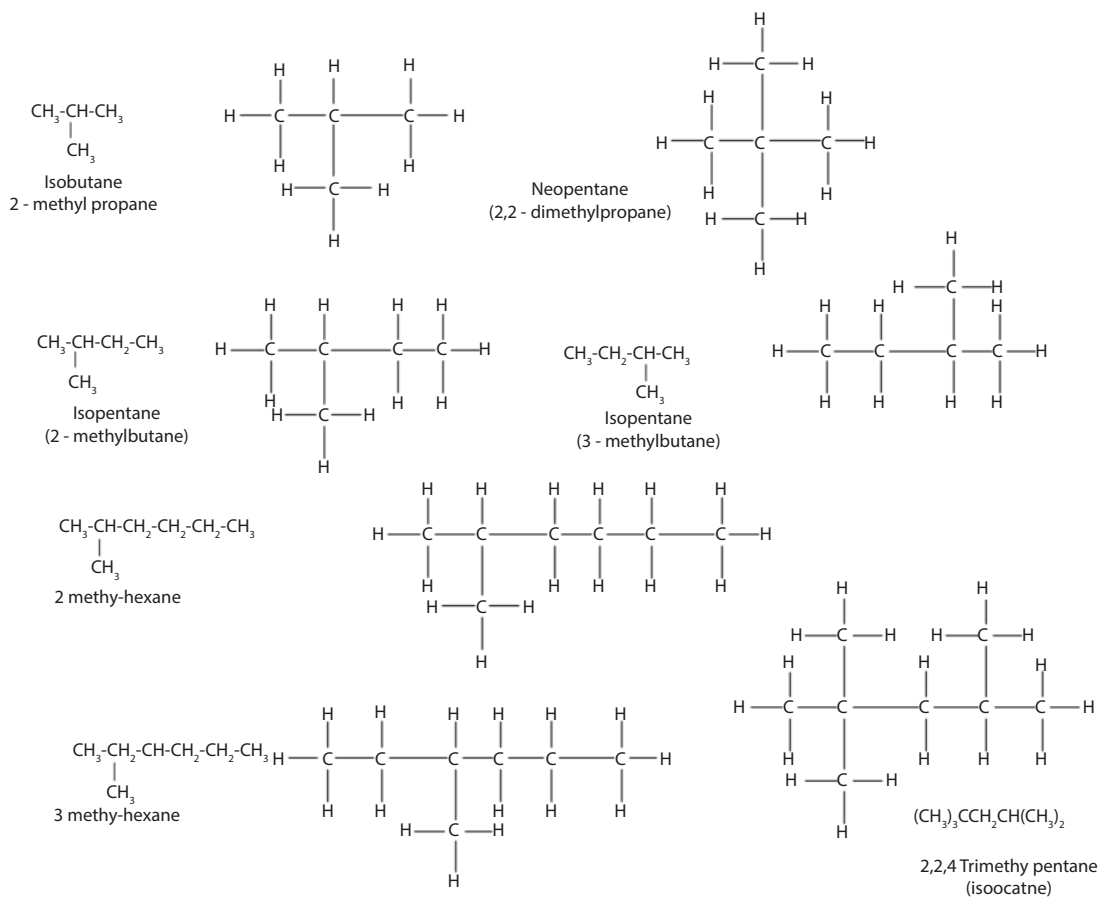


Figure 2.2 Branched chain aliphatic compounds.

reactions, which will be important in a later chapter on alkylation. Generally, isoparaffins have boiling points lower than normal paraffins with the same number of carbon atoms. The motor octane number of n-octane is 17 and that of isooctane (2, 2, 4 - trimethyl pentane) is 100. Table 2.1 presents some physical properties of selected paraffins.

Unsaturated Aliphatic Hydrocarbons or Olefins or Alkenes

It is possible to have a compound with two carbon atoms and four hydrogen atoms. However, that would seem to violate the valence rules, but the alkenes series are made up of chain hydrocarbons in which a double bond exists between the two carbon atoms. This makes up for the deficiency of the hydrogen atoms. Ironically, the double bond that holds the two carbons together is weaker, not stronger than a single bond. Those carbon atoms on either side desperately want to find some

other atoms to satisfy the valence of four. A compound with double-bonded carbon is therefore, more chemically reactive than its paraffin counterpart and can be reacted with some other reactive compound or atom with relative ease, eliminating the double bond.

The key characteristic of the olefin is the double bond between the two carbon atoms, and the absence of two hydrogen atoms form an otherwise saturated paraffins (i.e., paraffin that has a full complement of hydrogen atoms). The general formula for the series is C_nH_{2n} , where n is the number of carbon atoms (n = 2, 3, 4, 5 etc.). As in the paraffin series, the lower numbers are gases, intermediate compounds are liquids, and the higher numbers of the series are solids. The alkenes series compounds are more active chemically than the saturated compounds. They react easily with substances such as halogen by adding atoms at the double bonds.

They are not found in natural products, but are produced in the destructive distillation of complex natural substances, such as coal, and formed in large amounts

Table 2.1 Physical constants of selected alkanes

Alkanes	Overall formula	Structural formula*	Molecular weight	Boiling point, °C (1 atm)	Specific gravity d_4^{15} (liquid)
Methane	CH ₄	C	16.0	-161.5	0.260
Ethane	C ₂ H ₆	C-C	30.1	-88.6	0.377
Propane	C ₃ H ₈	C-C-C	44.1	-42.1	0.508
n-Butane	nC ₄ H ₁₀	C-C-C-C	58.1	-0.5	0.585
Isobutane	iC ₄ H ₁₀	$\begin{array}{c} \\ \text{C}-\text{C}-\text{C} \end{array}$	58.1	-11.7	0.563
n-Pentane	nC ₅ H ₁₂	C-C-C-C-C	72.1	+36.1	0.631
Isopentane	iC ₅ H ₁₂	$\begin{array}{c} \text{C}-\text{C}-\text{C}-\text{C} \\ \end{array}$	72.1		
n-Hexane	nC ₆ H ₁₄	C-C-C-C-C-C			
n-Heptane	nC ₇ H ₁₆	C-C-C-C-C-C-C	100.2	98.4	0.688

*Hydrogen atoms are omitted to simplify illustration.

in petroleum refining, particularly in the cracking process. Olefins are generally undesirable in finished products because the double bonds are reactive, and the compounds are more easily oxidized and polymerized to form gums and varnishes. In gasoline boiling range fractions, some olefins are desirable because olefins have higher octane numbers than paraffins compounds with the same number of carbon atoms. Olefins containing five carbon atoms have high reaction rates with compound in the atmosphere that form pollutants and even though they have high research octane numbers are considerably generally undesirable.

The first member of the series is ethylene (C₂H₄) and following the homologous series are the propylene (C₃H₆), butylene (C₄H₈). The dienes contain two double bonds between pairs of carbon atoms in the molecule. They are related to the complex hydrocarbons in natural rubber and are important in the manufacture of synthetic rubber and plastics. The most important members of this series are butadiene (C₄H₆) and isoprene (C₅H₈). The olefins that are of primary interest in petroleum refining are propylene (C₃H₆) and butylenes (C₄H₈). Like ethylene, these compounds can be reacted with other chemicals relatively easily and so are suitable for applications in refinery (the alkylation process), and in petrochemical applications (e.g., manufacture of polypropylene, polybutylene, etc.). There are many more olefins in the stream that come from catalytic crackers, thermal crackers and Coker units. There are never enough hydrogen atoms in these crackers to fill out the carbons of the smaller molecules that result from cracking larger ones.

Taking into account the double bond, an olefin situation is encountered that is much more complex than that of the preceding families. For example, the butylene isomers (C₄H₈) have several arrangements:

• 1 - butene	CH ₂ = CH - CH ₂ - CH ₃
• cis 2 - butene	$\begin{array}{c} \text{CH}_3 - \text{C} = \text{C} - \text{CH}_3 \\ \quad \\ \text{H} \quad \text{H} \end{array}$
• trans 2 - butene	$\begin{array}{c} \text{H} \\ \\ \text{CH}_3 - \text{C} = \text{C} - \text{CH}_3 \\ \\ \text{H} \end{array}$
• isobutene	$\begin{array}{c} \text{CH}_3 \\ \diagdown \\ \text{C} = \text{CH}_2 \\ \diagup \\ \text{CH}_3 \end{array}$

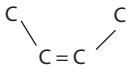
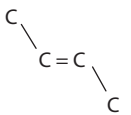
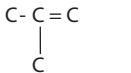
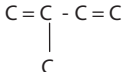
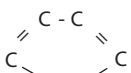
The terms cis and trans signify, respectively that the two hydrogen atoms are on the same side or on the opposite side with respect to the perpendicular plane of the double bond. Table 2.2 shows the physical properties of selected unsaturated hydrocarbons.

In general, there are little or no olefins in crude oil or "straight run" (direct from crude distillation) products but they are found in refining products, particularly in the fractions coming from conversion of heavy fractions whether or not these processes are thermal or catalytic.

2.1.1 Alkynes Series

The members of the alkynes series contain a triple bond between two carbon atoms on the molecule. They are

Table 2.2 Physical properties of unsaturated hydrocarbons.

Alkenes	Overall formula	Structural formula*	Molecular weight	Boiling point, °C (1 atm)	Specific gravity d_4^{15} (liquid)
Ethylene	C_2H_4	$C = C$	28.0	-103.7	
Propylene	C_3H_6	$C - C = C$	42.1	-47.7	0.523
1 - Butylene	C_4H_8	$C = C - C - C$	56.1	-6.3	0.601
cis 2 butene	C_4H_8		56.1	+3.7	0.627
Trans 2 - butene	C_4H_8		56.1	0.8	0.610
Isobutene	C_4H_8		56.1	-6.9	0.601
1 - Pentene	C_5H_{10}	$C = C - C - C - C$	70.1	+30.0	0.646
1, 3 Butadiene	C_4H_6	$C = C - C = C$	54.1	-4.4	0.627
Isoprene	C_5H_8		68.1	34.1	0.686
Cyclopentadiene	C_5H_6		66.0	40.0	

* Hydrogen atoms are omitted to simplify illustration.

very active chemically and are not found free in nature. They form a series analogous to the alkenes series with a general formula $C_n H_{2n-2}$, where n is the number of carbon atoms ($n = 2, 3, 4$, etc.). The first and most important member of this series is acetylene, C_2H_2 .

Cyclic Hydrocarbons or Cycloparaffins/ Cycloalkanes or Naphthenes

Another class of hydrocarbons found in crude oil is naphthenes. They are saturated hydrocarbons containing cyclic (or ring) structures with a general formula $C_n H_{2n+2-2R_N}$, where R_N stands for the number of naphthenic rings. On average, crude oil contains about 50% by weight of naphthenes. The rings most frequently encountered in crude oils are those having five or six carbon atoms. In these rings, each hydrogen atom can be substituted by a paraffinic "alkyl" chain that is either a straight chain or branched. Their boiling points and densities are higher than alkanes having the same number of carbon atoms. There are many types of naphthenes present in crude oil, but except for the lower-molecular weight compounds such as cyclopentane

(C_5H_{10}), and cyclohexane (C_6H_{12}), they are generally not handled as individual compounds. They are classified according to boiling range and their properties are determined by correlation factors such as the K_w factor or Cetane index. Cyclopentanes, cyclohexanes and their alkyl derivatives are the major naphthenes found in petroleum; methyl cyclopentane and methyl cyclohexane alone constitute more than 2% of the average crude. There also exist cycloparaffins with two, three or four, etc., rings attached. Hence, decalin has two rings attached to each other and the general formula is $C_{10}H_{18}$. Figure 2.3 shows the structures of the naphthenes.

Beyond the simple paraffins and cyclic hydrocarbons, an infinite variety of possibilities can occur by connecting two or more types of compounds. The least complicated and simplest example is methyl cyclopentane, which is the connection of $-CH_3$, referred to as methyl group and a cyclopentane at the spot where the hydrogen atom is missing. This forms C_6H_{12} and a more explicit chemical formula for methyl cyclopentane groups is $C_5H_9CH_3$, which shows the methyl group and the cyclopentane ring. Attach instead two

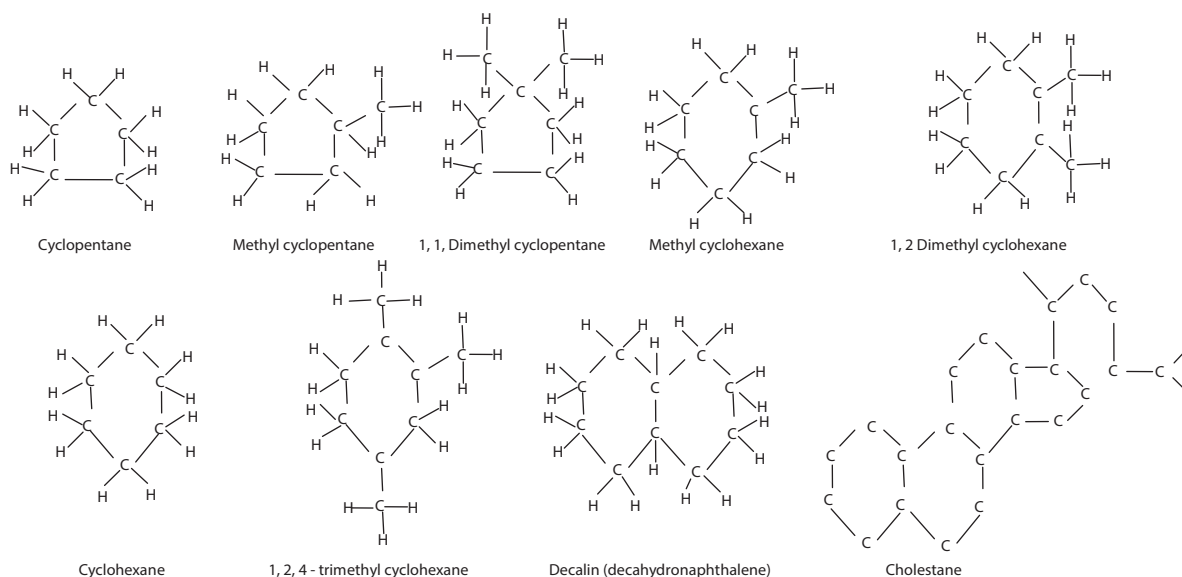


Figure 2.3 Naphthenes.

methyl groups where the hydrogen atoms are missing and there will form dimethyl cyclopentane. Use of an ethyl group, C_2H_5 , will form ethyl cyclopentane. As such there can be hundreds of thousands of compounds in a crude oil. Table 2.3 shows typical physical constants of selected cycloparaffins.

2.2 Aromatic Hydrocarbons

The aromatic series of hydrocarbons is chemically and physically very different from the paraffins and cycloparaffin (naphthenes). Aromatic hydrocarbons contain a structure of at least one ring containing three conjugated double bonds, which account for some remarkable properties. The first three aromatic hydrocarbons: benzene, toluene and xylene (BTX) are the basic raw materials for the petrochemical industry. Benzene, toluene and the xylenes have high-octane numbers, which make them suitable for making gasoline. Also, as with ethylene, the double bonds make the benzene ring very chemically reactive. That makes the BTXs very popular building blocks in the chemical industry. The reactivity lent by the double bonds on the aromatics ring may be best illustrated by the numerous petrochemicals derived from them, namely: polystyrene, epoxy, polyesters such as PET or polyethylene terephthalate, the water bottle minerals. The general formula is C_nH_{2n-6} , ($n = 6, 7, 8$, etc.) where n is the number of carbon atoms. The higher homologs are generally considered a nuisance because they cause environmental

and public health problems and impair catalyst activity by coke deposition.

The basic pattern common to all aromatics is the benzene ring as illustrated by Kekule's formula (Figure 2.4).

The structural formula is often represented by:



The hydrogen atom attached to each carbon atom in the hexagon has been omitted by convention. The hydrogen atoms can be substituted in the following ways:

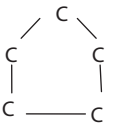
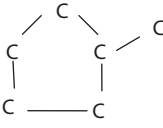
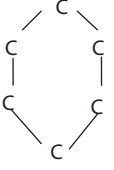
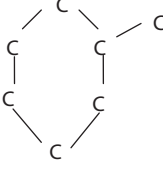
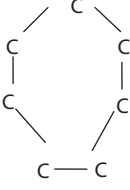
Either by alkyl groups which are designated by the letter R, which is equivalent to C_nH_{2n+1} , to give alkylaromatics, $n = 1$ or 2 as the methyl group, CH_3 or ethyl group, C_2H_5 . If one of the hydrogen atoms of the benzene molecule, C_6H_6 is removed and is replaced by a methyl group, yields a toluene molecule ($C_6H_5CH_3$). Further, if the two methyl groups are substituted for two hydrogen atoms on the benzene ring yields a xylene molecule $C_6H_4(CH_3)_2$. The structural formulas of benzene, toluene and xylene are (Figure 2.5):

The prefixes ortho, meta and para are used to show positions of substitutes on the ring. Therefore, xylene (C_8H_{10}) or dimethyl benzenes are represented as follows (Figure 2.6):

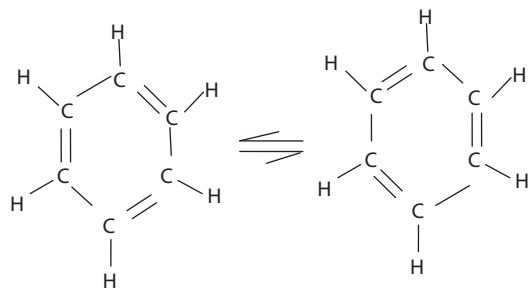
Or by aromatics:

In this instance, a second aromatic ring can be substituted for two adjacent hydrogen atoms giving

Table 2.3 Physical constants of selected cycloparaffins.

Cycloparaffins	Overall formula	Structural formula*	Molecular weight	Boiling point, °C (1 atm)	Specific gravity d_4^{15} (liquid)
Cyclopentane	C_5H_{10}		70.1	49.3	0.750
Methylcyclopentane	C_6H_{12}		84.2	71.8	0.753
Cyclohexane	C_6H_{12}		84.2	80.7	0.783
Methylcyclohexane	C_7H_{14}		98.2	100.9	0.774
Cycloheptane	C_7H_{14}		98.2	118.4	0.811

*Hydrogen atoms are omitted to simplify illustration.

**Figure 2.4** Benzene ring illustrated in Kekule's formula.

condensed polycyclic aromatic hydrocarbons (PAH) as shown in Figure 2.7.

Or by a naphthenic ring that can be substituted for two adjacent hydrogen atoms forming a naphthenes aromatic such as tetralin or tetrahydronaphthalene. These are polycyclic hydrocarbons formed by the fusion of aromatic and alicyclic rings with or without aliphatic side chains. Examples are Indane (C_9H_{10}) and

tetralin ($C_{10}H_{12}$), which are tetra hydro phenanthrene derivatives as shown in Figure 2.8.

The polynuclear aromatic hydrocarbons found in crude oil are mainly the condensed type such as naphthalene, anthracene, phenanthrene, etc. The non-condensed type, biphenyl and triphenyl, are found only very rarely. Polynuclear aromatic hydrocarbons of the ortho-fused type such as benzanthracene, chrysene and that of the ortho and peri fused type like pyrene are also observed in crude oil (Figure 2.9).

Table 2.4 shows typical physical constants of selected aromatic hydrocarbons.

2.3 Heteroatomic Organic Compounds

2.3.1 Non-Hydrocarbons

Crude oils contain significant amounts of organic and non-hydrocarbon constituents, chiefly sulfur,

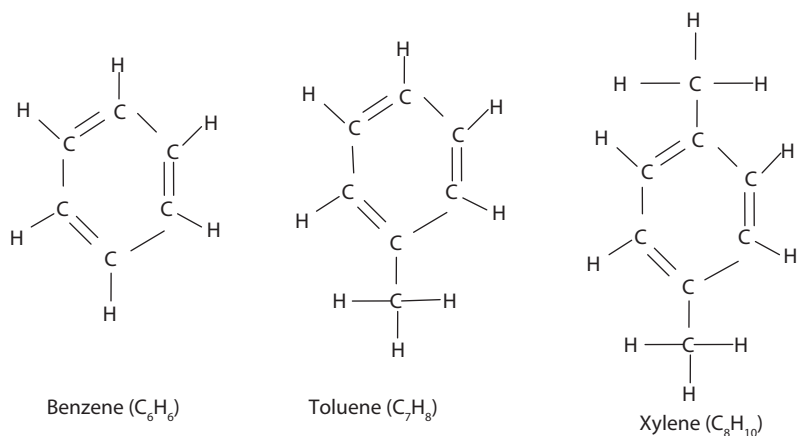


Figure 2.5 Aromatics.

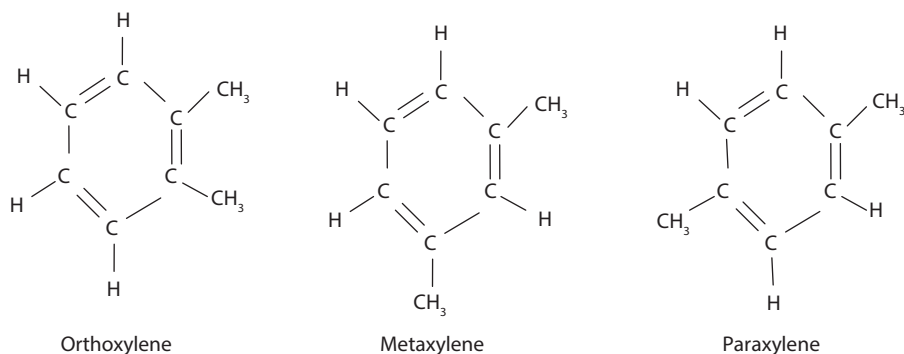


Figure 2.6 Structural formulas of xylene.

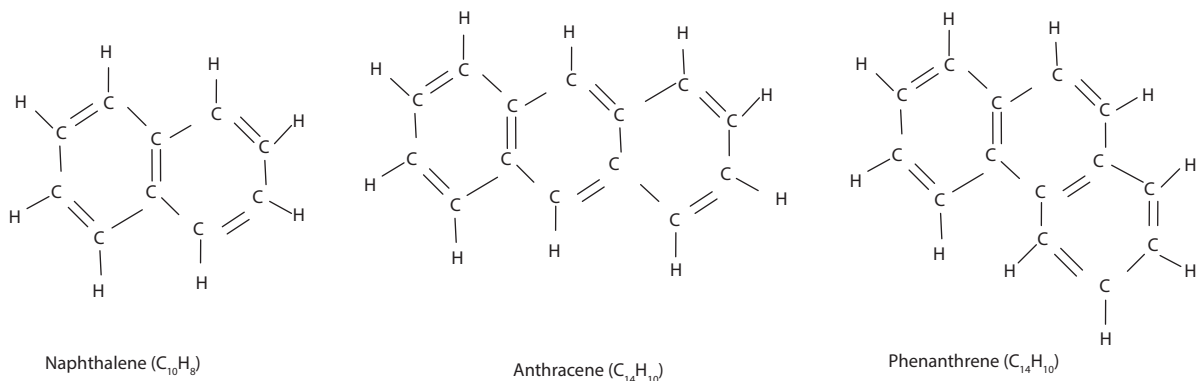


Figure 2.7 Substitution by other aromatics.

nitrogen and oxygen containing compounds and to a smaller extent organometallic compounds in solution and inorganic salts in the form of colloidal suspension. These constituents appear throughout the boiling range of the crude oil and tend to concentrate mainly in the heavier distillation fractions and the non-volatile residue. Although they are present only in very small

amounts, they often bring pronounced effects during the refining of crude oil. For example, the deposition of inorganic salts suspended in the crude can cause serious breakdowns in refinery operations; the thermal decomposition of deposited inorganic chlorides with evolution of free hydrochloric acid can give rise to serious corrosion problems in the distillation equipment.

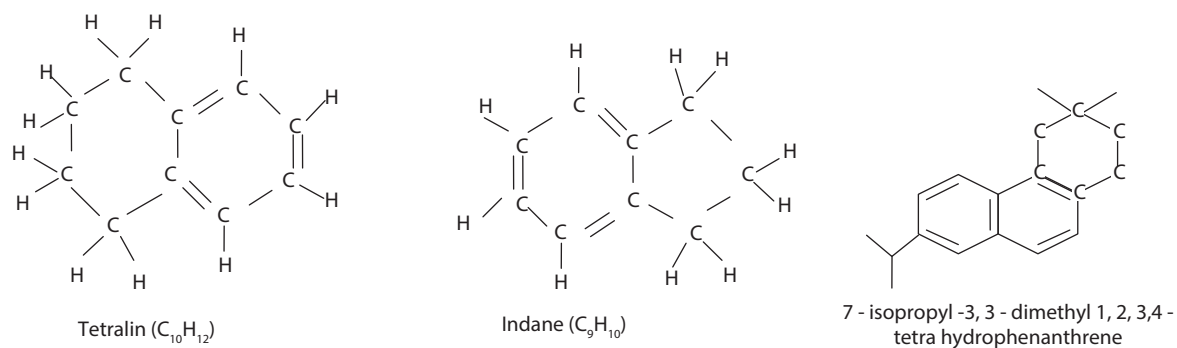


Figure 2.8 Substitution by a naphthenic ring.

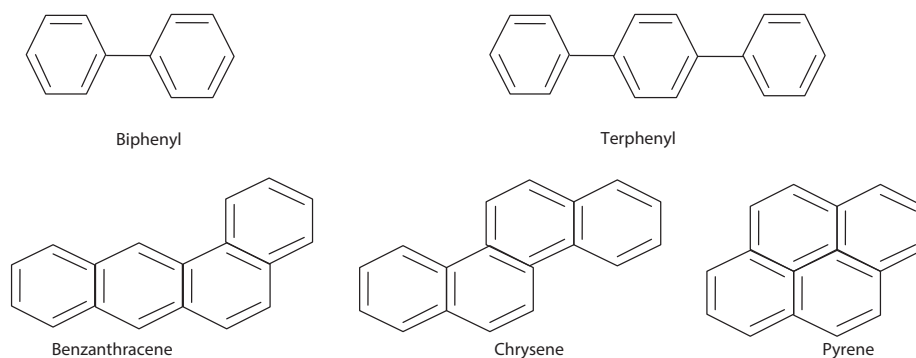


Figure 2.9 Poly nuclear aromatic hydrocarbons.

Table 2.4 Physical constants of selected aromatic hydrocarbons.

Aromatics	Overall formula	Structural formula*	Molecular weight	Boiling point, °C (1 atm)	Specific gravity d_4^{15} (liquid)
Benzene	C ₆ H ₆		78.1	80.1	0.884
Toluene	C ₇ H ₈		92.1	110.6	0.871
Ethylbenzene	C ₈ H ₁₀		106.2	136.2	0.871
o-xylene	C ₈ H ₁₀		106.2	144.4	0.884
m-xylene	C ₈ H ₁₀		106.2	139.1	0.868
p-xylene	C ₈ H ₁₀		106.2	138.4	0.865

*Hydrogen atoms are omitted to simplify illustration.

The presence of organic acidic components, e.g., mercaptans and acids, can also promote metallic corrosion. In catalytic operations, passivation and/or poisoning of the catalyst can be caused by deposition of traces of metals (vanadium, nickel) or by chemisorptions of nitrogen-containing compounds on the catalyst, thus necessitating the frequent regeneration of the catalyst or its expensive replacement. The presence of traces of non-hydrocarbons may impact objectionable characteristics in finished products such as discoloration or lack of stability on storage or reduction in effectiveness of antiknock additives.

Organic acid components such as thiols and carboxylic acids can promote metallic corrosion; reforming catalysts used during the production of motor gasoline are deactivated by sulfur compounds; passivation or poisoning of the catalysts can occur during catalytic cracking process by the deposition of trace metals like vanadium and nickel present in the crude or by the chemisorptions undergone by the deposited nitrogen compounds on the catalyst.

Similarly, the nitrogen and oxygen compounds present in the crudes produce certain nauseating and objectionable characteristics like odor, discoloration and instability in storage of the finished products. The decomposition of inorganic salts suspended in crude can cause a serious breakdown in refinery operations because their decomposition is accompanied by evolution of the free hydrogen chloride, which can result in serious corrosion problems to the distillation equipment.

2.3.2 Sulfur Compounds

Sulfur may be present in crude oil as hydrogen sulfide (H_2S), as compounds (e.g., mercaptans, sulfides, disulfides, thiophenes, etc.) or as elemental sulfur. Each crude oil has different amounts and types of sulfur compounds, but the proportion, stability, and complexity of the compounds are greater in heavier crude-oil fractions. Sulfur compounds comprise the largest group of non-hydrocarbons in crude oils, as these vary considerably in their sulfur content. The sulfur content of crude oils is often in the range 1–4 weight percent, but varies from less than 0.05 weight percent to more than 10 weight percent. The sulfur content is correlated with the gravity of the crude oil and therefore, its quality can be light or heavy. Crude oil with less than 1 weight percent sulfur is referred to as low sulfur or sweet, and that with more than 1 weight percent sulfur is referred to as high sulfur or sour.

Crude oils contain sulfur heteroatoms in the form of elemental sulfur, S, dissolved hydrogen sulfide, H_2S , carbonyl sulfide (COS), inorganic forms, in which sulfur atoms are positioned within the organic hydrocarbon molecules. Sulfur containing constituents of crude oils varies from mercaptans referred to as thiols to sulfides and polycyclic sulfides. Mercaptans are made of an alkyl chain with $-SH$ group at the end ($R-SH$).

Free elemental sulfur (S)

Free sulfur is seldom present in crude oils and whatever is found is usually in suspension or as dissolved in the liquid. Maximum free sulfur (1 weight% out of the total sulfur content of 2.17 weight%) is present in the crude. The free sulfur content formed in the crude is by the reduction of sulfate brought about by the compounds in the reservoir rock.

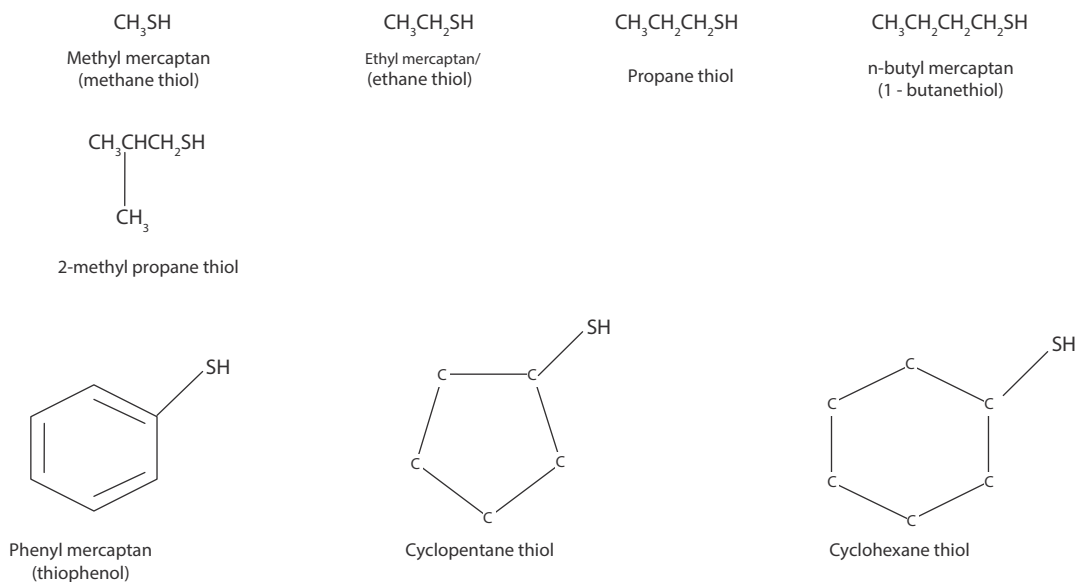
Hydrogen Sulfide (H_2S)

Hydrogen sulfide is found in crude oils in the dissolved state (< 50 ppm by weight). Earlier crude oils were categorized as corrosive (sour) or non-corrosive (sweet) depending upon the amount of dissolved H_2S they contain. If the dissolved H_2S content in the crude is > 6 ppm, then it is referred to as sour crude.

Pyrophoric iron sulfide results from the corrosive action of sulfur compounds on the iron and steel used in refinery process equipment, piping, and tanks. The combustion of petroleum products containing sulfur compounds produces undesirables such as sulfuric acid and sulfur dioxide. Catalytic hydrotreating processes such as hydrodesulfurization remove sulfur compounds from refinery product streams. Sweetening processes either remove the obnoxious sulfur compounds or convert them to odorless disulfides, as in the case of mercaptans. When the total sulfur content of the crude is estimated and that containing more than 1% of total sulfur, then the crude is designated as being corrosive or sour.

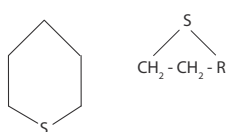
2.4 Thiols

Thiols have the general formula $R-SH$ where $R(C_nH_{2n+1})$, $n = 1, 2$ represents an aliphatic or cyclic radical. Thiols or mercaptans are found in low boiling fractions where the hydrogen bonded to the sulfur has acid characteristics. They are also corrosive and malodorous. Some of the mercaptans found in crude oils are:

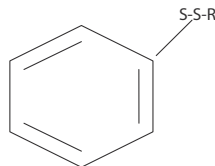


Sulfides

Sulfides are chemically neutral and may possess either a linear or ring structure. In sulfides and disulfides, the sulfur atom replaces one or more carbon atoms in the chain ($\text{R-S-R}'$ or $\text{R-S-S-R}'$). These compounds are present in light fractions, are sometimes referred to as thioethers or monosulfides. Sulfides and disulfides may also be cyclic or aromatic. The presence of these compounds in crude oil causes problems in the refining process as do mercaptans and hydrogen sulfide.



Cyclic sulfides

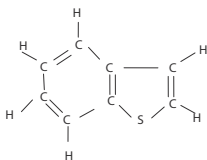


Aromatic sulfides

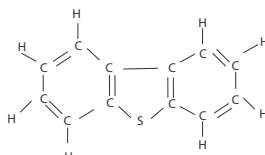
Thiophenes and their derivatives, often present in fractions boiling over 482 °F (250 °C), constitute an important group of sulfur compounds. The sulfur atom is positioned in the aromatic rings.



Thiophene



benzothiophene

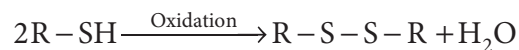


dibenzothiophene

A knowledge of these compounds is important because they often have undesirable attributes, e.g., unpleasant odor, the sulfur dioxide (SO_2), formed by combustion and catalyst poisoning. There are a number of refining processes to eliminate sulfur compounds, and these are reviewed in the text.

Disulfides

They have the general formula RSSR . They are not regarded as true constituents of crude oil but are generally formed by oxidation of thiols during processing.



These compounds are difficult to separate and therefore only few have been identified.

Dimethyl sulfide or $\text{CH}_3 - \text{S} - \text{S} - \text{CH}_3$
2, 3 dithiobutane

Diethyl disulfide or $\text{CH}_3 - \text{CH}_2 - \text{S} - \text{S} - \text{CH}_2 - \text{CH}_3$
2, 3 - dithiohexane

Table 2.5 shows the weight percent of elements in some selected crude oils.

Heavy crudes contain greater sulfur, which require treatment in the refinery and Figure 2.10 shows reactions of hydrocarbons sulfur compounds with hydrogen. We shall review the hydrotreating of these compounds later in the text.

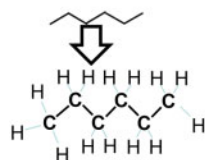
Table 2.5 Physical property and analysis of elements in selected crude oils.

Crude oil	Origin	Visc. mm ² /s	Asph. wt.%	O wt%	N wt%	S wt%	Ni ppm	V ppm
Batiraman	Turkey	1180	22.1	0.53	0.49	7.04	99	153
Boscan	Venezuela	595	14.1	0.79	0.74	5.46	125	1220
Lacq. Sup.	France	81.7	13.2	0.57	0.42	4.94	19	29
Chauvin Source	Canada	28	6.0	0.48	0.66	2.80	35	67
Bellshill Lake	Canada	7.9	2.2	0.34	<0.3	1.97	11	18
Emeraude	Congo	113	1.7	1.10	0.65	0.57	64	9
Anguille	Gabon	14.1	1.2	0.92	0.26	0.82	115	14
Duri	Sumatra	51	0.7	0.65	0.47	<0.10	39	1.5
Pematang	Sumatra	10.2	0.1	0.51	0.26	<0.10	15	0.6
Edjeleh	Algeria	5.3	0.1	0.73	0.34	<0.10	1.5	2.3
Hassi Messaoud	Algeria	2.32	0.1	1.93	0.38	<0.10	<0.2	<0.2

Hydrodesulphurization – removal of sulfur by breaking Carbon to Sulfur (C-S) Bonds and replacing it with C-H and H-S bonds.

Hydrodesulfurization of several sulphur compounds that can be found in various oil fractions.

- R₁, R₂ = Alkyl Group
- Chem'l Structure



What happens to the reactants on the surface of the catalyst?

Adsorbed into the Catalyst Surface
Recombine into Products (New Form)
Desorbed from the Catalyst

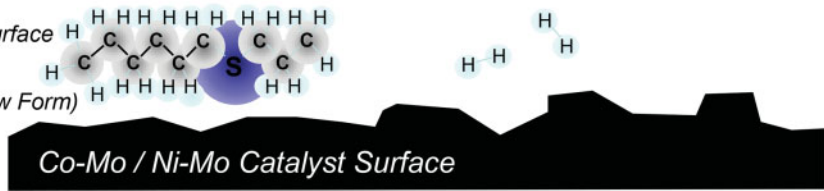
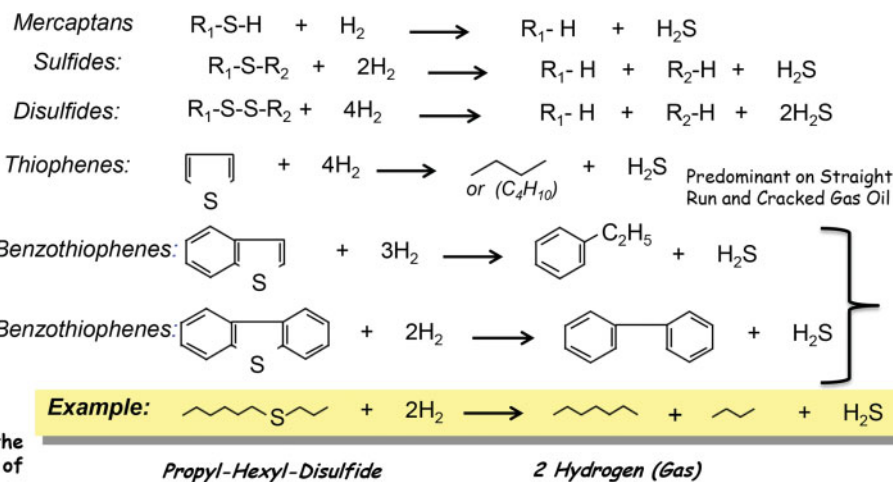


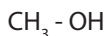
Figure 2.10 Reactions of hydrocarbon sulfur compounds with hydrogen.

2.5 Oxygen Compounds

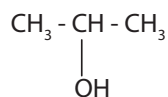
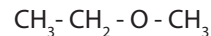
The oxygen content of crude oil is usually less than 2 weight percent. High oxygen content shows that the oil has suffered prolonged exposure in the atmosphere. Oxygen in crude oil occurs in a variety of forms; these include alcohols, ethers, carboxylic acids, phenolic compounds, ketones, esters and anhydrides. The presence of such compounds causes the crude to

be acidic with consequence processing problems as corrosion.

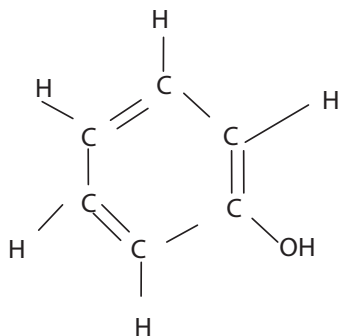
Alcohols have the general formula ROH with one of the hydrogen atoms replaced by an alkyl group. Phenol (C₆H₅OH) where one of the hydrogen atoms in the aromatic ring is replaced with a hydroxyl group (-OH). Ethers have two organic groups connected to a single oxygen atom R-O-R'. Examples of alcohols, phenols and ethers are:



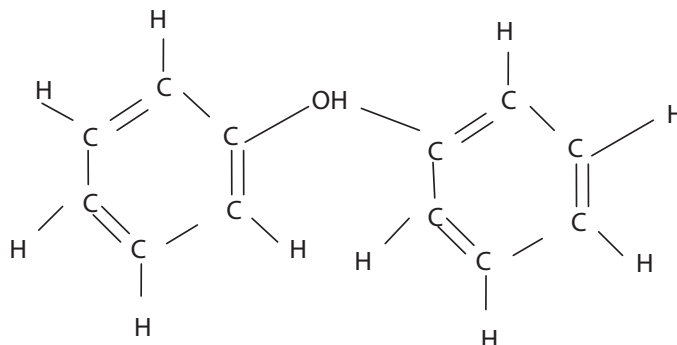
Methyl alcohol

Isopropyl alcohol
(2 - propanol)

Ethyl methyl ether



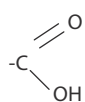
Phenyl alcohol (phenol)



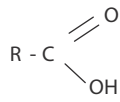
Diphenyl ether

The middle distillates of naphthenic crude contain several acyclic isoprenoids acids. Oxygen when present can be a part of the ring or can take the form of aldehydes, ketones or acids. Oxygen normally is associated with very large molecules. The carboxylic acid group is usually found associated with a naphthenic group than to an aromatic ring. Such organic acids are generally referred to as naphthenic acids.

Carboxylic acids can be represented as $\text{R}-\text{COOH}$, where R is the alkyl radical, an aromatic ring or a saturated ring. In this case, they are naphthenic acids for which the carboxylic group is bonded to either a cyclopentane or cyclohexane molecule. An abundance of acids in certain crude oils, naphthenic acids causes corrosion problems.



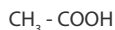
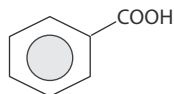
Carboxyl group



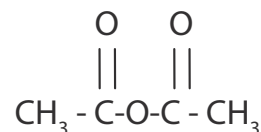
Carboxylic acid

or $\text{R} - \text{COOH}$

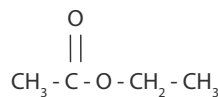
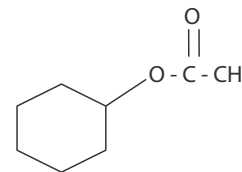
Examples of aliphatic and aromatic acids are:

Acetic acid
(ethanoic acid)Benzoic acid
(benzenecarboxylic acid)

Carboxylic acid anhydrides are formed by removing water from two carboxylic groups and connecting the fragments. The most important anhydride is acetic anhydride

Acetic anhydride
(ethanoic anhydride)

Carboxylic acid esters are formed by replacing the $-\text{COOH}$ by $-\text{COOR}$. E.g.,

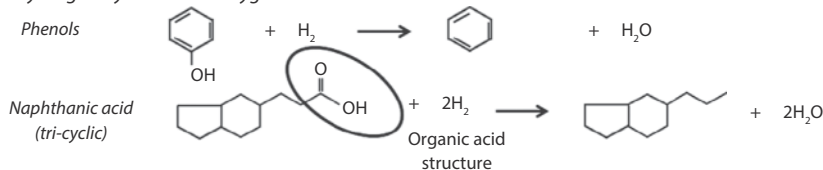
Ethyl acetate
(ethyl ethanoate)

Phenol acetate

Some reactions of O and OH hydrocarbon compounds with hydrogen are illustrated as:

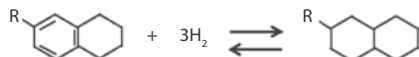
Hydrodeoxygenation – removal of oxygen from oxygen compounds (*oxygenates*) by breaking carbon to oxygen (C-O) bonds.

Hydrogenolysis of some oxygenates:

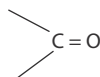


Hydrodeoxygenation of aromatics and poly-aromatic – Saturates the double bonds present in the aromatic structure forming naphthanic compounds.

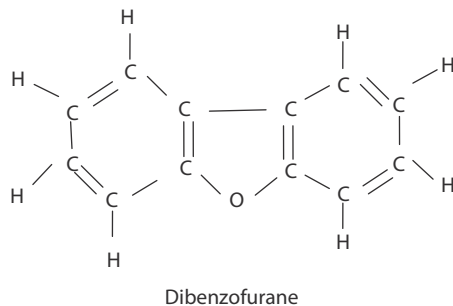
Hydrogenation of naphthalenes:



Ketones are compounds with two carbon atoms bonded to the carbon of a carboxylic group



Furanes and benzofuranes are heteroaromatic compounds in which an oxygenated ring is condensed into one or more aromatic rings.



2.6 Nitrogen Compounds

Crude oils contain very low amounts of nitrogen compounds. They are found mostly in fractions boiling over 482 °F (250 °C) and are particularly concentrated in resins and asphaltenes. The more asphaltic the oil, the higher its nitrogen content. Nitrogen is found in lighter fractions of crude oil as basic compounds, and more often in heavier fractions of crude oil as non-basic compounds that may also include trace metals such as copper, vanadium, and/or nickel.

In general, the nitrogen content of petroleum crudes is low and generally falls within the range 0.1–0.9%, although certain crudes have been reported with

nitrogen content as high as 2.0%. Many crudes have also been reported with no detectable, or trace amounts of nitrogen. Another general approximation is that, the more asphaltic the oil, the higher its nitrogen content.

The nitrogen content of the crude oil can be correlated with the API gravity in a manner similar to that of sulfur (Figure 2.11). It follows that there is an approximate correlation between the nitrogen content and the carbon residue; the higher the carbon residue, the higher is the nitrogen (N₂) content.

Nitrogen compounds in petroleum are harmful during refining operations. They can lead to poisoning of cracking catalysts and they also contribute to gum formation in products such as domestic fuel oil. With the trend of cutting deeper into the crude to obtain heavier stocks for catalytic cracking, the problem of nitrogenous organic compounds during processing has increased.

The basic nitrogen compounds can be removed by extraction with dilute mineral acids. However, the higher molecular weight or non-basic nitrogen compounds are difficult to remove due to unfavorable partition between the oil and aqueous phases.

Nitrogen compounds are more stable than sulfur compounds and therefore, are harder to remove. Although, they are present in low concentration, nitrogen compounds can have great significance in refinery operations as nitrogen oxides can form in process furnaces. The decomposition of nitrogen compounds in catalytic cracking and hydrocracking processes forms ammonia and cyanides that can cause corrosion. This is because of their effects on the catalysts, thus causing their poisoning, and they also contribute to gum formation in the finished products. Nitrogen takes the following forms:

In saturated or aromatic amides:

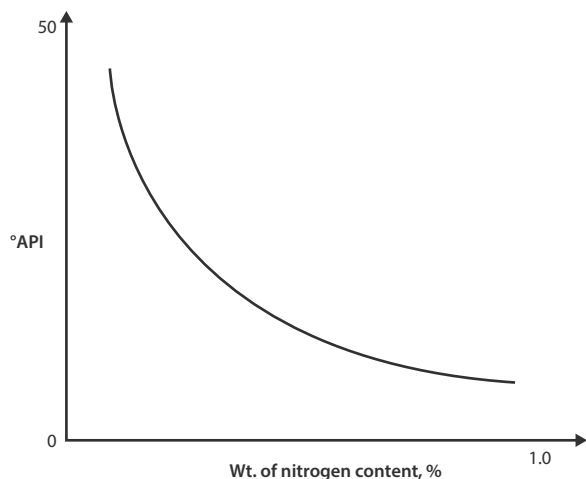
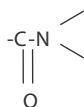
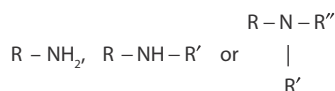


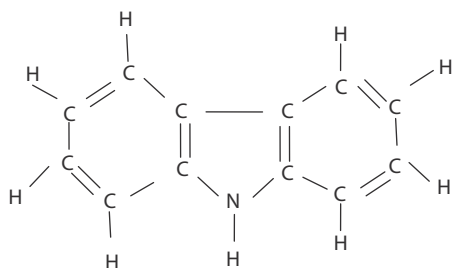
Figure 2.11 Relationship of nitrogen content of crude oils to °API gravity.



As amines:



As carbazoles, where a ring containing nitrogen is condensed with one or more aromatic rings forming neutral compounds. In non-basic nitrogen compounds, the pyrroles are five numbered heteroaromatic compounds containing one nitrogen atom. When fused with benzene ring, pyrrole is converted to the polycyclic heteroaromatic compounds as indole and carbazole. The compound dibenzopyrrole is:

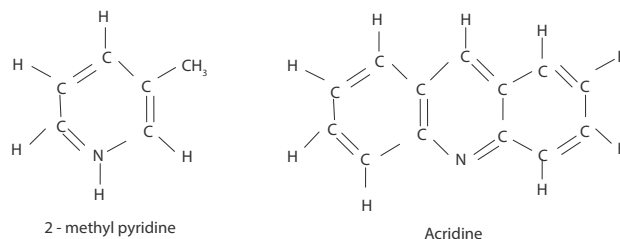


As pyridines with basic nitrogen:

Nitrogen is formed in a hexagonal ring having three double bonds. The compounds in this family are those which can give a basic character to petroleum products and can thus poison acid catalysts. The nitrogen

compounds in crude oils may be classified as basic or non-basic. Basic nitrogen compounds consist of pyridines. The greater part of nitrogen in crude oils is the non-basic nitrogen compounds, which are generally of pyrrole types. Figure 2.12 shows the reactions of hydrocarbon nitrogen compounds with hydrogen.

e.g.,



2.7 Resins and Asphaltenes

The physical properties of crude oils such as the specific gravity (or °API), are greatly influenced by high-boiling constituents in which the heteroatoms (sulfur, nitrogen and metals) concentrate. It is important to characterize the heaviest fractions of crude oils in order to determine their properties and ease of processing. This requires determining the percentage of two generally defined classes of compounds, namely resins and asphaltenes.

Resins are polar molecules with the molecular weight range of 500–1000, which is insoluble in liquid propane but soluble in n-heptane. Resins in the pure state are either heavy viscous liquids or sticky solids and as much volatile as other hydrocarbons of the same molecular size. Resins and asphaltenes both have similar basic structures and are both formed by the oxidation of polycyclic aromatic hydrocarbons. The resin molecules surround the asphaltene clusters (micelles) and suspend them in liquid oil. Because each asphaltene is surrounded by a number of resin molecules, the content of resins in crude oils is higher than that of the asphaltenes.

Asphaltenes are dark-brown friable solids that have no definite melting point and usually leave a carbonaceous residue on heating. They are made up of condensed polynuclear aromatic layers linked by saturated links. Asphaltene molecules contain some 10 to 20 pre-condensed aromatic rings carrying naphthenic and paraffinic groups remaining in the form of aggregates (micelles, molecular weight greater than 30,000; particular molecular weight ~ 3,000 to 10,000) that

Hydrodenitrogenation – removal of nitrogen by breaking carbon to nitrogen (C-N) bonds, needs more hydrogen (higher partial pressure) and higher reaction temperature compared to hydrosulphurization.

Hydrogenolysis of some nitrogen compounds

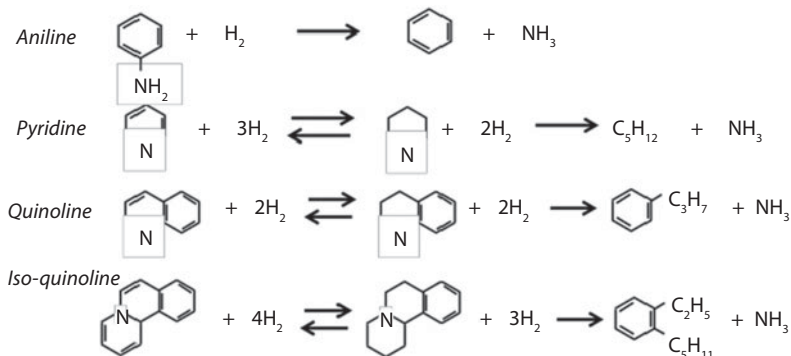


Figure 2.12 Reactions of nitrogen compounds with hydrogen.

are also capable of forming complex with metals like vanadium and nickel. Asphaltenes are separated from petroleum in the laboratory using non-polar solvents such as pentane and n-heptane. Liquefied petroleum fractions (propane and butane) are used commercially in deasphalting residues and lube stock oils.

The presence of high amounts of asphaltenes in crude oil can create problems during production because they tend to precipitate inside the pores of rock formation, well heads and surface processing equipment. Furthermore, problems could arise during transportation because they contribute to gravity and viscosity increases of crude oils. During refining operations, asphaltenes have adverse effects on the processing of the crudes. They lead to coke formation and metal deposition on the catalyst surface causing catalyst deactivation.

2.8 Salts

Crude oils often contain inorganic salts such as sodium chloride (NaCl), magnesium chloride (MgCl_2), and calcium chloride (CaCl_2) in suspension or dissolved in entrained water (brine). These salts must be removed or neutralized before processing to prevent catalyst poisoning, equipment corrosion, and fouling. Salt corrosion is caused by the hydrolysis of some metal chlorides to hydrogen chloride (HCl) and the subsequent formation of hydrochloric acid when crude is heated. Hydrogen chloride may also combine with ammonia to form ammonium chloride (NH_4Cl), which causes fouling and corrosion.

2.9 Carbon Dioxide

Carbon dioxide may result from the decomposition of bicarbonates present in or added to crude, or from steam used in the distillation process.

2.10 Metallic Compounds

Metallic compounds are found in all crudes, and the presence of numerous other trace metals have been detected, as their concentrations vary from <1–1300 ppm depending on the source. The presence of these metals such as iron (Fe), copper (Cu), nickel (Ni) and vanadium (V) poses operational problems during refining of the crudes. Metals affect many upgrading processes that can poison the catalysts used for hydroprocessing and cracking. Small amounts of metals (e.g., Fe, Ni, V) in the feedstock to the catalytic cracking unit affect the activity of the catalyst, which results in increased gas and coke formation with reduced gasoline yields. In high-temperature power generators, such as oil-fired gas turbines, the presence of vanadium in the fuel can result in ash deposits on turbine rotors, thereby reducing clearances and disturbing their balance. In furnaces/fired heaters, the ash that results from the combustion of fuels containing sodium and especially vanadium that reacts with refractory linings to lower their fusion points and subsequent deterioration.

The ash obtained as a residue when a crude oil sample is burned is mainly due to these metallic constituents, a part of which remains as inorganic water soluble salts

(chiefly chlorides and sulfates of sodium, potassium, magnesium and calcium) in the water phase of crude oil emulsions. Other metals remain in the form of oil soluble organometallic compounds. Zinc, titanium, calcium and magnesium are found in the form of organometallic soaps having surface active properties adsorbed in the water/oil interfaces and act as emulsion stabilizers. Vanadium, copper and nickel and a part of the iron present in crude oil remain a separate category of oil soluble compounds. These metals are able to complex with the pyrrole pigment compounds obtained from chlorophyll and hemoglobin present in plant and animal source materials. Table 2.6 shows the complete list of metal elements and their approximate range in petroleum.

Crude distillation concentrates the metallic constituents in the residues though some can appear in the higher boiling distillates partly due to entrainment and partly due to volatilization of the organometallic compounds in the crude. When treating residual stocks, it is essential to precipitate the majority of vanadium, nickel, iron and copper along with the asphaltenes by hydrocarbon solvents. The removal of asphaltenes with n-pentane reduces the vanadium content of the oil up

to 95% with substantial reductions in the amounts of iron and nickel.

2.11 Products Composition

Refineries worldwide produce various marketable specifications of their products and intermediate feedstocks can be routed to various units in the facilities to produce different blends products depending again on market demands. Crude oil is processed or refined to produce useable products such as gasoline. The process can be very complex and involves both chemical reactions and physical separations. Crude oil is composed of thousands of different molecules. It would be nearly impossible to isolate every molecule and make finished products from each molecule. Chemists and engineers resolve this problem by isolating mixtures of molecules according to the mixture's boiling point range. For example, gasoline molecules might boil in the range from 90 to 400 °F (32–204 °C). Home heating oil could be from molecular mixes that boil from 500 to 650 °F (260–343 °C). The main products are described as follows:

Table 2.6 Trace elements in petroleum crude oils.

Element	Range in petroleum, ppm
Aluminum (Al)	0.5–1.0
Barium (Ba)	0.001–0.1
Boron (B)	0.001–0.1
Calcium (Ca)	1.0–2.5
Cerium (Ce)	0.001–0.6
Cobalt (Co)	0.001–12.0
Copper (Cu)	0.2–12.0
Gallium (Ga)	0.001–0.1
Iron (Fe)	0.04–120
Lead (Pb)	0.001–0.2
Magnesium (Mg)	1.0–2.5
Mercury (Hg)	0.03–0.1
Nickel (Ni)	3.0–120.0
Silicon (Si)	0.1–5.0
Strontium (Sr)	0.001–0.1
Tin (Sn)	0.1–0.3
Titanium (Ta)	0.001–0.4
Vanadium (V)	5.0–1500
Zinc (Zn)	0.5–1.0
Zirconium (Zr)	0.001–0.4

Fraction	Boiling range
Butanes and lighter	< 90 °F (32 °C)
Light straight run gasoline (LSR) or light naphtha	90–190 °F (32–88 °C)
Naphtha or heavy naphtha (HN)	190–380 °F (88–193 °C)
Kerosene	380–520 °F (193–271 °C)
Distillate or atmospheric gas oil (AGO)	520–650 °F (271–343 °C)
Residua	650 °F+ (343 °C +)
Vacuum gas oil (VGO)	650–1000 °F (343–538 °C)
Vacuum residua	1000 °F + (538 °C+)

Refined products are produced by combining fractions from the raw crude oil with those from various refinery processing units. These fractions are mixed or blended to satisfy specific properties that are important in allowing the refined product to perform as desired in an engine, for ease in handling and to reduce the undesirable emissions produced when the product is burned. For convenience, the mixtures or fractions are given a name. The following chart illustrates the boiling range and name of the petroleum fraction. Figure 2.13 illustrates typical refinery products with their carbon atom contents and boiling ranges.

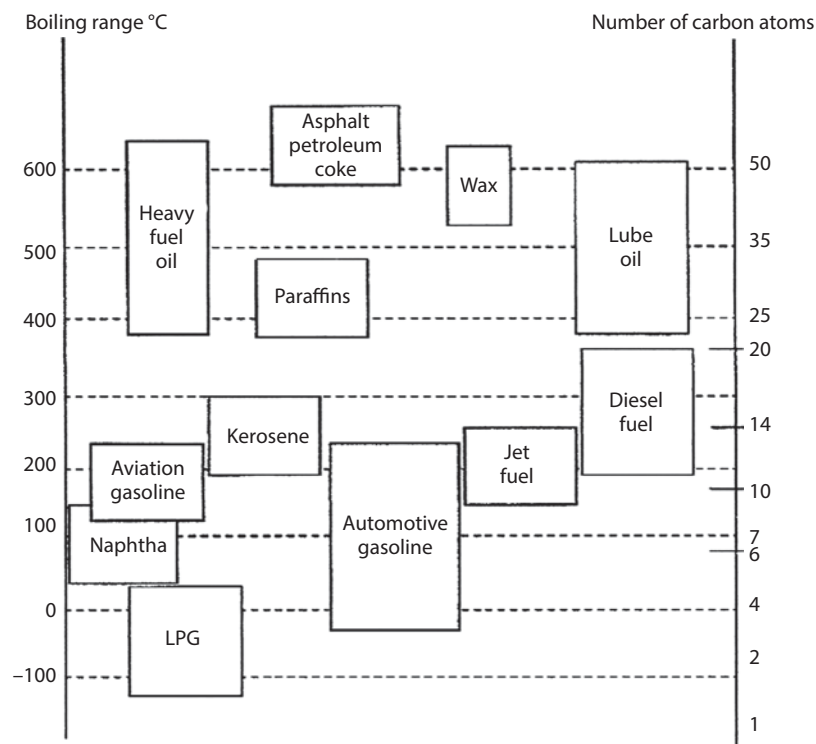


Figure 2.13 Principal petroleum products with carbon numbers and boiling ranges.

2.11.1 Liquefied Petroleum Gas (LPG) (C_3 and C_4)

Liquefied Petroleum Gas (LPG): The condensable/liquefied gases of propane (C_3) and butane (C_4) fraction of gaseous hydrocarbons from crude oil refining or natural-gas fractionation. They include ethane, ethylene, propane, propylene, normal butane, isobutane, isobutylene and butylene. These hydrocarbons have the advantage that they can be stored and transported as liquid of high thermal density and at the same time be used as a gas. For ease of transportation, these gases are liquefied through pressurization and then vaporized for use as a heating fuel, engine fuel or as a feedstock in the petrochemical or chemical industries. Pressure vessel tanks are used to keep it in the liquid state, as it is kept under pressure. This pressure has to be maintained during all activities from storage at the refinery, during transportation by road/rail tank wagon and up to the delivery point.

It has a flammability range of 1.8%–10%, and the vapor has a density of 1.5–2.0 that of air. One volume of LPG liquid may form 2,300–13,500 times the volume of gas in air. LPG vapor is anesthetic and asphyxiant in high concentrations. It's odorless, colorless,

non-corrosive and non-toxic. It has a low viscosity and therefore, is more likely to find a leakage path than other petroleum products. In case of a leakage, it tends to spread on the surface accompanied by a visible fog of condensed water vapor. However, the ignitable vapor mixture extends beyond the visible area.

2.11.2 Gasoline (C_5 to C_{11})

Gasoline is a mixture of the lighter liquid hydrocarbons that distills within the range of 100 - 400 °F (38 - 204 °C). Commercial gasolines are a mixture of straight-run, cracked, reformed and natural gasoline. It is produced by the fractional distillation of petroleum by condensation or adsorption from natural gas; by thermal or catalytic decomposition of petroleum or its fractions; by the hydrogenation of producer gas or by the polymerization of hydrocarbons of lower molecular weight.

Gasoline produced by the direct distillation of crude petroleum is referred to as straight-run gasoline. It is usually distilled continuously in a bubble tower, which separates the gasoline from the other fractions of the oil having higher boiling points, such as kerosene, fuel oil, lubricating oil and grease. The range of temperature

in which gasoline boils and is distilled off is roughly between 100 - 400 °F (38 - 205 °C). The yield of gasoline from this process varies from about 1 - ~ 50% depending on the crude. Straight-run gasoline makes up only a small part of gasoline production because of the superior merits of the various cracking processes. The flash point of gasoline is well below 0 °F (-17.8 °C), and at atmospheric, burning smoke production normally occurs.

Gasoline can be classified by octane ratings (commercial, oxygenated and reformulated) into three grades, namely: regular, midgrade and premium.

Regular gasoline: Having an antiknock index, i.e., octane rating greater than or equal to 85 and less than 88.

Midgrade gasoline: Having octane rating equal to or greater than 88 and less than or equal to 90.

Premium gasoline: Having octane rating greater than 90.

Premium and regular grade motor gasoline are used depending on the octane rating. Additionally, aviation gasoline, which is a complex mixture of relatively volatile hydrocarbons, is blended with additives as a fuel for aviation engines.

Gasoline octane number: It is the number that it is referred to when selecting the grade of gasoline to use on a vehicle. The number may be 87 or 89. The vehicle manufacturer recommends a certain type of fuel to be used. In most vehicles, it is 87 octane unleaded gasoline. This octane rating is actually the average of two tests that are run on the finished gasoline, the Research Octane (R) and the Motor Octane (M). The average is the Road Octane or $(R+M)/2$ which is posted on the pumps at filling stations. The difference between Research and Motor Octane is around eight with Research being higher.

Gasoline is blended to meet the following specifications:

Reid Vapor Pressure(RVP)	Measures the amount of hydrocarbon vapors needed for starting engines.
Octane number	Measures antiknock level of gasoline and is important because knocking lowers engine efficiency and wastes power.
Toxics	Measure the harmful components in gasoline and refiners are required to lower benzene, olefins and sulfur levels.

Oxygen content	Reformulated gasoline to reduce the level of green house gas emissions.
Freeze Point	The temperature at which the fuel forms ice crystals which could clog engine fuel filters.
Viscosity	Measures how easily the jet fuel flows. Diesel engines are different than gasoline engines, and as a result have different specifications.
Cetane Index	Measures engine performance.
Sulfur content	Determines the level of sulfur oxides in the exhaust.
Pour Point	Is the temperature at which the diesel fuel flows.

2.11.3 Condensate (C_4 , C_5 , and C_6 >)

The condensate is normally considered the entrapped liquid from the process or production gas streams due to temperature or pressure. It is typically in the range of C_3 , C_4 , C_5 and heavier hydrocarbon liquids. It is also known as natural gasoline pentanes plus (C_5 plus) and as a liquid at normal temperature and pressure. It is normally condensed (i.e., by expansion and cooling of the gas) out of the process stream in primary separation processes, where it is then sent to other refinery processes to further separate the condensate into its primary fractions, i.e., propane, butane, and liquid constituents.

The flash point of the condensate is generally taken as that of hexane (C_6) as hexane has the lowest flash point of any material in the condensate.

2.11.4 Gas Fuel Oils (C_{12} to C_{19})

Gas oil or fuel oil is a term applied to petroleum distillates boiling between kerosene and lubricating oils. The name gas oil was originally derived from its initial use for making illuminating gas, but is now used as a burner fuel, diesel engine fuel, and catalytic cracker charge stock. Gas oils contain fuel oils such as kerosene, diesel fuel, gas-turbine fuels, etc.

2.11.5 Kerosene

Kerosene, sometimes referred to as Fuel oil # 1, is a refined petroleum distillate. Kerosenes usually have flash points within the range of 100 °F–130 °F

(37.8 °C–54.4 °C). Therefore, unless heated, kerosene will usually not produce ignitable mixtures over its surface. Kerosene has a maximum distillation temperature of 400 °F (204 °C) at the 10% recovery point, a final boiling point of 572 °F (300 °C). The two grades are recognized by ASTM Specification D3699. A kerosene-type jet fuel-based product has a maximum distillation temperature of 400 °F (204 °C) at the 10% recovery point and a final maximum boiling point of 572 °F (300 °C) and meeting ASTM Specifications D1655.

2.11.6 Diesel Fuel

Diesel or sometimes referred to as Fuel Oil # 2 is the fraction of petroleum that distills after kerosene, which is the family of gas oils. Several grades of diesel are products depending on the intended service. The combustion characteristics of diesel fuels are expressed in terms of a cetane number (CN) or cetane index (CI). The number is expressed in terms of the volume percent of cetane ($C_{16}H_{34}$), which has high ignition (CN=100) in a mixture with alpha-methyl-naphthalene ($C_{11}H_{10}$) which has low ignition quality (CN= 0). Diesel fuel includes No. 1 diesel (Super – diesel), which has cetane number of 45, and it is used in high-speed engines, trucks and buses. No. 2 diesel has cetane number of 40. Railroad diesel fuels are similar to the heavier automotive diesel fuels, but have higher boiling ranges up to 750 °F (400 °C) and lower cetane number (CN = 30).

2.11.7 Fuel Oils # 4, 5, and 6

These are fuels for low- and medium-speed engines or as a feedstock for catalytic cracking in the refinery process. Fuel oils are mainly used in spaced heating and thus the market is high especially in cold climate. No. 1 fuel oil is similar to kerosene and No. 2 fuel oil is very similar to No. 2 diesel fuel.

2.11.8 Residual Fuel Oil

It is mainly composed of vacuum residue. Critical specifications are viscosity and sulfur content. Low sulfur residues are in more demand in the market.

Lubricating Oils and Greases (C_{20} to C_{27})

Vacuum distillates or residual fractions of vacuum distillation are the main source of lubricating oils from

the petroleum industry. Although they account for only 1% of the volume of petroleum fuel sales, they possess a high-value unit. They are employed as heat transfer mediums, as hydraulic fluids, corrosion protection both in industry and society.

Grease is a thick, oily, lubricating material that typically has a smooth, spongy or buttery feel. Lubricating greases are made by thickening lubricating oils, with soaps, clays, silica gel or other thickening agents. Greases range from soft semi-fluids to hard solids, the hardness increases as the content of the thickening agent increases. Greases are classified according to the type of thickener used, e.g., lithium, calcium, organic and their consistency.

Petrolatum is produced from lubricating oils. It is used in the medicinal field where it is combined with other compounds to form creams, ointments and petroleum jelly.

Asphalts and Waxes (C_{28} & >)

Asphalt is a bituminous substance that is found in natural deposits or as the residual of petroleum or coal tar refining processes. It has a black or brownish-black color and pitchy cluster. It is cement-like in nature, varying in consistency at room temperature from solid to semi-solid depending on the amount of light hydrocarbon fractions that have been removed. It can be poured when heated to the temperature of boiling water. The quality of asphalt is affected by the nature of the crude oil and the refining process. It is used in surfacing roads, in water retaining structures, such as reservoirs and swimming pools and in roofing materials and floor tiles. Asphalt is different from tar, which is a black fluid substance derived from coal.

Wax

Wax is a soft impressionable semi-solid material having a dull luster and a somewhat soapy or greasy texture. It softens gradually upon heating, going through a soft, malleable state before ultimately forming a liquid. Paraffin wax is a mixture of saturated hydrocarbons of higher molecular mass, produced during the refining of petroleum. Natural petroleum waxes may occur during the production of some hydrocarbon reservoirs containing heavy oils. Most commercial waxes are produced from petroleum; chlorinated paraffins waxes come into considerable use because of their fire resistant properties.

Petroleum Coke

Carbon compounds formed from thermal conversion of petroleum containing resins and asphaltenes are referred to as petroleum cokes. Fuel grade coke contains about 85% carbon, and 4% hydrogen. The remaining contains sulfur, nitrogen, oxygen, vanadium and nickel.

2.11.9 Natural Gas

Natural gas is a mixture of hydrocarbon and non-hydrocarbon gases found in porous formations below the earth's surface, usually with crude oil. The main component of natural gases is methane (CH_4) together with small amounts of heavier hydrocarbons and some non-hydrocarbon gases such as carbon dioxide (CO_2), helium (He), hydrogen sulfide (H_2S) and nitrogen (N_2). It can further be classified as:

Associated gas: the gas occurs in the free state; however it is in contact with a large amount of crude oil in the reservoir. Associated gas usually contains less methane than non-associated gas, but is richer in higher molecular weight hydrocarbons.

Non-associated gas: the gas remains in the free state, associated with minimal amounts of crude oil. It is richer in methane and leaner in other higher molecular weight hydrocarbons and associated gas.

Dissolved gas: The pressure in the oil reservoir is high, so the gas remains in solution. It is released as a result of drilling.

Natural gas can be in other ways classified as: dry or lean gas which contains mostly methane (CH_4); wet gas which contains considerable quantities of hydrocarbons; sour gas which contains much H_2S ; sweet gas which contains little amount of H_2S ; residue gas from which higher paraffins have been extracted, and finally casing head gas which is derived from an oil well by extraction at the surface.

The non-hydrocarbon components of natural gas can be classified as:

- Diluents such as N_2 , CO_2 and water vapor.
- Contaminants such as H_2S and other sulfur compounds.

The diluents, being non-combustible, reduce the heating value of the gas as fuel and thus can be used as fillers to reduce the heat content. The contaminants

can cause harmful effects and can also affect transportation and production equipment plants.

Natural Gas Liquids (NGL): Liquid hydrocarbon mixtures extracted from natural gas. They fractionate into ethane (C_2H_6), propane (C_3H_8) and butane (C_4H_{10}). Liquefied petroleum gas (LPG) containing C_3H_8 and C_4H_{10} , is the main commercial product made from natural gas and it can be stored and handled as a liquid at ambient temperatures and moderate pressures.

Natural gasoline is a mixture of hydrocarbons extracted from natural gas containing pentanes (C_5H_{12}) and some heavier hydrocarbons. Initially, liquefied petroleum gas and natural gasoline were used solely as fuels, but recently liquefied petroleum gas has been used as a source of propane (C_3H_8) and butane (C_4H_{10}) for the petrochemical industry. Natural gasoline is also used as a source of butanes (C_4H_{10}), isobutanes (iC_4H_{10}), pentanes (C_5H_{12}) and isopentanes (iC_5H_{12}) required for reforming, alkylation, synthetic rubber manufacture, etc.

Table 2.7 shows the general composition of natural gas.

Table 2.7 Composition of natural gas.*

Component	Dry gas (mol%)	Sour gas (mol%)	Gas condensate (mol%)
CO_2	-	6.7	0.7
H_2S	-	3.3	-
N_2 and air	0.8	-	-
CH_4	95.8	84.0	74.5
C_2H_6	2.9	3.6	8.3
C_3H_8	0.4	1.0	4.7
iC_4H_{10}	0.1	0.3	0.9
nC_4H_{10}	Trace	0.4	1.9
iC_5H_{12}	-	-	0.8
nC_5H_{12}	-	-	0.6
C_6H_{14}	-	0.7	1.3
C_7H_{16}	-	-	6.3

* Sometimes natural gas contains some helium content 0–0.5 mol%.

(Source: Majorana, S., K. B., *Modern Petroleum Chemistry*, Kannatheri Publications, 2003).

References

1. Roussel, J., and R. Boulet, "Characterization of Crude Oils and Petroleum Fractions", Chapter 3, In "Crude Oil Petroleum Products Process Flowsheets", *Petroleum Refining*, Vol. 1, Wauquier, J. ed., TECHNIP, France, 1995a.
2. Roussel, J., and R. Boulet, "Composition of Crude Oils and Petroleum Products", Chapter 1, In "Crude Oil Petroleum Products Process Flowsheets", *Petroleum Refining*, Vol. 1, Wauquier, J. ed., TECHNIP, France, 1995b.
3. Roussel, J., and R. Boulet, "Fractionation and Elemental Analysis of Crude Oil and Petroleum Fractions", Chapter 2, In "Crude Oil Petroleum Products Process Flowsheets", *Petroleum Refining*, Vol. 1, Wauquier, J. ed., TECHNIP, France, 1995b.
4. Gary, James, H., Handwerk, Glenn, E., and Mark, J. Kaiser, *Petroleum Refining – Technology and Economics*, 5th ed., CRC Press, 2007.

3

Characterization of Petroleum and Petroleum Fractions

3.1 Introduction

The demand for crude oil is often market-driven, as recently observed in the world economic recession, in which the price of U.S. crude oil fell from U.S. \$140 to \$36/barrel by the end of 2008; and this was repeated between 2014 and 2016. Crude oil distillation is a large energy consumer and a large waste generator, so refiners need to balance the economics of processing crude oil to viable fractions. The thermodynamics of multicomponent distillation apply to petroleum, synthetic crude oil and other complex mixtures. Various advanced integrated and distributed distillation methods can be employed to minimize waste and thus optimize performance of oil [1]. The processing of crude oil requires special consideration for the following reasons:

The feedstocks are generally complex mixtures of different types of hydrocarbons along with inorganic

and organic compounds. The number of carbon atoms in the component molecules ranges from 1 to more than 50, so that the compounds may show atmospheric pressure boiling points from -260°F (-162°C) to more than 1000°F (538°C). Further, the number of different compounds of similar volatility increases very rapidly with corresponding increase in boiling point, e.g., 16 of the 18 octane isomers boil within a range of only 22°F .

The fractionation products of these complex mixtures are often complex themselves, and their character and yields vary widely, and often depend upon the source of the feedstock. Crude oils from the same locality sometimes exhibit marked variations.

The primary raw material for all of the petroleum processes is crude oil, a naturally occurring liquid produced from wells drilled into the earth. The well depth and techniques used to produce the oil vary widely around the world, as does the nature and chemical composition of crude oil itself. The elementary

composition of crude oil will, however, fall within the following ranges

Element	% by weight
Carbon	84–87
Hydrogen	11–14
Sulfur	0.06–8
Nitrogen	0.02–1.7
Oxygen	0.68–1.82
Metals	0–0.14

Crude oil is classified according to the family of hydrocarbons it contains as paraffin base, naphthene base, aromatic base or asphalt base. The refining process is dependent on the crude oil base. The relative values of crude oil depend on the processing costs and the market values of the associated products.

3.1.1 Crude Oil Properties

Crude oil is a mixture of thousands of hydrocarbons; the American Petroleum Institute (API) Project 6 has isolated over 16,000 distinct hydrocarbon compounds from a single sample. The tests outlined in the following sections are employed to characterize crude oils as potential refinery feeds.

3.1.2 Gravity, API

The density of petroleum oil is expressed in the United States as American Petroleum Institute (API) gravity, where API gravity is related to specific gravity as follows:

$$\text{Degrees API} = (141.5/\text{Sp.Gr}) - 131.5 \quad (3.1)$$

Both specific gravity and API gravity are expressed relative to the density of water at 60 °F (15.9 °C). The expression for API is non-linear, and so specific gravities must be used when calculating the gravity for blends. The API gravity is inversely related to the specific gravity, so a higher value shows a less dense material (e.g., The API of water is 10.0). API gravity is preferred to specific gravity as a measure of density because the specific gravities of various crude oils lie very close to each other and the API gravity alone can differentiate between them. API gravity is determined with a hydrometer and corrected to 60 °F (15.9 °C).

Crude oils are also defined in terms of API gravity. The higher the API gravity, the lighter the crude. For example, light crude oils have high API gravities and low specific gravities. Crude oils with low carbon, high hydrogen, and high API gravity are usually rich in paraffins and tend to produce greater proportions of gasoline and light petroleum products; those with high carbon, low hydrogen, and low API gravities are usually rich in aromatics. Figure 3.1 shows plots of °API, pounds per cu. ft., pounds per U.S. gal corresponding to specific gravity, and Table 3.1 shows a typical approximate characteristics, properties and gasoline potentials of various crudes.

In the case of a mixture or blend of various fractions, the API gravity is determined as the sum of the individual API gravity multiplied by the corresponding weight fraction in the mixture.

$$(\text{API})_{\text{mix}} = (\text{API})_1 W_1 + (\text{API})_2 W_2 + (\text{API})_3 W_3 + \dots \quad (3.2)$$

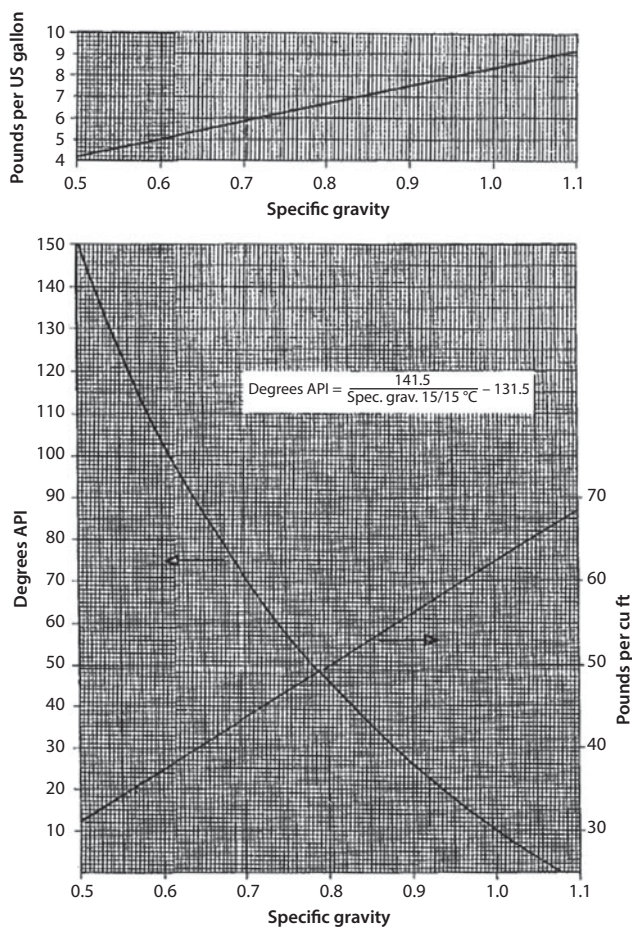


Figure 3.1 Plots of °API, Pounds per cu ft. and Pounds per U.S. gal vs. specific gravity (Source: API Technical Data Book).

Table 3.1 Typical characteristics, properties and gasoline potential of crudes.

Crude source	Paraffinic (% vol.)	Aromatics (% vol.)	Naphthenes (% vol.)	Sulfur (% wt.)	API gravity (approx)	Naphtha yield (% vol.)	Octane number
Nigerian Light	37	9	54	0.2	36	28	60
Saudi Light	63	19	18	2	34	22	40
Saudi Heavy	60	15	25	2.1	28	23	35
Venezuela Light	52	14	34	1.5	24	18	50
Venezuela Heavy	35	12	53	2.3	30	2	60
USA Midcont. sweet	-	-	-	0.4	40	-	-
USA West Texas Sour	46	22	32	1.9	32	33	55
North Sea Brent	50	16	34	0.4	37	31	50

where

API_1, API_2, API_3 , = the respective API for different components.

W_1, W_2, W_3 , = the respective weight fractions.

The specific gravity of crudes can be categorized into four [2]:

Light crude oil, Sp. Gr: (d_4^{15})*	<0.825
Medium crude oil, Sp. Gr: (d_4^{15})	<0.875
Heavy crude oil, Sp. Gr: (d_4^{15})	<1.000
Extra heavy crude oil, Sp. Gr: (d_4^{15})	>1.000

* (d_4^{15}) represents density at 15 °C with respect to that of water at 4 °C.

Table 3.2 shows typical specific gravities of some crudes.

3.1.3 Boiling Point Range

The boiling point range for a crude oil is determined with a *true boiling point* (TBP) distillation test. This test is performed in an apparatus with sufficient fractionation to recover samples of the various products that can be distilled from crude oil. Results are reported at one atmosphere. It is impossible to determine the complete boiling point range for most crude oils, as they thermally degrade above temperatures around 650 °F (344 °C) and a pressure of one atmosphere. Therefore, the pressure is gradually reduced during a TBP distillation test to approximately 40 mm Hg for the heaviest fraction. These conditions are equivalent to a temperature at atmospheric pressure of 900–950 °F (483–510 °C). Nelson and others [3] state that the maximum boiling point for crude oil mixtures is greater than 1400 °F (760 °C).

Table 3.2 Specific gravities of some crude oils.

Country	Crude	Specific gravity (d_4^{15})*
Nigeria	Bonny Light	0.837
Iraq	Kirkuk	0.845
Indonesia	Minas	0.845
Saudi Arabia	Arabian Light	0.858
Kuwait	Kuwait	0.870
Iran	Cyrus	0.940
Venezuela	Boscan	1.000

* d_4^{15} represents density at 15 °C with respect to that of water at 4 °C.

3.1.4 Characterization Factor

Watson Factor (K_w)

Watson, Nelson and Murphy [4] proposed the following characterization factor:

$$K = T_B^{0.333} / \text{Sp.Gr} \quad (3.3)$$

$$T_B = \frac{(\text{Molal average BPt. in } ^\circ\text{R}) (\text{Volume average BPt. in } ^\circ\text{R})}{2}$$

where

K = characterization factor.

T_B = the mean average boiling point of the sample, °R

Sp. Gr. = specific gravity at 60 °F relative to water.

This characterization factor, which is a rough indicator of the hydrocarbon class (or composition) is related to molecular weight, viscosity, critical temperature, etc. $K \leq 10$ indicates an aromatic material whereas $K = 15$ indicates a paraffinic material. For most crude oils, $10.5 < K < 12.5$. Figure 3.2 is a nomograph for

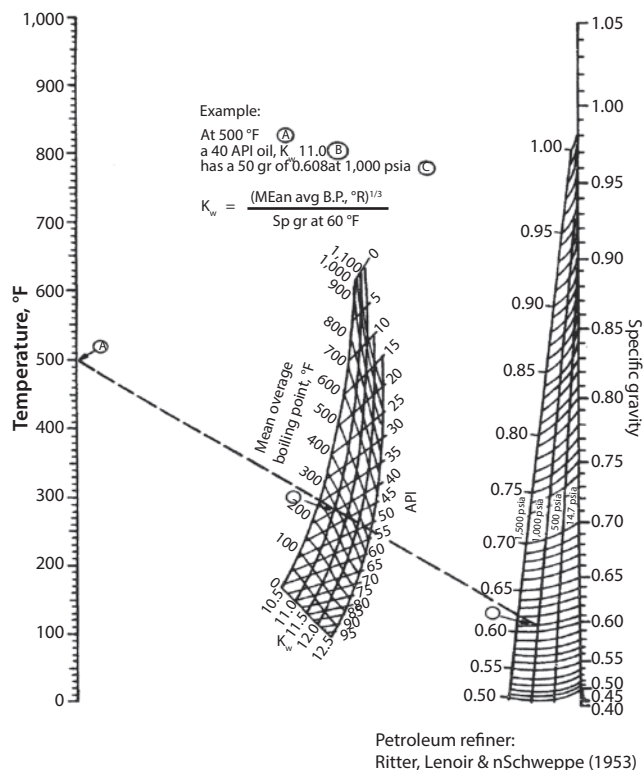


Figure 3.2 Specific Gravity of Petroleum Fractions. Used by permission, *Gas Processors Suppliers Association Book Data*, 12th ed., v.1 and 2 (2004).

estimating the K value from the mean average boiling point, the API gravity and an ASTM D-86 distillation of the petroleum fraction. The characterization factor, K_w is defined in the example given on the figure.

3.1.5 The Universal Oil Product Characterization factor, K_{UOP}

K_{UOP} is widely used since it expresses quantitatively the variations in physical properties that vary with the character of the stock. It is defined as the cube root of the molal average boiling point, T°R divided by the specific gravity at 60°/60 °F (15.6 °C).

$$K_{UOP} = \frac{T_B^{0.333}}{d} \tag{3.4}$$

where

- T_B = average boiling point, °R
- d = specific gravity 60°/60 °F

This factor has been shown to be additive on a weight basis. It was originally devised to show the thermal cracking characteristics of heavy oils, thus, highly paraffinic oils have K ~ 12.5 to 13, while cyclic (naphthenic) oils have K ~ 10.5 to 12.5.

The volume average boiling point (VABP), obtained either from True Boiling Point (TBP) distillation or American Society for Testing and Materials (ASTM) distillation, replaces T in the expression for K_{UOP}. Table 3.3 shows crude quality and product properties at different K_{UOP} grades.

In the case of a crude oil subjected to TBP distillation (given as volume),

Volume average boiling point: $T = \frac{T_{20} + T_{50} + T_{80}}{3}$
 or

In the case of a petroleum cut subjected to ASTM distillation:

Volume average boiling point: $T = \frac{T_{10} + 2T_{50} + T_{90}}{4}$

where T₂₀, T₅₀, T₈₀, T₉₀ are the temperatures at which 20, 50, 80 and 90 per cent by volume of a sample distills out.

It is found that highly paraffinic oils have K_{UOP} values from 12.5–13.0 and cyclic (naphthenic/aromatic) oil have K_{UOP} values from 10.5–12.5. Thus K_{UOP} values can differentiate between highly paraffinic and highly aromatic stocks but have problems in classifying naphthenic stocks from aromatic ones since their K_{UOP} values overlap.

Note: In the case of a mix, the characterization factor is determined as:

$$K_{mix} = K_1 W_1 + K_2 W_2 + K_3 W_3 + \dots \tag{3.5}$$

where

- K₁, K₂, K₃ = the respective characterization factors for different components.
- W₁, W₂, W₃ = the respective weight fractions.

3.1.6 Carbon Residue, wt%

This property is determined by reducing a sample to elemental carbon (coke) in the absence of air. It is a measure of the asphalt content of the crude oil and the quantity of lubricating oil fraction that may be recovered as product. It can also be used to establish the yields from coking processes and the coke deposited on the catalyst in catalytic cracking. The higher the carbon residue for a crude oil, the lower its value as a refinery feed stock.

Carbon Distribution

Methods for classifying crude oils become efficient when the distribution according to volatility and the

Table 3.3 Crude quality and product properties at different K_{UOP} grades.

$K_{UOP} = \frac{[1.8 \times (ABP + 273.15)]^{0.333}}{Sp.Gr_{60/60^{\circ}F}}$ <p>where ABP = Atmospheric boiling point, °C</p> <p>$Sp.Gr_{60/60^{\circ}F}$ = Specific gravity @15.4°C × (0.999544/0.99012)</p>				
	Crude quality	Naphtha	Kerosene	Gas oil
$K_{UOP} > 12.0$	Paraffinic	As ethylene cracker feed = Good As Platformer feed = Bad (C-Grade)	Smoke Point = Good Freeze Point = Bad	Cetane = Good Cloud Point = Bad
$K_{UOP} < 11.5$	Naphthenic	As Platformer feed = Good (A Grade) As ethylene cracker feed = Bad	Freeze Point = Good Smoke Point = Bad	Cloud Point = Good Cetane = Bad
$11.5 < K_{UOP} < 12.0$	Mixed Base	Product properties	are between Paraffinic	Naphthenic

Note: Brent crude is a mix of some mixed based crudes that can be naphthenic in light ends but paraffinic in heavy ends.

Table 3.4 Carbon distribution from n – d – M method.

n and d values at 20 °C		n and d values at 70 °C	
$V = 2.51(n - 1.4750) - (d - 0.8510)$		$V = 2.42(n - 1.4600) - (d - 0.8280)$	
$W = (d - 0.8510) - 1.11(n - 1.4750)$		$W = (d - 0.8280) - 1.11(n - 1.4600)$	
$V > 0$	$\%C_A = 430V + 3660/M$ $R_A = 0.44 + 0.055MV$	$V < 0$	$\%C_A = 410V + 3660/M$ $R_A = 0.41 + 0.0055MV$
$V < 0$	$\%C_A = 670V + 3660/M$ $R_A = 0.44 + 0.080MV$	$V > 0$	$\%C_A = 720V + 3660/M$ $R_A = 0.41 + 0.080MV$
$W > 0$	$\%C_R = 820W - 3S + 10,000/M$ $R_T = 1.33 + 0.146M(W - 0.005S)$	$W > 0$	$\%C_R = 775W - 3S + 11,500/M$ $R_T = 1.55 + 0.146M(W - 0.005S)$
$W < 0$	$\%C_R = 1440W - 3S + 10,600/M$ $R_T = 1.33 + 0.180M(W - 0.005S)$	$W < 0$	$\%C_R = 1440W + 12,100/M$ $R_T = 1.55 + 0.180M(W - 0.005S)$
$\%C_N = \%C_R - \%C_A$ $R_N = R_T - R_A$			
$\%C_A$ = weight per cent of aromatic carbon		R_A = number of aromatic rings in an average molecule	
$\%C_N$ = weight per cent of naphthenic carbon		R_N = number of naphthenic rings in an average molecule	
$\%C_p$ = weight per cent of paraffinic carbon		R_T = total number of rings in an average molecule	
$\%C_R$ = weight per cent of cyclic carbon		S = weight per cent sulfur	

characteristic properties of the various distillate fractions are known. Characterization of the various fractions of petroleum can be made using the n-d-M method (n: refractive index, d: density, M: molecular weight). This method allows determination of carbon distribution and thus shows the percentage of carbon in aromatic structure ($\%C_A$), the percentage of carbon in naphthenic structure ($\%C_N$) and the percentage of carbon in paraffinic structure ($\%C_p$). The value of n follows the order: n paraffins < n naphthenes < n aromatics

and it increases with molecular weight. Table 3.4 shows the carbon distribution for n and d values.

Table 3.4 is used mainly with vacuum distillates and lubricating oils and it requires the following:

Refractive index: this is one of the most precise measurements that can be carried out on a petroleum cut. The ASTM method D 1218 indicates a reproducibility of 0.00006. The refractive index is very often used in process operations because it shows small differences in product quality that are often missed by

other measurements. The only restriction is that the color of the sample should be < 5 on the ASTM D 1500 scale.

Molecular weight: for a mixture of components, the molecular weight is:

$$M = \frac{\sum n_i M_i}{\sum n_i}$$

where n_i = number of molecules of component i

M_i = molecular weight of component i .

3.1.7 Nitrogen Content, wt%

Nitrogen compounds in crude oils reduce the activity of cracking catalysts. High nitrogen content crude oil may require special processing to remove the nitrogen. Most of the nitrogen in crude oil is contained in the highest boiling fractions.

3.1.8 Sulfur Content, wt%

Sulfur is an undesirable impurity because of pollution and corrosion and sulfur content is measured in terms of weight percentage. Crudes that contain appreciable quantities of hydrogen sulfide (H_2S) or other relative sulfur compounds are referred to as "sour", whereas crudes low in sulfur are known as "sweet". Sour crudes require more extensive processing than low sulfur or "sweet" crude oils.

Sulfur content and API gravity have the greatest influence on the value of crude oil. It varies from trace levels to > 5 wt%. The split between sweet and sour crude is about 0.5% and the crossover is generally in the 0.5 to 1.5% range. The lower the API gravity, the higher the sulfur content, although there are exceptions to this rule. Further processing for sour crude oils involves hydrogen treating processes to convert the sulfur to H_2S , which can then be removed.

3.1.9 Total Acid Number (TAN)

The Total Acid Number is a measure of potential corrosivity; it quantifies the number of milligrams of potassium hydroxide (KOH) needed to neutralize 1 g of crude oil. A crude with a TAN > 1 mg KOH/g is usually considered corrosive and labeled a High-TAN crude, but corrosion problems can occur with a TAN as low as 0.3 [14]. Crudes that are so acidic can cause rapid corrosion in the distillation/fractionating columns, and require the use of expensive alloy steel equipment.

The gravity, sulfur and TAN of crude oil have important economic and technical impacts on refining operations. Heavy, sour crude requires more sophisticated processes to produce lighter, more valuable products and is more expensive to process as compared to light sweet crude. Light sweet crude is more valuable as well as cheaper to process because it yields more of the lighter, high-priced products than heavy crude. Acidity is increasingly important as the production of high-acid crudes from West Africa has steadily increased. Very few refineries are able to refine High-TAN crude oils, and therefore are sold at a discount to marker crudes [14]. Generally, refineries blend High-TAN crudes with other streams before processing.

3.1.10 Salt Content, pounds/1000 barrels

All crude oil contains some inorganic salts, generally in the form of chlorides. If the salt content exceeds 10 pounds/1000 barrels of crude oil, it is necessary to remove them prior to distillation to reduce corrosion in the crude distillation column and its overhead condensers.

3.1.11 Metals, parts/million (ppm) by weight

Many metals occur in crude oil with the most common being nickel, and vanadium. Metals tend to concentrate in the heavier fractions where they act as poisons in the catalytic and hydrogen cracking processes. Other metals include copper, zinc, iron and arsenic.

3.1.12 Pour Point ($^{\circ}F$ or $^{\circ}C$)

The pour point (ASTM D97) is used to determine the waxiness of petroleum oil. It is defined as a measure of the paraffinic or waxiness of a crude oil, as is a measure of its pumpability. Waxes are paraffins with long side chains, or long paraffins side chains attached to other hydrocarbon structures. A waxy crude oil has a high pour point; i.e., it solidifies at a temperature above room temperature. Conversely, a low pour point indicates an absence of paraffinic and/or a presence of aromatic compounds, as these tend to lower the pour point. A sample of oil is first heated to $115^{\circ}F$ ($46.1^{\circ}C$) to ensure complete

Table 3.5 Pour points of some crude oils.

Country	Crude	Pour point
Algeria	Hassid Messaoud	-76 °F (-60 °C)
Kuwait	Kuwait	-43.6 °F (-42 °C)
Libya	Dahra	30.2 °F (-1 °C)
Venezuela	Boscan	+59 °F (+15 °C)

liquefaction. It is then cooled to 90 °F (32.2 °C). The sample is then placed in a cooling bath that is maintained between 15–30 °F (-9 to -1.1 °C) below the pour point of the oil. The oil is removed from the bath at 5 °F (-15 °C) intervals and is tilted to determine whether the sample will flow. If no movement is detected within 5 seconds, the solid point has been reached. It is defined as the temperature 5 °F (-15 °C) above the solid point.

The same procedure is used to determine the cloud point of petroleum oil. This is the temperature at which a distinct cloudiness or formation of crystals appears in the bottom of the test jar. It is typically about 5 °F (-15 °C) higher than the pour point. Table 3.5 gives pour points of some typical crude oils.

3.2 Crude Oil Assay Data

A precise and complete analysis of a crude oil is referred to as crude assay. This is more detailed than a crude TBP curve. Crude oil assay data are available for most of the crude oils of the world; some data are company proprietary, but much available in open literature. The crude assay helps to assess the potential sales value of new oil and thus plan for its effective utilization.

The following sections cover the information obtained from an assay.

3.2.1 Whole crude oil average properties

Gravity, weight% sulfur, weight% nitrogen, pour point, viscosities, metal contents, weight percent carbon residue, Reid vapor pressure, salt content, flash point, % asphaltene, bottom sediment and water (BS & W), light hydrocarbon yields, ($C_1 - C_5$), and a boiling point curve are the properties of the oil given by an assay.

3.2.2 Fractional properties

These are the boiling point or cut-point range and yield on crude, research octanes for gasoline fractions,

smoke and freeze points for kerosenes, naphthene and aromatic contents for reforming stock, and cetane number for diesel fuels.

Crude oil assay data change over time for any oil. This is caused by two factors; firstly, the crude oil itself changes in composition, and secondly, a crude oil sample represents a mixture of the crude oil produced in various wells and fields so, as new ones are being brought on line, the composition of the mixture changes. It is good practice to request a confirming sample for a crude oil mixture being used in process design/simulation exercise.

3.3 Crude Cutting Analysis

The first seven crude cuts are pure components. They are the light ends and consist of H_2S , H_2 , C_1 , C_2 , C_3 , iC_4 , nC_4 . The iC_5 and nC_5 are together and therefore are treated as the eight cut with a TBP end point of 100 °F (38 °C). The sum of light ends through nC_5 should be equal to the lights vol% distilled at 100 °F (38 °C). However, if the two numbers do not agree, then the light ends yields are assumed to be correct and the TBP yields between 100 - 200 °F (38–93 °C) are adjusted to provide a smooth transition between light ends and the remaining TBP curve.

The ninth cut has a TBP cut point of 100–200 °F (38–93 °C). Each successive cut has a TBP end point of 20 °F (-7 °C) higher than the preceding component. The 63rd component has end point of 1200 °F (649 °C). The TBP end point of crude is difficult to estimate with any degree of accuracy in the laboratory and is therefore assumed to be 1292 °F (700 °C). The 64th cut is assumed to have a TBP cut range of 1200–1292 °F (649–700 °C). Tables 3.6 and 3.7 show crude assays of Middle East Arab extra light and heavy crudes.

3.4 Crude Oil Blending

Many refineries process more than one crude oil, each being transported to the refinery via pipelines, ships and trucks. Since most refineries do not have adequate crude oil storage to isolate the various crude oils, the storage tanks contain a mixture of the crude oils received by the refinery. Generally, crude blending is achieved by mixing good quality crudes with heavy low cost crudes to improve overall profitability for the refinery.

Table 3.6 Middle East: Arabian Extra Light 36.7.

Crude Data

Sample Date: 01/06/93

SG: 0.8386

API Gravity: 37.2

Analysis Date:

Sulfur: 1.38 wt%

Light Hydrocarbon Analysis													
	wt%	lv%											
Hydrogen sulfide	0.00	0.00											
Methane	0.00	0.00										wt%	lv%
Ethane	0.00	0.00											
Propane	0.07	0.12								Total to C3	0.07		0.12
Iso-butane	0.11	0.16											
N-butane	0.77	1.11	Total C4s	0.88	1.27					Total to C4	0.95		1.39
Iso-pentane	0.70	0.94											
N-pentane	1.40	1.86	Total C5s	2.10	2.80					Total to C5	3.05		4.19
Wide Cut Data													
TBP Cut Points	C	C5-95	95-175	C5-149	149-232	332-342	342-369	369-509	509-550	509+	550+		
Yield on Crude	wt%	7.91	14.36	15-75	16.35	21.50	5.05	20.68	4.46	18.72	14.26		
	lv%	9.86	16.03	19.88	17.44	21.47	4.82	19.07	3.97	15.93	11.96		
SG		0.6729	0.7512	0.7068	0.7859	0.8396	0.8794	0.9094	0.9418	0.9854	0.9998		
API Gravity		78.79	56.87	68.71	48.54	37.04	29.41	24.10	18.74	12.10	10.02		
Watson K factor		12.54	12.03	12.21	11.96	11.94	11.85	11.91	12.00	11.86	11.85		
Sulfur	wt%	0.009	0.028	0.019	0.069	0.921	2.095	2.288	2.480	3.140	3.347		
Mercaptan Sulfur	wt%	0.018	0.29	0.025	0.025	0.026	0.027	0.028	0.029	0.030	0.031		
Iso Paraffins	wt%	37.79	31.18	34.19	30.57	-	-	-	-	-	-		
Total Paraffins	wt%	86.77	64.88	76.45	58.93	-	-	-	-	-	-		
Naphthenes	wt%	11.49	19.60	16.15	18.42	-	-	-	-	-	-		
Aromatics	wt%	1.74	15.52	7.40	22.65	29.27	35.95	-	-	-	-		
Viscosity at 20 °C	cSt	-	0.87	-	1.39	5.07	18.15	109.80	1510.00	79860.00	411300.		
30 °C	cSt	-	0.77	-	1.20	3.94	12.39	62.02	647.10	2382.00	106500.		
50 °C	cSt	-	0.62	-	0.93	2.59	6.68	24.87	167.00	3365.00	11850.0		
80 °C	cSt	-	0.47	-	0.68	1.61	3.38	9.35	39.73	409.50	1099.0		
100 °C	cSt	-	0.40	-	0.56	1.25	2.40	5.78	19.86	146.90	343.50		

TBP Cut Points	C	C5-95	95-175	C5-149	149-232	332-342	342-369-	369-509	509-550	509+	550+
Cloud Point	C	-	-80.5	-	-56.7	-12.0	12.0	14.9	21.7	-	-
Freeze Point	C	-	-77.3	-96.5	-53.5	-9.0	14.3	-	-	-	-
Pour Point	C	-	-93.1	-	-59.5	-12.3	11.5	25.7	22.1	7.8	2.0
Aniline Point	C	-	49.3	-	57.1	70.6	76.2	83.1	92.3	102.1	105.1
Smoke Point	mm	-	-	-	24.7	19.6	-	-	-	-	-
Liminometer		-	-	-	55.3	41.9	-	-	-	-	-
Cetane Index		-	35.1	-	44.1	53.1	47.4	35.9	9.5	-	-
Heat Value	kcal/kg	10578	10469	10542	10396	10234	9960	9858	9743	9563	9507
RONC		56.27	39.53	46.37	18.56	-	-	-	-	-	-
RON + 0.15 g Pb/l		71.69	55.15	61.78	37.02	-	-	-	-	-	-
MONC		58.21	41.21	47.80	19.07	-	-	-	-	-	-
MON + 0.15 g Pb/l		69.95	54.82	61.40	34.83	-	-	-	-	-	-
Nitrogen	wt%	0.0	0.00	0.00	0.00	0.00	0.02	0.05	0.10	0.18	0.21
Vanadium	ppm	-	-	-	-	-	-	-	0.14	21.27	27.88
Nickel	ppm	-	-	-	-	-	0.00	0.00	0.07	3.81	4.89
RI at 70 °C		1.3974	1.3974	-	1.4165	1.4470	1.4696	1.4878	1.5077	1.5368	1.5459
Concarbon	wt%	-	-	-	-	-	-	0.18	1.72	14.83	18.93
Asphaltenes	wt%	-	-	-	-	-	-	-	0.00	1.90	2.49
BMCI		7.55	17.73	14.28	20.89	27.78	37.16	42.90	50.02	56.25	59.20
	wt%	1v%		wt%	1v%		wt%	1v%			
Cyclopentane	0.09	0.09	Total CC5			Total to CC5	0.09	0.09			
C6 iso paraffins	1.21	1.53									
C6 n-paraffins	1.58	1.99									
C6 naphthenes	0.49	0.53									
Benzene	0.09	0.08					0.07	0.12			

(Continued)

Table 3.6 Cont.

C7 iso paraffins	1.18									4.13		Total to C6		3.44	4.23
C7 n-paraffins	1.55														
C7 naphthenes	0.71														
Toluene	0.47														
					Total C7s	3.91			4.55			Total to C7	7.35		8.78
C8 iso paraffins	1.39														
C8 n-paraffins	1.41														
C8 naphthenes	0.80														
C8 aromatics	0.71														
					Total C8s	4.31		4.86				Total to C8	11.66		13.64
C9 iso paraffins	1.30														
C9 n-paraffins	2.55														
C9 naphthenes	0.76														
C9 aromatics	0.44														
					Total C9s	5.05		5.70				Total to C9	16.71		19.33
C10 iso paraffins	1.37														
C10 n-paraffins	1.21														
C10 naphthenes	0.78														
C10 aromatics	0.88														
					Total C10s	4.24		4.56				Total to C10	20.95		23.90
C11 iso paraffins	1.25														
C11 n-paraffins	1.06														
C11 naphthenes	1.06														
C11 aromatics	0.86														
					Total C11s	4.23		4.47				Total to C11	25.19		28.37

Crude sulfur	% wt	1.320	Crude Sg	Sg	0.8410	Crude API		36.7000
Crude viscosity 20	cst	5.990	Crude viscosity 30	cst	4.8100	Crude viscosity 40	cst	3.9600
Crude Pour Point	C	-39.000	Crude Acidity	mg koh/g	0.0500	Crude Concarbon	% wt	2.7000
Crude Asphaltenes	%wt	0.3500	Crude Vanadium	ppm	4.0000	Crude Nickel	ppm	2.0000
Crude salt content	lb/1000bb	2.1000	Crude water content	% vol	0.0500	N-paraffins C5-95	% wt	49.5000
N-paraffins 95-175	% wt.	30.6000	N-paraffins C5-149	% wt	40.3000	Acidity 149-232	mg koh/g	0.0090
Hydrogen 149-232	% wt	14.0500	Naphthalenes 149-232	% vol	0.03200	Color stab 149-232		1.0000
Wax content 232-342	% wt	2.2000	Acidity 232-342	mg koh/g	0.01000	Color stab 232-342		1.0000
Wax content 342-369	% wt	14.9000	Wax content 369-509	% wt	12.300	Basic N2 369-509	ppm	125.0000
Organic O2 369-509	% wt	0.0500	Acidity 369-509	mg koh/g	0.0200	Wax content 509-550	% wt	11.1000
Basic N2 509-550	ppm	225.0000	Acidity 509-550	mg koh/g	0.0600	Wax content 342+	% wt	11.5000
Wax content 369+	% wt	11.0000	Wax Melt Pt. 369+	C	53.000	Acidity 369+	mg koh/g	0.05000
Xylene Equiv. 369+		12.5000	Resins A 369+	% wt	8.000	Resins B 369+	% wt	1.0000
Pen At 25c 509+	m	0.0500	Softening Point 509+	C	25.0000	Wax content 509+	% wt	9.5000
Wax Melt Pt. 509+	C	62.0000	Pen At 25c 550+	m	0.0500	Softening Point 550+	C	25.0000
Xylene Equiv 550+		10.0000	Resins A 550+	% wt	12.0000	Resins B 550+	% wt	4.0000
Mcpentene 15-95	% wt	0.2600	Hexane 15-95	% wt	0.19000	C6 - iso-para 15-95	% wt	1.25000
22-dmthlbutane 15-95	% wt	0.0100	23-dmthlbutane 15-95	% wt	0.0800	2-mthlpentane 15-95	% wt	0.68000
3-mthlpentane 15-95	% wt	0.4800	N-heptane 15-95	% wt	0.66000	Mthylcyhexane 15-95	% wt	0.10000

Table 3.7 Middle East: Arabian Heavy 27.3.

Crude Data

Sample Date: 01/08/93

SG: 0.88874

API Gravity: 28.0

Analysis Date:

Sulfur: 2.90 wt%

Light Hydrocarbon Analysis													
	wt%	lv%											
Hydrogen sulfide	0.00	0.00											
Methane	0.00	0.00										wt%	lv%
Ethane	0.04	0.10											
Propane	0.39	0.68									Total to C3	0.43	0.78
Iso-butane	0.19	0.30											
N-butane	0.88	1.34	Total C4s	1.07	1.64						Total to C4	1.50	2.42
Iso-pentane	0.62	0.88											
N-pentane	1.13	1.59	Total C5s	1.75	2.47						Total to C5	3.25	4.89
Wide Cut Data													
TBP Cut Points	C	C5-95	95-175	C5-149	149-232	332-342	342-369-	369-509	509-550	509+	550+		
Yield on Crude	wt%	5.62	9.12	11.21	10.90	15.90	4.05	19.44	5.11	37.01	31.90		
	lv%	7.46	10.85	14.21	12.34	16.69	4.04	18.65	4.73	31.65	26.92		
SG		0.6683	0.7456	0.6997	0.7839	0.8396	0.8794	0.9094	0.9418	0.9854	0.9998		
API Gravity		80.22	58.29	70.73	49.02	37.04	29.41	24.10	18.74	12.10	10.02		
Watson K factor		12.55	12.12	12.31	12.00	11.94	11.85	11.91	12.00	11.86	11.85		
Sulfur	wt%	0.002	0.024	0.006	0.153	1.379	2.625	2.931	3.649	5.357	5.630		
Mercaptan Sulfur	wt%	0.001	0.001	0.001	0.001	0.001	0.001	0.001	0.001	0.001	0.001		
Iso Paraffins	wt%	39.38	32.51	35.86	31.30	-	-	-	-	-	-		
Total Paraffins	wt%	88.63	66.79	79.14	57.98	-	-	-	-	-	-		
Naphthenes	wt%	10.58	22.37	16.55	23.06	-	-	-	-	-	-		
Aromatics	wt%	0.79	10.84	4.31	18.96	30.07	43.15	-	-	-	-		
Viscosity at 20 °C	cSt	-	0.87	-	1.40	5.31	19.47	171.900	3284.00	4.0 E+07	4.0E+08		
30 °C	cSt	-	0.77	-	1.22	4.11	13.18	91.71	1253.00	7066000	6.0E+07		
50 °C	cSt	-	0.62	-	0.95	2.69	7.01	33.69	271.20	413000	2633000		
80 °C	cSt	-	0.48	-	0.70	1.66	3.51	11.63	54.43	18280.00	82910.0		
100 °C	cSt	-	0.40	-	0.58	1.29	2.48	6.93	25.27	3904.000	14760.0		

TBP Cut Points	C	C	C5-149	149-232	332-342	342-369-	369-509	509-550	509+	550+
Cloud Point	C	-	-82.2	-58.6	-15.20	9.0.0	29.2	38.5	-	-
Freeze Point	C	-	-778.2	-54.7	-11.3	12.0	-	-	-	-
Pour Point	C	-	-82.2	-58.6	-15.3	8.9	26.9	30.5	6.9	0.3
Aniline Point	C	-	54.8	59.7	68.0	71.0	76.5	80.2	85.0	85.8
Smoke Point	mm	-	-	26.1	-	-	-	-	-	-
Liminometer	-	-	-	58.7	-	-	-	-	-	-
Cetane Index	-	-	38.7	45.6	51.5	44.8	32.0	6.3	-	-
Heat Value	kcal/kg	10591	10477	10401	10214	9890	9761	9602	9259	9204
RONC		57.35	36.81	14.85	-	-	-	-	-	-
RON + 0.15 g Pb/l		72.51	52.33	33.56	-	-	-	-	-	-
MONC		59.45	38.26	15.12	-	-	-	-	-	-
MON + 0.15 g Pb/l		70.87	51.91	31.15	-	-	-	-	-	-
Nitrogen	wt%	0.0	0.00	0.00	0.00	0.02	0.07	0.13	0.43	0.48
Vanadium	ppm	-	-	-	-	-	0.10	0.61	162.13	188.01
Nickel	ppm	-	-	-	-	0.00	0.11	0.70	51.81	60.00
RI at 70 °C		-	1.424	1.4362	1.4596	1.4755	1.4953	1.5169	1.5717	1.5805
Concarbon	wt%	-	-	-	-	-	0.19	1.60	22.2	25.50
Asphaltenes	wt%	-	-	-	-	-	-	0.00	12.07	14.00
BMCI		8.23	15.00	19.74	30.31	41.70	49.910	58.10	66.12	68.78
	wt%	Iv%		Iv%		wt%	Iv%			
Cyclopentane	0.05	0.06	Total CC5		Total to CC5	0.05	0.06			
C6 iso paraffins	0.86	1.15								
C6 n-paraffins	1.05	1.41								
C6 naphthenes	0.31	0.36								
Benzene	0.03	0.03								

(Continued)

Table 3.7 Cont.

C7 iso paraffins	0.80	1.03	Total C6s	2.25	2.94	Total to C6	2.30	3.01
C7 n-paraffins	1.02	1.31						
C7 naphthenes	0.49	0.57						
Toluene	0.15	0.16						
			Total C7s	2.46	3.06	Total to C7	4.76	6.07
C8 iso paraffins	0.89	1.11						
C8 n-paraffins	0.88	1.10						
C8 naphthenes	0.53	0.61						
C8 aromatics	0.38	0.39						
			Total C8s	2.68	3.21	Total to C8	7.44	9.28
C9 iso paraffins	0.89	1.09						
C9 n-paraffins	1.71	2.10						
C9 naphthenes	0.57	0.64						
C9 aromatics	0.22	0.22						
			Total C9s	3.39	4.05	Total to C9	10.83	13.33
C10 iso paraffins	0.91	1.09						
C10 n-paraffins	0.77	0.93						
C10 naphthenes	0.61	0.66						
C10 aromatics	0.48	0.48						
			Total C10s	4.24	3.15	Total to C10	13.59	16.48
C11 iso paraffins	0.84	0.99						
C11 n-paraffins	0.67	0.80						
C11 naphthenes	0.90	0.97						
C11 aromatics	0.50	0.50						
			Total C11s	2.92	3.26	Total to C11	16.51	19.74

Crude sulfur	% wt	2.900	Crude Sg	Sg	0.8905	Crude API		27.3000
Crude viscosity 20	cst	47.100	Crude viscosity 30	cst	30.800	Crude viscosity 40	cst	21.300
Crude Pour Point	C	-51.000	Crude Acidity	mg koh/g	0.2300	Crude Concarbon	% wt	8.200
Crude Asphaltenes	%wt	4.500	Crude Vanadium	ppm	60.000	Crude Nickel	ppm	19.000
Crude salt content	lb/1000bb	2.6000	Crude water content	% vol	0.0500	N-paraffins C5-95	% wt	49.7000
N-paraffins 95-175	% wt.	32.2000	N-paraffins C5-149	% wt	41.6000	Acidity 149-232	mg koh/g	0.0340
Hydrogen 149-232	% wt	14.1400	Naphthalenes 149-232	% vol	0.4500	Naphthalenes 232-342	% vol	6.9700
Color Stab 149-232		1.000	Wax content 232-342	% wt	2.9000	Acidity 232-342	mg koh/g	0.1100
Color Stab 232-342		1.000	Wax content 369-509	% wt	13.3000	Wax content 369-509	ppm	10.6000
Basic N2 369-509	ppm	165.000	Organic O2 369-509	% wt	0.0500	Acidity 369-509	mg koh/g	0.2800
Wax content 509-550	% wt	9.10000	Basic N2 509-550	ppm.	365.000	Acidity 509-550	mg koh/g	0.32000
Wax content 342+	% wt	6.500	Wax content 369+	% wt	6.000	Wax Melt Pt 369+	C	56.000
Acidity 369+	mg koh/g	0.2300	Xylene Equiv. 369+		17.500	Resins A 369+	% wt	10.000
Resins B 369+	% wt	9.000	Pen At 25c 509+	m	0.0076	Softening Point 509+	C	48.000
Wax content 509+	% wt	3.5000	Pen At 25c 550+	m	0.0022	Softening Point 550+	C	62.5000
Xylene Equiv 550+		17.500	Resins A 550+	% wt	18.000	Resins B 550+	% wt	14.0000
Mcpentene 15-95	% wt	0.1800	Chexane 15-95	% wt	0.1100	C6 - iso-para 15-95	% wt	0.9300
22-dmthbutane 15-95	% wt	0.0100	23-dmthbutane 15-95	% wt	0.0700	2-mthlpentane 15-95	% wt	0.4600
3-mthlpentane 15-95	% wt	0.3900	N-heptane 15-95	% wt	3900	Mthylcyhexane 15-95	% wt	0.0600

3.5 Laboratory Testing of Crude Oils

3.5.1 True Boiling Point (TBP) Curve

The composition of any crude oil sample is approximated by a true boiling point (TBP) curve. The method for determining this is a batch distillation operation using a large number of stages, usually > 60, and high reflux to distillate ratio (> 5). The temperature at any point on the temperature-volumetric yield curve represents the true boiling point of the hydrocarbon material present at the given volume per cent point distilled. TBP distillation curves are generally found only on the crude and not on petroleum products.

The volatility of crude oil and petroleum fractions is characterized in terms of one or more laboratory distillation tests that are summarized in Table 3.8, namely the American Standard Testing Materials (ASTM) D86 and D1160 tests. The ASTM D86 distillation is a rapid batch distillation involving the equivalent of approximately one equilibrium stage and no reflux except for that caused by heat losses. The temperatures are reported at a pressure base of 1 atmosphere (760 mm Hg). For high-altitude laboratories the barometric pressure corrections to the observed temperatures are significant and must not be ignored. Table 3.9 shows temperature corrections for various laboratory barometric pressures. Figures 3.3 and 3.4 show snapshots of liquid volume (%) vs. temperature (°C) of TBP

and ASTM D86 distillation blend from Honeywell UniSim simulation software.

3.5.2 ASTM D86 Distillation

D86 distillation uses a simple Engler flask containing a calibrated thermometer to measure the temperature of the vapor at the inlet to the condensing tube. An inclined brass condenser in a cooling brass is attached, to remove all distilled vapors; no liquid reflux is returned to the flask. The condenser tube is cooled in an ice water bath to maintain the condensing temperature between 32 and 40 °F (0–4.5 °C). The light components that boil at temperatures lower than the condensing temperature are lost from the distilled product.

100 ml of sample is distilled and the vapor temperature against volume recovered is recorded. The *initial boiling point* (IBP) is defined as the temperature at which the first drop of liquid leaves the condenser tube. The *final boiling point* (FBP) or “end point” is the highest temperature recorded during the test. The total volume of the distillate is recorded as the recovery. Any liquid left in the still after the end point temperature is recorded is cooled and measured as the residue. The difference between 100 ml (initial sample volume) and the sum of the recovery and the residue is referred to as the loss. Repeated tests give ±6 °F for the initial boiling and end points. Intermediate distillation points are reproducible within 2 ml of distillate which corresponds to 6–7 °F. Figure 3.5 shows a modern TBP apparatus.

Table 3.8 Laboratory distillation tests.

Test name	Reference	Main applicability
ASTM (atmosphere)	ASTM D 86	Petroleum fractions or products, including gasoline turbine fuels, naphthas, kerosines, gas oils, distillate fuel oils, and solvents that do not tend to decompose when vaporized at 760 mm Hg
ASTM [vacuum often 10 torr (1.3 kPa)]	ASTM D 1160	Heavy petroleum fractions or products that tend to decompose in the ASTM D86 but can be partially or completely vaporized at a maximum liquid temperature of 750 °F (400 °C) at pressures down to 1 torr (0.13 kPa)
TBP [atmospheric or 10 torr (1.3 kPa)]	Nelson*, ASTM D 2892	Crude oil and petroleum fractions
Simulated TBP (gas chromatography)	ASTM D 2887	Crude oil and petroleum fractions
EFV (atmospheric, superatmospheric, or subatmospheric)	Nelson†	Crude oil and petroleum fractions

*Nelson, Petroleum Refining Engineering, 4th ed. Mc. Graw-Hill, New York, 1958, pp 95–99.

† Ibid, pp 104–105.

(Source; Perry's Chemical Engineer's Handbook, 7th ed., McGraw-Hill, 1997).

Table 3.9 Temperature corrections for barometric pressure.

Laboratory Pressure, mm Hg							
Observed Temp, °F	572	597	622	648	673	698	724
50	12	10	8	7	5	4	2
100	13	11	9	8	6	4	2
150	14	12	10	8	6	4	3
200	15	13	11	9	7	5	3
250	16	14	12	10	7	5	3
300	17	15	13	10	8	6	3
350	18	16	13	11	8	6	4
400	19	17	14	12	9	6	4
450	21	18	15	12	9	7	4
500	22	19	16	13	10	7	4
550	23	20	17	14	11	7	4
600	24	21	18	14	11	8	5
650	25	22	18	15	12	8	5
700	26	23	19	16	12	9	5

For use with ASTM D86 Distillation

Temperature corrections are in °F.

(Source: Gerald L. Kees, Refinery Process Modeling: A Practical Guide to Steady State Modeling of Petroleum Processes, The Athens Printing Co., Athens, Georgia, 2000)

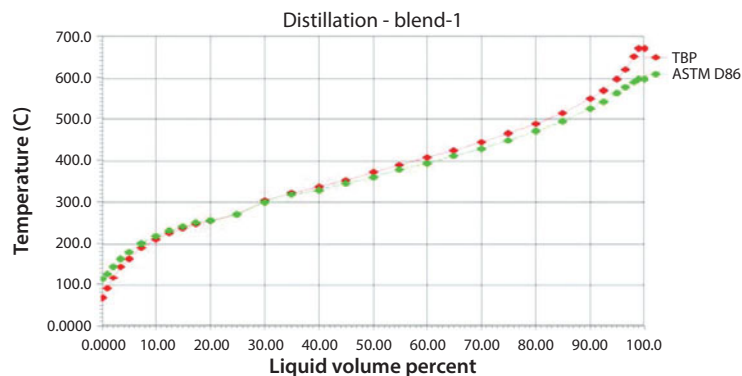


Figure 3.3 Snapshot of liquid volume (%) vs. Temperature (°C) of TBP and ASTM D86 plots of distillation blend (Courtesy of Honeywell UniSim software, Honeywell (R) and UniSim (R) are registered trademarks of Honeywell International Inc.).

3.5.3 Boiling Points

Figure 3.6 illustrates the inter-conversion between ASTM D-86 distillation 10% to 90% slope and the different boiling points used to characterize fractions of crude oil. This is done to determine the properties such as the volumetric average boiling (VABP) point, weight average boiling point (WABP), molal average boiling point (MABP), mean average boiling point (MeABP)

and cubic average boiling point (CABP). On the basis of ASTM D-86 distillation data, the VABP is [5]:

$$VABP = (t_{10} + t_{30} + t_{50} + t_{70} + t_{90}) / 5 \quad (3.6)$$

where the subscripts 10, 30, 50, 70 and 90 refer to the volume per cent recovered during the distillation. The 10% to 90% slope used as the abscissa in Figure 3.5 is:

$$slope = (t_{90} - t_{10}) / (90 - 10) \quad (3.7)$$

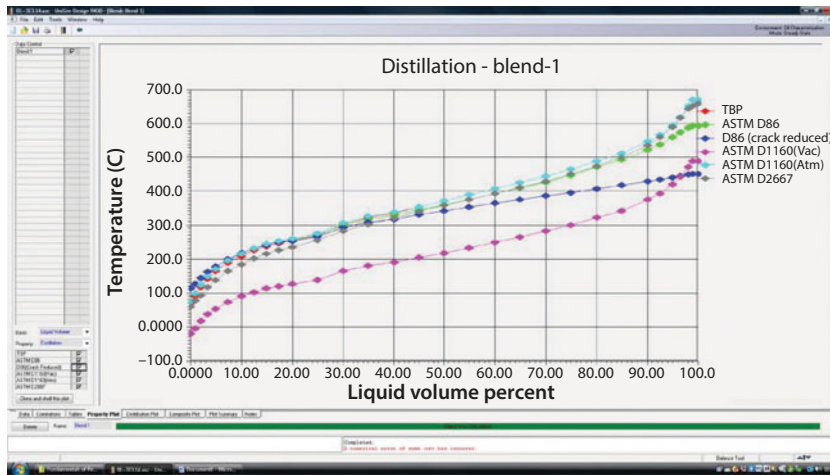


Figure 3.4 Snapshot of liquid volume (%) vs. Temperature (°C) of TBP, ASTM D86, D86 (Crack reduced), ASTM D1160 (Vac), ASTM D1160 (Am) and ASTM D2887 of distillation blend (Courtesy of Honeywell UniSim software, Honeywell (R) and UniSim (R) are registered trademarks of Honeywell International Inc.).

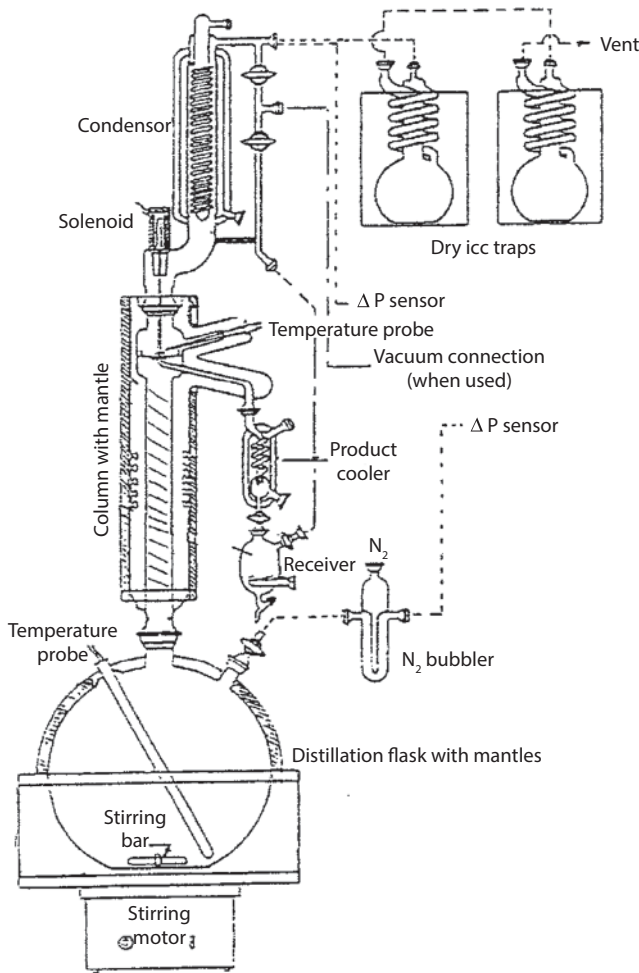


Figure 3.5 The True Boiling Point (TBP) distillation apparatus.

The use of Figure 3.6 is as follows:

- To locate the curve for the distillation VABP in the appropriate set for the type of boiling point desired.
- For a known 10–90% slope, to read a correction for the VABP from the selected VABP curve.

Example 3-1

Determine the mean average boiling point (MeABP) and the molecular weight for a 56.8 °API petroleum fraction with the following ASTM distillation data.

% Over	Temperature, °F
IBP	100
5	130
10	153
20	191
30	217
40	244
50	280
60	319
70	384
80	464
90	592
EP	640

(Source: *Engineering Data Book*: Gas Processors Suppliers Association, Tulsa, Oklahoma, 12th ed., 2004)

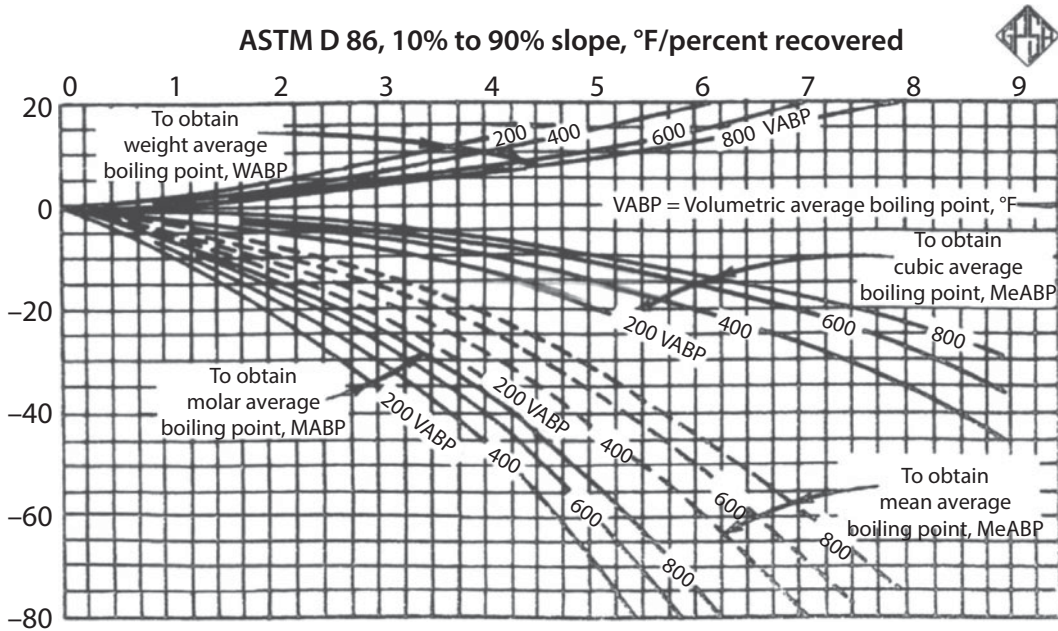


Figure 3.6 Characterizing Boiling Points of Petroleum Fractions (From API Technical Data Book). Used by permission, *Gas Processing Suppliers Association Book Data*, 12th ed., v.1 and 2. (2004).

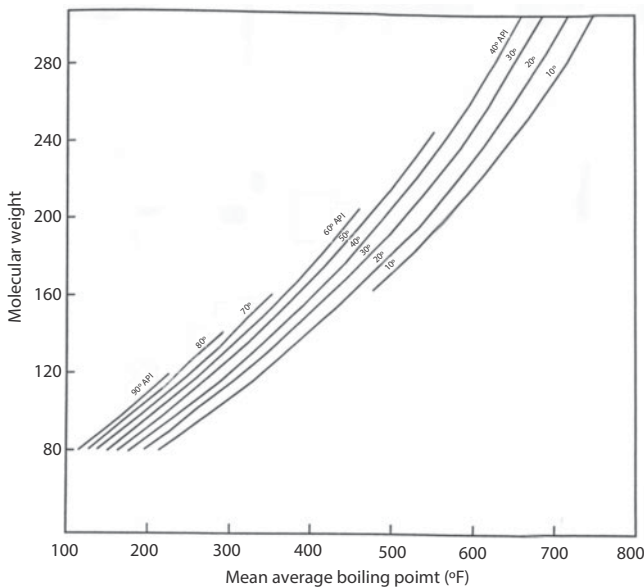


Figure 3.6a Correlations between MeABP, SpGr and Mol. Wt.

Solution

IBP = initial boiling EP = end point
 Slope $(592-153)/80 = 5.49$
 $VABP = (153 + 217 + 280 + 384 + 592)/5 = 325 \text{ }^\circ\text{F}$
 From Figure 3.6, Read down from a slope of 5.49 on the x-axis to the interpolated curve closest to 325 °F,

in the set drawn with the dashed lines (MeABP). Read across to obtain a correction value of -54 on the ordinate.

$$MeABP = 325 - 54 = 271 \text{ }^\circ\text{F.}$$

At $\phi_{API} = 56.8$, the molecular weight is 198 from Figure 3.6a.

3.5.4 Conversion Between ASTM and TBP Distillation

The True Boiling Point distillation determination of petroleum crudes can often be time consuming and tedious as compared to the ASTM method. Therefore, a correlation between ASTM and TBP distillation is employed that achieves the separation of TBP with little effort of the ASTM distillation. Riazi and Daubert [6] developed the following equation involving the conversion of ASTM to TBP referred to as the API method.

$$TBP = a(ASTMD86)^b \tag{3.8}$$

where a and b are constants varying with percent of liquid sample distilled as shown in Table 3.10. TBP is true boiling point temperatures at 0, 10, 30, 50, 70, 90 and 95 volume percent distilled, in degrees Rankine (°R). ASTM D86 is the observed ASTM D86 temperatures at corresponding volume percent distilled, in degrees

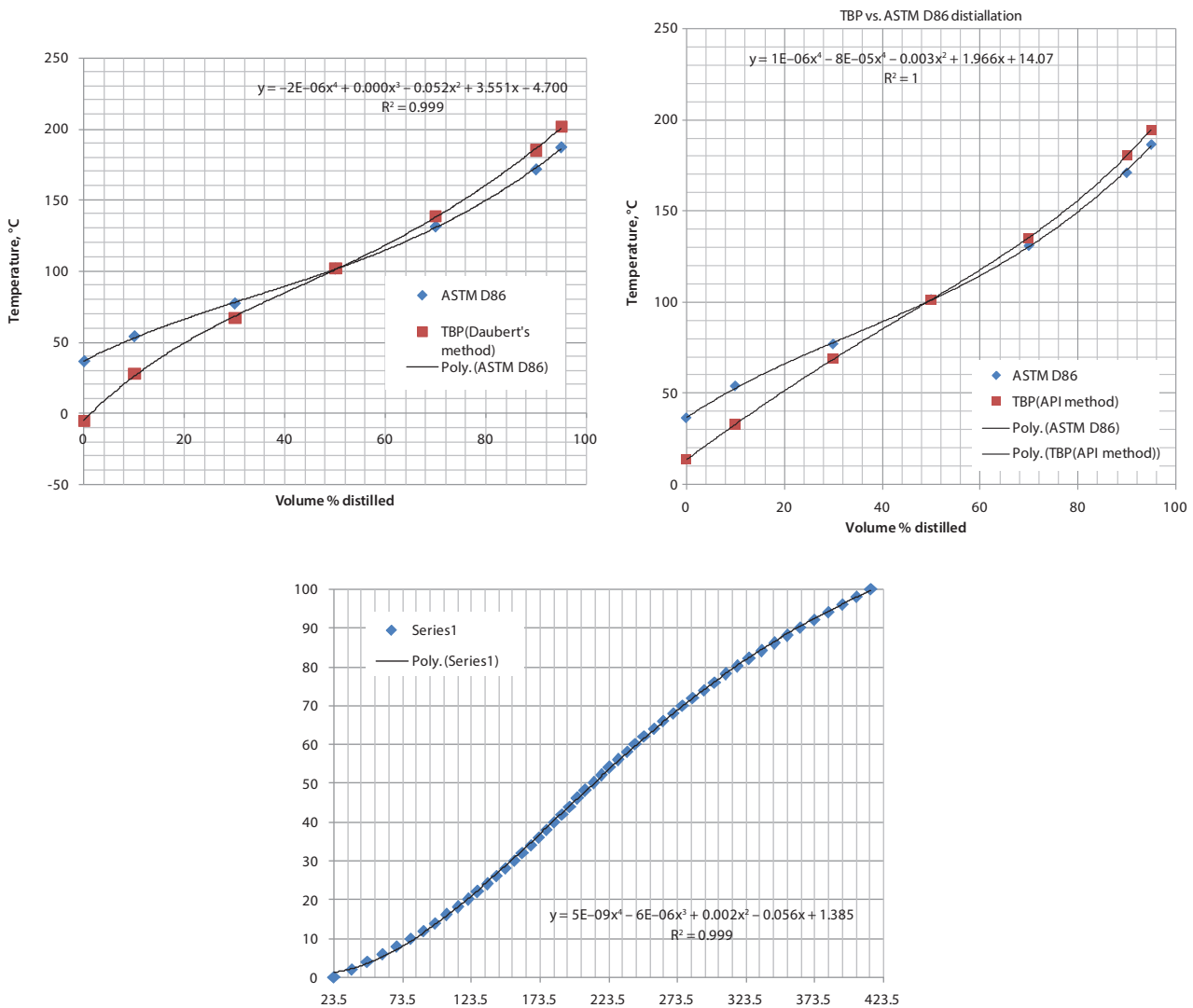


Figure 3.7 shows the Excel plots from Tables 3.10 and 3.11 (Example 3-1a.xlsx).

Rankine (°R). The average error between the calculated and measured TBP is in the range of 5 °C (41 °F).

Daubert [7] developed a new method for distillation curves inter-conversion using the following equations.

$$\begin{aligned}
 T'_{50} &= A_4 (T_{50})^{B_4} & T'_{30} &= T'_{50} - \Delta T'_3 & T'_{10} &= T'_{30} - \Delta T'_2 \\
 T'_0 &= T'_{10} - \Delta T'_1 & T'_{70} &= T'_{50} + \Delta T'_5 & T'_{90} &= T'_{70} + \Delta T'_6 \\
 T'_{95} &= T'_{90} + \Delta T'_7
 \end{aligned}
 \tag{3.9}$$

where

$$\begin{aligned}
 T'_i &= A_i (T_i)^{B_i} & \Delta T'_1 &= T_{10} - T_0 & \Delta T'_2 &= T_{30} - T_{10} & \Delta T'_3 &= T_{50} - T_{30} \\
 \Delta T'_4 &= T_{70} - T_{50} & \Delta T'_5 &= T_{70} - T_{50} & \Delta T'_6 &= T_{90} - T_{70} & \Delta T'_7 &= T_f - T_{90}
 \end{aligned}
 \tag{3.10}$$

The symbols T and T'_i refer to ASTM D86 and TBP temperatures respectively, both in °F. The subscripts 0 and f refer to the initial and final temperatures respectively. A_i and B_i are constants shown in Table 3.11. The

Table 3.10 Constants for Equation 3.8.

Volume% distilled	a	b
0	0.9167	1.0019
10	0.5277	1.0900
30	0.7429	1.0425
50	0.8920	1.0176
70	0.9490	1.0110
90	0.9490	1.0110
95	0.8008	1.0355

Table 3.11 Constants Daubert's distillation curves inter-conversion method.

Index number i	A _i	B _i
1	7.4012	0.6024
2	4.9004	0.7164
3	3.0305	0.8008
4	0.8718	1.0258
5	2.582	0.8200
6	3.0419	0.7750
7	0.1180	1.6606

reported average error for the Daubert's method is about 3 °C (37.4 °F).

From the distillation curve, the five different average boiling points can be estimated, and amongst these, the volume average boiling point (VABP) and the mean average boiling point (MeABP) are the most widely used in property estimation and design. The MeABP is used in the determination of Watson characterization factor K as expressed by:

$$K = \frac{(\text{MeABP})^{1/3}}{\text{SpGr}} \quad (3.11)$$

where

MeABP is in degrees Rankine (°R). From the ASTM D86 distillation, the VABP can be calculated from Equation 3.6

$$\text{VABP} = (t_{10} + t_{30} + t_{50} + t_{70} + t_{90}) / 5 \quad (3.6)$$

where the subscripts 10, 30, 50, 70 and 90 refer to the volume per cent recovered during the distillation and

all temperatures are °F. The 10% to 90% slope is:

$$\text{slope} = (t_{90} - t_{10}) / (90 - 10) \quad (3.7)$$

The MeABP is determined by:

$$\text{MeABP} = \text{VABP} - \Delta \quad (3.12)$$

where

$$\ln \Delta = -0.94402 - 0.00865(\text{VABP} - 32)^{0.6667} + 2.99791(\text{slope})^{0.333} \quad (3.13)$$

Figure 3.7 shows the Excel plots from Tables 3.10 and 3.11 (Example 3-1a.xlsx).

Example 3-2 (M. A. Fahim, *et al. Fundamentals of Petroleum Refining* [8]).

A petroleum cut has the following ASTM D86 distillation data

Volume% distilled	0	10	30	50	70	90	95
Temperature °C	36.5	54	77	101.5	131	171	186.5

Convert these data to TBP data using the API method and Riazi and Daubert and Daubert's method. Plot the results and compare. If the API gravity of this fraction is 62, calculate the Watson's characterization factor.

Solution

Microsoft Excel program (Example 3-2.xlsx) is used for Example 3.2, and the results for the API methods and of Raizi and Daubert (Equation 3.8), and Daubert (Equation 3.9) are shown in Tables 3.12 and 3.13, Figures 3.8a and 3.8b respectively.

Volume average boiling point (VABP) is:

$$\text{VABP} = 224.2 \text{ °F } (106.9 \text{ °C})$$

$$\begin{aligned} \text{Slope} &= \frac{(t_{90} - t_{10})}{(90 - 10)} = \frac{(339.8 - 129.2)}{80} \\ &= 2.6325 \end{aligned}$$

$$\ln \Delta = -0.94402 - 0.00865(VABP - 32)^{0.6667} + 2.9979(\text{Slope})^{0.333}$$

Mean average boiling point (MeABP) is:

$$\text{MEABP} = \text{VABP} = 224.4 - 18.3 = 206.1 \text{ }^\circ\text{F} (96.8 \text{ }^\circ\text{C})$$

$$^\circ\text{API} = 62$$

$$\text{Specific gravity} = 141.5 / (62 + 131.5) = 0.731$$

Watson characterization factor from Equation 3.11 is:

$$K = \frac{(206.1 + 460)^{1/3}}{0.731} = 11.92$$

Figure 3.8b shows the relationship between ASMT D86 and TBP (Daubert’s method) for percent volume distilled.

The Raizi and Daubert correlation resulted in predicting TBP distillation curves that were inconsistent with the point by point approach to inter-conversion, sometimes predicted TBP distillation curves with regions of negative slope for petroleum streams with small boiling point ranges. Because of this inconsistency, this correlation has not been widely accepted by petroleum refiners. Daubert provided an improved correlation over Riazi and Daubert correlation and reported that it’s more accurate than the older Edmister, *et al.* [9, 10] correlation. However, there is insufficient industrial experience with the new correlation to confirm the claim by Daubert.

Generally, ASTM and TBP distillation can be carried out on crude oils and petroleum products. The petroleum fractions are referred to as “cuts” from the crude oil with specific boiling point range

Table 3.12 Method of Riazi and Daubert using Equation 3.8.

Index number, i	Volume% distilled	a	b	Temp D86 °C	Temp D86 °F	TBP °R	TBP °F	TBP °C (Eq 3.8)
1	0	0.9167	1.0019	36.5	97.7	517.4	57.4	14.1
2	10	0.5277	1.09	54	129.2	552	92	33.3
3	30	0.7429	1.0425	77	170.6	616.1	156.1	68.9
4	50	0.892	1.0176	101.5	214.7	674.9	214.9	101.6
5	70	0.8705	1.0226	131	267.8	735.3	275.3	135.2
6	90	0.949	1.011	171	339.8	816.9	356.9	180.5
7	95	0.8008	1.0355	186.5	367.7	841.4	381.4	194.1

Table 3.13 Method of Daubert.

Index number, i	Volume% distilled	A _i	B _i	Temp D86 °C	Temp D86 °F	ΔT	ΔT’ °F	TBP °F	TBP °C (Eq 3.9)
1	0	7.4012	0.6024	36.5	97.7	31.5	59.14	22.42	-5.32
2	10	4.9004	0.7164	54	129.2	41.4	70.57	81.56	27.53
3	30	3.0305	0.8008	77	170.6	44.1	62.86	152.13	66.74
4	50	0.8718	1.0258	101.5	214.7		0	214.99	101.66
5	70	2.5282	0.82	131	267.8	53.1	65.67	280.66	138.14
6	90	3.0419	0.775	171	339.8	72	83.67	364.33	184.63
7	95	0.118	1.6606	186.5	367.7	27.9	29.68	394.01	201.12

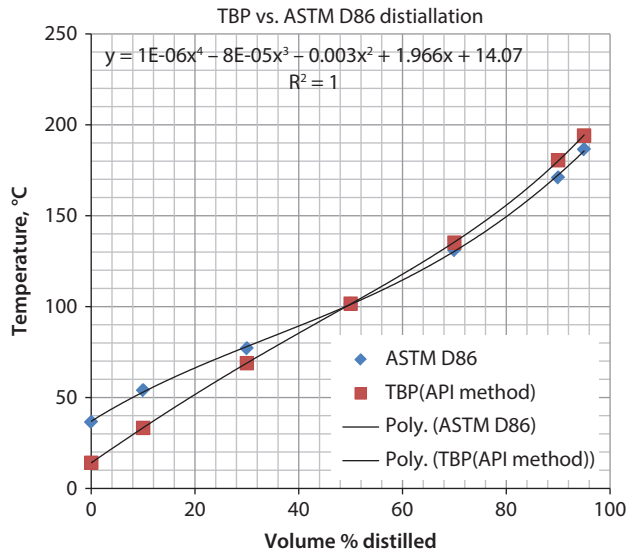


Figure 3.8a Conversion of ASTM D86 to TBP.

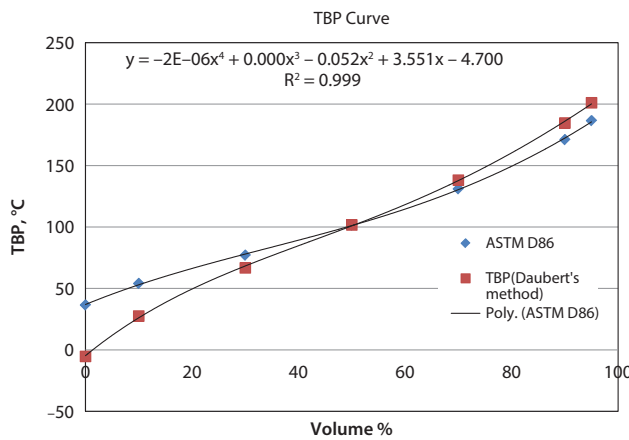


Figure 3.8b The relationship between ASMT D86 and TBP (Daubert's method) for percent volume distilled.

and with special properties as API gravity and viscosity. Each of these cuts can be further defined by dividing them into narrow boiling fractions known as pseudo (not real) components. For these pseudo-components, the average boiling point can be estimated as either mid-boiling point or mid-percentage boiling point. The TBP curve is divided into an arbitrary number of pseudo-components. The mid-percentage boiling point is the temperature at the arithmetic average of the volumes distilled at initial boiling point (IBP) and end point (EP) of that pseudo-component. Since the boiling range is small, both the mid-points are close to each other and can be considered as the VABP or the MeABP for that pseudo-component.

Example 3-3

A naphtha fraction has the following ASTM D86 distillation data:

Volume%	Temperature, °C
0.0	138.8
10.0	149.6
30.0	158.8
50.0	165.8
70.0	169.9
90.0	178.1
95.0	180.4

Obtain the TBP curve using the API method. Extrapolate the curve to 100% volume distilled. Plot the

Table 3.14 Method of Daubert

Index number, i	Volume% distilled	A_i	B_i	Temp D86 °C	Temp D86 °F	ΔT_i	ΔT_i °F	TBP °F	TBP °C
1	0	7.4012	0.6024	138	280.4	20.88	46.16	228.76	109.31
2	10	4.9004	0.7164	149.6	301.28	16.56	36.61	274.92	134.96
3	30	3.0305	0.8008	158.8	317.84	12.6	23.05	311.53	155.29
4	50	0.8718	1.0258	165.8	330.44		0	334.58	168.1
5	70	2.5282	0.82	169.9	337.82	7.38	13.02	347.6	175.33
6	90	3.0419	0.775	178.1	352.58	14.76	24.5	372.1	188.94
7	95	0.118	1.6606	180.4	356.72	4.14	1.25	373.35	189.64
	100			199.7	391.5				205.19

volume percent versus specific gravity for the naphtha fraction knowing that its specific gravity is 0.801.

Solution

Excel program (Example 3-3.xlsx) is used to determine TBP, and the results and plots are shown in Table 3.14 and Figure 3.9 respectively. Figure 3.10 shows the Volume distilled (%) vs. Specific gravity of TBP curve.

Volume average boiling point (VABP) is:
 $VABP = 328.0 \text{ }^\circ\text{F} (164.4 \text{ }^\circ\text{C})$

$$\text{Slope} = \frac{(t_{90} - t_{10})}{(90 - 10)} = \frac{(352.58 - 310.28)}{80} = 0.6413$$

$$\ln \Delta = -0.94402 - 0.00865(VABP - 32)^{0.6667} + 2.9979(\text{Slope})^{0.333}$$

$$\Delta = \exp \left\{ \begin{array}{l} -0.94402 - 0.00865(VABP - 32)^{0.6667} \\ + 2.9979(\text{Slope})^{0.333} \end{array} \right\} = 3.515$$

Mean average boiling point (MeABP) is:

$$MeABP = VABP = 328.0 - 3.515 = 324.5 \text{ }^\circ\text{F} (162.5 \text{ }^\circ\text{C})$$

$$^\circ\text{API} = 45.2$$

$$\text{Specific gravity} = 141.5 / (45.2 + 131.5) = 0.801$$

Watson characterization factor from Equation 3.11 is:

$$K = \frac{(324.5 + 460)^{1/3}}{0.801} = 11.49$$

3.5.5 Petroleum Pseudo-Components

In unit operation computations, it is essential to represent all process streams with discrete components for which thermophysical properties may be defined. However, most of the actual components are unknown for petroleum streams; petroleum pseudo-components are developed to represent the unknown components in these streams. Pseudo-components represent pre-defined boiling point ranges or cut-point ranges on the TBP distillation curve for the stream being characterized. Each pseudo-component corresponds to several unknown actual components.

Three correlating parameters are used to estimate thermophysical properties for petroleum pseudo-components, namely: normal boiling point, specific gravity and molecular weight. Any one of these components can be determined from the other two. However, for pseudo-components, these parameters are the weight averaged for the TBP cut-point range of the pseudo-component. The compositions for all flow streams in computations are represented with actual components and pseudo-components. Laboratory distillations and various other physical properties are determined for these streams from their compositions. Once these parameters are determined, the pseudo-components can be treated as any defined component for the calculation of thermophysical and thermodynamic properties as enthalpy, entropy and physical properties as viscosity, thermal conductivity, specific heat, diffusivity, etc. Properties such as

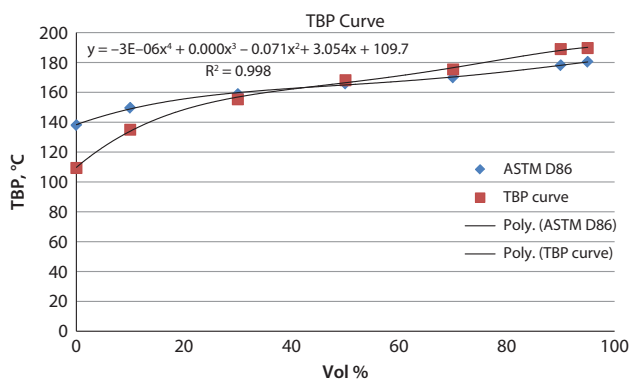


Figure 3.9 Extrapolation of TBP curve.

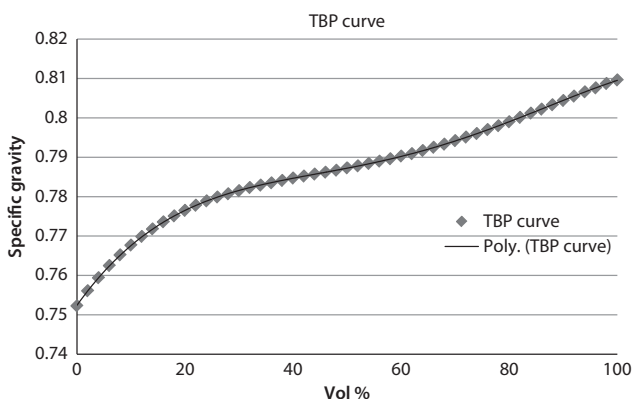


Figure 3.10 Volume (%) vs. specific gravity of TBP curve.

pour point depend on the chemical nature of the compounds represented in the pseudo-components, thus the information on the chemical compositions in terms of percentage of paraffins, naphthenes and aromatics is essential.

3.5.6 Pseudo-Component Normal Boiling Points

The development of pseudo-components is defining their cut-point ranges on the stream true boiling point (TBP) distillation curve. The TBP for the crude oil or the petroleum fractions has to be available either by direct laboratory measurements or through ASTM D1160 distillation or through the conversion of ASTM D86 distillation into TBP distillation curve. Pseudo-component cut-point ranges are next defined and applied to the actual or predicted TBP distillation curve. The normal boiling point (NBP) for each pseudo-component is defined as the weight average temperature for its cut-point range. TBP cut-point ranges are used to define the pseudo-components, with the average temperature of the cut-point range defined as the pseudo-component normal boiling point. If the petroleum fraction contains lighter than pentanes, the composition of the lighter ends has to be available experimentally through chromatographic analysis of the vapors. Otherwise, the lighter ends are lumped with the lightest pseudo-component. The number of such pseudo-components depends on the boiling point range of the whole petroleum fractions. Such a number is often a trade-off between having too few cuts that result in a model that does not predict a continuous smooth distillation for the process streams or having too many components which could result in excessive computation time in a typical refinery distillation operation.

The following cut-point ranges are reasonable for most refining computations:

TBP range, °F	TBP range, °C	Number of cuts
<100	<37.8	Use actual components (pentanes and lighter)
100–800	37.8–427	28
800–1200	427–649	8
1200–1600	649–871	4

A general guideline for determining the number of pseudo-components is:

- 50 °F (10 °C) for lighter fractions with boiling points less than 392 °F (200 °C)
- 59 °F (15 °C) for fractions with boiling points between 392–752 °F (200–400 °C)
- 68 °F (20 °C) for fractions with boiling points between 752–1112 °F (400–600 °C)
- 86 °F (30 °C) for fractions with boiling points beyond 1112 °F (600 °C).

The number of pseudo-components depends on the application and the final selection of cut-point ranges for a model depends on the distributed components in the fractionation zones. In distillation calculations, more NBP cuts might be required to represent narrow boiling products. Figure 3.11 shows how the TBP curve is cut into several pseudo-components.

3.5.7 ASTM D1160 Distillation

This is designed for high boiling point samples in which there is significant cracking at atmospheric laboratory pressures. Typical samples for which D1160 distillations are useful are heavy heating oils, cracker gas oil feeds, and residual oils. The test is similar to the ASTM D86 method, but the sample is distilled at a reduced pressure to inhibit cracking. The distillation pressure commonly selected for ASTM D1160 tests is 10 mm Hg. All observed D1160 temperatures are pressure corrected to their equivalents at 760 mm Hg.

At 10 mm Hg, petroleum stocks can be distilled to a maximum boiling point temperature equivalent to 950–1000 °F (510–538 °C) at 760 mm Hg. Lower pressures are sometimes used to extend this boiling point range for residual stocks. The reduced pressure used for D1160 distillations produces a better separation of components than D86 distillation. The D1160 method closely approximates the TBP method, and the temperatures recorded for 50% distilled and higher samples are assumed to be identical to the corresponding TBP temperatures. The D1160 method is sometimes used to extend the TBP distillation curve for mixtures containing high boiling materials.

3.5.8 Determination of ASTM IBP, 10%, 20–90% Points of Blend

This method is applicable to blends containing distillate stocks having an ASTM initial boiling point higher than 85 °F and an ASTM end point lower than 700 °F. It

is based on the observation that a straight summation line can be drawn through an ASTM distillation point of a blend.

The slope of the line must be such that the sum of the proportions of each blend component corresponds to its intersection with ASTM distillation curve. For TBP distillation, the summation lines are parallel to volume per cent axis on an ASTM distillation plot. ASTM summation lines slope due to poor fractionation of ASTM distillation and the slope varies according to distillation end point. The following are the slopes for varying distillation points [11].

Distillation point	Slope of summation line, °F
IBP	-180 °F per 100% distilled
10%	-180 °F per 100% distilled
20%	-100 °F per 100% distilled
30%	-80 °F per 100% distilled
40%	-50 °F per 70% distilled
50-90%	-20 °F per 70% distilled

3.5.9 ASTM 10-90% Points

ASTM distillation curves are drawn for each blend component with the temperature on the vertical axis and the volume percent distilled on the horizontal axis. Distillation must be done on a consistent basis for all components, i.e., either percent evaporated or percent recovered.

A guess is made on the temperature at which a given proportion of the blend is distilled, and the

corresponding point is marked on the graph. A summation line of specified slope is drawn through the point. The vol% distilled is read off vertically below the intercept of the summation line and ASTM distillation curve of each component (Figure 3.12). The sums for all blend components should equal the proportion of blend originally estimated, otherwise a new guess of temperature at which the specified proportion of blend is distilled is made and the procedure repeated.

Where the second estimate does not produce the required result, an interpolation is made between the two estimates.

3.5.10 Initial Boiling Point Determination

This method is identical to 10-90% points of blend, except that the distillation curves for the components are extrapolated to -1.4%. Therefore, -1.4% becomes new zero of the modified scale and 10% becomes 11.4%. The volume distilled at 1.4% is next estimated by the previous procedure to give the IBP of the ASTM curve.

3.5.11 ASTM End Point of Blend

The end point of a two-component blend is referred to as the function of the end point, proportion of blend component, and slope of the tail of the distillation curve of the higher-boiling component.

3.5.12 Flash Point

The flash point is a measure of the volatile components in a petroleum middle distillate. It is dependent on the predicted solubility for the light hydrocarbons in the middle distillate. Various attempts have been made to correlate flash points for petroleum distillates, and all attempts use the predicted ASTM 86, 10% distilled temperature as a correlating parameter.

The flash point test determines the temperature at which the vapors from petroleum oil will ignite or "flash". Three basic procedures are used to determine this: the Cleveland open cup method (ASTM D92), the Penskey Martens (ASTM D93) and the Tag (ASTM D 53) closed cup methods.

A sample is heated at a specified rate and an open flame introduced into the emitted vapors at specified time intervals. The temperature at which the vapors

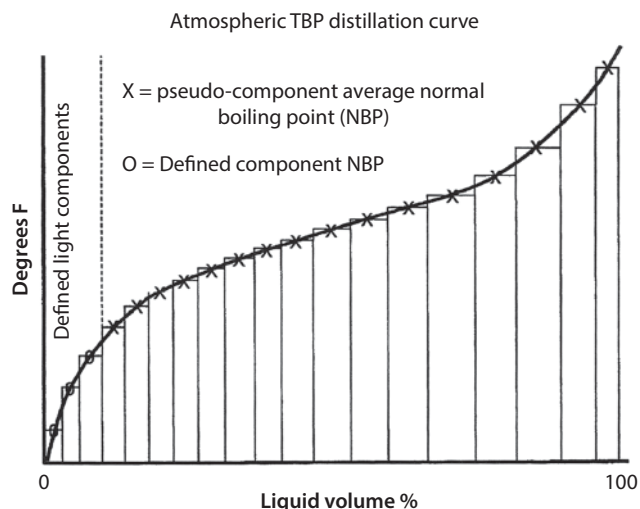


Figure 3.11 Representation of TBP curve by pseudo-components.

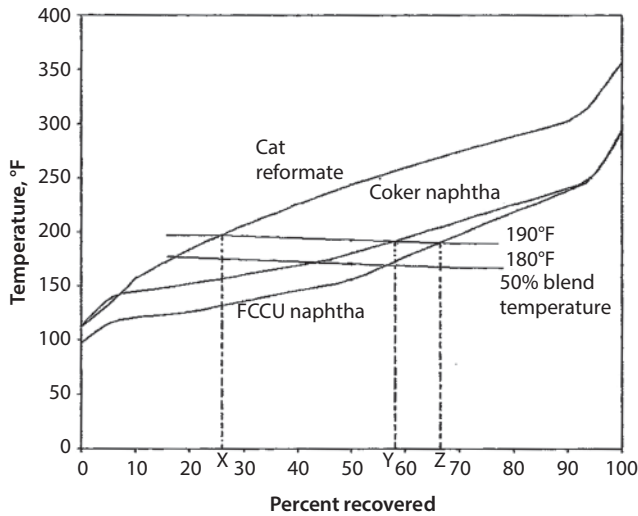


Figure 3.12 ASTM distillation blending practice (Source: Parkash, R., *Refining Processes Handbook*, Elsevier, Gulf Professional Publishing 2003).

ignite is recorded as the flash point. The open cup method is often used because of its simplicity. Below flash points of 510 °F, the open cup flash point is approximately 10 °F higher than the closed cup flash point for the same sample. The open cup method heats the oil at a rate of 10 °F per minute with the test flame applied at 30 sec. intervals. Accuracy for this method is ± 5 °F. The closed cup tester heats the oil at a rate of 1.8 °F per minute and is the more precise of the two methods.

Measurement of vapor pressure and flash point of crude oils allows the assessment in the amount of light hydrocarbons present. Generally, crude oils with a vapor pressure greater than 0.2 bar at 37.8 °C have a flash point less than 20 °C. Table 3.15 shows the Reid vapor pressure and flash point of some crudes.

3.5.13 Flash Point, °F, as a Function of Average Boiling Point

The correlation is applicable up to 1050 °F [11]:

Flash =	0.535T - 93, if (T ≤ 174 °F)
Flash =	0.67T - 116, if (174 ≤ T ≤ 303 °F)
Flash =	0.7506T - 140.3, if (303 ≤ T ≤ 577 °F)
Flash =	0.674T - 94.5, if (577 ≤ T < 1050 °F)

Table 3.15 Reid vapor pressure and flash point of some crudes.

Country	Crude	Reid vapor pressure (bar)*	Flash point, °C
Nigeria	Bonny Light	0.26	<20
Iraq	Kirkuk	0.29	<20
Qatar	Qatar	0.50	<20
Kuwait	Kuwait	0.51	<20
Venezuela	Bachaquero	0.06	46

*The Reid vapor pressure being expressed in psi (1 psi = 6.9kPa).

3.5.14 Smoke Point of Kerosenes

The smoke point (S) of kerosene can be estimated by the following correlation with the aromatic content of the stream.

$$S = \left(53.7 / \text{arom}^{0.5} \right) + 0.03401 \text{API}^{1.5} + 1.0806 \quad (3.14)$$

where

- S = Smoke point, mm
- arom = aromatic content, LV%
- API = API gravity of the cut.

3.5.15 Luminometer Number

The luminometer number is qualitatively related to the potential radiant heat transfer from the combustion products of aviation turbines fuels. It provides an indication of the relative radiation emitted by combustion products of gas turbines fuels.

The luminometer number (L_n) is related to the smoke point by following correlation (ASTM specification D-1740):

$$L_n = -12.03 + 3.009SP - 0.0104SP^2 \quad (3.15)$$

$$SP = 4.16 + 0.331L_n + 0.000648L_n^2 \quad (3.16)$$

where

- L_n = the luminometer number
- SP = The smoke point.

3.5.16 Reid Vapor Pressure (RVP)

The Reid vapor pressure test is used to determine the front-end volatility of products in the gasoline through heavy reforming naphtha boiling point range.

It correlates with the normal butane content of the sample, and the RVP of gasoline blends is adjusted by adding or removing normal butane. For gasoline, the RVP is 8–14 psi, and the percentage of butanes in the stream is the same as the RVP. The value is always reported in absolute pressure units of psi, kPa, bar, etc.

The test procedure for gasolines and naphthas involves combining one part of chilled liquid sample at 36 °F (2.6 °C) with four parts laboratory air at 70 °F (21.4 °C) in a bomb that has a pressure gauge attached to the lid. The bomb is placed in a constant temperature bath at 100 °F (37.8 °C) and when the pressure reaches a constant value, this is recorded as the Reid vapor pressure. Table 3.16 shows the Reid vapor pressure for gasoline streams with the largest deviations occurring for the samples at the highest vapor pressures. The Reid vapor pressure measurements have been used to assess the amount of light hydrocarbons that may be lost during filling and draining operations of tanks.

$$\text{Losses (volume \%)} = \frac{RVP - 1}{6} \quad (3.17)$$

The Reid vapor pressure is expressed in psi (1 psi = 6.9 kPa). Table 3.15 shows the RVP of some crude oils. Measurement of the vapor pressure and flash point of crude oils indicates the amount of light hydrocarbons present. Crude oils with a vapor pressure > 0.2 bar at 37.8 °C have a flash point < 20 °C.

3.5.17 Vapor Pressure of Narrow Hydrocarbon Cuts

Vapor pressure of narrow hydrocarbon cuts can be estimated from their boiling points and temperature by correlation of Van Kranen and Van Ness [11]:

$$x = 6.07918 - (3.19837) \frac{(232.0 + B) \left[\frac{(1120 - T)}{(1120 - B)} \right]}{(232 + T)} \quad (3.18)$$

where

$$VP_{mmHg} = 10^x \quad (3.19)$$

$$VP_{psi} = 10^x \cdot 0.01932 \quad (3.20)$$

where

B = average boiling point, °C

Table 3.16 Relationship between the True and Reid Vapor Pressure for Miscellaneous Volatile Products.

Product	Vapor pressure, psi		Ratio
	Reid	True	True/Reid
Natural gasoline	24.0	26.2	1.09
Natural gasoline	20.0	21.8	1.09
Natural gasoline	18.4	20.1	1.092
Natural gasoline	17.8	20.3	1.14
Natural gasoline	16.0	17.5	1.09
Light gasoline	14.0	15.4	1.10
Light gasoline	12.0	12.9	1.07
Natural gasoline	12.0	12.9	1.07
Gasoline	10.0	10.4	1.04
Straight-run gasoline	8.3	9.7	1.17
Gasoline	8.0	8.3	1.04
Gasoline	6.0	6.3	1.04
Refinery gasoline	5.9	7.2	1.16
Gasoline	5.0	5.2	1.04
Gasoline	3.0	3.1	1.03
Gasoline	2.0	2.1	1.05

(Source: W.L. Nelson, *Petroleum Refinery Engineering*, 4th Ed., McGraw-Hill Book Co., New York, p 133, [1958]).

T = temperature, °C

VP_{mmHg} = vapor pressure, mm Hg

VP_{psi} = vapor pressure, psi.

Figure 3.13 is a nomograph of the vapor pressures of gasolines and finished petroleum products.

3.6 Octanes

The octane test is used to measure the knocking characteristics of a fuel in a laboratory gasoline engine. The engine is calibrated by measuring the knocking value of a standard material; 2-2-4 trimethyl pentane (224 TMP). By definition, an octane number of 100 is assigned to 224 TMP. The knocking value of the test sample is compared to that of the standard member to determine its octane number.

3.7 Cetanes

The cetane number is used to measure the performance of a fuel in a diesel engine. Although determined in a laboratory engine (ASTM engine test D613), it is

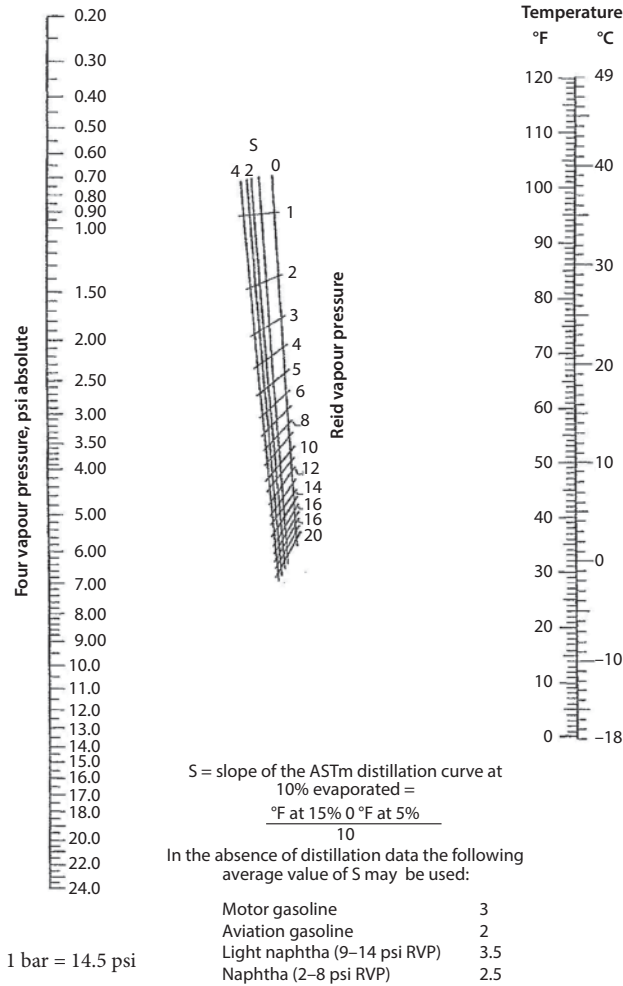


Figure 3.13 Vapor pressures of gasolines and finished petroleum products, 1–20 psi RVP (Source: Physical and Engineering Data, Shell, January 1978).

calculated with a formula that relates cetane number, API gravity and ASTM D86, 50% distilled.

All the laboratory tests are used to determine the qualities of feedstocks and products from petroleum processes. They are essential in design and simulation since they can be used to define petroleum pseudo-components to represent the streams for the unit operations calculations.

3.7.1 Cetane Index

The cetane index (CI) is estimated from the API gravity and 50% ASTM distillation temperature in °F of the diesel. It is defined by [12]:

$$CI = -420.34 + 0.016(API)^2 + 0.192(API)\log(M) + 65.01(\log M)^2 - 0.0001809M^2 \quad (3.21)$$

or

$$CI = 454.74 - 1641.416D + 774.74D^2 - 0.554B + 97.803\log(B)^2 \quad (3.22)$$

where

- API = API gravity
- M = mid-boiling temperature, °F
- D = density at 15 °C
- B = mid-boiling temperature, °C

3.8 Diesel Index

The diesel index (DI) is correlated with the aniline point of diesel as:

$$DI = \text{aniline point} \times API/100 \quad (3.23)$$

The relationship between diesel index and cetane index of diesel is:

$$DI = (CI - 21.3)/0.566 \quad (3.24)$$

3.9 Determination of the Lower Heating Value of Petroleum Fractions

If the API gravity of distillate is above 42°, the net heat (H) of combustion in Btu/lb can be determined as follows:

$$H = 8505.4 + 846.81K + 114.92API + 0.12186API^2 - (9.951)(K)(API) \quad (3.25)$$

If the API gravity of distillate or residue is below 42°, the net heat (H) of combustion in Btu/lb can be determined as follows:

$$H = 17213 + 5.22API - 0.5058API^2 \quad (3.26)$$

Correct the preceding heating values for sulfur content of the distillate or residue.

$$\text{Heat} = H(1 - 0.01S) + 43.7S \quad (3.27)$$

where

- Heat = lower heating value, Btu/lb.
- K = Watson characterization factor
- API = API gravity
- S = Sulfur content (%)

3.10 Aniline Point Blending

The aniline point of gas oil is indicative of its aromatic content. Aromatic hydrocarbons exhibit the lowest and paraffin the highest values. Aniline point (AP) blending is not linear, and therefore blending indices are used.

The conversion of aniline point to the aniline index is:

$$ANLIND = 1.25AP + 0.0025(AP)^2 \quad (3.28)$$

or, alternatively the aniline point is:

$$AP = 200 \left[\left(1.5625 + \frac{ANLIND}{100} \right)^{0.5} - 1.25 \right] \quad (3.29)$$

where

ANLIND = the aniline index
AP = the aniline point.

Nelson [13] presents four fundamental principles for the operation of crude columns and other multi-draw columns as:

1. The yield of a given product is primarily a function of the composition of the feed mixture, not the degree of separation.
2. The number of trays only slightly alters the boiling range of the products as defined by ASTM initial boiling points (IBP) and end points.
3. The initial boiling point of side draw products is always low, and it must be corrected by either steam stripping or reprocessing.
4. The end point of a side draw product is primarily controlled by opening or closing the draw valve to change the yield.

3.11 Correlation Index (CI)

An early classification methodology is based on the bulk residue in distillation. If the residue contains less than 2% wax then it is classified as asphaltic. If residue contains more than 5% wax then it is referred to as paraffinic. Another methodology refers to the chemical composition of the 250 - 300°C fraction as shown in Table 3.17. This method created a difficulty, since, in the fractions boiling above 200°C, the molecules can no longer be placed in one group because most of them are of a typically mixed nature. Purely naphthenic or aromatic molecules occur very seldom; cyclic

compounds generally contain paraffinic side-chains and often even aromatic and naphthenic rings side by side; correlation index (CI) provides more direct chemical information.

This index, developed by the U.S. Bureau of Mines, is based on the plot of specific gravity at 60/60 °F versus the reciprocal of the boiling point in degrees Kelvin for pure hydrocarbons on which the line described by the constants of the individual members of the normal paraffin series is given a value of CI = 0, and a parallel line passing through the point for the values of benzene is given as CI = 100. From this plot, the following empirical equation is derived:

$$CI = 473.7d - 456.8 + (48640/K) \quad (3.30)$$

where K is the average boiling point, determined by the Bureau of Mines standard distillation method and d is the specific gravity.

The values of the index between 0 and 15 indicate a dominance of paraffinic hydrocarbons in the fraction; values from 15 to 50 indicate dominance either of naphthenes or mixtures of paraffins, naphthenes and aromatics; values above 50 show aromatic character. Correlation Index (CI) is used to estimate chemical composition of fluid catalytic cracking (FCC) feeds, and to determine the yields of products in the text.

Table 3.17 provides a very comprehensive classification, and most crude oils found worldwide can be classified as paraffin, intermediate or naphthene. Heavy oils are also classified according to a term known as "characterization gravity", defined as the "arithmetic average of the instantaneous gravities of the distillates boiling at 177 °C, 232 °C and 288 °C vapor line temperature at 25 mm Hg pressure in a true boiling point distillation".

Additionally, a method of petroleum classification that is based on other properties, as well as the density of selective fractions, has been developed. The method consists of a preliminary examination of the aromatic content of the fraction boiling up to 145 °C as well as that of the asphaltene content, followed by a more detailed examination of the chemical composition of the naphtha (B.pt. < 200° C). For this analysis, a graph is used which is a composite of curves expressing the relation between percentage distillate from the naphtha, the aniline point (this is used to find out the paraffin-naphthene ratio), refractive index, specific gravity and the boiling point.

3.12 Chromatographically Simulated Distillations

Gas chromatography methods have been developed to predict the boiling point distribution corresponding to that determined by the detailed TBP method. Four standard tests are currently employed by refinery test laboratories, namely: D3710, D2887, D2887 extended, and HTSD. Table 3.18 summarizes simulated distillation procedures. The methods of operation for each are similar, and the most commonly used method is illustrated in ASTM Standard D 2887-73. This method is limited to petroleum fractions with a final boiling point of 1000 °F (538 °C). The sample must also have a boiling point range ≥ 100 °F (≥ 55 °C). Carbon disulfide (CS_2) is used for the carrier gas. The chromatographic column is first calibrated with a standard mixture of normal paraffins hydrocarbons. A calibration curve of retention time in the column versus normal boiling point is developed for normal paraffins by increasing the column temperature and recording the areas of each recorded peak of the individual components

at timed intervals. The sample is next introduced into the column; the retention times and the areas of the sample components are recorded. The components in the sample are then assigned boiling points by using the calibrated curve developed for the normal paraffin standard.

Crude oils and heavy residues have such high boiling points that the column temperature cannot be increased sufficiently to measure the highest boiling fractions. Hence, the total area of the sample cannot be known and the boiling point curve for the sample cannot be determined accurately for these streams. HTSD is a modification to the D2887 procedure and extends the boiling range distribution of hydrocarbon to a final boiling point ≈ 1382 °F (750 °C). A careful choice of chromatographic conditions is used to cause the high boiling components to be eluted from the column some 500–600 °F (260–316 °C) below their normal boiling points, and as such provides great potential for analysis of heavy petroleum residues.

All the classification systems mentioned above are based on the assumption that an oil can be more or

Table 3.17 Classification of petroleum fractions according to specific (API) gravity.

Light (B.pt 250–270 °C) fraction			Heavy (B.pt. 275–300 °C) fraction			
Class	API 60°/60 °F	Sp. Gr. 60°/60 °F	Type	API 60°/60 °F	Sp. Gr. 60°/60 °F	Type
Paraffin	>40.0	<0.8251	Paraffinic	>30.0°	<0.8762	Paraffinic
Paraffin - Intermediate	>40.0°	<0.8251	Paraffinic	20.1°–29.9°	0.9334–0.8767	Intermediate
Intermediate-Paraffin	33.1°–39.9°	0.8597–0.8256	Intermediate	>30.0°	<0.8762	Paraffinic
Intermediate	33.1°–39.9°	0.8597–0.8256	Intermediate	20.1°–29.9°	0.9334–0.8767	Intermediate
Intermediate-Naphthene	33.1°–39.9°	0.8597–0.8256	Intermediate	< 20.0°	>0.9340	Naphthenic
Naphthene-Intermediate	<33.0°	>0.8602	Naphthenic	20.1°–29.9°	0.9334–0.8767	Intermediate
Naphthene	<33.0°	>0.8602	Naphthenic	<20.0°	>0.9340	Naphthenic
Paraffin-Naphthene	>40.0°	<0.8251	Paraffinic	<20.0°	>0.9340	Naphthenic
Naphthene	33.0°	>0.8602	Naphthenic	>30.0°	<0.8762	Paraffinic

Table 3.18 Simulated distillation procedures.

Method	Application	Standard	Range	Report Basis
D3710	gasolines, naphthas	$C_5 - C_{15}$	<500 °F	volume%
D2887	cycle oils, gas oils	$C_5 - C_{44}$	<1015 °F	weight%
D2887 - ext.	heavy gas oil, crude	$C_5 - C_{60}$	<1140 °F	weight%
HTSD	heavy gas oil, crude	$C_5 - C_{120}$	<1382 °F	weight%

Note: The standard is a mixture of normal paraffins with carbon number ranges as shown.

less characterized by the properties of one or of a few fractions, but the properties of certain fractions of a crude oil are definitely not always reflected in those of other fractions of the same oil. Some crudes have a different chemical character in low-boiling and high-boiling fractions. Therefore, any method of classification in which the properties of a certain fraction are extrapolated to the whole crude oil, must be applied with caution, as serious errors can arise. It is usually necessary to combine a boiling range analysis with the carbon distribution in the various fractions to gain a reasonable perspective of the crude.

References

- Haddad, H. N., and D. B. Manley, "Improve crude oil fractionation by distributed distillation", *Hydrocarbon Processing*, pp 93–108, May, 2008.
- Manjoorana, Koch, B. S., "Modern Petroleum Chemistry: An overview", Kannatheri Publication, Karla, India, 2003.
- Nelson, W. L., *Oil & Gas Journ.*, pp 125, March 25, 1968.
- Characterization of Petroleum Fractions, *Ind. Eng. Chem.*, 27, 1460, 1935.
- Engineering Data Book*, Gas Processing Suppliers Association, Vol. 2, 12th ed., Section 19, Tulsa, Oklahoma, 2004.
- Riazi, M. R., and T. Daubert, "Simplify property prediction", *Hydrocarbon Proc.*, 3, pp 115–116, 1980.
- Daubert, T. E., "Petroleum Fraction Distillation Interconversions", *Hydrocarbon Proc.*, pp 75–78, Sept. 1994.
- Fahim, M. A., Al-Shahaf, T. A., and A. S. El-Kilani, *Fundamentals of Petroleum Refining*, Elsevier, 2010.
- Edmister, W. C. and D. H. Pollock, "Phase Relations for Petroleum Fractions", *Chem. Eng. Prog.*, vol. 44, p 905, 1948.
- Edmister, W. C., and K. K. Okamoto, "Applied Hydrocarbon Thermodynamics – Part 12: Equilibrium Flash Vaporization Correlations for Petroleum Fractions", *Petroleum Refiner*, Vol. 38, No. 8, p 117, 1959.
- Parkash, S., *Refining Processes Handbook*, Gulf Professional Publishing, Elsevier, 2003 .
- ASTM Test method specification D976–80.
- Nelson, W. L., "Regulation of I.B.P. and E.P", *Oil & Gas Journ.*, p 143, August 25, 1945.
- Bacon, R. and S. Tordo., "Crude oil price differentials and differences in oil qualities: A statistical analysis, ESMAP Technical Paper 081, Energy Sector Management Assistance Program, Washington, D.C., Oct. 2005.

4

Thermodynamic Properties of Petroleum and Petroleum Fractions

Introduction

Petroleum refining comprises various piping systems, pressure vessels as heat exchangers, distillation/fractionating towers, storage vessels, rotating equipment as pumps and compressors. The proper and adequate analysis and design of these equipment items require knowledge of thermodynamic and physical properties of the petroleum fluids. For example, the design of piping systems in the refining requires knowledge of the physical properties as viscosity, density and surface tension for two-phase petroleum fluids. Designing a crude distillation/fractionating tower requires knowledge of vapor-liquid equilibrium ratios (K values) on each of the trays in the column, enthalpies involving heat transfer calculations. In vapor-liquid equilibrium separation (referred to as “flash” separation), K values are used in a calculation procedure to determine the vapor and liquid portions of a mixture at a given temperature and pressure. One or two liquid phases are considered to be in equilibrium with one homogeneous vapor phase. Calculation methods for K values include equations of state, liquid activity coefficients

and empirical formulas. The design of a rotating equipment as a compressor requires knowledge of entropies for isentropic calculations such as compression and expansion; the compressibility factor of the gas, as well as the ratio of the specific heat at constant pressure to that at constant volume, and that of a pump requires knowing the viscosity and the density of the petroleum fluids.

Due to complexity in the composition of petroleum and petroleum fractions, it is often difficult to measure or compute accurately all these properties. For example, the accuracy from the equation of state is improved by tuning factors that are relied on pure component binary vapor-liquid equilibrium data. Liquid activity coefficients are determined with standard equation's forms incorporating predetermined coefficients. These data and other parameters are stored in thermodynamic data banks in commercial simulators. Further, process and petroleum refining engineers have developed methods and correlations to estimate the properties of petroleum and petroleum fractions such as normal boiling point (NBP) and specific gravity (SpGr) as illustrated in chapter 3, as such methods and

correlations characterize these petroleum fractions. For crude oils, mixture of bulk properties cannot be employed to estimate the properties in the mixture. For narrow boiling fractions, mixture of properties such as the average boiling point, specific gravity and molecular weight are used to predict many other properties.

It is useful to estimate physical and transport properties for the feed and product streams in a simulation model. These properties may be determined using the individual component contributions or calculated based on the average properties for the stream. Properties calculated from individual component data include stream total in mole, weight, and volume units and stream density. Transport properties such as viscosities, thermal conductivities and liquid surface tension are commonly determined using the principle of corresponding states.

Table 4.1 shows thermodynamic properties that are essential for the design and operation of these equipment items in the refining operation, and Figure 4.1 shows typical vapor-liquid equilibrium equipment in determining the compositions of the phases. Figure 4.2 shows a distillation column with column plates, controls and accessories.

Figure 4.3 illustrates a photograph of the column plates and its schematics with the direction of vapor and liquid flows.

4.1 K-Factor Hydrocarbon Equilibrium Charts

Hydrocarbon systems are among those for which most data have been developed. See following paragraph on K-factor charts. For systems of chemical components

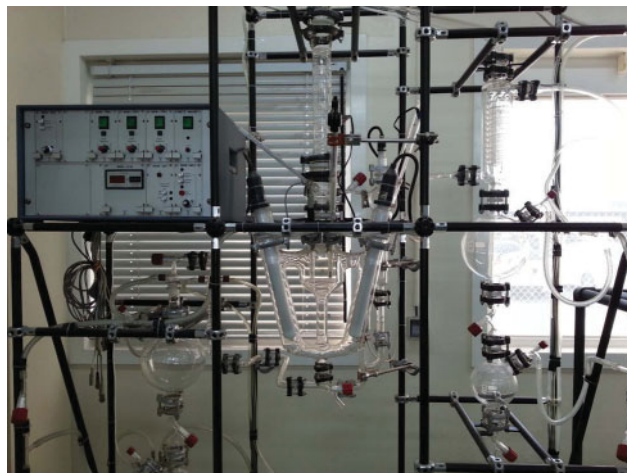


Figure 4.1 Photograph of Vapor-Liquid Equilibrium apparatus.



Figure 4.2 Laboratory distillation column with controls and accessories.

Table 4.1 Thermodynamic property prediction.

Thermodynamic properties
Enthalpy
Entropy
Heat capacity
Compressibility factors
Equilibrium K-values
Flash curves
Transport properties
Viscosity
Thermal conductivity
Diffusivity
Physical properties
Density
Volumes

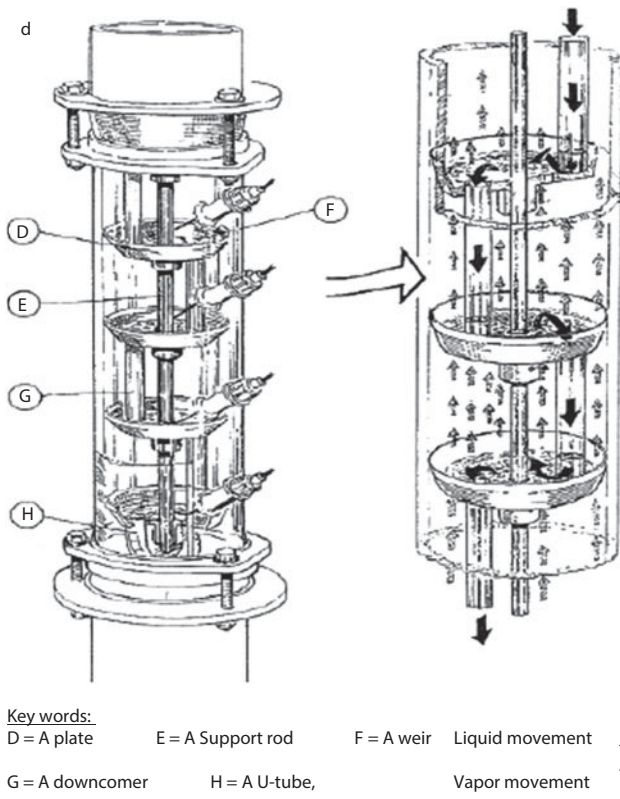


Figure 4.3 Schematics of a pilot plant distillation column plates showing liquid and vapor movements (Courtesy of Armfield, U.K.).

where such factors are not developed, the basic relation is:

$$K_i = \frac{y_i}{x_i} = \frac{\gamma_i P_i^*}{\phi_i P} \quad (4.1)$$

For ideal systems: $y_i = \phi_i$

where

K_i = mol fraction of component, i , in vapor phase in equilibrium divided by mol fraction of component, i , in liquid phase in equilibrium

K_i = equilibrium distribution coefficient for system's component, i

p_i^* = vapor pressure of component, i , at temperature

P = total pressure of system = π

γ = activity coefficient

ϕ = fugacity coefficient

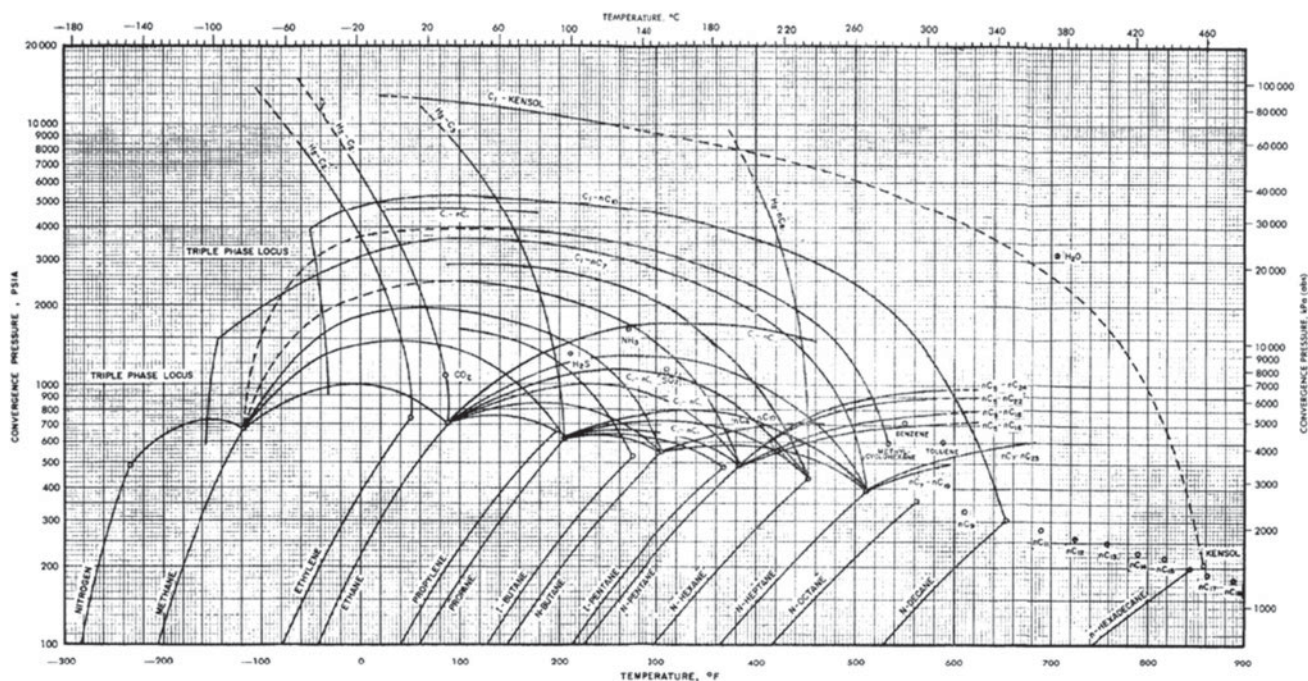
The concept of ideality is usually a good approximation for close boiling components of a system, where the components are all of the same "family" of hydrocarbons or chemicals; for example, a mixture of paraffin hydrocarbons. When "odd" or non-family components are present, or if the system has a wide boiling range the possibility of deviations from non-ideality becomes greater.

Ideal conditions are often assumed for preliminary calculation, followed by more rigorous design methods. These may be completely satisfactory, particularly when the activities of the individual components approximate to 1.0. Many process components do not, however, conform to the ideal gas laws for pressure, volume and temperature relationships. If ideal concepts are applied to such cases, erroneous results will be obtained if this behavior is assumed to hold. Errors are not serious when the deviation from ideal is not significant. When data are available to confirm the ideality or non-ideality of a system, then the choice of approach is much more straightforward.

K-factors for vapor-liquid equilibrium ratios are usually associated with various hydrocarbons in the presence of some common impurities as nitrogen (N_2), carbon dioxide (CO_2), and hydrogen sulfide (H_2S) [1]. The K-factor is ($K_A = y_A/x_A$), i.e., the equilibrium ratio of the mole fraction of a component in the vapor phase divided by the mole fraction of the same component in the liquid phase. K is generally considered a function of the mixture composition, in which a specific component occurs, plus the temperature and pressure of the system at equilibrium.

The Gas Processors Suppliers Association [2] provides a detailed background development of the K-factors and the use of convergence pressure (see Figures 4.4a–4.4d), i.e., the pressure of the system at a temperature when vapor-liquid separation is no longer possible. Convergence pressure alone does not represent a system's composition effects in hydrocarbon mixtures, but the concept does provide a rather rapid approach for systems calculations and is used for many industrial calculations. These are not well adapted for very low temperature separation systems. Figure 4.4d shows the chart of equilibrium constant for methane-ethane binary system.

The charts of reference [2] are for binary systems unless noted otherwise. The convergence pressure method can usually predict the equilibrium composition with reasonable accuracy for vapor and liquid phases around the convergence pressure and corresponding temperature. The convergence pressure is the pressure where all proportions of vapor and liquid focus to a point (converges). Generally, vapor and liquid cannot coexist at a pressure than the convergence pressure. The K values of the components (binary) approach 1.0. Typically, the convergence pressure is higher than the critical pressure of either of the pure components [3].



NOTE: See TP-22 for an explanation of the development of this figure.

Figure 4.4a Convergence pressures of hydrocarbons (critical locus). Used permission, Gas Processors Suppliers Association Data Book, 12th Ed., V.1 and 2 (2004), Tulsa, Okla.

The convergence pressure generally is a function of the liquid phase, and assumes that the liquid composition is known from a flash calculation using a first estimate for convergence pressure, and is usually the critical pressure of a system at a given temperature. The following procedure is recommended by [2]:

Step 1. Assume the liquid phase composition or make an approximation. (If there is no guide, use the total feed composition).

Step 2. Identify the lightest hydrocarbon component that is present at least 0.1 mole% in the liquid phase.

Step 3. Calculate the weight average critical temperature and critical pressure for the remaining heavier components to form a pseudo binary system. (A shortcut approach suitable for most hydrocarbon systems is to calculate the weight average T_c only).

Step 4. Trace the critical locus of the binary mixture consisting of the light component and pseudo heavy component. When the averaged pseudo heavy component is between two real hydrocarbons, an interpolation of the two critical loci must be made.

Step 5. Read the convergence pressure (ordinate) at the temperature (abscissa) corresponding to that of the desired flash conditions, from Figure 4.4a [2].

Step 6. Using the convergence pressure determined in Step 5, together with the system temperature and system pressure, obtain K-values for the components from the appropriate convergence-pressure K-charts.

Step 7. Make a flash calculation with the feed composition and the K-values from Step 6.

Step 8. Repeat Steps 2 through 7 until the assumed and calculated convergence pressures agree within an acceptable tolerance.

For n-pentane at convergence pressure of 3,000 psia (nearest chart), the K-value reads 0.99 (see Figure 4.4c), and other K-values are shown in Appendix A. The DePriester charts [4] provide a reasonable check on this (Figures 4.5a, b, c and d). Interpolation between charts of convergence pressure can be calculated, depending on how close the operating pressure is to the convergence pressure. The K-factor charts (or K-values) do not change rapidly with convergence pressure, P_k (psia) [2].

For light hydrocarbons, approximate K values can be determined from the nomographs prepared by DePriester as illustrated in Figures 4.5a, b, c and d for different temperature ranges. If temperature and/or pressure of the equilibrium mixture are unknown,

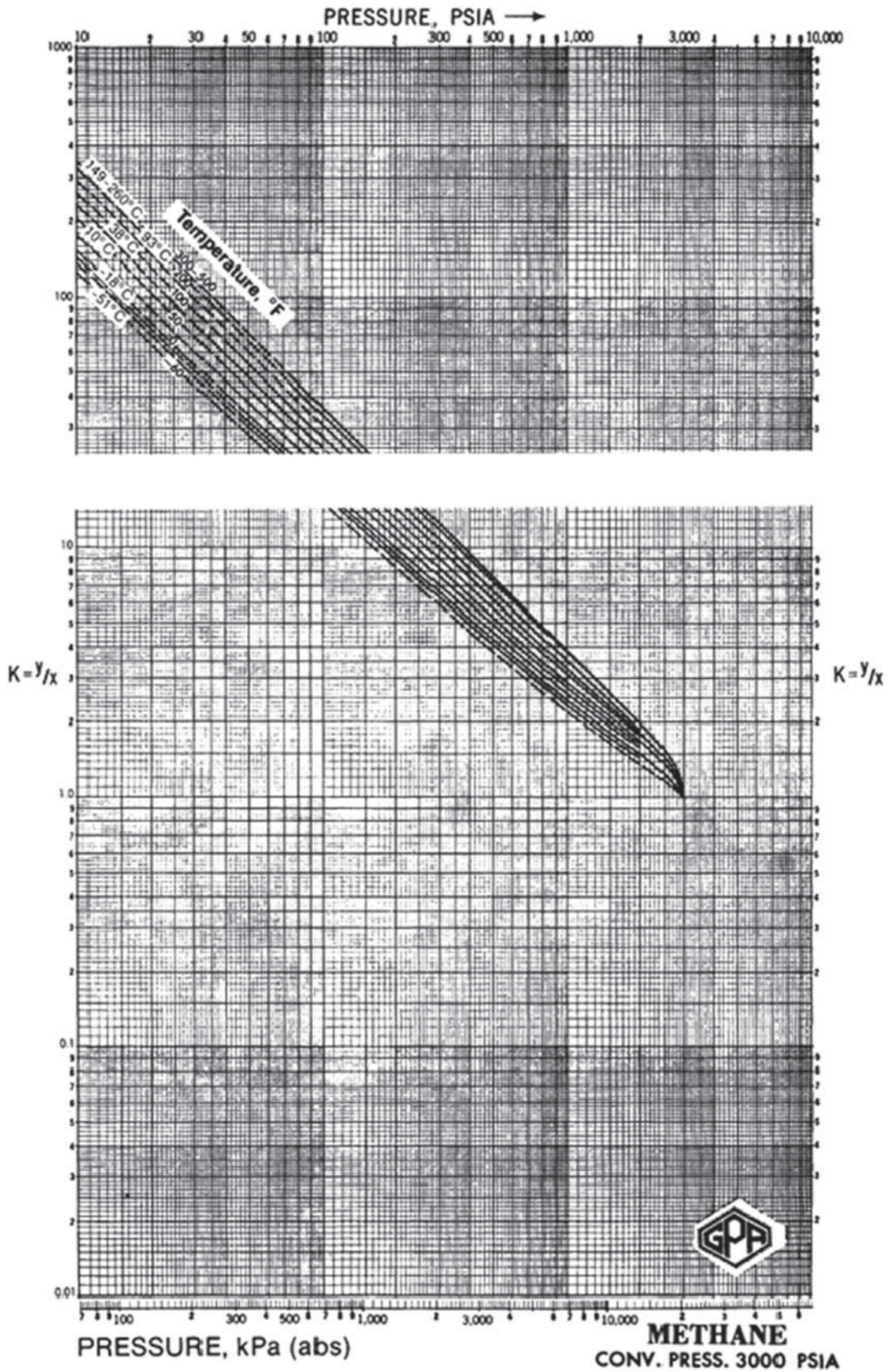


Figure 4.4b Pressure vs. K for Methane (CH₄) at convergence pressure of 3000 psia (20700kPa). Used by permission, Gas Processors Suppliers Association Data Book, 12th Ed., V. 1 and 2 (2004), Tulsa, Okla.

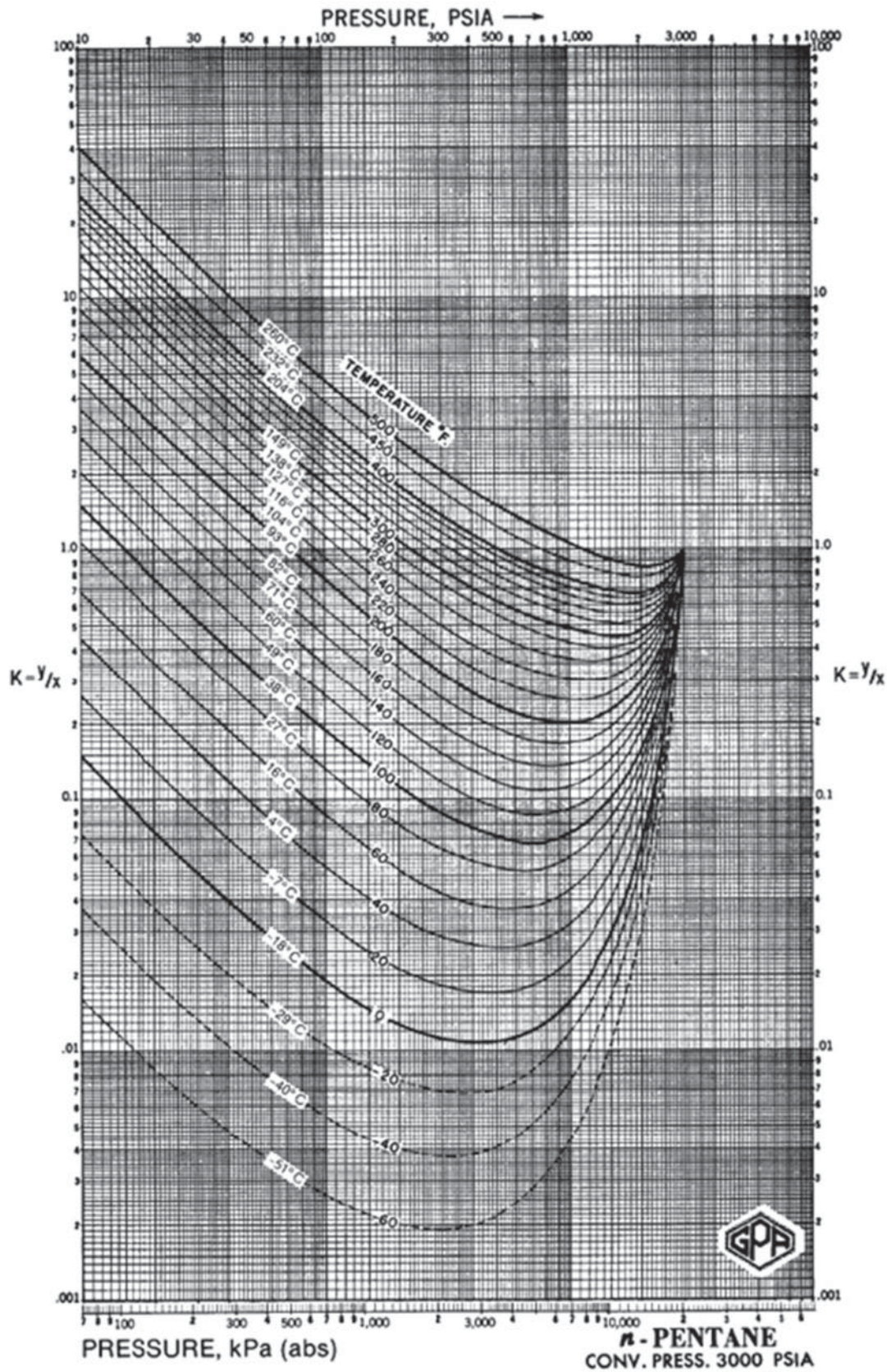


Figure 4.4c Pressure vs. K for n-Pentane (n-C₅H₁₂) at convergence pressure of 3000 psia (20700 kPa). Used by permission, Gas Processors Suppliers Association Data Book, 12th Ed., V. 1 and 2 (2004), Tulsa, Okla.

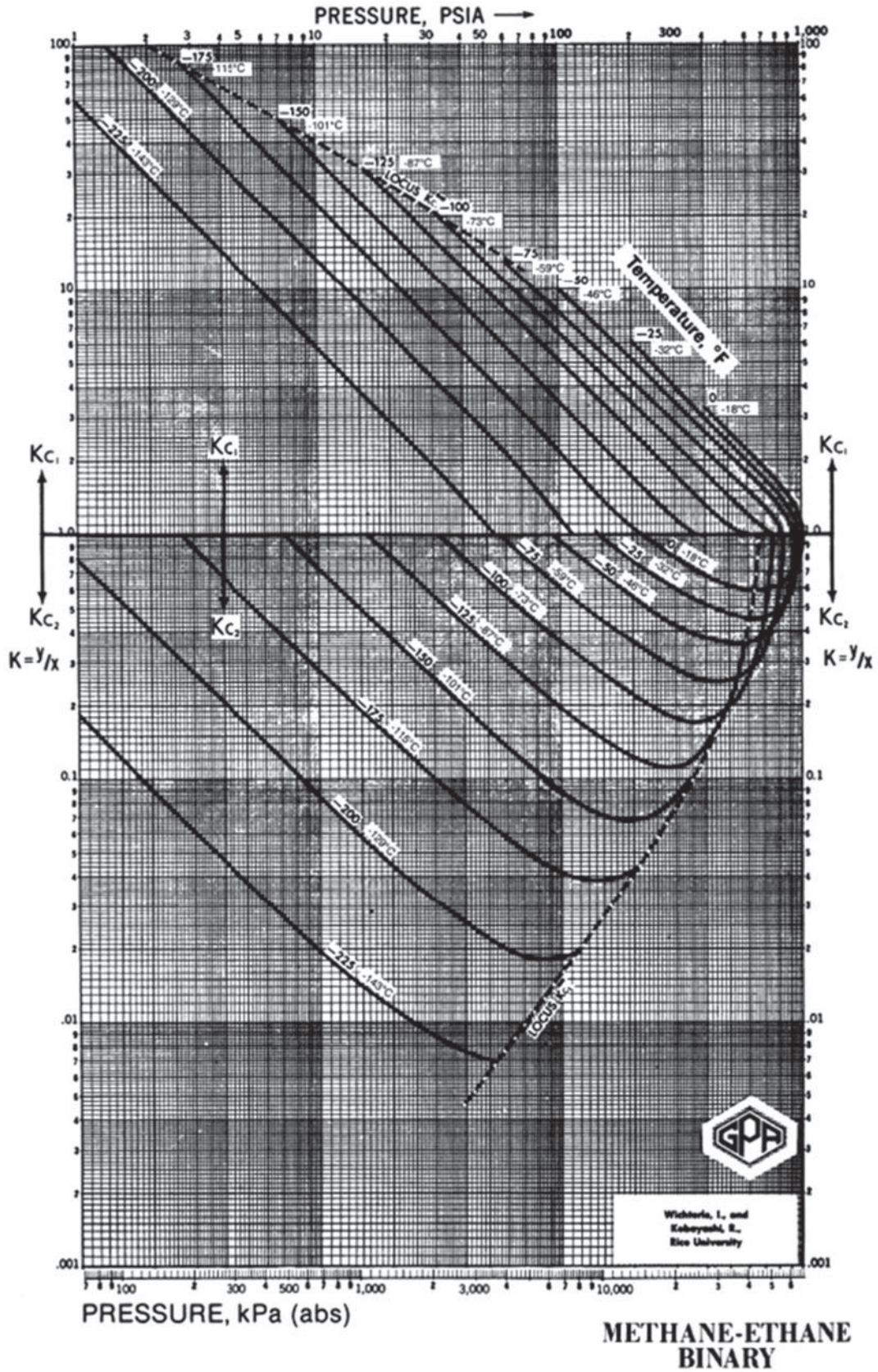


Figure 4.4d Pressure vs. K for Methane-Ethane binary. Used by permission, Gas Processors Suppliers Association Data Book, 12th Ed., V. 1 and 2, (2004), Tulsa, Okla.

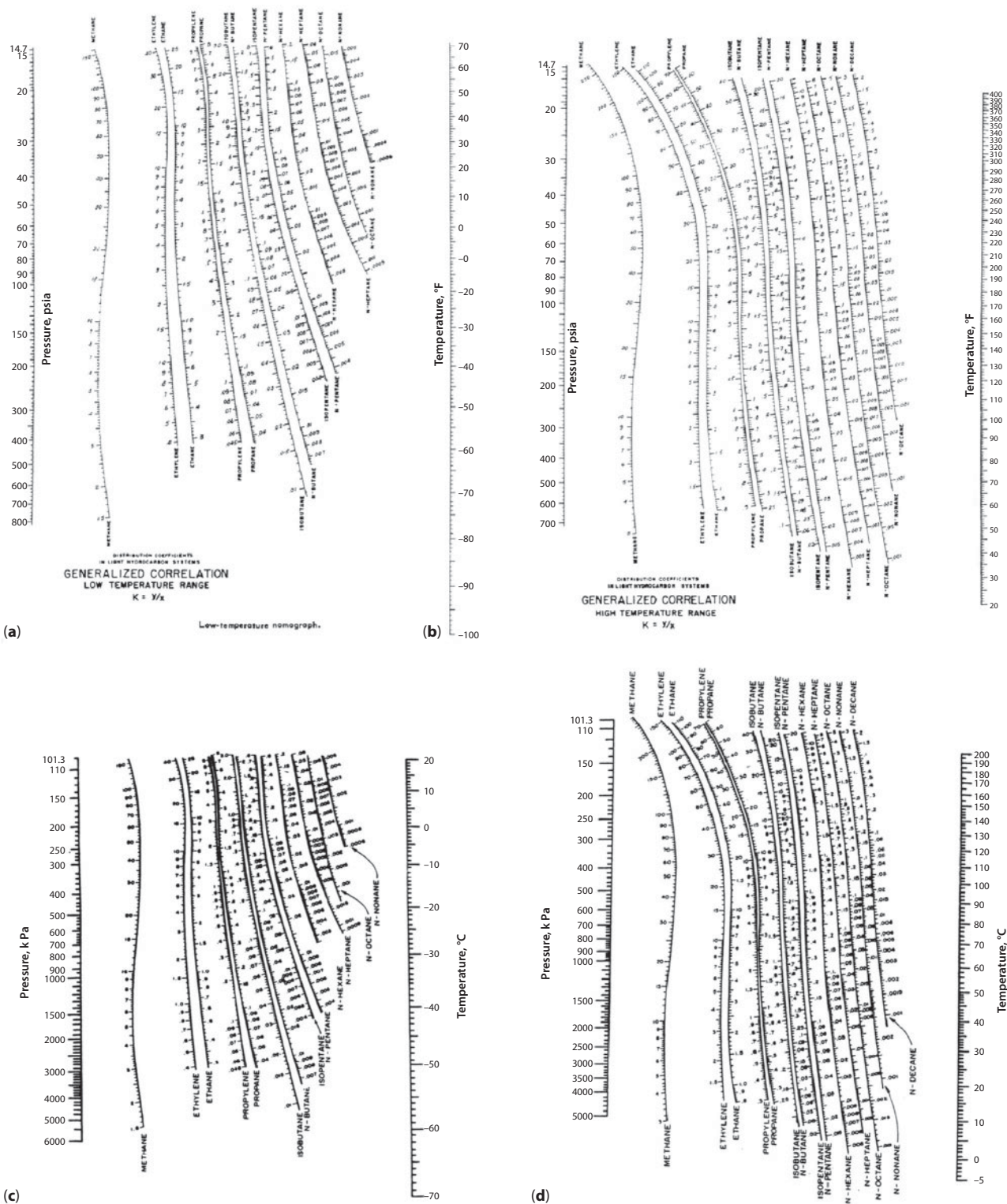


Figure 4.5 (a) DePriester Charts; K-Values of light hydrocarbon systems, generalized correlations, low-temperature range. Used by permission, DePriester, C. L., The American Institute of Chemical Engineers, Chemical Eng. Prog. Ser., 49, No. 7 (1953), all rights reserved. (b) DePriester Charts; K-Values of light hydrocarbon systems, generalized correlations, high-temperature range. Used by permission, DePriester, C. L., The American Institute of Chemical Engineers, Chemical Eng. Prog. Ser., 49, No. 7 (1953), all rights reserved. (c) Modified DePriester Chart (in S.I. units) at low temperature (D. B. Dadyburjor, Chem. Eng. Prog., 85, April 1978; copyright 1978, AIChE; reproduced by permission of the American Institute of Chemical Engineers). (d) Modified DePriester Chart (in S.I. units) at high temperature (D. B. Dadyburjor, Chem. Eng. Prog., 85, April 1978; copyright 1978, AIChE; reproduced by permission of the American Institute of Chemical Engineers).

Table 4.2 Constants for fit to K values using Equation 4.2.

Compound	a _{T1}	a _{T2}	a _{T6}	a _{p1}	a _{p2}	a _{p3}	Mean Error
Methane	-292,860	0	8.2445	-0.8951	59.8465	0	1.666
Ethylene	-600,076.875	0	7.90595	-0.84677	42.94594	0	2.65
Ethane	-687,248.25	0	7.90694	-0.88600	49.02654	0	1.95
Propylene	-923,484.6875	0	7.71725	-0.87871	47.67624		1.90
Propane	-970,688.5625	0	7.15059	-0.76984	0	6.90224	2.35
Isobutane	-1,166,846	0	7.72668	-0.92213	0	0	2.52
n-Butane	-1,280,557	0	7.94986	-0.96455	0	0	3.61
Isopentane	-1,481,583	0	7.58071	-0.93159	0	0	4.56
n-Pentane	-1,524,891	0	7.33129	-0.89143	0	0	4.30
n-Hexane	-1,778,901	0	6.96783	-0.84634	0	0	4.90
n-Heptane	-2,013,803	0	6.52914	-0.79543	0	0	6.34
n-Octane	0	-7646.81641	12.48547	-0.73152	0	0	7.58
n-Nonane	-2,551,040	0	5.69313	-0.67818	0	0	9.40
n-Decane	0	-9760.45703	13.80354	-0.71470	0	0	5.69

Note: T is in °R, and p is in psia.

(Source: McWilliams, M. L., "An Equation to Relate K-factors to Pressure and Temperature", Chem. Eng., 80 (25), 138, Oct 29, 1973).

a trial-and-error method is required. Perry and Green [5], and Smith and Van Ness [6] provide DePriester charts in alternative temperature and pressure units. McWilliams [7] has developed an equation to fit DePriester charts represented by

$$\ln K = a_{T1}/T^2 + a_{T2}/T + a_{T6} + a_{p1} \ln p + a_{p2}/p^2 + a_{p3}/p \quad (4.2)$$

where

$a_{T1}, a_{T2}, a_{T6}, a_{p1}, a_{p2}, a_{p3}$ = constants

K = equilibrium constant

p = absolute pressure, psia

T = absolute temperature (°R = °F + 460).

Equation 4.2 is valid from 365.7 °R (-70°C) to 851.7 °R (200°C) and from pressures from 14.69 psia (101.3 kPa) to 870.1 psia (6000 kPa). If K and p are known, Equation 4.2 can be solved for T. The relationship values can be easily incorporated into a computer program and can be determined more accurately than from the charts. Table 4.2 shows the constants for various components, and Equation 4.2 can be simplified

for all components except n-octane and n-decane. This is expressed by:

$$\ln K = a_{T1}/T^2 + a_{T6} + a_{p1} \ln p \quad (4.3)$$

Solving for T from Equation 4.2 gives

$$T = \left[\frac{a_{T1}}{\left(\ln K - a_{T6} - a_{p1} \ln p - \frac{a_{p2}}{p^2} - \frac{a_{p3}}{p} \right)} \right]^{0.5} \quad (4.4)$$

K values are used along with the stoichiometric equations which state that the sum of the mole fractions in liquid and vapor phases must equal to unity as defined by Equations 4.5 and 4.6 respectively.

For binary components,

$$x_A + x_B = 1 \quad (4.5)$$

and

$$y_A + y_B = 1 \quad (4.6)$$

For N number of components, Equations 4.5 and 4.6 can be expressed by

$$\sum_{i=1}^N x_i = 1.0, \quad \sum_{i=1}^N y_i = 1.0 \quad (4.7)$$

where

N = number of components.

If only one component is present, then $x = 1.0$ and $y = 1.0$, which implies that $K=y/x=1.0$. This is a simple way of determining the boiling point of a pure compound at any pressure. For example, to determine the boiling point of propane at $p = 200$ psia, a straight edge on $p = 200$ and $K = 1.0$ on the propane scale on Figure 4.5a. The temperature on the right side of the scale is $T = 100$ °F (560 °R) as the boiling point.

Using Equation 4.2 and values from Table 4.2 gives

$$\ln K = a_{T1}/T^2 + a_{T2}/T + a_{T6} + a_{p1} \ln p + a_{p2}/p^2 + a_{p3}/p \quad (4.2)$$

and

$$a_{T1} = -970,688.5625, \quad a_{T2} = 0, \quad a_{T6} = 7.15059,$$

$$a_{p1} = -0.76984, \quad a_{p2} = 0, \quad a_{p3} = 6.90224$$

$$\ln(1) = \frac{-970,688.5625}{T^2} + 0 + 7.15059 - 0.76984 \ln(200) + \frac{0}{200^2} + \frac{6.90224}{200}$$

$$T = 558.98 \text{ } ^\circ\text{R} \quad (98.98 \text{ } ^\circ\text{F})$$

This gives a 1.03% deviation from DePriester chart.

The K-factor charts represent pure components and pseudo binary systems of a light hydrocarbon plus a calculated pseudo heavy component in a mixture, when several components are present. For these more complex mixtures, it is necessary to determine the average molecular weight of the system on a methane-free basis, and then interpolate the K-value between the two binaries whose heavy component lies on either side of the pseudo-components. If nitrogen is at more than 3–5 mol%, the accuracy becomes poor. Reference 2, provides a more detailed explanation and a more complete set of charts.

4.2 Non-Ideal Systems

A system is non-ideal because of the interaction between molecules alters its behavior. The following groups all contribute to non-ideality; hydroxyl groups (-OH), ketone groups (-C=O), aldehyde groups (CHO), halogens (-Cl, -Br) and carboxylic acid groups

(-COOH). Systems of two or more hydrocarbon, chemical and water components may be non-ideal for a variety of reasons. Accurate experimental data are necessary to predict the distillation performance of these systems. The use of empirical relationships to predict the vapor pressure/concentration relationships at specific temperatures and pressures is inaccurate at best.

Prausnitz [8] presents a thorough analysis of the application of empirical techniques in the absence of experimental data. The basic question is to determine accurately the distribution of the respective system components between the liquid and gaseous phases. The concepts of fugacity and activity are fundamental to this. For a pure ideal gas, the fugacity is equal to the pressure, and for a component, i , in a mixture of ideal gases it is equal to its partial pressure $y_i P$, where P is the system pressure. As the system pressure approaches zero, the fugacity approaches ideal. For many systems, the deviations from unity are minor at system pressures less than 25 psig.

The ratio f/f_o is termed activity, a . [Note: This is not the activity coefficient.] The activity is an indication of how “active” a substance is relative to its standard state (not necessarily zero pressure), f_o . The standard state is the reference condition; most references are to constant temperature, with composition and pressure varying as required. Fugacity becomes a corrected pressure, representing a specific component’s deviation from ideal. The fugacity coefficient is:

$$\phi = \frac{f_i}{y_i P} \quad (4.8)$$

The Virial Equation of State for gases is generally:

$$Z = \frac{PV}{RT} = 1 + \frac{B}{V} + \frac{C}{V^2} + \frac{D}{V^3} + \dots \quad (4.9)$$

where

B, C, D, etc. = Virial coefficients, independent of pressure or density, and for pure components are functions of temperature only.

V = molar volume.

Z = compressibility factor.

Fugacities and activities can be determined using this concept. Other important equations of state, which can be related to fugacity and activity, have been developed by Redlich-Kwong [9] with Chueh [10], which develops the original Redlich-Kwong equation, and Palmer’s summary of activity coefficient methods [11].

Activity coefficients are equal to 1.0 for an ideal solution when the mole fraction is equal to the activity. The activity (a) of a component, i , at a specific temperature, pressure and composition is defined as the ratio of the fugacity of i at these conditions to the fugacity of i at the standard state [12].

$$a(T, P, x) = \frac{f_i(T, P, x)}{f_i(T^\circ, P^\circ, x^\circ)}, \text{ liquid phase} \quad (4.10)$$

(Zero superscript indicates a specific pressure and composition)

The activity coefficient r_i is

$$r_i = \frac{a_i}{x_i} = 1.0 \text{ for an ideal solution} \quad (4.11)$$

The ideal solution law, Henry's Law, also enters into the establishment of performance of ideal and non-ideal solutions.

The Redlich-Kister [13, 14] equations provide a good technique for representing liquid phase activity and classifying solutions.

The Gibbs-Duhem equation allows the determination of activity coefficients for one component from data for those of other components.

Wilson's [15] equation is quite accurate in predicting the vapor-liquid relationships and activity coefficients for miscible liquid systems. The results can be expanded to as many components in a multi-component system as necessary without any additional data requiring. This makes Renon's and Prausnitz's [16] techniques valuable for multi-component systems when applying computational solutions.

Renon's technique is applicable to partially miscible systems as well as those with complete miscibility. This is described in the reference above and in [11].

Other specific techniques are applicable in particular situations; they should often be investigated to make sure that they apply well to the system under consideration. They are often expressed in terms of the effective "K" for the components, i , of a system. Frequently used methods are those of Chao-Seader (CS), Peng-Robinson (PR), Renon, Redlich-Kwong, Soave Redlich-Kwong (SRK/RSK), Wilson. Table 4.3 lists the equations of state that are applied most widely.

The van-der-Waals equation (3) in Table 4.3 was the first successful approach in the formulation of an equation of state for a non-ideal gas. It is seldom used because its range of application is too narrow. The constants a and b are estimated from the critical

Table 4.3 Useful equations of state.

Name	Equation	Equation constants and functions
(1) ideal gas law	$P = \frac{RT}{V}$	None
(2) Generalized	$P = \frac{ZRT}{V}$	$Z = Z(P_r, T_r, Z_c \text{ or } \omega)$ as derived from data
(3) van-der-Waals	$P = \frac{RT}{(V-b)} - \frac{a}{V^2}$	a and b are species dependent constants and estimated from the critical temperature and pressure.
(4) Redlich-Kwong (R-K)	$P = \frac{RT}{V-b} - \frac{a}{V^2 + bV}$	$b = 0.08664 RT_c / P_c$ $a = 0.42748 R^2 T_c^{2.5} / P_c T^{0.5}$
(5) Soave-Redlich-Kwong (S-R-K or R-K-S)	$P = \frac{RT}{V-b} - \frac{a}{V^2 + bV}$	$b = 0.08664 RT_c / P_c$ $a = 0.42748 R^2 T_c^2 \left[1 + f_\omega (1 - T_r^{0.5}) \right]^2 / P_c$ $f_\omega = 0.48 + 1.574\omega - 0.176\omega^2$
(6) Peng-Robinson (P-R)	$P = \frac{RT}{V-b} - \frac{a}{V^2 + 2bV - b^2}$	$\left[\text{atm} \left(\frac{\text{cm}^3}{\text{gmol}} \right)^2 \right]$

Table 4.3.1 Constants for the van der Waals and Redlich-Kwong Equations.

	van der Waals		Redlich - Kwong	
	a*	b†	a††	b†
	$\left[\text{atm} \left(\frac{\text{cm}^3}{\text{g mol}} \right)^2 \right]$	$\left(\frac{\text{cm}^3}{\text{g mol}} \right)$	$\left[(\text{atm}) \left(K^{1/2} \right) \left(\frac{\text{cm}^3}{\text{g mol}} \right)^2 \right]$	$\left(\frac{\text{cm}^3}{\text{g mol}} \right)$
Air	1.33×10^6	36.6	15.65×10^6	25.3
Ammonia	4.19×10^6	37.3	85.00×10^6	25.7
Carbon dioxide	3.60×10^6	42.8	63.81×10^6	29.7
Ethane	5.50×10^6	65.1	97.42×10^6	45.1
Ethylene	4.48×10^6	57.2	76.92×10^6	39.9
Hydrogen	0.246×10^6	26.6	1.439×10^6	18.5
Methane	2.25×10^6	42.8	31.59×10^6	29.6
Nitrogen	1.347×10^6	38.6	15.34×10^6	26.8
Oxygen	1.36×10^6	31.9	17.12×10^6	22.1
Propane	9.24×10^6	90.7	180.5×10^6	62.7
Water vapor	5.48×10^6	30.6	140.9×10^6	21.1

* To convert to psia (ft³/lb mol)², multiply table value by 3.77×10^{-3}

† To convert to ft³/lb mol, multiply table value by 1.60×10^{-2}

†† To convert to psia (°R)^{1/2} (ft³/lb mol)², multiply table value by 5.067×10^{-3}
(Source: Himmelblau [43])

temperature T_c and pressure P_c . The generalized equation of state (2) given in Table 4.3 defines the compressibility factor Z , which is a function of reduced pressure P_r , ($P_r = P/P_c$) and reduced temperature T_r , ($T_r = T/T_c$). The critical compressibility factor Z_c , or the Acentric factor, w developed by Pitzer *et al.* [17] is determined from experimental P-V-T data. It accounts for differences in molecular shape, is determined from the vapor pressure curve and is defined as:

$$\omega = \left[-\log \left(\frac{P^s}{P_c} \right)_{T_r=0.7} \right] - 1.0 \quad (4.12)$$

Poling *et al.* [18] give extensive lists of values of w . The equation developed by Redlich and Kwong (4), in Table 4.3 is a considerable improvement over the van der Waals equation. Shah and Thodos [19] showed that the simple R-K equation gives a comparable accuracy with equations containing many empirical constants. The R-K equation can also approximate the liquid phase region. A cubic equation in V is obtained if the R-K equation is expanded to obtain a common denominator. Alternatively, (3) and (4) in Table 4.3 can be combined to eliminate V , and hence give the

compressibility factor Z form of the R-K equation as expressed by:

$$Z^3 - Z^2 + (A - B - B^2)Z - AB = 0 \quad (4.13)$$

where

$$A = \frac{aP}{R^2T^2} \quad (4.14)$$

$$B = \frac{bP}{RT} \quad (4.15)$$

Equation 4.13 which is cubic in Z can be solved analytically for three roots (e.g., see Appendix B).

4.3 Vapor Pressure

If the vapor and liquid of a pure component are in *equilibrium*, then the equilibrium pressure is known as the vapor pressure. Vapor pressure can be defined as the pressure that a pure component exerts at a given temperature when both liquid and vapor phases are present. It is a physical property of a pure chemical component, and depends only on temperature.

Table 4.4 Generalized Antoine constant functions for the SRK equation

$0.6 \leq T_r \leq 0.7$ $A' = 4.0434 + 2.1456f - 0.43477f^2 + 0.38481f^3 - 0.050479f^4$ $B' = 4.3755 + 1.2981f - 0.53208f^2 + 0.44506f^3 - 0.074005f^4$ $C' = 0.0708033 - 0.240584f + 0.0801510f^2 - 0.00990303f^3 - 0.000160472f^4$
$0.7 \leq T_r \leq 0.84$ $A' = 4.4401 + 2.2128f - 0.53518f^2 + 0.17368f^3 - 0.018512f^4$ $B' = 5.0075 + 1.2494f - 0.78155f^2 + 0.32010f^3 - 0.047601f^4$ $C' = 0.124652 - 0.273702f + 0.0750076f^2 - 0.0137818f^3 - 0.00145038f^4$
$0.84 \leq T_r \leq 1.0$ $A' = 4.8817 + 2.5164f - 0.53557f^2 + 0.09639f^3 - 0.012108f^4$ $B' = 5.8938 + 1.6311f - 0.91992f^2 + 0.24694f^3 - 0.034344f^4$ $C' = 0.206497 - 0.281653f + 0.0716095f^2 - 0.0174537f^3 - 0.00236311f^4$

A' , B' , C' = constants in generalized Antoine equation, f = acentric factor function, T_r = reduced temperature.

(Source: DeDoes, A. J, *et al.*, CEP, pp 39–44, Jan. 2007)

Vapor pressure is an essential parameter for the analysis of separation processes, such as flash separation, distillation or absorption. Various approaches such as tables and charts listing vapor pressure or boiling point among their physical properties are used for these analyses. These include steam tables, thermodynamic property tables and phase equilibrium diagrams such as pressure-enthalpy, pressure-volume or temperature-entropy diagrams.

DeDoes *et al.* [20] have provided some drawbacks of these approaches. They have also developed a generalized method, which combines pressure-volume-temperature (PVT) equations of state with thermodynamic criteria that are related to chemical potential or fugacity. The method uses three constants such as critical temperature, critical pressure and Acentric factor. Other phase properties, such as molar volume or density, residual enthalpy and residual entropy are also predicted, and generate mixture of compositions, K-values or relative volatilities when combined with appropriate mixing rules or a liquid solution model. The generalized method uses a three-constant Antoine vapor pressure relationship for any substance for which the critical temperature, critical pressure and Acentric factor are known. Vapor pressure predictions have been found to agree to within $\pm 0.1\%$ with those generated by an algorithm-based approach over a range of reduced temperatures between 0.60 to 1.00

for Soave-Redlich-Kwong (SRK) and between 0.7 and 1.00 for Peng-Robinson (PR) as shown in Table 4.4. Figure 4.6 shows Cox chart plots of vapor pressure for various substances, Figures 4.6a and Figure 4.6b show the vapor pressures for light hydrocarbons at a low-temperature range and at a high-temperature range respectively.

4.3.1 Vapor Pressure Determination using the Clausius-Clapeyron and the Antoine Equations

Standard chemical engineering texts [21, 22 and 23] provide equations to predict vapor-pressure of compounds, and a commonly given equation for the vapor pressure is expressed by:

$$\log_{10} P_v = A + \frac{B}{T} + C \log_{10} T + DT + ET^2 \quad (4.16)$$

where

P_v is the vapor pressure in mm Hg, and A, B, C, D and E are constants. Sometimes, it is useful to estimate the saturated vapor pressure from the Clausius-Clapeyron equation as

$$\frac{dP^{vap}}{dT} = \frac{P^{vap} \Delta H_{vap}}{RT^2} \quad \text{or} \quad \frac{d \ln P^{vap}}{dT} = \frac{\Delta H_{vap}}{RT^2} \quad (4.17)$$

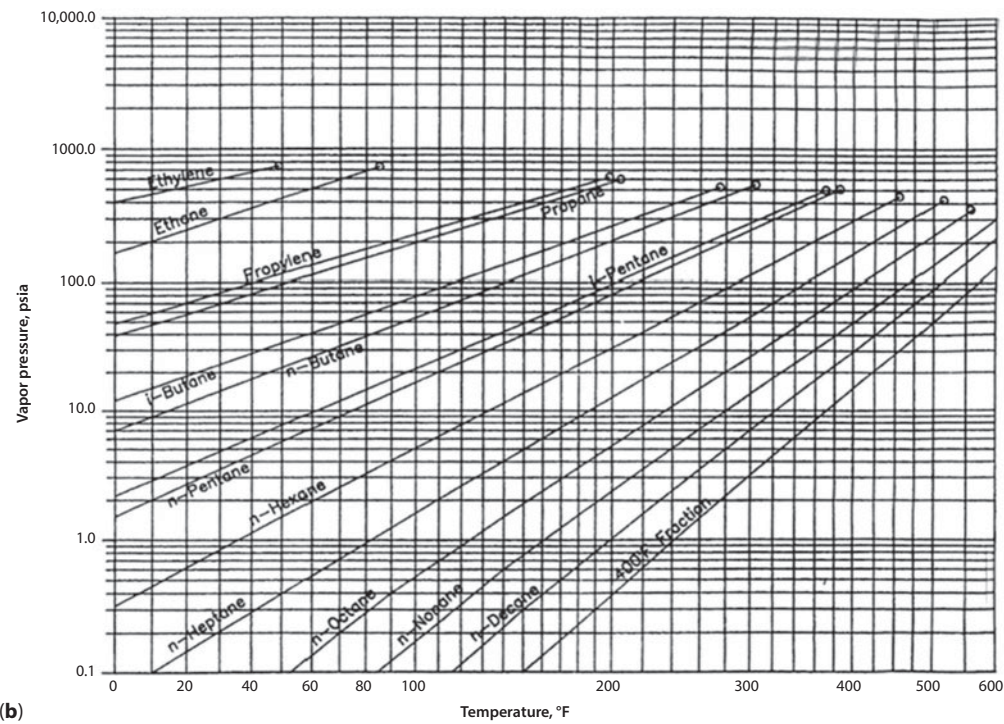
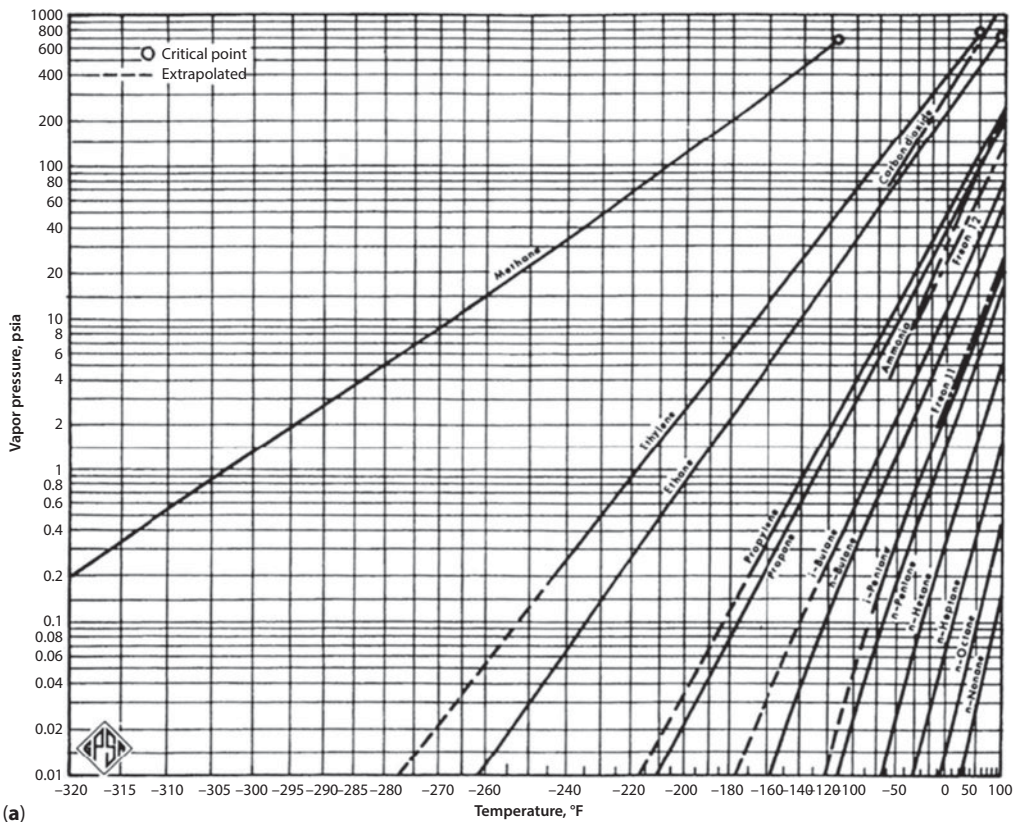


Figure 4.6 Cox chart vapor pressure plots. (Source: A. S. Foust *et al.*, Principles of Unit Operations, Wiley New York, p550, 1960). (a) Low-temperature vapor for light hydrocarbons. Used by permission, Gas Processors Suppliers Association Data Book, 12th Ed., V. 1 and 2 (2004), Tulsa, Okla. (b) High-temperature vapor for light hydrocarbons. Used by permission, Gas Processors Suppliers Association Data Book, 12th Ed., V. 1 and 2 (2004), Tulsa, Okla.

and

$$\ln \left(\frac{P^{vap}(T_2)}{P^{vap}(T_1)} \right) = \int_{T_1}^{T_2} \frac{\Delta H_{vap}}{RT^2} dT \quad (4.18)$$

where ΔH_{vap} is the molar latent heat of vaporization and T is the absolute temperature. $\Delta H_{vap} = H^V - H^L$ is a function of temperature; but if it assumed to be independent of temperature, Equation 4.18 can be integrated to give:

$$\ln \left(\frac{P^{vap}(T_2)}{P^{vap}(T_1)} \right) = -\frac{\Delta H_{vap}}{R} \left(\frac{1}{T_2} - \frac{1}{T_1} \right) \quad (4.19)$$

Equation 4.19 has been found to be fairly accurate for correlating the temperature dependence of the vapor pressure of liquids over limited temperature ranges.

Note: $\ln P^{vap}$ should be a linear function of $1/T$, where T is the absolute temperature with the lower limit of integration as the normal boiling conditions, i.e., $T_1 = T_{nb}$ at $P^{vap}(T_1) = P_{atm}$ where P_{atm} is the atmospheric pressure, ΔH_{vap} and R are in a consistent set of units. One can obtain an estimate of the temperature variation of the heat of vaporization by noting that the integration of Equation 4.19 can be carried out as an indefinite rather than definite integral, which gives:

$$\ln P^{vap}(T) = -\frac{\Delta H_{vap}}{RT} + C \quad (4.20)$$

where C is a constant. A plot of $\ln P^{vap}$ versus $1/T$, should give a straight line with a slope equal to $-\Delta H_{vap}/R$, if the heat of vaporization is independent of

temperature, and a curve if $-\Delta H_{vap}/R$ varies with temperature. Equation 4.20 can be rewritten as:

$$\ln P^{vap}(T) = A - \frac{B}{T} \quad (4.21)$$

with $B = -\Delta H_{vap}/R$, and it is reasonably accurate for estimating the temperature dependence of the vapor pressure over small temperature ranges.

Correspondingly, the Antoine equation can be expressed by:

$$\ln P^* = A - \frac{B}{T+C} \quad (4.22)$$

or

$$\log P^* = \frac{\ln P^*}{\ln 10} = A - \frac{B}{T+C} \quad (4.23)$$

where A , B and C are dimensional constants, P^* is the vapor pressure and T is the temperature. Equation 4.23 is used to correlate vapor pressure accurately over the range from 1 to 200 kPa. The generalized Antoine equation is expressed as:

$$\ln P_r^* = A' - \frac{B'}{T_r + C'} \quad (4.24)$$

where A' , B' and C' are constants that depend upon the Acentric factor. Tables 4.4 and 4.5 represent the generalized Antoine constants derived from the vapor pressure predictions of the RSK equation and the PR equation respectively. Table 4.6 shows the transformation required to convert values of A' , B' and C' to Antoine's

Table 4.5 Generalized Antoine constant functions for the PR equation.

$0.7 \leq T_r \leq 0.84$ $A' = 4.8512 + 2.3617f - 0.45894f^2 - 0.070461f^3 + 0.10809f^4$ $B' = 5.5675 + 1.3213f - 0.80186f^2 + 0.11081f^3 + 0.087503f^4$ $C' = 0.145395 - 0.287367f + 0.0815004f^2 - 0.0253619f^3 - 0.00813261f^4$
$0.84 \leq T_r \leq 1.0$ $A' = 5.3988 + 3.0095f - 0.68621f^2 + 0.10190f^3 - 0.0027322f^4$ $B' = 6.7141 + 2.3263f - 1.3630f^2 + 0.35003f^3 - 0.035704f^4$ $C' = 0.243432 - 0.260581f + 0.0448442f^2 - 0.00718139f^3 - 0.00122297f^4$

A' , B' , C' = constants in generalized Antoine equation, f = Acentric factor function, T_r = reduced temperature.

(Source: DeDoe, A. J, *et al.*, CER, pp 39–44, Jan. 2007)

Table 4.6 Transforming Antoine constants A', B' and C' from Table 4.4 to dimensional constants A, B and C for use in Equation 4.22.

$B = B' + \ln P_c$	The units of P_c must be absolute pressure Vapor pressure P^* in Equation 4.22 will have the same units as P_c
$B = B'T_c$	The units of T_c must be absolute temperature in K or °R
$C = C'T_c$	Temperature T in Equation 4.22 will have the same as T_c
$C = C'T_c + 273.15$	Temperature T in Equation 4.22 in °C and T_c in K
$C = C'T_c + 459.56$	Temperature T in Equation 4.22 in °F and T_c in oR

(Source: DeDoes, A. J, *et al.*, CEP, pp 39–44, Jan. 2007)

constants of A, B and C for use with various temperature and pressure units in Equation 4.21. An Excel spreadsheet program (Example 4-1.xlsx) has been developed to determine the vapor pressure, molar volumes, and fugacity coefficients from Soave-Redlich-Kwong (SRK) equation of state. The spreadsheet also compares the vapor pressure using the generalized Antoine equation with the polynomial and the calculated vapor pressure from SRK equation. Another spreadsheet program (Example 4-1a.xlsx) has been developed to compare the vapor pressure of components using the Antoine Equation 4.22 and coefficients in Table 4.7 with the Clausius-Clapeyron Equation 4.19 over a range of temperatures. The saturated vapor pressure curves of acetone that were predicted by Equations 4.19 and 4.22 are shown in Figure 4.7. The parameters are taken from Reid, *et al.* [21] and have the values $T_{nb} = 329.4$ K, $\Delta H_{vap} = 6960$ cal/gmol $R = 1.98721$ cal/gmol K. At pressures <10 atm., the Clausius-Clapeyron equation reproduces the experimental data very closely and would be appropriate for use in vapor-liquid equilibrium (VLE) calculations. At high pressure, the predictions are not so good, and by comparison, the Antoine coefficients can only be obtained by regression of experimental vapor pressure data. If the constant ΔH_{vap} in the Clausius-Clapeyron equation is treated as an adjustable parameter and fitted to the experimental vapor pressure data, a value of 7175 cal/gmol produces a curve that fits the data accurately as the Antoine equation [24].

Example 4-1: Soave-Redlich-Kwong Prediction of Vapor Pressure

For n-pentane, $T_c = 469.76$ K, $P_c = 33.7$ bar, $\omega = 0.252$. Use these data to verify that the SRK equation predicts a vapor pressure of 1.05 bar at 309.2K. Also, verify

these data with the generalized Antoine equation. $R = 83.14$ cm³-bar/mol-K.

Solution

The Excel spreadsheet, Example 4-1.xlsx, has been developed to calculate the molar volumes of liquid and vapor of any component such as pentane, its fugacity coefficient in liquid and vapor phases, and the vapor pressure of n-pentane using the SRK, the generalized Antoine equation and a polynomial equation. The percentage deviation in the value of the vapor pressure between the SRK equation and the generalized Antoine's equation can be calculated. Equation 4.24 depends on the reduced temperature and Acentric factor, and Table 4.6 provides the constants A', B' and C' for SRK at a range of reduced temperature, T_r ($0.64 \leq T_r \leq 1.0$). The spreadsheet calculates the vapor pressure of SRK equation by using a Goal seek/Solver optimization tool in the Excel spreadsheet. The SRK (Equation 5) in Table 4.3 is:

$$P = \frac{RT}{V - b_{SRK}} - \frac{a_{SRK}(T)}{V(V + b_{SRK})} \quad (4.25)$$

where

$$a_{SRK}(T) = 0.42748R^2T_c^2 \left[1 + f_\omega (1 - T_r^{0.5}) \right]^2 / P_c \quad (4.26)$$

$$b_{SRK} = 0.08664RT_c / P_c \quad (4.27)$$

$$f_\omega = 0.48 + 1.574\omega - 0.176\omega^2 \quad (4.28)$$

The constant parameter a_{SRK} in Equation 4.26 is calculated from Equation 4.28, with known and calculated values of the critical temperature, reduced temperature, critical pressure and the Universal gas

Table 4.7 Antoine coefficients for selected substances

Substance	A	B	C	Temperature range, °C
Acetone	7.63132	1566.69	273.419	57 to 205
Water	8.01767	1715.70	234.268	100 to 265
Benzene	6.87987	1196.76	219.161	8 to 80
Toluene	6.95087	1342.31	219.187	-27 to 111
Ethylene glycol	8.09083	2088.936	203.454	50 to 150
Hexane	6.91058	1189.64	226.280	-30 to 170
p-Xylene	6.99053	1453.430	215.310	27 to 166
Ethanol	8.11220	1592.864	226.184	20 to 93
Acetic acid	8.02100	1936.010	258.451	18 to 118
Acetaldehyde	7.20812	1099.810	233.945	-82 to 20
Methanol	8.08097	1582.271	239.726	15 to 84
Methyl ethyl ketone	7.06356	1261.340	221.969	43 to 88
Chloroform	6.95465	1170.966	226.232	-10 to 60
Ethylenediamine	8.09831	1893.720	245.676	11 to 117
4-Methyl-2-pentanol	8.46706	2174.869	257.780	25 to 133
Dichloromethane	7.08030	1138.910	231.450	-44 to 59
1,3-Butadiene	6.85364	933.586	239.511	-75 to -2
Styrene	7.50233	1819.810	248.662	-7 to 145
Ethyl acetate	7.10179	1244.950	217.881	16 to 76
Vinylacetylene	7.02515	999.110	235.817	-93 to 5
Acetic anhydride	7.69301	1781.29	230.395	2 to 140
Dichlorosilane [§]	7.18600	1224.50	273.16	-45 to 121
Trichlorosilane	6.95524	1102.900	238.865	-81 to 32
Silicon tetrachloride	7.02404	1212.890	235.910	-63 to 57
Hydrogen chloride [†]	7.44899	868.358	274.904	-85 to 36

[§] Bawa, M. S., Texas Instruments (1988).

[†] Ohe, S., Computer-Aided Data Book of Vapor Pressure, Data Book Publishing Company, Tokyo, Japan (1976).

(Source: Vapor-Liquid Equilibrium Data Collection of the DECHEMA Chemistry Data Series, except where noted. The form of the equation is $\log_{10} P^{\text{vap}} = A - B/(T+C)$ with pressure in mmHg and temperature in °C.

constant; the constant parameter b_{SRK} is calculated from Equation 4.27. Equation 4.25 is rearranged in terms of the molar volume as a cubic equation and is solved for liquid and vapor molar volumes using the developed Excel spreadsheet (Example 4.1.xlsx). The SRK equation is now expressed in terms of the molar volume as:

$$f(V) = V^3 - \frac{RT}{P}V^2 + \left(\frac{a_{\text{SRK}} - b_{\text{SRK}} - Pb_{\text{SRK}}^2}{P} \right)V - \frac{a_{\text{SRK}}b_{\text{SRK}}}{P} = 0 \quad (4.29)$$

Using the calculated vapor pressure from the generalized Antoine Equation 4.24, the molar volumes (three real roots) are determined. The liquid molar volume and the vapor molar volume (i.e., the lowest and

highest values) are then chosen from these three roots, and are used to determine the fugacity of the liquid and vapor phases from the following equations [20]:

$$Z = \frac{PV}{RT} \quad (4.30)$$

$$h = \frac{b_{\text{SRK}}}{V} \quad (4.31)$$

$$\ln \phi = Z - 1 - \ln Z - \ln(1-h) - \frac{a_{\text{SRK}}}{b_{\text{SRK}}RT} \ln(1+h) \quad (4.32)$$

Equation 4.25 is rearranged in the form

$$f(P) = P - \frac{RT}{V - b_{\text{SRK}}} + \frac{a_{\text{SRK}}(T)}{V(V + b_{\text{SRK}})} = 0 \quad (4.33)$$

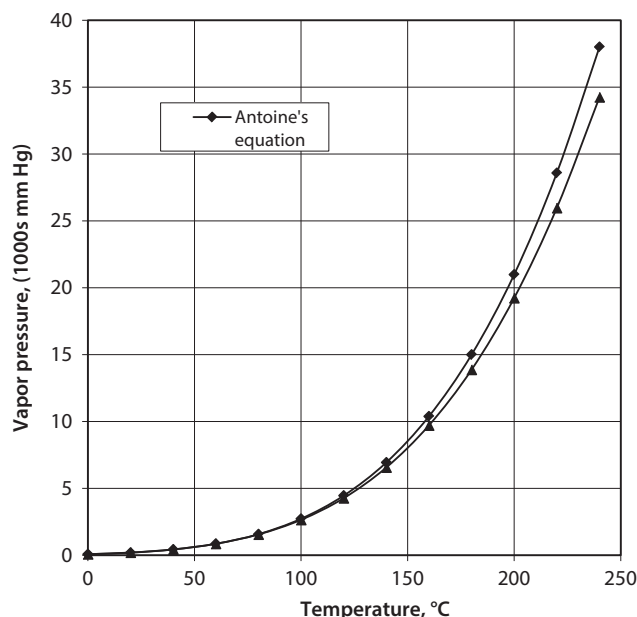


Figure 4.7 Vapor pressure of Acetone vs. temperature.

Equation 4.33 in the Excel spreadsheet (Example 4-1.xlsx) is set to zero (cell B44) and is optimized by changing cell G37 using Solver or Go-Seek optimizer in the spreadsheet. This is carried out for known value of the calculated molar volume V , by changing the value of the vapor pressure within the cell. When the final value of Equation 4.33 becomes 0, then the computed value of P (cell G37) gives the required vapor pressure. Since the calculated fugacity coefficients for both liquid and vapor are equal, the vapor pressure as calculated from SRK equation is the estimated known vapor pressure at the specified temperature. In this example, the vapor pressure of *n*-pentane at 309.2 K is 1.05 bar. Figures 4.8a-c show snapshots of the Excel spreadsheet for calculating the vapor pressure using the SRK model.

Example 4-2: Use of the Clausius-Clapeyron Equation to Predict Heat of Vaporization

The vapor pressure of liquid 2, 2, 4 trimethyl pentane at various temperatures is given below. Estimate the heat of vaporization of this compound at 25 °C.

Vapor pressure (kPa)	0.667	1.333	2.666	5.333	8.000	13.33	26.66	53.33	101.32
Temperature (°C)	-15.0	-4.3	7.5	20.7	29.1	40.7	58.1	78.0	99.2

Solution

The Excel spreadsheet Example 4-2.xlsx has been developed to estimate the heat of vaporization and Figure 4.9 shows the trend line from the spreadsheet indicating that ΔH_{vap} is constant over the whole range of temperature. The value of the slope from the trend line is:

$$\frac{\Delta H_{\text{vap}}}{R} = 4.2289 \times 10^3$$

$R = 8.314 \text{ J/mol K}$ and the estimated $\Delta H_{\text{vap}} = 8.314 \times 4.2289 \times 10 \text{ J/mol}$

The calculated heat of vaporization, $\Delta H_{\text{vap}} = 35.16 \text{ kJ/mol}$.

4.4 Viscosity

The viscosity of oil is its internal resistance to flow and a measure of its usefulness as a lubricating substance. Crude oil viscosities are usually measured for calculating the pressure drop in pipelines and for deriving the specifications of equipment such as exchangers and pumps. The Saybolt Universal viscosity test (ASTM D88) is the most common method used by refiners. This measures the time taken (in seconds) for a sample of 60 cc of oil to flow from a container through a calibrated orifice at a prescribed temperature. The entire apparatus for viscosity measurement contains a constant temperature bath and a precalibrated capillary viscometer such as Cannon-Fenske, Ubbelohde, Fitzsimmons, Zeitfuchs and the efflux time of the liquid from the viscometer give the relative viscosity measurement. The calibration liquid for the viscometer is a standard solution of known viscosity, and essentially all practical viscosity measurements are relative measurements using a standard, rather than absolute measurements. The usual test temperatures are 100 and 210 °F (37.8 and 99.2 °C).

Saybolt viscosities are referred to as seconds. The Saybolt Furol viscosity test (ASTM D88) is a similar test for heavy fuel oils and uses a large orifice. Saybolt Furol viscosities are reported at 122 and 210 °F (50.3 and 99.2 °C). Figure 4.10 shows snapshot of a plot of liquid volume% vs. viscosity of a petroleum blend.

4.4.1 Conversion to Saybolt Universal Viscosity

Kinematic viscosity in centistokes (mm^2/s) can be converted to Saybolt universal viscosity in Saybolt universal seconds (SUS) units at the same temperature by

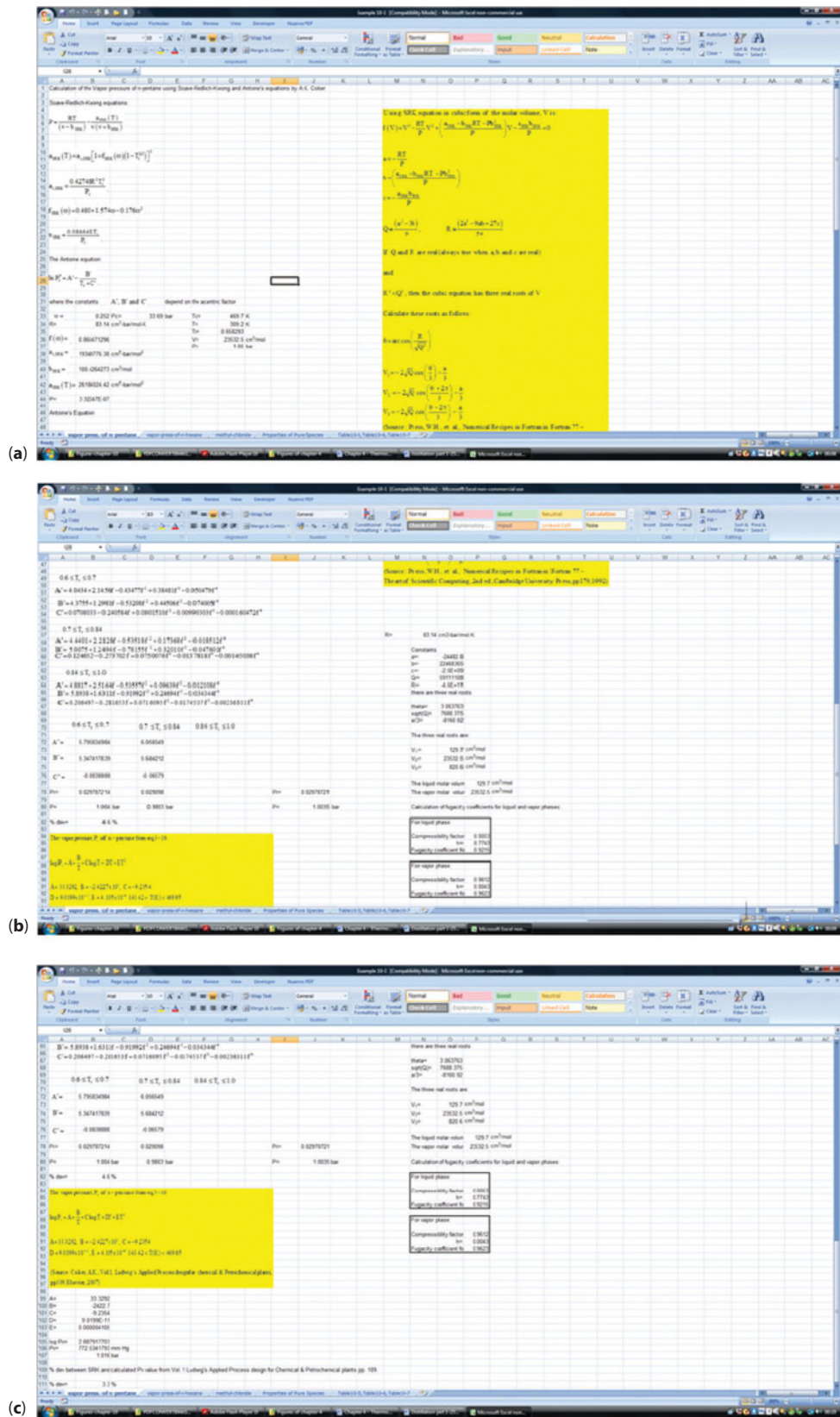


Figure 4.8 (a) Snapshot of the Excel spreadsheet for calculating the vapor-pressure using SRK method and Antoine's Equation (Example 4.1). (b) Snapshot of the Excel spreadsheet for calculating the vapor-pressure using SRK method and Antoine's Equation (Example 4.1). (c) Snapshot of the Excel spreadsheet for calculating the vapor-pressure using SRK method and Antoine's Equation (Example 4.1).

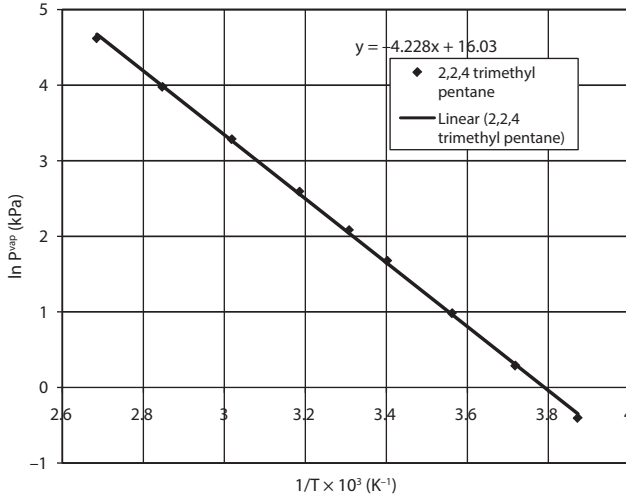


Figure 4.9 A plot of $\ln P^{vap}$ versus $1/T$ of 2,2,4 trimethyl pentane

API data book [25] procedure or using ASTM conversion tables [26].

$$SUS = 4.6324cSt$$

$$+ \frac{[1.0 + 0.03264cSt]}{[3930.2 + 262.7cSt + 23.97cSt^2 + 1.646cSt^3] \times 10^{-5}} \quad (4.34)$$

where

SUS = Saybolt universal viscosity in Saybolt universal seconds units at 37.8 °C

cSt = kinematic viscosity, centistokes (mm²/s).

SUS viscosity at 37.8 °C can be converted to SUS viscosity at another temperature by the following relationship:

$$SUS_t = [1 + 0.000110 \times (t - 37.8)] \times SUS \quad (4.35)$$

where

SUS = SUS viscosity at 37.8 °C

SUS_t = SUS viscosity at the required temperature

t = temperature at which SUS viscosity is required, °C.

4.4.2 Conversion to Saybolt Furol Viscosity

Kinematic viscosity in centistokes (mm²/s) at 50 and 98.9 °C can be converted to Saybolt Furol viscosity in Saybolt Furol seconds (SFS) units at the same temperature by API data books [27]:

$$SFS_{50} = (0.4717)(VIS_{50}) + \frac{13.924}{(VIS_{50})^2 - 72.59VIS_{50} + 6.816} \quad (4.36)$$

$$SFS_{98.9} = (0.4792)(VIS_{98.9}) + \frac{5.610}{(VIS_{98.9})^2 + 2.130} \quad (4.37)$$

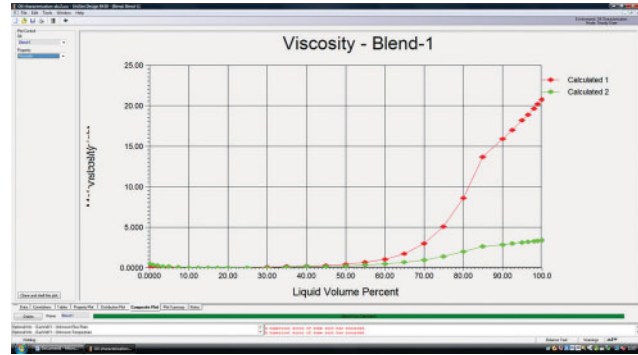


Figure 4.10 Snapshot of liquid volume (%) vs. viscosity of petroleum blend (Courtesy of Honeywell UniSim software), Honeywell (R) and UniSim (R) are registered trademarks of Honeywell International Inc.

where

SFS₅₀ = Saybolt Furol viscosity at 50 °C, Saybolt Furol seconds.

VIS₅₀ = kinematic viscosity at 50 °C, centistokes (mm²/s)

SFS_{98.9} = Saybolt Furol viscosity at 98.9 °C, Saybolt Furol seconds.

VIS_{98.9} = kinematic viscosity at 98.9 °C, centistokes (mm²/s).

4.4.3 Equivalents of Kinematic (cSt), Saybolt Universal (SUS), and Dynamic viscosity

Saybolt Universal Seconds

$$= \text{Centistokes} \times 4.6347 \text{ for } \nu(cSt) > 50 \quad (4.38)$$

$$\text{Saybolt Furol Seconds} = \text{Centistokes} \times 0.4717 \quad (4.39)$$

or

$$\text{Kinematic viscosity}(cSt) = \frac{\text{Dynamic viscosity, } \mu(cP)}{SpGr} \quad (4.40)$$

where the specific gravity is the ratio of the density of the fluid referenced to water. The specific gravity of water being 1.0 at 60 °F.

$$\text{Kinematic viscosity}(cSt) = 10^3 \times \frac{\text{Dynamic viscosity, } \mu(cP)}{\text{Density, } \rho \left(\frac{kg}{m^3} \right)} \quad (4.41)$$

The Saybolt universal viscosity equivalent to a given kinematic viscosity varies slightly with the temperature at which the measurement is made, because the temperature of the calibrated receiving flask used in the Saybolt method is not the same as that of the oil. Figure 4.11 shows viscosity vs. temperature chart of Kuwait crude oil and crude fractions and Table 4.8 shows how kinematic viscosities are converted from 2–70 centistokes at 100 °F (38 °C) and 210 °F (99 °C) to equivalent saybolt universal viscosities in seconds.

$$1\text{cSt} = 10^{-6} \text{ m}^2/\text{s}.$$

Appropriate multipliers are listed to convert kinematic viscosities over 70 centistokes (cSt). For kinematic viscosity determined at any other temperature the equivalent Saybolt universal value is calculated by use of the Saybolt equivalent at 100° F (38° C) and a multiplier that varies with the temperature:

$$\text{Saybolt Universal viscosity, sec at } 100^\circ \text{ F} \text{ (} 38^\circ \text{ C)} = \text{cSt} \times 4.635$$

$$\text{Saybolt Universal viscosity, sec at } 210^\circ \text{ F} \text{ (} 99^\circ \text{ C)} = \text{cSt} \times 4.667$$

Table 4.9 shows the kinematic viscosity of some crude oils.

Figure 4.12 shows plots of viscosity of hydrocarbon vapors.

$$1 \text{ cP} = 10^{-3} \text{ N.s/m}^2$$

Example 4-3

- Estimate the Saybolt furol viscosity of oil at 50 °C, if the kinematic viscosity at 50 °C is 3000 centistokes.
- Estimate the Saybolt furol viscosity of oil at 98.9 °C, if the kinematic viscosity at 98.9 °C is 120 centistokes.

Solution (a)

Saybolt furol viscosity at 50 °C is calculated from kinematic viscosity by equation 4.36 as follows:

$$\begin{aligned} SFS_{50} &= (0.4717)(VIS_{50}) + \frac{13.924}{(VIS_{50})^2 - 72.59VIS_{50} + 6.816} \\ &= (0.4717)(3000) + \frac{13.924}{(3000)^2 - 72.59(3000) + 6.816} \\ &= 1415.1 \text{ sec.} \end{aligned} \quad (4.36)$$

Solution (b)

The Saybolt furol viscosity at 98.9 °C is calculated from kinematic viscosity by equation 4.37

$$\begin{aligned} SFS_{98.9} &= (0.4792)(VIS_{98.9}) + \frac{5.610}{(VIS_{98.9})^2 + 2.130} \\ &= (0.4792)(120) + \frac{5.610}{(120)^2 + 2.130} \\ &= 57.5 \text{ sec.} \end{aligned} \quad (4.37)$$

4.4.4 Viscosity of Liquid Hydrocarbons

The following equations are a good quick method that is reasonably close for most hydrocarbons for API gravity basis. The term API refers to the American Petroleum Institute gravity method. These viscosity equations are derived using numerous actual sample points. These sample points ranged from 10 to 40 °API crude oils and products.

Viscosity, cP for 10 °API oil:	$\mu = \exp(18.919 - 0.1322T + 2.431e^{-0.4T^2})$ (4.42)
Viscosity, cP for 20 °API oil:	$\mu = \exp(9.21 - 0.0469T + 3.167e^{-0.5T^2})$ (4.43)
Viscosity, cP for 30 °API oil:	$\mu = \exp(5.804 - 0.02983T + 1.2485e^{-0.5T^2})$ (4.44)
Viscosity, cP for 40 °API oil:	$\mu = \exp(3.518 - 0.01591T + 1.734e^{-0.5T^2})$ (4.45)

where

μ = viscosity, cP

T = Temperature, °F

\exp = constant of natural log base, 2.7183, which is raised to the power in the parentheses.

Equations 4.42 to 4.45 are in agreement with Sec. 9 of Maxwell's Data Book on Hydrocarbons [28]. Temperature range is from 50–300 °F; if outside of this range, use the American Standard Testing Materials (ASTM) Standard Viscosity – Temperature Charts for Liquid Petroleum Products (ASTM D-341 [29]). The values derived by Equations (4.40) to (4.43) are found to be within a small percentage of error by the ASTM D-341 method.

Pedersen *et al.* [30] developed the following expressions to calculate the liquid viscosity of petroleum fractions at atmospheric pressure and at temperatures of 100 °F (37.8 °C) and 210 °F (98.9 °C):

$$\begin{aligned} \log \mu_{100} &= 4.39371 - 1.94733K + 0.127690K^2 + 3.2629 \times 10^{-4} (API)^2 \\ &\quad - 1.18246 \times 10^{-2} K(API) \\ &\quad + \frac{0.17161K^2 + 10.9943(API) + 9.50663 \times 10^{-2} K(API)^2 - 0.860218K(API)}{API + 50.3642 - 4.78231K} \end{aligned} \quad (4.46)$$

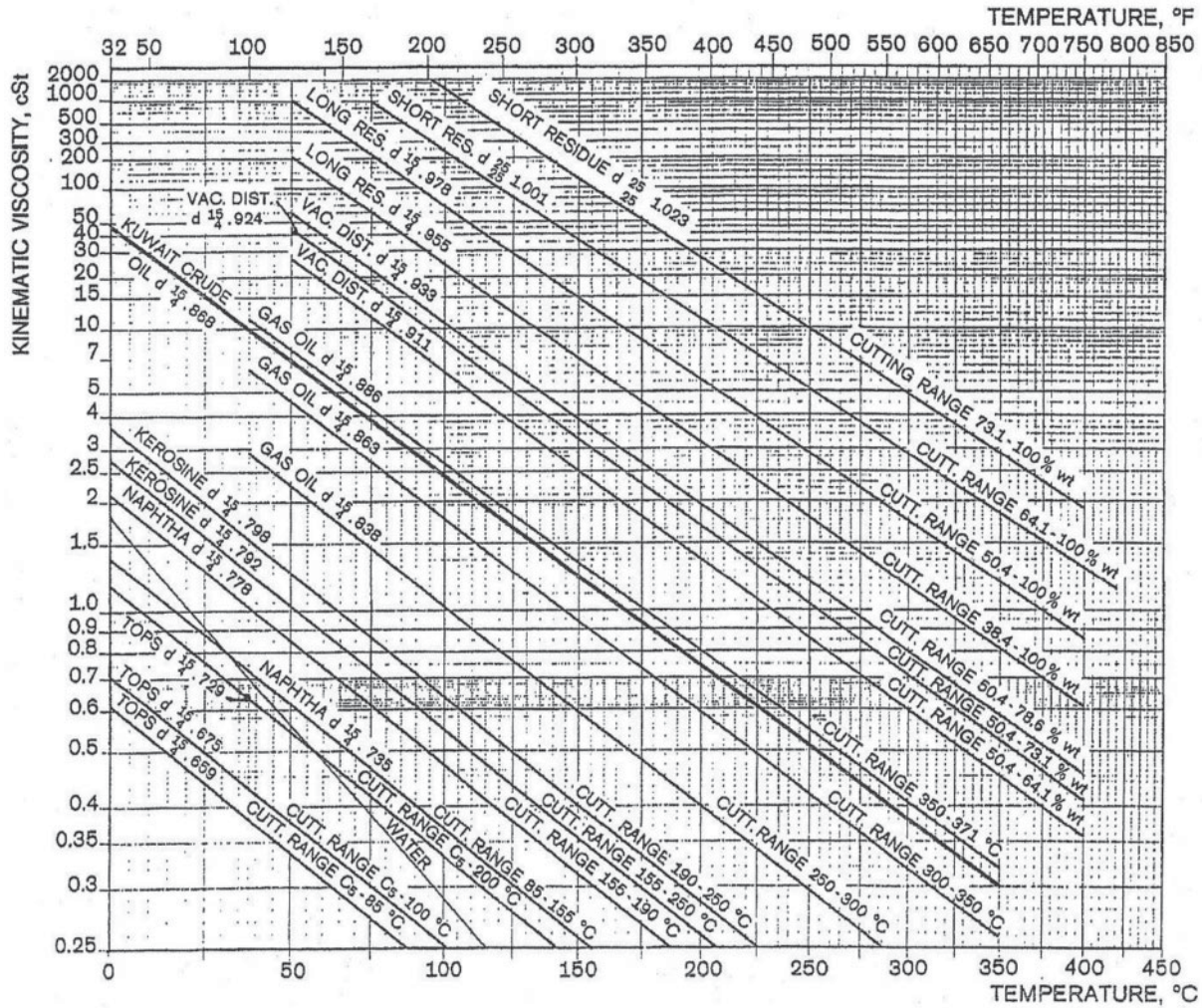


Figure 4.11 Kinematic viscosity-temperature chart for Kuwait crude oil and crude fractions (Source: Shell Technical Data Book).

$$\log \nu_{210} = -0.463634 - 0.166532(API) + 5.13447 \times 10^{-4}(API)^2 - 8.48995 \times 10^{-3}K(API) + \frac{8.0325 \times 10^{-2}K + 1.24899(API) + 0.197680(API)^2}{API + 26.786 - 2.6296K} \tag{4.47}$$

where ν_{100} and ν_{200} are the kinematic viscosities at 100 and 210 °F, in centistokes; K is the Watson characterization factor, API is the specific gravity of the petroleum fraction.

Figures 4.13 and 4.14 show plots of viscosity of liquid hydrocarbons and liquid solvents vs. temperature respectively.

$$1 \text{ cP} = 10^{-3} \text{ N.s/m}^2$$

4.4.5 Gas Viscosity

For most hydrocarbon's gas viscosity, Figure 4.15 (Fig. A-5 in Crane Technical Paper No. 410). The constant Sg is the molecular weight (MW) of the gas divided by the MW of air, 29. Figure 4.15 is limited to atmospheric pressure. The gas atmospheric reading from this figure or from other resources such as the API Technical Data Book is reasonably accurate for pressures up to 400 psig. In addition to the API Technical Data Book and Gas Processors Suppliers Association (GPSA) methods [31], the following equations apply for molecular weights of 15, 25, 50 and 100.

Table 4.8 Conversion between kinematic viscosity (cSt) and Saybolt universal viscosity, sec at 100 °F (38 °C) and 210 °F (99 °C)

Kinematic viscosity, cSt	Saybolt Universal viscosity, sec.	
	100° F (38° C)	210° F (99° C)
2	32.6	32.9
10	58.9	59.3
20	97.8	98.5
30	140.3	142.3
40	186.3	187.6
50	232.1	233.8
60	278.3	280.2
70	324.4	326.7

Table 4.9 Kinematic viscosity of some crude oils

Country	Crude	Kinematic viscosity, mm ² /s
Nigeria	Nigerian	9
Saudi Arabia	Safaniyah	48
Libya	Dahra	6
Venezuela	Bachaquero	5500

Viscosity, cP for 15 MW gas: $\mu = 0.0112 + 1.8e^{-05}T$ (4.48)

Viscosity, cP for 25 MW gas: $\mu = 0.00923 + 1.767e^{-05}T$ (4.49)

Viscosity, cP for 50 MW gas: $\mu = 0.00773 + 1.467e^{-05}T$ (4.50)

Viscosity, cP for 100 MW gas: $\mu = 0.0057 + 0.00001T$ (4.51)

where

μ = viscosity, cP
 T = Temperature, °F

Equations 4.48 to 4.51 are good for vacuum up to 500 psia pressure and temperature of -100 to 1000 °F. Pressures at or above 500 psia should have correlations added from Equations 4.52 to 4.54. Equations 4.48 to 4.51 are reasonably accurate to within 3% of the API data and are good for a pressure from atmospheric to approximately 400 psig.

In many unit operations, such as high pressure (≤ 500 psig) separators and fractionators, the gas viscosity variance with pressure is critical and can be significant

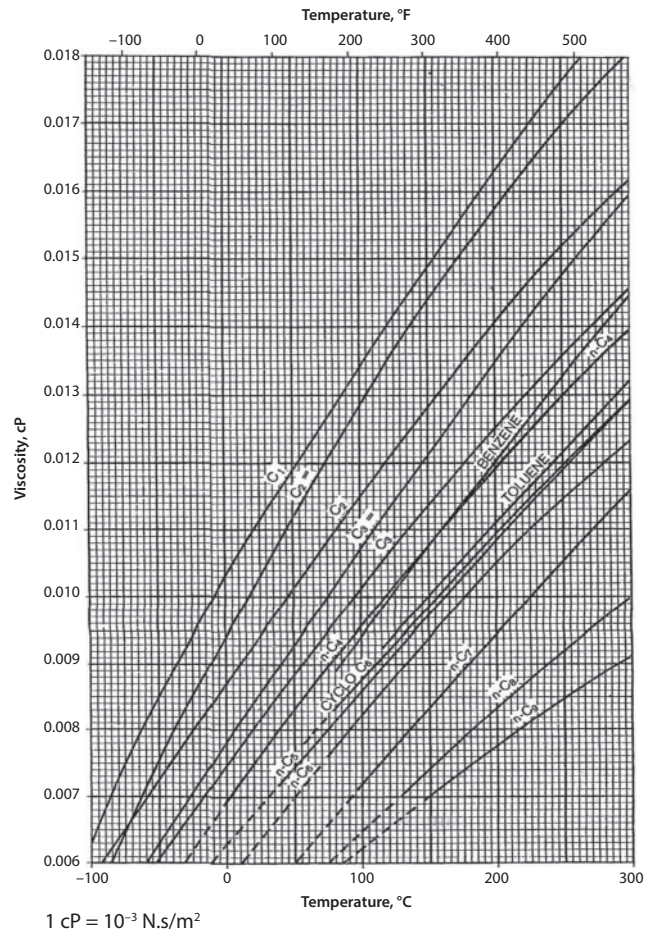


Figure 4.12 Viscosity of hydrocarbon vapors at 760 mm Hg (Source: API Technical Data Book).

in crude-oil production gas separators. In such cases, corrections can be employed with the following additional equations. These corrections are added to the atmospheric gas viscosity reading in Figure 4.15 or the gas viscosity Equations 4.48 to 4.51 as:

Gas viscosity correction for 100 °F system:

$$\mu_c = -1.8333e^{-05} + 1.2217e^{-06}P + 1.737e^{-09}P^2 - 2.1407e^{-13}P^3 \quad (4.52)$$

Gas viscosity correction for 400 °F system:

$$\mu_c = -1.281e^{-05} + 1.5484e^{-06}P + 2.249e^{-10}P^2 - 6.097e^{-14}P^3 \quad (4.53)$$

Gas viscosity correction for 800 °F system:

$$\mu_c = -1.6993e^{-05} + 1.1596e^{-06}P + 2.513e^{-10}P^2 \quad (4.54)$$

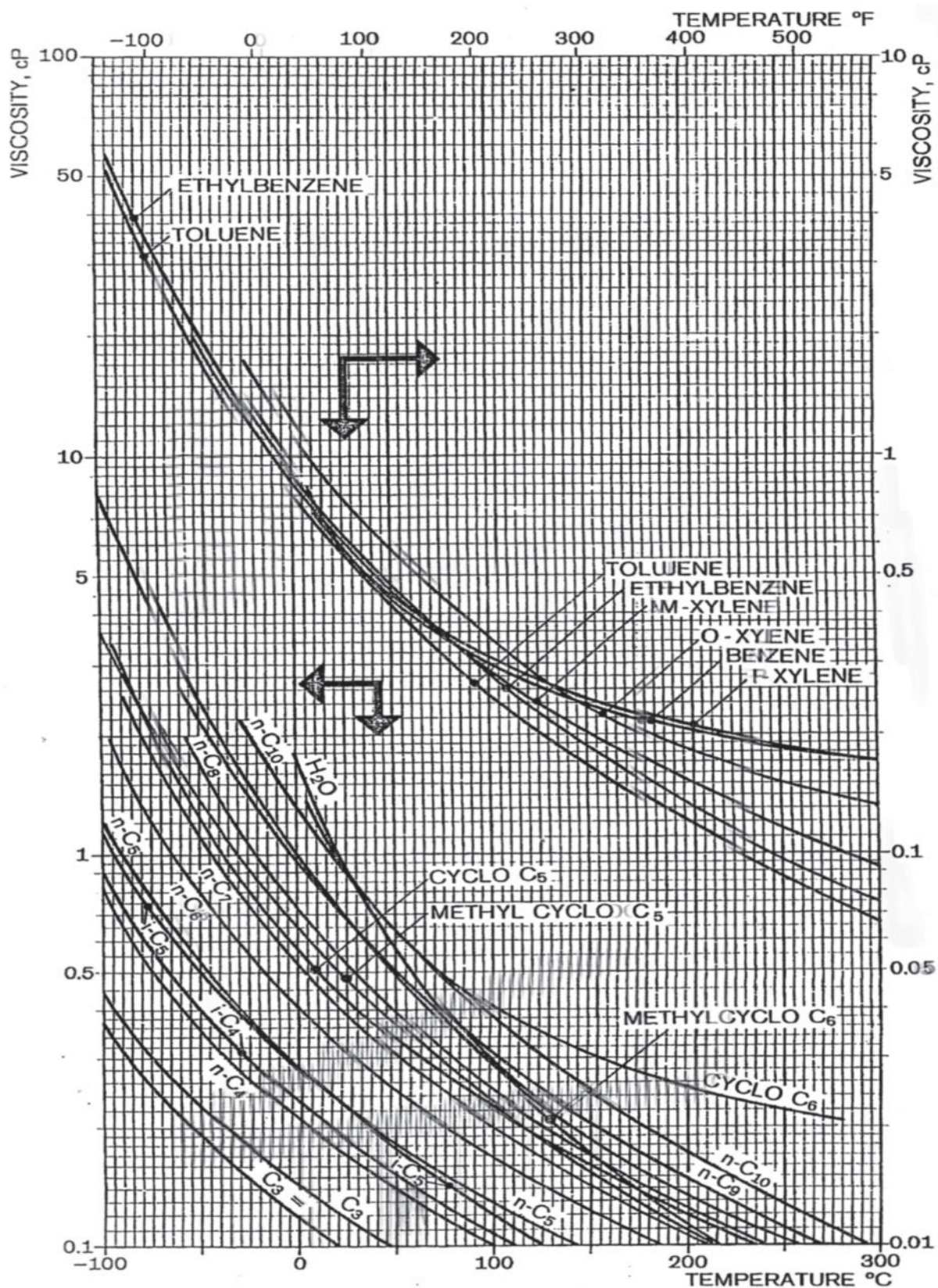


Figure 4.13 Viscosity of liquid hydrocarbons vs. temperature (Source: API Technical Data Book).

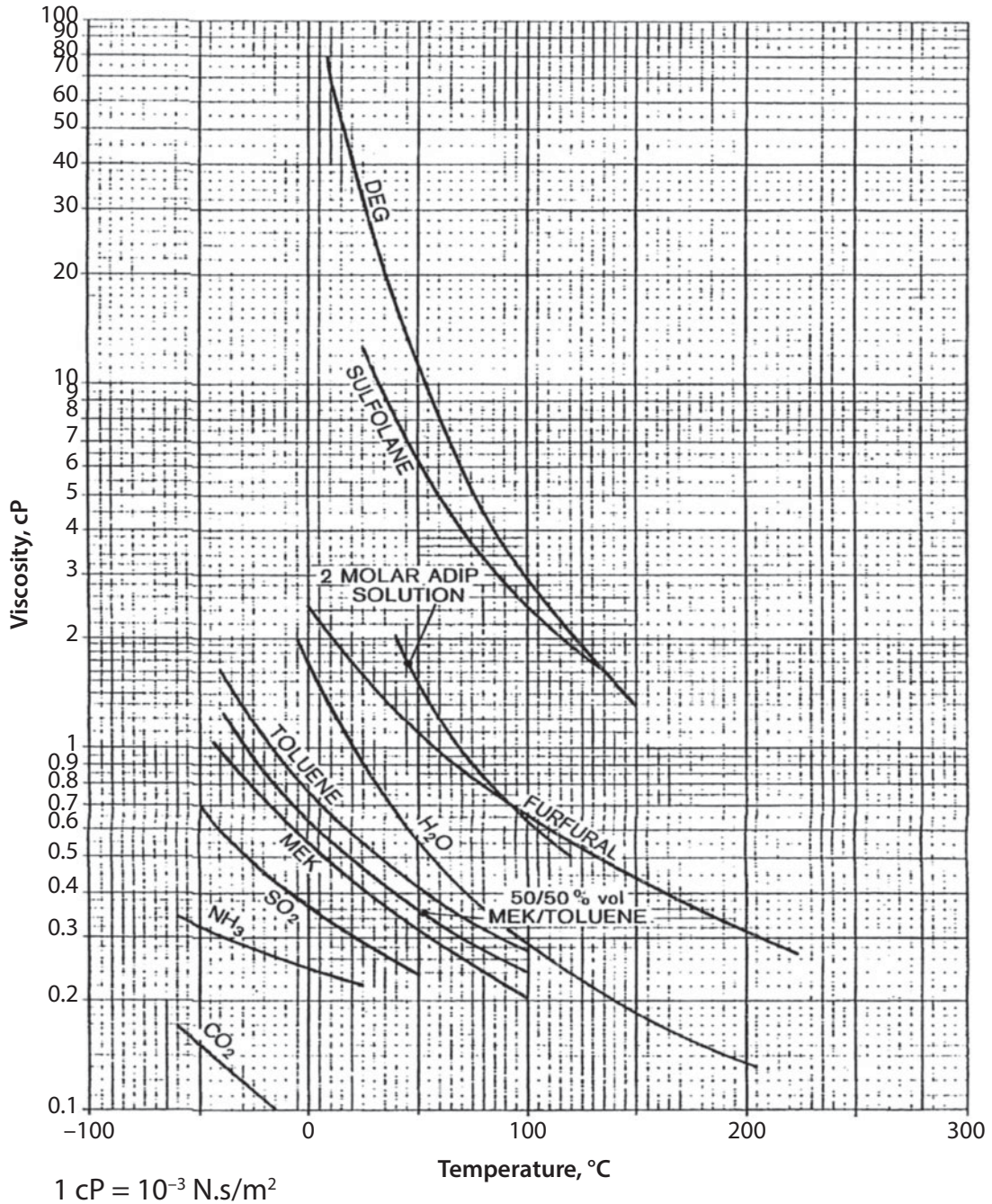


Figure 4.14 Viscosity of liquid solvents (Source: API Technical Data Book).

where

μ_c = viscosity increment, cP to be added to Figure 4.10 values or to Equations 4.48 to 4.51.

P = system pressure, psia.

Figure 4.16 shows plots of viscosity of non-hydrocarbon vapors at 760 mm Hg.

$$1 \text{ cP} = 10^{-3} \text{ N.s/m}^2$$

4.5 Refractive Index

The refractive index is a measured property, which is used as an input parameter for other correlations. It is defined as the speed of light in a vacuum with respect to the speed of light in the medium. Since, the refractive indices for petroleum fractions are not readily available; the following equation can be used to predict the refractive index. It is given by:

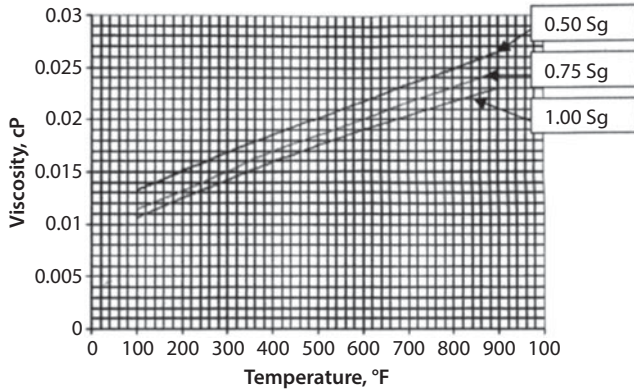


Figure 4.15 Hydrocarbon gas viscosity. (Adapted from Crane Technical Paper No. 410, Fig. A-5. Reproduced by courtesy of the Crane Company).

$$n = \left(\frac{1 + 2I}{1 - I} \right)^{0.5} \quad (4.55)$$

where

n = refractive index at 20 °C

I = the Huang characterization parameter at 20 °C (68 °F).

I may be determined from:

$$I = a \exp(bT_b + c SpGr + dT_b SpGr) T_b^e SpGr^f \quad (4.56)$$

where

T_b = mean average boiling point, °R (°F + 460)

SpGr = specific gravity of petroleum fraction, 60 °F/60 °F

where a, b, c, d, e, and f are the constants varying with molecular weight range as given in Table 4.10.

The characterization factor I at 20 °C can also be calculated as:

$$I = 3.587 \times 10^{-3} \times T_b^{1.0848} \left(\frac{MW}{d} \right)^{-0.4439} \quad (4.57)$$

where

I = characterization factor of Huang at 20 °C

T_b = mean average boiling point, K

MW = molecular weight of petroleum fraction

d = liquid density at 20 °C and 101.3 kPa, in kg/dm³

Example 4-4

Calculate the refractive index of a petroleum fraction with a liquid density of 0.790 kg/dm³, molecular weight of 164 and mean average boiling point of 472K.

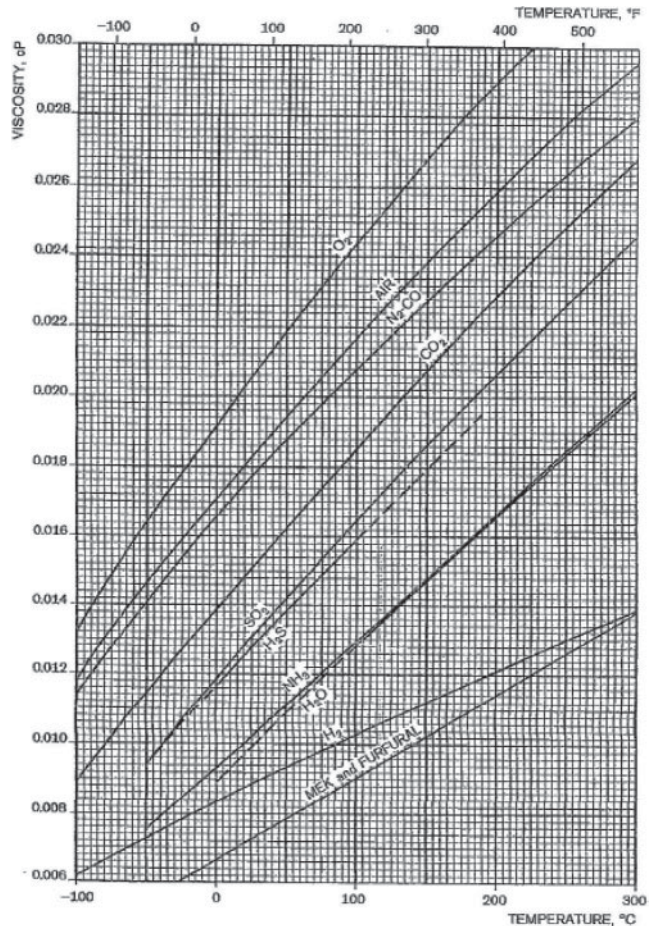


Figure 4.16 Viscosity of non-hydrocarbon vapors at 760 mm Hg (Source: API Technical Data Book).

Solution

d = 0.790 kg/dm³

MW = 164

T_b = 472K

From Equation 4.57, the Huang characterization factor is:

$$\begin{aligned} I &= 3.587 \times 10^{-3} \times T_b^{1.0848} \left(\frac{MW}{d} \right)^{-0.4439} \\ &= 3.587 \times 10^{-3} \times (472)^{1.0848} \left(\frac{164}{0.790} \right)^{-0.4439} \quad (4.57) \\ &= 0.2672 \end{aligned}$$

The refractive index is calculated by equation 4.55:

$$\begin{aligned} n &= \left(\frac{1+2I}{1-I} \right)^{0.5} \\ &= \left(\frac{1+2 \times 0.2672}{1-0.2672} \right)^{0.5} \\ &= 1.447 \end{aligned} \quad (4.55)$$

4.6 Liquid Density

Liquid density of hydrocarbon's petroleum fractions can be determined from Figure 4.17, which is a general reference and may be used for applications that are not critical for discrete defined components. A reading given as the API gravity at 60 °F on the crude oil assay or the petroleum product cut laboratory analysis is required. The API gravity is always referenced to one temperature, 60 °F and to water, which has a density of 62.4 lb/ft³ at this temperature. Any API reading of a hydrocarbon is, therefore, always referenced to 60 °F temperature and to water at 60 °F. This gravity is always noted as SpGr 60/60. This is the value that is interchangeable with the referenced hydrocarbons API value using equations:

$${}^{\circ}API = \frac{141.5}{SpGr\ 60/60} - 131.5 \quad (3.1)$$

or

$$SpGr\ 60/60 = \frac{141.5}{131.5 + {}^{\circ}API} \quad (3.1a)$$

Table 4.10 Constants for Equation 4.56.

Constants	Light fractions	Heavy fractions
Molecular weight range	70–300	300–600
Boiling point range (°F)	90–650	650–1000
a	2.266×10^{-2}	2.341×10^{-2}
b	3.905×10^{-4}	6.464×10^{-4}
c	2.468	5.144
d	-5.704×10^{-4}	-3.289×10^{-4}
e	0.0572	-0.407
f	-0.720	-3.333

Knowing the API value, the specific gravity of the hydrocarbon at any temperature can be obtained from Figure 4.17, noting that liquid specific gravities are always determined by dividing the known density of the liquid at a certain temperature by water at 60 °F or 62.4 lb/ft³. The following equation for evaluating liquid density is:

$$\rho_{liq} = \frac{MW}{\left(10.731 \frac{T_c}{P_c} \right) \times 0.260 \left[1.0 + (1.0 - T_r)^{0.2857} \right]} \quad (4.58)$$

where

ρ_{liq} = liquid density, lb/ft³

MW = molecular weight.

T_c = critical temperature, °R (°F + 460)

P_c = critical pressure, psia.

T_r = reduced temperature ratio = T/T_c

T = system temperature, °R, below the critical point.

Table 4.11 shows some crude types ranked according to °API and universal oil petroleum characterization factor K.

Figures 4.18 and 4.19 show plots and nomograph of the density of liquid hydrocarbons and liquid solvents respectively. Table 4.12 shows the boiling point and density of hydrocarbons and liquid solvents.

4.6.1 Gas Density

The gas density unlike the liquid density varies greatly with pressure as well as temperature as gas is a compressible fluid. At low pressure below 50 psia and at temperature below 100 °F, the ideal gas equation of state holds as the following expression.

$$\rho_{gas} = \frac{MW \times P}{10.73(T + 460)} \quad (4.59)$$

where

ρ_{gas} = gas density, lb/ft³

MW = gas molecular weight.

P = system pressure, psia.

T = temperature, °F.

For this low-temperature and pressure range, any gas density can be determined with an error less than 3%. However, at higher temperatures and pressures, where unit operations such as fractionation, separation, absorption, stripping, chemical reactions and heat exchangers generate and apply high temperatures

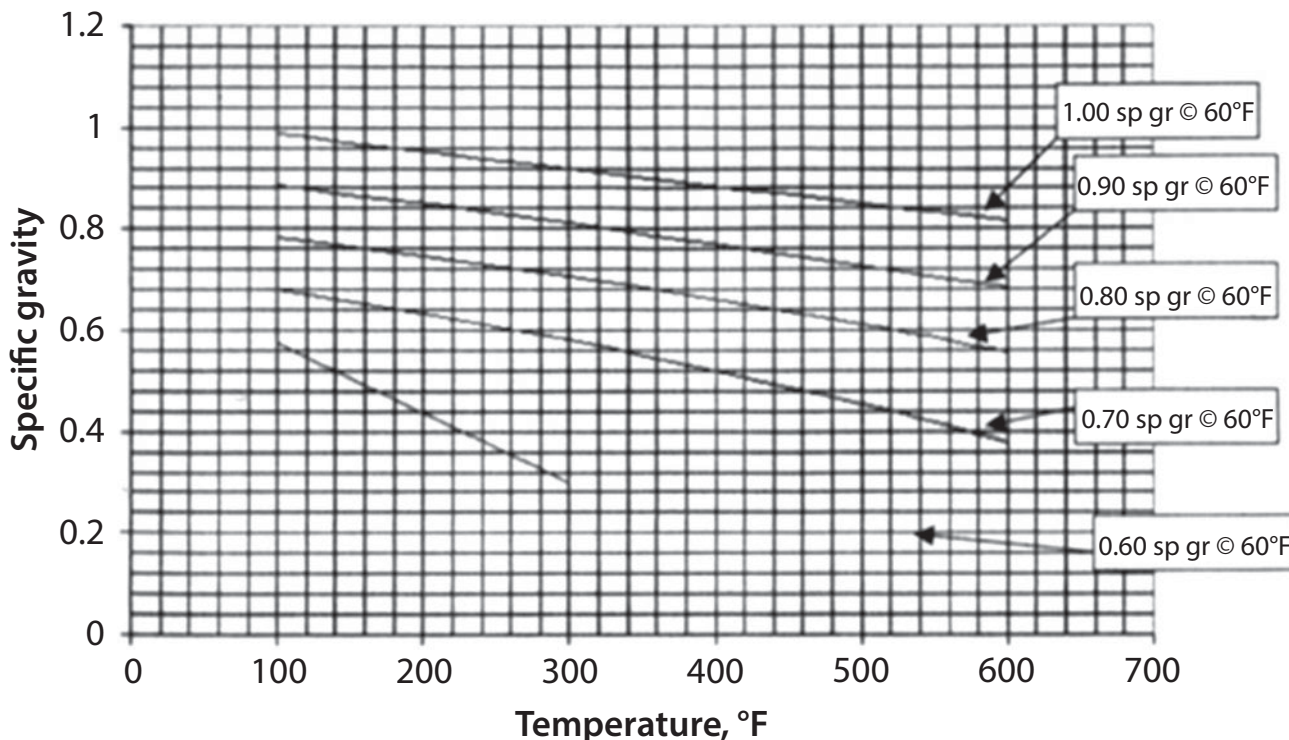


Figure 4.17 Specific gravity of petroleum fractions (Plotted from data in J. B. Maxwell, “Crude Oil Density Curves”, *Data Book on Hydrocarbon*, D. Van Nostran, Princeton, NJ, 1957, pp. 136–154.)

and pressure conditions, the term compressibility factor (Z), is introduced into Equation 4.58 as:

$$\rho_{gas} = \frac{MW \times P}{Z [10.73(T + 460)]} \quad (4.60)$$

where Z = gas compressibility factor.

Figure 4.20 shows the nomograph of density of ideal gases.

4.7 Molecular Weight

Molecular weights of petroleum fractions are essential for material or energy balance calculations. The average molecular weight can be determined by methods such as freezing point depression osmometry, or gel permeation chromatography. Generally, most oil fractions have molecular weights in the range 100–700. The method most adequate for evaluating molecular weights within this range is that based on freezing point depression. Pedersen *et al.* [30] developed

the following expression to determine the molecular weight of petroleum fractions:

$$MW = 42.965 \left[\frac{\exp(2.097 \times 10^{-4} T_b - 7.78712 SpGr + 2.08476 \times 10^{-3} T_b SpGr)}{T_b^{1.26007} SpGr^{4.98308}} \right] \quad (4.61)$$

where MW is the molecular weight of the petroleum fraction, T_b is the mean average boiling point of the petroleum fraction in K, and $SpGr$ is the specific gravity, 60 °F/60 °F.

4.8 Molecular Type Composition

An estimate of fractional composition of paraffins, naphthenes and aromatics contained in light and heavy petroleum fractions can be determined if the data on viscosity, relative density and refractive index of the desired fraction are known. The algorithm is based on a procedure of API databook as:

$$x_p = a + b(R_i) + c(VG) \quad (4.62)$$

$$x_n = d + e(R_i) + f(VG) \tag{4.63}$$

$$x_a = g + h(R_i) + i(VG) \tag{4.64}$$

and

$$R_i = n - \frac{d}{2} \tag{4.65}$$

where

- x_p = mole fraction of paraffins
- x_n = mole fraction of naphthenes
- x_a = mole fraction of aromatics
- R_i = refractive intercept as given by equation
- n = refractive index at 20 °C and 101.3kPa
- d = liquid density at 20 °C and 101.3kPa in kg/dm³

a, b, c, d, e, f, g, h and i = constants varying with molecular weight range

VG = viscosity gravity function VGC as given by equations 4.66 and 4.67 for heavy fractions or viscosity gravity function VGF as given by equations 4.68 and 4.69 for light fractions.

The constants used in equations 4.60 to 4.62 are shown in Table 4.13.

For heavy fractions (molecular weight 200–500), the viscosity gravity constant is determined by the following equations:

$$VGC = \frac{10d - 1.0752 \log(V_{311} - 38)}{10 - \log(V_{311} - 38)} \tag{4.66}$$

or

$$VGC = \frac{d - 0.24 - 0.022 \log(V_{372} - 35.5)}{0.755} \tag{4.67}$$

where d is the relative density at 15 °C and 101.3kPa and V is the Saybolt universal viscosity at 311 or 372K in Saybolt universal seconds.

For light fractions (molecular weight 80–200), the viscosity gravity constant is:

$$VGF = -1.816 + 3.484d - 0.1156 \ln(v_{311}) \tag{4.68}$$

or

$$VGF = -1.948 + 3.535d - 0.1613 \ln(v_{372}) \tag{4.69}$$

where v is the kinematic viscosity at 311 or 372K, in mm²/s

The viscosity gravity (VG) constant is a useful function for approximate characterization of viscous fractions of petroleum. It is relatively insensitive to molecular weight and related to the composition of the fraction. Values of VG near 0.8 show samples of paraffinic character while those of 1.0 indicate a preponderance of aromatic molecules. However, the VG should not be applied to residual oils or asphaltic materials.

Molecular type distribution of petroleum fraction is:

$$MW = 2.1905 \times 10^2 \times \exp(0.003924T) \times \exp(-3.07d) \times (T)^{0.118} (d)^{1.88} \tag{4.70}$$

where

- MW = molecular weight
- d = relative density at 15 °C
- T = mean average boiling point, K

Table 4.11 Crude density classification according to API (American Petroleum Institute)

API = (141.5/Sp.Gr) - 131.5 where Sp.Gr. is specific gravity 15./15.4 °C						
Crude		API	V50	Sulfur (wt%)		K _{UOP}
Boscan	Extra Heavy	9.2	38.8	4.99		11.26
Tia Juana Pes		11.8	36.1	2.72	Paraffinic	11.35
Champion		22.4	16.7	0.15		11.34
Arab Heavy		27.6	21.7	2.92		11.91
Forcados		31.2	14.1	0.15		11.72
Arab Light		32.9	14.7	1.90	Mixed	11.89
Iran Light		33.1	15.5	1.46		11.97
Oman		33.3	18.7	1.04		12.19
Brent		38.9	10.0	0.35		12.06
Minas		36	20.0	0.08		12.51
Bach Ho		41.3	17.4	0.03	Naphthenic	12.77
Tapis Pulai.	Extra Light	45.7	6.1	0.03		12.31

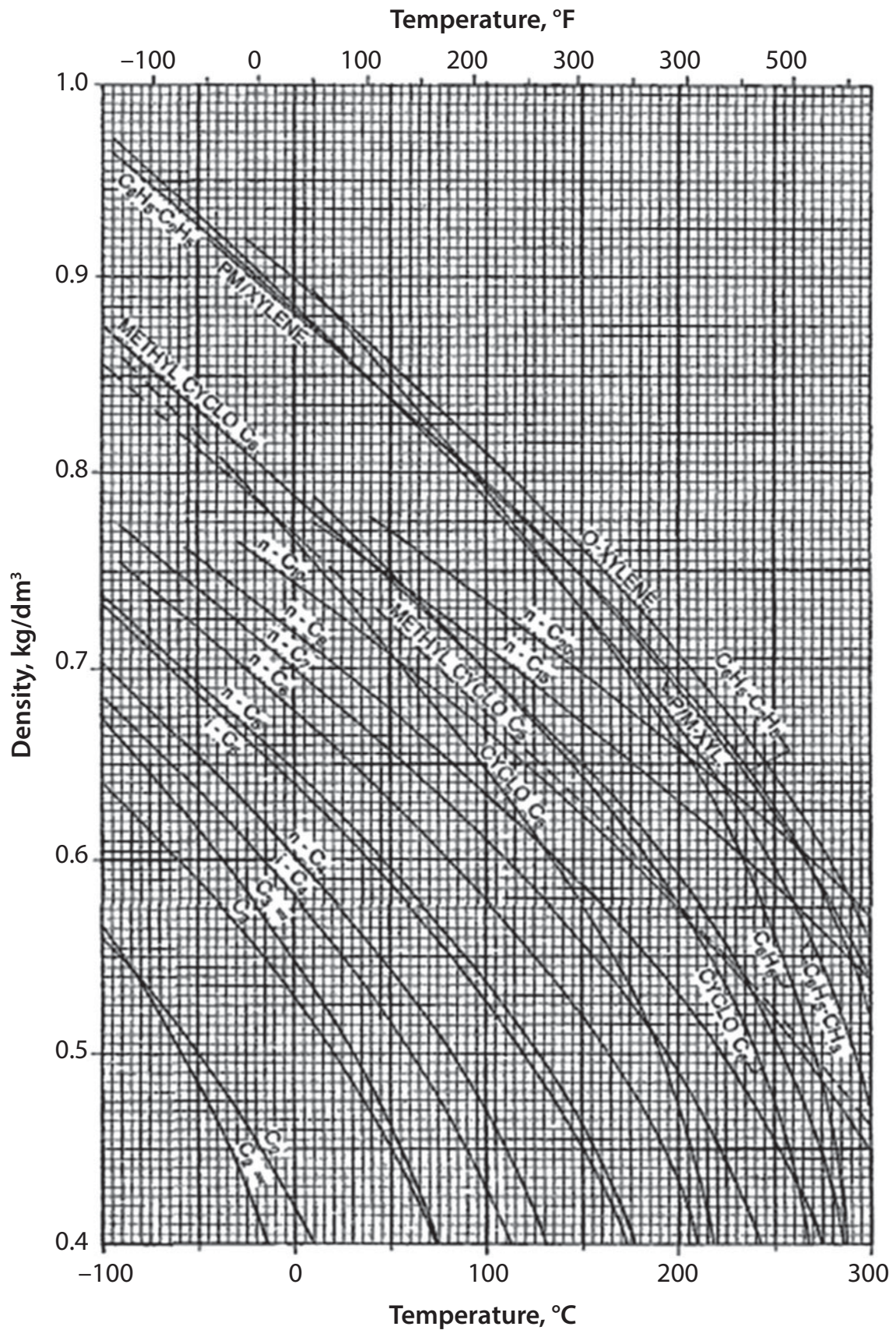


Figure 4.18 Density of liquid hydrocarbons (Source: API Technical Data Book)

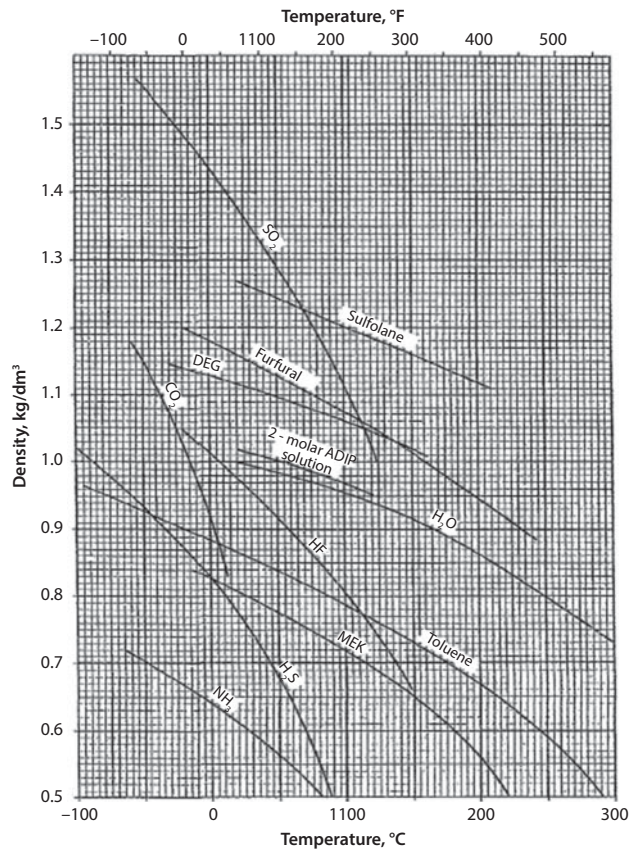


Figure 4.19 Density of liquid solvents (Source: API Technical Data Book).

Example 4-5

Calculate the molecular type distribution of a petroleum fraction of relative density 0.945 and refractive index 1.523, normal boiling point 750K and a viscosity of 690 Saybolt universal seconds at 311K.

Solution

First, determine the molecular weight of the fraction as a function of the mean average boiling point and relative density at 15 °C by Equation 4.70.

$$\begin{aligned}
 MW &= 2.1905 \times 10^2 \times \exp(0.003924T) \\
 &\quad \times \exp(-3.07d) \times T^{0.118} d^{1.88} \\
 &= 2.1905 \times 10^2 \times \exp(0.003924 \times 750) \\
 &\quad \times \exp(-3.07 \times 0.945) \times (750)^{0.118} (0.945)^{1.88} \\
 &= 449
 \end{aligned} \tag{4.70}$$

As the molecular weight is greater than 200, the fraction is termed heavy. Viscosity gravity constant VGC is calculated by Equation 4.66

$$\begin{aligned}
 VGC &= \frac{10d - 1.0752 \log(V_{311} - 38)}{10 - \log(V_{311} - 38)} \tag{4.66} \\
 &= \frac{10(0.945) - 1.0752 \log(690 - 38)}{10 - \log(690 - 38)} \\
 &= 0.8940
 \end{aligned}$$

The refractive intercept is determined by equation 4.65:

$$\begin{aligned}
 R_i &= n - \frac{d}{2} \tag{4.65} \\
 &= 1.523 - 0.945/2 \\
 &= 1.0505
 \end{aligned}$$

The mole fraction of paraffins, naphthenes and aromatics are calculated using Equations 4.62 to 4.64 and the constants in Table 4.13 as follows:

$$\begin{aligned}
 x_p &= a + b(R_i) + c(VG) \\
 &= -9.000 + 12.530(1.0505) + (-4.228)(0.8940) \\
 &= 0.3829
 \end{aligned} \tag{4.62}$$

$$\begin{aligned}
 x_n &= d + e(R_i) + f(VG) \\
 &= 18.660 + (-19.900)(1.0505) + 2.973(0.8940) \\
 &= 0.41294
 \end{aligned} \tag{4.63}$$

$$\begin{aligned}
 x_a &= g + h(R_i) + i(VG) \\
 &= -8.660 + (7.370)(1.0505) + (1.255)(0.8940) \\
 &= 0.20417
 \end{aligned} \tag{4.64}$$

$$\begin{aligned}
 x_p + x_n + x_a &= 0.3829 + 0.41294 + 0.20417 = 1.000 \\
 \sum x_p + x_n + x_a &= 1.0
 \end{aligned}$$

Table 4.12 Boiling point and density of substances (Source: API Technical Data Book)

Substance	Atmospheric boiling point, °C	Liquid density at atm. B.pt., kg/m ³	Liquid density at 15 °C, kg/m ³	Vapor density at 0 °C and 760 mm Hg., kg/m ³
Hydrogen	-252.8	70.8		0.090
Methane	-161.5	424.0	300.0*)	0.717
Ethylene	-103.7	570.0	472.0*)	1.26
Ethane	-88.6	547.0	457.0*)	1.35
Acetylene	- 81.5***)	617.0	472.0*)	1.17
Propylene	-47.7	610.0	521.8	1.92
Propane	-42.1	581.0	508.0	2.00
Isobutane	-11.7	595.0	563.1	2.67
n-Butane	-0.5	601.0	584.5	2.70
Isopentane	27.9	612.0	624.8	
n-Pentane	36.1	610.0	631.2	
Cyclopentane	49.3	717.0	750.5	
n-Hexane	68.7	614.0	664.0	
Methylcyclopentane	71.8	695.0	753.5	
Benzene	80.1	813.0	884.6	
Cyclohexane	80.7	719.0	783.4	
n-Heptane	98.4	613.0	688.1	
Methylcyclohexane	100.9	698.0	774.0	
Toluene	110.6	775.0	871.9	
n-Octane	125.7	612.0	706.9	
Ethylbenzene	136.2	762.0	871.8	
p-Xylene	138.4	754.0	865.8	
m-Xylene	139.1	759.0	868.8	
o-Xylene	144.4	768.0	884.8	
n-Nonane	150.8	608.0	722.0	
n-Decane	174.1	605.0	733.8	
n-C ₁₅	271.0	590.0	772.1	
n-C ₂₀	347.0	570.0	792.4**)	
n-C ₃₀	450.0	510.0	813.3**)	
n-C ₄₀	530.0		822.0**)	
n-C ₅₀	632.0		829.0**)	
Methyl ethyl ketone	79.6	741.0	810.0	
Furfural	161.7	998.0	1165.0	
Diethylene glycol	245		1120.0	
Sulfolane	285		1273.0	
N ₂	-195.8	812.0		1.25
Air	-194.5	860.0		1.29
CO	-191.5	791.0		1.25
CO ₂	-56.6***)	1178.0***)	815.0	1.98
O ₂	-183.0	1140.0		1.43

Table 4.12 Cont.

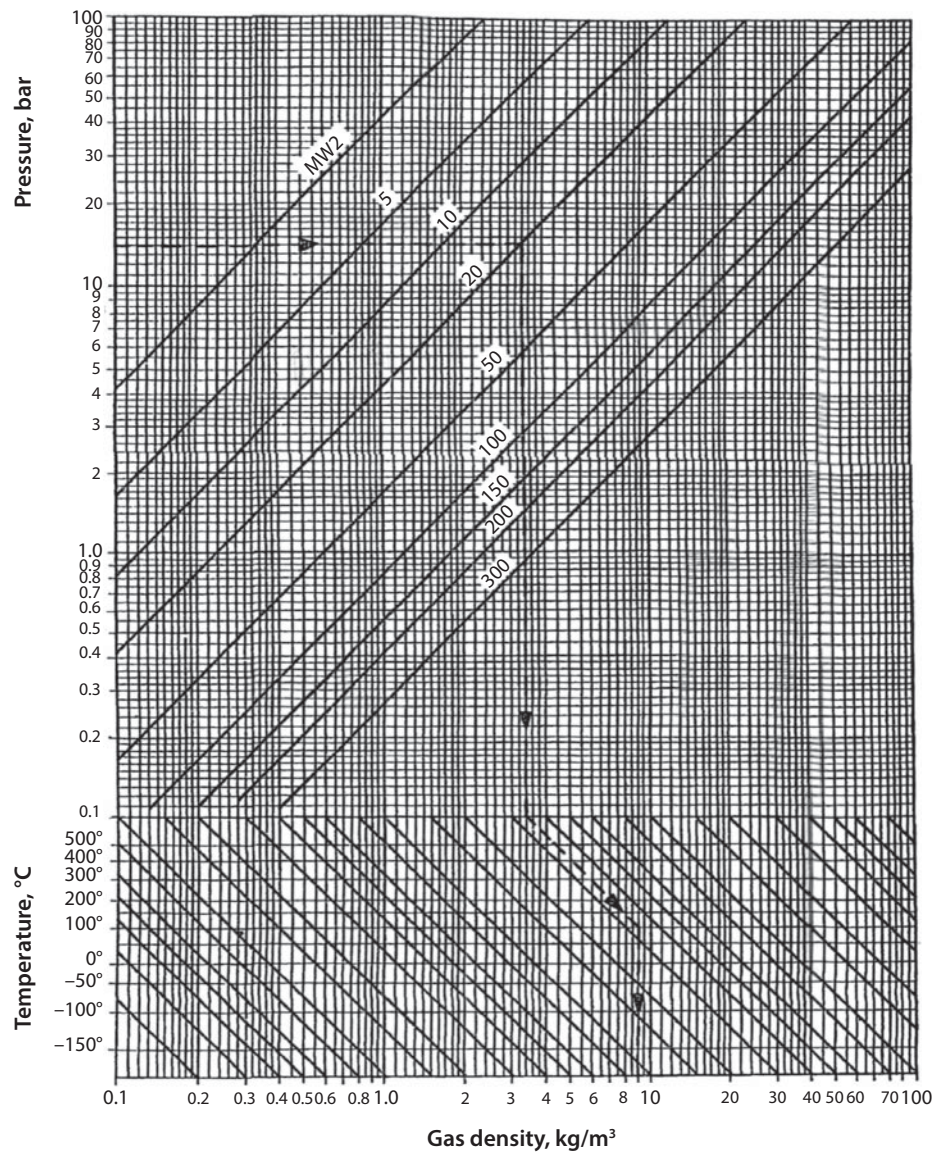
Substance	Atmospheric boiling point, °C	Liquid density at atm. B.pt., kg/m ³	Liquid density at 15 °C, kg/m ³	Vapor density at 0 °C and 760 mm Hg., kg/m ³
H ₂ S	-60.4	960.0	797.0	1.54
NH ₃	-33.4	678.0	617.0	0.771
SO ₂	-10.0	1460.0	1396.0	2.93
H ₂ O	100.0	958.0	999.0	

*) for use in heavy mixtures

**) for under cooled liquid

***) triple point conditions.

Source: API Technical Data Book



Note: This nomograph is the solution of $\rho = \frac{12.03}{T(K)} p(\text{bar}) \times MW$

Figure 4.20 Density of ideal gases. (Source: API Technical Data Book)

Table 4.13 Constants for Equations 4.62 to 4.64.

Constant	Light fraction (MW= 80–200)	Heavy fraction (MW = 200–500)
a	-23.940	-9.000
b	24.210	12.530
c	-1.092	-4.228
d	41.140	18.600
e	-39.430	-19.900
f	0.627	2.973
g	-16.200	-8.660
h	15.220	7.370
i	0.465	1.255

The Excel spreadsheet Example 4-5.xlsx shows calculations of Example 4-5.

Example 4-6

Calculate the molecular type distribution of a petroleum fraction of relative density 0.806 and refractive index 1.460, normal boiling point 470K and a viscosity of 1.29 mm²/s. at 311K.

Solution:

First, determine the molecular weight of the fraction as a function of the mean average boiling point and relative density at 15 °C by Equation 4.68.

$$\begin{aligned}
 MW &= 2.1905 \times 10^2 \times \exp(0.003924T) \quad (4.70) \\
 &\quad \times \exp(-3.07d) \times T^{0.118} d^{1.88} \\
 &= 2.1905 \times 10^2 \times \exp(0.003924 \times 470) \\
 &\quad \times \exp(-3.07 \times 0.806) \times (470)^{0.118} (0.806)^{1.88} \\
 &= 160.73
 \end{aligned}$$

As the molecular weight is less than 200, the fraction is termed light. Viscosity gravity constant VGC is calculated by Equation 4.68

$$VGF = -1.816 + 3.484d - 0.1156 \ln(\nu_{311}) \quad (4.68)$$

or

$$VGF = -1.948 + 3.535d - 0.1613 \ln(\nu_{372}) \quad (4.69)$$

$$\begin{aligned}
 VGF &= -1.816 + 3.484d - 0.1156 \ln(\nu_{311}) \\
 &= -1.816 + 3.484(0.806) - 0.1156 \ln(1.29) \\
 &= 0.9627
 \end{aligned}$$

The refractive intercept is determined by Equation 4.65:

$$\begin{aligned}
 R_i &= n - \frac{d}{2} \\
 &= 1.460 - 0.806 / 2 \\
 &= 1.057
 \end{aligned} \quad (4.65)$$

The mole fraction of paraffins, naphthenes and aromatics are calculated using Equations 4.62 to 4.64 and the constants in Table 4.13.

$$\begin{aligned}
 x_p &= a + b(R_i) + c(VG) \\
 &= -23.940 + 24.210(1.057) + (-1.092)(0.9627) \\
 &= 0.5987
 \end{aligned} \quad (4.62)$$

$$\begin{aligned}
 x_n &= d + e(R_i) + f(VG) \\
 &= 41.14 + (-39.43)(1.057) + 0.627(0.9627) \\
 &= 0.0661
 \end{aligned} \quad (4.63)$$

$$\begin{aligned}
 x_a &= g + h(R_i) + i(VG) \\
 &= -16.2 + (15.22)(1.057) + (0.465)(0.9627) \\
 &= 0.3352
 \end{aligned} \quad (4.64)$$

$$\begin{aligned}
 x_p + x_n + x_a &= 0.5987 + 0.0661 \\
 &+ 0.3352 = 0.999995
 \end{aligned}$$

$$\sum x_p + x_n + x_a = 1.0$$

The Excel spreadsheet Example 4-6.xlsx shows calculations of Example 4-6.

4.9 Critical Temperature, T_c

The critical property T_c is an important parameter for any hydrocarbon discrete single component or a mixture of components. It is essential to obtain critical temperature data resources as much as practical and Equation 4.71 provides an expression for calculating T_c for naphthene, olefin, and other family-type hydrocarbons [33].

$$T_c = 10^{[A + B \log(Sp.Gr) + C \log T_B]} \quad (4.71)$$

where

Sp.Gr. = Specific gravity 60/60

T_B = normal boiling temperature, °R (°F + 460)

Log notation is base 10.

A, B, and C constants

Constants	A	B	C
Paraffins	1.47115	0.43684	0.56224
Aromatics	1.14144	0.22732	0.66929
Olefins	1.18325	0.27749	0.65563

Equation 4.71 is good for paraffins up to 21 carbon atoms molecularly and up to 15 carbon atoms for all others. Table 4.14 shows critical component properties.

4.10 Critical Pressure, P_c

Table 4.14 provides an excellent resource for critical pressure, P_c is expressed by:

$$P_c = \frac{14.7 MW}{\left[(\text{sum DELTPI}) + 0.34 \right]^2} \quad (4.72)$$

where

P_c = critical pressure, psia.
 MW = molecular weight
 DELTPI = compound molecular group structure contribution
 Group Contribution DELTPI

Non-ring increment group contributions		Ring-increment group contributions	
—CH ₂	0.227	—CH ₂ —	0.184
— $\begin{array}{c} \\ \text{CH}_2 \end{array}$	0.227	— $\begin{array}{c} \\ \text{CH} \end{array}$	0.192
=CH ₂	0.198		
= $\begin{array}{c} \\ \text{CH}_2 \end{array}$	0.198	= $\begin{array}{c} \\ \text{CH}_2 \end{array}$	0.154
≡CH ₂	0.153	≡CH≡	0.154

Note: "sum" notation indicates the sum of DELTPI for each group contribution. Reid *et al.* [21] provide additional molecular group contributions. For benzene at Sp.Gr = 0.8844, MW = 78.11 and $T_B = 176.2^\circ\text{F}$ (636.2°R), the

Table 4.14 Critical component properties.

Component	MW	T_B , °F	Sp.Gr.	P_c , psia	T_c , °F	Acentric factor
Methane	16.04	-258.69	0.3	667.8	-116.63	0.0104
Ethane	30.07	-127.48	0.3564	707.8	90.09	0.0986
Propane	44.10	-43.67	0.5077	616.3	206.01	0.1524
n-Butane	58.12	31.10	0.5844	550.7	305.65	0.2010
Isobutane	58.12	10.90	0.5631	529.1	274.98	0.1848
n-Pentane	72.15	96.92	0.6310	488.60	385.70	0.2539
Isopentane	72.15	82.12	0.6247	490.40	369.10	0.2223
Neopentane	72.15	49.10	0.5967	464.00	321.13	0.1969
n-Hexane	86.17	155.72	0.6640	436.90	453.70	0.3007
2-Methylpentane	86.17	140.47	0.6579	436.60	435.83	0.2825
3-Methylpentane	86.17	145.89	0.6689	453.10	448.30	0.2741
Neohexane	86.17	121.52	0.6540	446.80	420.13	0.2369
2,3 Dimethylbutane	86.17	136.36	0.6664	453.50	440.29	0.2495
n-Heptane	100.2	209.17	0.6882	396.80	512.80	0.3498
2-Methylhexane	100.2	194.09	0.6830	396.50	495.00	0.3336
3-Methylhexane	100.2	197.32	0.6917	408.10	503.78	0.3257
3-Ethylpentane	100.2	200.25	0.7028	419.30	513.48	0.3095
2,2, Dimethylpentane	100.2	174.54	0.6782	412.20	477.23	0.2998
2,4, Dimethylpentane	100.2	176.89	0.6773	396.90	475.95	0.3048
3,3, Dimethylpentane	100.2	186.91	0.6976	427.20	505.85	0.2840
Triptane	100.2	177.58	0.6949	428.40	496.44	0.2568

Source: Data from Table 1C1.1, American Petroleum Institute, Technical Data Book, API Refining Department, Washington, DC, 1976.

critical temperature, T_c is:

The constants A and B for aromatics are:

$$A = 1.14144, B = 0.22732, C = 0.66929$$

$$\begin{aligned} T_c &= 10^{[A+B\log(Sp.Gr) + C\log T_b]} \\ &= 10^{[1.14144+0.22732\log(0.8844) + 0.66929\log 636.2]} \\ &= 1013.3^\circ\text{R or } 553^\circ\text{F} \end{aligned} \quad (4.71)$$

The critical pressure, P_c is:

Benzene has 6 CH_2 groups at 0.154 each or 0.924 total and sum DELTPI = 0.924

$$P_c = \frac{14.7(78.11)}{[0.924 + 0.34]^2} = 719.0 \text{ psia.} \quad (4.72)$$

Equations 4.71 and 4.72 are within a few percentage point error up to about 20 carbon atoms for paraffins and 14 carbon atoms per molecular structure for all others. For determining T_c and P_c from a mixture, having a known T_c and P_c for each component, use molar percentages of each component times the respective T_c and P_c . Then add these T_c and P_c values to obtain the sum T_c and P_c of the mixture.

4.11 Pseudo-Critical Constants and Acentric Factors

Generally, methods employed to calculate the thermodynamic properties and transport properties depend upon the principle of corresponding states and an equation of state. Using these methods requires the values of critical parameters as temperature and pressure and the Acentric factor as input constants. While these constants are known for defined components, they have to be estimated for narrow boiling petroleum cuts or pseudo-components. Lee and Kessler [33] developed the following equations to determine pseudo-critical temperature and pressure:

$$\begin{aligned} T_c &= 189.8 + 450.6 SpGr + (0.422 + 0.1174 SpGr) T_b \\ &+ \frac{(14,410 - 100,688 SpGr)}{T_b} \end{aligned} \quad (4.73)$$

where pseudo-critical temperature, T_c and the average boiling point, T_b are in K ($^\circ\text{C}+273$)

Pseudo-critical pressure, P_c is:

$$\begin{aligned} \ln P_c &= 5.689 SpGr - \frac{0.0566}{SpGr} \\ &- 10^{-3} T_b \left(0.436392 + \frac{4.12164}{SpGr} + \frac{0.213426}{SpGr^2} \right) \\ &+ 10^{-7} T_b^2 \left(4.75794 + \frac{11.819}{SpGr} + \frac{1.53015}{SpGr^2} \right) \\ &- 10^{-10} T_b^3 \left(2.45055 + \frac{9.901}{SpGr^2} \right) \end{aligned} \quad (4.74)$$

where P_c is in bar.

Acentric factor, ω

The equation for calculating the Acentric factor depends on the value of the reduced average normal boiling point NBP, $T_{br} = T_b/T_c$ as follows:

For $T_{br} < 0.8$

$$\begin{aligned} \omega &= \frac{(\ln P_{br} - 5.92714 + 6.09648/T_{br})}{(15.2518 - 15.6875/T_{br})} \\ &- 13.472 \ln T_{br} + 0.43577 T_{br}^6 \end{aligned} \quad (4.75)$$

where $P_{br} = P_b/P_c$ and P_b is the pressure at which T_b is measured which is atmospheric pressure.

For $T_{br} > 0.8$

$$\begin{aligned} \omega &= -7.904 + 0.1352K - 0.007465K^2 \\ &+ 8.359 T_{br} + (1.408 - 0.01063K)/T_{br} \end{aligned} \quad (4.76)$$

where K is the Watson characterization factor.

Riazi and Al-Sahhaf [34] presented a method for determining various properties at the normal boiling point (NBP), density, refractive index, critical temperature, pressure, density, Acentric factor, solubility parameter and surface tension given only the molecular weight and using the following general equation:

$$\theta = \theta_\infty - \exp(a - bMW^c) \quad (4.77)$$

where θ can be any one of the properties mentioned above, MW is the molecular weight and θ_∞ is the limiting value for any property as $MW \rightarrow \infty$. The generalized equation can be used to calculate the following properties knowing the molecular weight.

Table 4.15 Constants for the Riazi-Al-Shahhaf (Equation 4.77).

θ	θ_{∞}	a	b	c
T_b	1080	6.97996	0.01964	0.67
SpGr	1.07	3.56073	2.93886	0.1
d_{20}	1.05	3.80258	3.12287	0.1
I	0.34	2.30884	2.96508	0.1
T_{br}	1.20	-0.34742	0.02327	0.55
$-P_c$	0	6.34492	0.72390	0.3
$-d_c$	-0.22	-3.2201	0.00090	1
$-\omega$	0.30	-6.2520	-3.64457	0.1
σ	30.3	17.45018	9.70188	0.1
δ	8.60	2.29195	0.54907	0.3

T_b	Mean average boiling point, K
SpGr	Specific gravity
d_{20}	Liquid density at 20 °C or 68 °F
I	Huang characterization parameter
$T_{br} = T_b/T_c$	Reduced boiling point which is used to calculate the critical temperature, K
P_c	Critical pressure, bar
d_c	Critical density, g/cm ³
ω	Acentric factor
σ	Surface tension, dynes/cm
δ	Solubility parameter, (cal/cm ³) ²

The constants a, b, and c for each property are shown in Table 4.15. The application of Equation 4.77 requires the average NBP of the petroleum fraction. First, the molecular weight is calculated from the correlation using the constants for the boiling point. Once the molecular weight is known, other properties can be determined with the appropriate constants from Table 4.15.

Example 4-7

Use the Riazi and Al-Shahhaf [34] equation to determine the properties for oil that has mean average boiling point (MeABP) of 340 °C and 42 °API gravity.

Solution

The molecular weight is calculated from 4.64 using the boiling point of 340 °C and is 277. Using this value, other

properties in Table 4.15 are calculated using the Excel spreadsheet (Example 4-7.xlsx) and the values are shown below.

MW	269
SpGr	0.867
d_{20}	0.863
I	0.2846
T_{br}	0.7769
T_c	789K
P_c	11.4 bar
dc	0.251 g/cm ³
ω	0.854
σ	28.77 dynes/cm
δ	8.091 (cal/cm ³) ²

4.12 Enthalpy of Petroleum Fractions

Enthalpy and entropy as equations of state are required for the design of process equipment as heat exchangers and compressors. Different methods such as Peng-Robinson and Soave-Redlich-Kwong are used in process simulation programs for the calculation of thermodynamic properties; however, Lee-Kessler method is readily suitable for hand calculation.

The Lee-Kessler generalized correlation has the following expression for the compressibility factor:

$$Z = Z^0 + \omega Z^1 \quad (4.78)$$

Equation 4.78 can be used to calculate the molar volume as $V = RT/P$ or the mass density, as

$$\rho = M/V$$

The departure functions $H - H^{ig}$ is expressed by:

$$\left(\frac{H - H^{ig}}{RT_c} \right) = \left(\frac{H - H^{ig}}{RT_c} \right)^0 + \omega \left(\frac{H - H^{ig}}{RT_c} \right)^1 \quad (4.79)$$

The superscripts 0 and 1 refer to the value for the simple fluid and the correction terms respectively. These values are obtained from standard chemical engineering thermodynamics texts as functions of reduced temperature and pressure [35]. The critical temperature and critical pressure and the Acentric factor for the petroleum fraction can be obtained from

the equations in section 4.6. If the fraction is treated as being made up of pseudo-components, the critical temperature, critical pressure and Acentric factor can be calculated using the following simple mixing rule equations:

$$\begin{aligned} T_c &= \sum_i \gamma_i T_{ci} \\ P_c &= \sum_i \gamma_i P_{ci} \\ \omega &= \sum_i \gamma_i \omega_{ci} \end{aligned} \quad (4.80)$$

where γ_i is the mole fraction of each pseudo-component.

The enthalpy change of a fluid from state 1 at T_1 and P_1 to state 2 at T_2 and P_2 is given by:

$$H_2 - H_1 = (H_2 - H_2^{ig}) + (H_2^{ig} - H_1^{ig}) - (H_1 - H_1^{ig}) \quad (4.81)$$

To calculate the enthalpy with respect to a reference state, set, $H_1 = H_{ref} = 0$. If the reference state is at low pressure (ideal gas), then $(H_1 - H_1^{ig}) = 0$

The enthalpy equation becomes

$$H = (H - H^{ig}) + (H^{ig} - H_{ref}^{ig}) \quad (4.82)$$

The ideal gas enthalpy change is determined from the integration of the ideal gas heat capacity with temperature, i.e. $\Delta H = C_p \Delta T$

$$H_2^{ig} - H_1^{ig} = \int_{T_1}^{T_2} C_p^{ig} dT \quad (4.83)$$

The ideal gas heat capacity for petroleum fractions is expressed by:

$$C_p^{ig} = A + BT + CT^2 \quad (4.84)$$

Integration of Equation 4.84 gives:

$$H_2^{ig} - H_1^{ig} = A(T_2 - T_1) + \frac{B}{2}(T_2^2 - T_1^2) + \frac{C}{3}(T_2^3 - T_1^3) \quad (4.85)$$

Lee and Kessler [33] provide equations for the constants A, B and C as follows:

$$A = 4.183 MW \left(\begin{array}{l} -0.33886 + 0.02827K \\ -0.26105CF + 0.59332\omega CF \end{array} \right) \quad (4.86)$$

$$B = -7.5318 MW \left(\begin{array}{l} (0.9291 - 1.1543K + 0.0368K^2) 10^{-4} \\ + CF(4.56 - 9.48\omega) 10^{-4} \end{array} \right) \quad (4.87)$$

$$C = 13.5573 MW \left(\begin{array}{l} -1.6658 \times 10^{-7} \\ + CF(0.536 - 0.6828\omega) 10^{-7} \end{array} \right) \quad (4.88)$$

where

$$CF = \left[\frac{(12.8 - K)(10 - K)}{10\omega} \right]^2 \quad (4.89)$$

K is the Watson characterization factor and MW is the molecular weight. The calculated heat capacity in Equation 4.84 with T in K is kJ/(kg mol.K). Converting the value to kJ/(kg.K) is to divide by MW.

4.13 Compressibility Z Factor of Natural Gases

Many petroleum engineering and process design calculation dealing with natural gases require knowledge of deviation factors or compressibility Z factors. Experimental data from pressure-volume-temperature (P-V-T) measurements are seldom available. The Z factors are available in charts or tables as a function of pseudo-reduced temperatures, T_r and pressures P_r . However, use of these charts is often time consuming and involves complex calculations.

Computer programs [37-39] for calculating the Z factors have been developed solely as a function of temperature and pressure of the gas. Furthermore, numerical methods and mathematical representations of the charts have been used to estimate the Z factors. Takacs [40] reviewed the various methods of estimating the Z factors. Here, use is made of a modified form of the method developed by Awoseyin [41]. This method gives a compressibility factor to within 5% for natural hydrocarbon gases with specific gravities between 0.5 and 0.8 and for pressures up to 5000 psia. The Z factor can be expressed as:

$$Z = F_1 \left\{ \frac{1}{\left(\frac{A_6 P 10^{[1.785S_g]}}{1 + \frac{1}{T^{3.825}}} \right)} + F_2 F_3 \right\} + F_4 + F_5 \quad (4.90)$$

where

$$F_1 = P(0.251 S_g - 0.15) - 0.202 S_g + 1.106 \quad (4.91)$$

$$F_2 = 1.4 e^{\{-0.0054(T-460)\}} \quad (4.92)$$

$$F_3 = A_1 P^5 + A_2 P^4 + A_3 P^3 + A_4 P^2 + A_5 P \quad (4.93)$$

$$F_4 = \{0.154 - 0.152 S_g\} P^{(3.185 S_g - 1.0)} e^{(-0.5P)} - 0.02 \quad (4.94)$$

$$F_5 = 0.35 \left\{ (0.6 - S_g) e^{\left[-1.039(P-1.8)^2 \right]} \right\} \quad (4.95)$$

The values of the constants A_1 , A_2 , A_3 , A_4 , A_5 and A_6 are:

$$A_1 = 0.001946$$

$$A_2 = -0.027635$$

$$A_3 = 0.136315$$

$$A_4 = -0.23849$$

$$A_5 = 0.105168$$

$$A_6 = 3.44 \times 10^8$$

The specific gravity S_g , of natural gas can be calculated from its density or molecular weight. This is

expressed as the ratio of the gas density at 60 °F and 1 atm (14.7 psia), $\rho_{\text{gas}, 60 \text{ °F}}$ to the density of air, $\rho_{\text{air}, 60 \text{ °F}}$ under the same conditions.

$$S_g = \frac{\text{density of gas}}{\text{density of air}} \quad (4.96)$$

Using the molecular weight of the gas, S_g can be expressed as:

$$S_g = \frac{\text{molecular weight of gas}}{\text{molecular weight of air}} \quad (4.97)$$

$$= \frac{M_{w, \text{gas}}}{M_{w, \text{air}}}$$

The Excel spreadsheet (compressibility-Z-factor.xls) calculates the compressibility Z factor of natural gases as a function of temperature, pressure and specific gravity. Figure 4.21 gives a plot of the compressibility Z factor of natural gases at 60 °F as a function of pressure and specific gravity.

Generalized Compressibility Z Factor

The two-parameter Redlich-Kwong (R-K) equation of state has an accuracy that compares well with more complicated equations that use more than more constants (when applied to non-polar compounds). The R-K equation is a cubic equation in the volume (or in the compressibility factor) for which analytical solutions can be found. Table 4.3 lists a few of the commonly used equations of state from among the hundreds that have been proposed that involve two or more coefficients. These equations are empirical and have proved remarkably robust in describing a wide variety of systems. Tables 4.3 and 4.3.1 list some of the values of the coefficients in the van der Waals' and Redlich-Kwong (R-K) equations and a few values of Acentric factor (ω) for common gases respectively. Here, the R-K expression is used to illustrate the general characteristics of cubic equations of state.

Equations

The R-K equation is expressed by [42]:

$$P = \frac{RT}{V-b} - \frac{a}{V(V+b)T^{0.5}} \quad (4.98)$$

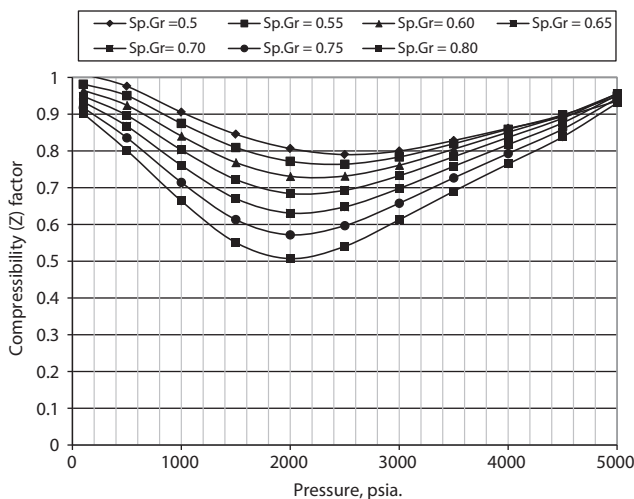


Figure 4.21 Plots of Compressibility factor of natural gas at 60 °F, and specific gravities of between 0.5 to 0.8.

where

$$a = 0.42747 \left(\frac{R^2 T_c^{2/5}}{P_c} \right) \quad (4.99)$$

$$b = 0.08664 \left(\frac{RT_c}{P_c} \right) \quad (4.100)$$

and

P = Pressure (atm)

V = Molar volume (liter/g-mol)

T = Temperature (K)

R = Universal gas constant [R = 0.08206 (atm liter/g-mol K)]

T_c = critical temperature (K)

P_c = critical pressure (atm)

Eliminating V from Equation (4.98) and writing it as a cubic equation of the compressibility factor Z gives

$$f(Z) = Z^3 - Z^2 - qr - r = 0 \quad (4.101)$$

where

$$r = A^2 B$$

$$q = B^2 + B - A^2$$

$$A^2 = 0.42747 \left(\frac{P_R}{T_R^{2.5}} \right) \quad (4.102)$$

$$B = 0.08664 \left(\frac{P_R}{T_R} \right) \quad (4.103)$$

where

$$P_r = P/P_c \text{ and } T_r = T/T_c$$

Equation (4.101) can be solved analytically for three roots, some of which may be complex. Considering only the real roots, the sequence of calculations involves the following steps:

$$C = \left(\frac{f}{3} \right)^3 + \left(\frac{g}{2} \right)^2 \quad (4.104)$$

where

$$f = \frac{-3q-1}{3}$$

$$g = \frac{-27r-9q-2}{27}$$

If $C > 0$, there is one real solution for Z, which can be expressed by

$$Z = D + E + \frac{1}{3} \quad (4.105)$$

where

$$D = \left(-\frac{g}{2} + \sqrt{C} \right)^{1/3}$$

and

$$E = \left(-\frac{g}{2} - \sqrt{C} \right)^{1/3}$$

If $C < 0$, there are three real solutions for Z, and these are expressed by

$$Z_i = 2\sqrt{\frac{-f}{3}} \cos \left[\left(\frac{\theta}{3} \right) + \frac{2\pi(i-1)}{3} \right] + \frac{1}{3}, \quad i = 1, 2, 3 \quad (4.106)$$

where

$$\theta = a \cos \sqrt{\frac{g^2/4}{-f^3/27}} \quad (4.107)$$

After computing the compressibility factor, the molar volume (V), the isothermal enthalpy departure (ΔH), the isothermal entropy departure (ΔS) and the fugacity coefficient (ψ) can then be calculated from the following equations as follows:

$$V = \frac{ZRT}{P} \quad (4.108)$$

$$\frac{\Delta H^*}{RT} = \frac{3a}{2bRT^{1.5}} \ln \left(1 + \frac{b}{V} \right) - (Z-1) \quad (4.109)$$

$$\frac{\Delta S^*}{R} = \frac{a}{2bRT^{1.5}} \ln \left(1 + \frac{b}{V} \right) - \ln \left(Z - \frac{Pb}{RT} \right) \quad (4.110)$$

$$\psi = \exp \left\{ Z - 1 - \ln \left[Z \left(1 - \frac{b}{V} \right) \right] - \frac{a}{2bRT^{1.5}} \ln \left(1 + \frac{b}{V} \right) \right\} \quad (4.111)$$

In the supercritical region, two of these solutions are negative, so the maximal Z_i is selected as the true compressibility factor. The generalized compressibility factor similar to that shown in Figure 4.22 should not be used for strongly polar fluids, nor are they recommended for helium, hydrogen, or neon unless special, modified critical constants are used [18]. Many versions of Figure 4.22 have been published, although all differ somewhat, as each reflects the choice of experimental data and how they are smoothed. In some of the charts, V can be found directly from the lines of $V_r = V/(RT_c/P_c)$. Equations of state (EOS) mathematically represent graphical information as shown in Poling, *et al.* [18], and modern computers obviate the need to manually

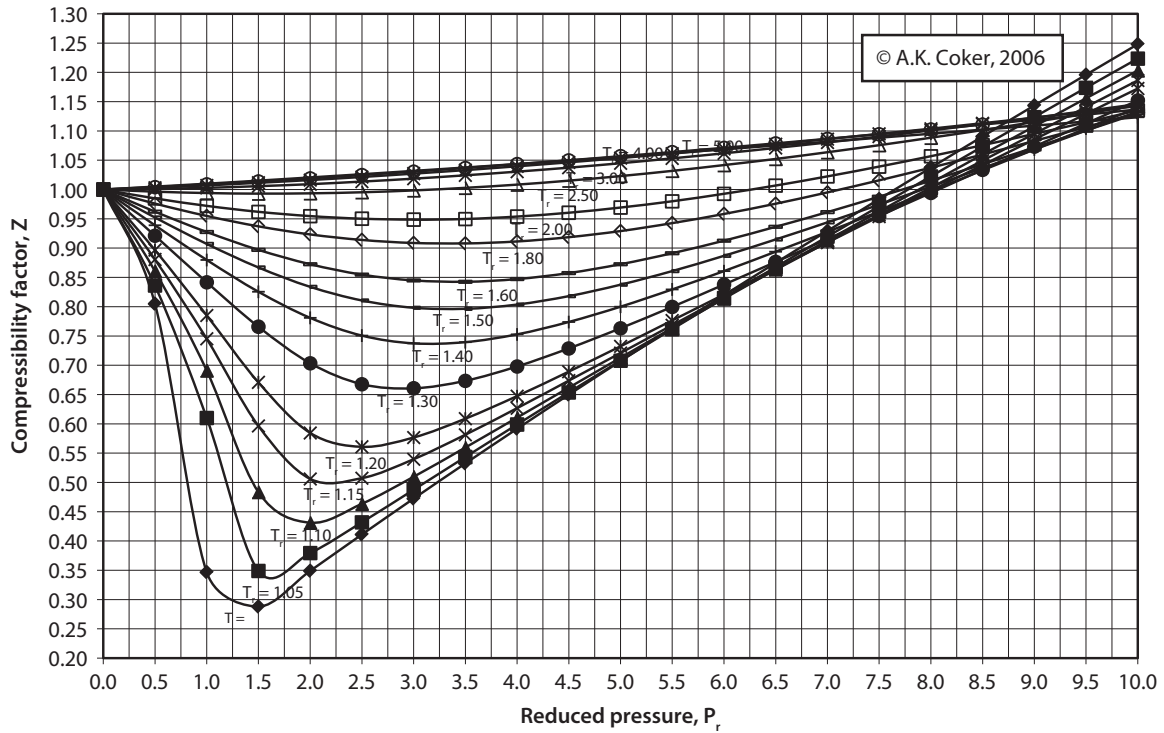


Figure 4.22 Generalized compressibility factor chart.

obtain volumetric behavior such as graphs and also allow more accurate results by using equations with component specific parameters.

Gas Mixtures

For gas mixtures, Kay’s method using pseudocritical values of mixtures of gases is calculated on the assumption that each component in the mixture contributes to the pseudocritical value in the same proportion as the number of moles of that component. Thus, the pseudocritical values are calculated as [43]:

Pseudocritical Temperature:

$$T'_c = y_A T_{cA} + y_B T_{cB} + y_C T_{cC} + \dots \quad (4.112)$$

Pseudocritical Pressure:

$$P'_c = y_A P_{cA} + y_B P_{cB} + y_C P_{cC} + \dots \quad (4.113)$$

where y_A, y_B, y_C are mole fractions of species A, B, C,.... in the mixture. Assuming that the system temperature T and pressure P are known, the pseudocritical properties can be used to estimate the pseudoreduced temperature and pressure of the mixture as:

Pseudoreduced Temperature: $T'_r = T/T'_c \quad (4.114)$

Pseudoreduced Pressure: $P'_r = P/P'_c \quad (4.115)$

The compressibility factor for a gas mixture, Z_m can then be estimated from the compressibility charts and

the pseudoreduced properties, and \hat{V} for the mixture can be calculated as

$$\hat{V} = \frac{Z_m RT}{P} \quad (4.116)$$

As with single-component gases, if \hat{V} and either T or P are known, the ideal pseudocritical volume $\hat{V}_r^{ideal} = \hat{V}'_c / RT'_c$ and the other known reduced property is used to determine the unknown temperature and pressure from the compressibility chart.

Kay’s rule provides only approximate values of the quantities it is used to calculate, and works best when applied for mixtures of nonpolar compounds whose critical temperatures and pressures are within a factor of two of one another [44].

The Excelspreadsheet (Generalized-compressibility-Z-factor.xls) calculates the compressibility Z factor as a function of reduced temperature and pressure, and Figure 4.22 shows a plot of the generalized compressibility Z factor using critical temperature for water $T_c = 647.4$ K, and critical pressure of water $P_c = 218.3$ atm.

Example 4-8

A stream of propane at temperature $T = 423$ K and pressure P (atm) flows at a rate of 100.0 kmol/h. Use the R-K equation of state to estimate the volumetric flow rate of the stream for $P = 0.7$ atm, 7 atm, and 70 atm. In

each case, calculate the percentage differences between the predictions of the R-K equation and the ideal gas equation of state [45].

Solution

The calculation of \hat{V} (L/mol) proceeds as follows. The R-K equation of state is expressed in the form

$$f(\hat{V}) = P - \frac{RT}{V-b} + \frac{a}{V(V+b)T^{0.5}} = 0$$

The values of T_c , P_c are looked up; a and b are calculated from the given formulas; specified values of T and P are substituted; and the value of \hat{V} for which $f(\hat{V}) = 0$ is found by trial and error.

$T_c = 369.9$ K, $P_c = 42$ atm, $R = 0.08206$ (L-atm)/(mol K)

$$a = 0.42747 \left(\frac{R^2 T_c^{2/5}}{P_c} \right) \left(\frac{L - atm}{mol K} \right)^2 \left(\frac{K^2 K^{0.5}}{atm} \right) = \left(\frac{L^2 - atm K^{0.5}}{mol^2} \right) \quad (4.99)$$

$$= 180.36 \left(\frac{L^2 - atm K^{0.5}}{mol^2} \right)$$

$$b = 0.08664 \left(\frac{RT_c}{P_c} \right) \left(\frac{L - atm}{mol K} \right) \left(\frac{K}{atm} \right) = \frac{L}{mol} \quad (4.100)$$

$$= 0.062 \text{ (L/mol)}$$

The percentage difference between \hat{V}_{RK} and $\hat{V}_{ideal} = (RT/P)$ is

$$Error \% = \frac{\hat{V}_{ideal} - \hat{V}_{RK}}{\hat{V}_{RK}} \times 100\%$$

Once \hat{V} is known for a given P , the volumetric flow rate corresponding to a molar flow rate of 100 kmol/h. is

$$\hat{V} (\text{m}^3/\text{h}) = \frac{V^3 (\text{L})}{\text{mol}} \frac{10^3 \text{ mol}}{1 \text{ kmol}} \frac{1 \text{ m}^3}{10^3 \text{ L}} \frac{100.0 \text{ kmol}}{h} = 100.0 \hat{V} (\text{L/mol})$$

The Excel spreadsheet (Example 4-8.xlsx) calculates the volumetric flow rate of the stream for $P = 0.7$ atm, 7 atm, and 70 atm. In each case, the Excel program calculates the percentage difference between the predictions of the R-K equation and the ideal gas equation of state.

Figure 4.23 (Example 4-8.xlsx) shows the display contents of rows 1, 3–5, 7 and 8, which are entered exactly except for the given formulas in Cells B4, D4, F4, D5 and F5. After the cell contents of Row 9 have been entered, they are copied into Rows 10 and 11, and the pressures in column A are then changed to their desired values. The entries in Cells C9–C11 (the initial guesses for \hat{V}) are the values copied from the adjacent cells in column B (the values obtained using the ideal gas equation of state). The correct values are then obtained by trial and error; for example, the value in Cell C9 is varied until the value in Cell D9 is close to

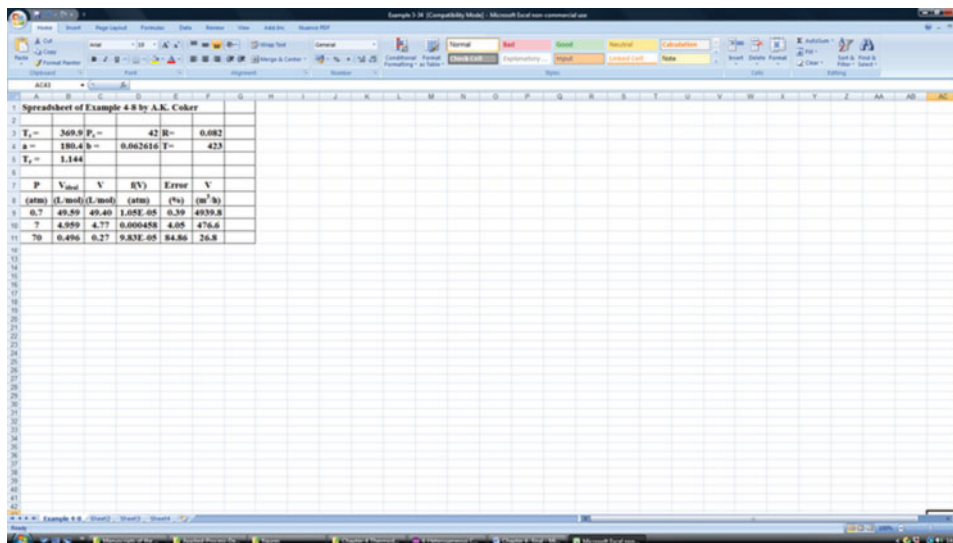


Figure 4.23 Snapshot of Microsoft Excel worksheet of Example 4-8.

zero using the Goalseek tool in Add-on of the Excel tool and similarly for Rows 10 and 11.

A published study provides experimental data for the PVT behavior of propane [48]. The data indicate that at 423 K and 70 atm, the value of \hat{V} is 0.2579 L/mol. The percentage error in the R-K estimate ($\hat{V} = 0.2682$ L/mol) is 3.9%, and that in the ideal gas estimate ($\hat{V}_{\text{ideal}} = 0.4959$ L/mol) is 92%.

Figure 4.23. Snapshot of Microsoft Excel worksheet of Example 4-8.

Example 4-9

A gaseous mixture has the following composition (in mole percent) at 90 atm pressure and 100 °C as shown [45].

Component	Mole percent (%)	T_c (K)	P_c (atm)
Methane (CH ₄)	20	191	45.8
Ethylene (C ₂ H ₄)	30	283	50.9
Nitrogen (N ₂)	50	126	33.5
Total	100		

Compare the volume per mole as computed by the methods of:

- The perfect gas law
- The pseudoreduced technique (Kay's method).

$$\text{Use } R = 82.06 \frac{(\text{cm}^3)(\text{atm})}{(\text{g mol})(\text{K})}$$

Solution

- From the perfect gas law:

$$PV = nRT$$

Basis: 1 g mol of gas mixture

$$V = \frac{nRT}{P} = \frac{1(82.06)(373)}{90} \left\{ \frac{(g \text{ mol})(\text{cm}^3)(\text{atm})(\text{K})}{(g \text{ mol})(\text{K})} \right\} = 340.1 \text{ cm}^3 \text{ at } 90 \text{ atm and } 373 \text{ K}$$

- Using Kay's method, the pseudocritical values for the mixture are:

Pseudocritical Temperature:

$$T'_c = y_A T_{cA} + y_B T_{cB} + y_C T_{cC} + \dots$$

Pseudocritical Pressure:

$$P'_c = y_A P_{cA} + y_B P_{cB} + y_C P_{cC} + \dots$$

$$T'_c = (191)(0.2) + (283)(0.3) + (126)(0.5) = 186 \text{ K}$$

$$P'_c = (45.8)(0.2) + (50.9)(0.3) + (126)(0.5) = 41.2 \text{ atm.}$$

Pseudoreduced Temperature: $T'_r = T/T'_c$

$$T'_r = \frac{373}{186} = 2.01$$

Pseudoreduced Pressure: $P'_r = P/P'_c$

$$P'_r = \frac{90}{41.2} = 2.18$$

Using these parameters, the compressibility Z factor is 0.965, and \hat{V} is

$$V = \frac{ZnRT}{P} = \frac{(0.965)(1)(82.06)(373)}{90} = 328.2 \text{ cm}^3 \text{ at } 90 \text{ atm and } 373 \text{ K}$$

Error percent between the perfect gas law and the Kay's method is:

$$\begin{aligned} \text{Error \%} &= \left(\frac{V - V'}{V'} \right) \times 100 \\ &= \left(\frac{340.1 - 328.2}{328.2} \right) \times 100 \\ &= 3.6\% \end{aligned}$$

4.14 Simulation Thermodynamic Software Programs

One of the basic tests of a thermodynamic model is to find the relevant experimental data and to choose a model that generates results, e.g., K-values or whatever is consistent with the experimental work. The comparison helps to decide whether the model is good or whether another type would be more suitable. Simulation programs have in-built proper packages that provide accurate thermodynamic physical and transport property predictions for hydrocarbons, non-hydrocarbon, petrochemical and chemical fluids. Many of these simulation programs have databases of over 1,500 components and over 10,000 of fitted binary

coefficients. If a library component cannot be found within the database, as an added feature, the software programs provide a comprehensive selection of estimation methods for creating fully dependent hypothetical compounds (e.g., pseudo-hydrocarbon components of crude oil for determining the true boiling point (TBP) of crude oil). They contain a regression package with the feature. Experimental pure component data, which the programs provide for over 1,000 components can be used as input to the regression package. Alternatively, the designers can supplement the existing data or supply a set of their own data. The regression package will fit the input data to one of the mathematical expressions, and thus allows the designers to obtain simulation results for specific thermophysical properties that closely match their experimental data.

Selecting the correct thermodynamic models from the property packages in the simulation programs (e.g., UniSim, Hysys, Aspen, ChemCad, Pro/II, ProSim, etc.) enables the designer to predict properties of mixtures ranging from well-defined light hydrocarbon systems to complex oil mixtures and highly non-ideal (non-electrolytic) chemical systems. Proper use of thermodynamic property package parameters results in successfully simulating any chemical process as the effects of pressure and temperature can drastically alter the accuracy of a simulation yielding missing parameters or parameters fitted for different conditions.

The thermodynamic models used to predict the chemical interaction properties, e.g., activity coefficients, volume and enthalpy of mixing, excess entropy of mixing, and K-values are the NRTL, Wilson, SRK, UNIQUAC, and UNIFAC models \S . These are incorporated in various simulation packages, e.g. Pro II,

HYSYS, Aspen Plus, ProSim Plus, ChemCad and UniSim (Honeywell).

It is essential to select an appropriate thermodynamic model, otherwise erroneous results on the simulation of any process will occur, and the procedure for selection as illustrated by Seader and Henley [36] is as follows:

\S RK = Redlich-Kwong
 PR = Peng Robinson
 SRK/RSK = Soave Redlich Kwong
 NRTL = Non-random two-liquid
 UNIQUAC = Universal quasichemical
 UNIFAC = UNIQUAC Functional group activity

1. Characterize the mixture by chemical types present: Light gases (LG), Hydrocarbons (HC), Polar organic compounds (PC), and aqueous solutions (A), with or without Electrolytes (E).
2. If the mixture is (A) with no (PC), then if electrolytes are present, select the modified NRTL equation. Otherwise, select a special model, such as one for sour water (containing NH_3 , H_2S , CO_2 , etc.) or aqueous amine solutions.
3. If the mixture contains (HC), with or without (LG), covering a wide boiling range, choose the corresponding states method of Lee-Kessler-Plöcker. If the boiling range of a mixture of (HC) is not wide boiling, the selection depends on the pressure and temperature.
4. For all temperatures and pressures, the Peng-Robinson (PR) equation is suitable.
5. For all pressures and non-cryogenic temperatures, the Soave-Redlich-Kwong (SRK/RSK) equation is recommended.

Stream Name	Raw Crude	Vapor Phase	Liquid Phase
Vapor Phase Fraction	0.278	0.278	0.228
Temperature [°C]	232.2	232.2	232.2
Pressure [kPa]	517.1	517.1	517.1
Mass Flow [kg/h]	2628	784.5	2042
Enthalpy [kJ/h]	5.62e+09	6.94e+08	5.13e+09
Entropy [kJ/h-K]	462.4	96.47	307.5
Heat Flow [kJ/h]	-3.44e+09	-1.25e+09	-4.27e+09
Heat Flow [kJ/h]	568.9	207.2	643.3
Heat Flow [kJ/h]	9.74e+08	-1.03e+09	6.22e+08
Heat Flow [kJ/h]	568.9	94.08	574.4
Fluid Package	Base 1	Base 1	Base 1
Phase Option	M-Alpha	M-Alpha	M-Alpha

Figure 4.24 Snapshot of the raw crude, vapor and liquid phases from Honeywell UniSim Design Suite software, (Courtesy of Honeywell Process Solutions, Calgary, Alberta, Canada), Honeywell (R) and UniSim (R) are registered trademarks of Honeywell International Inc.

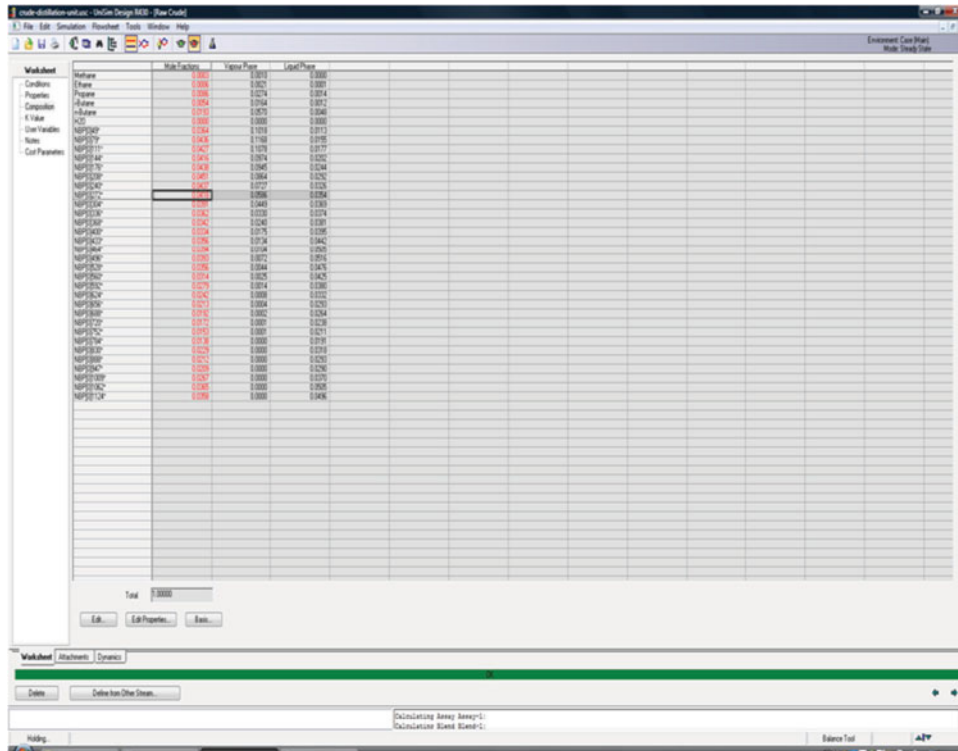


Figure 4.25 Snap-shot of compositions of the raw crude and petroleum fractions from Honeywell UniSim Design Suite software, (Courtesy of Honeywell Process Solutions, Calgary, Alberta, Canada), Honeywell (R) and UniSim (R) are registered trademarks of Honeywell International Inc.

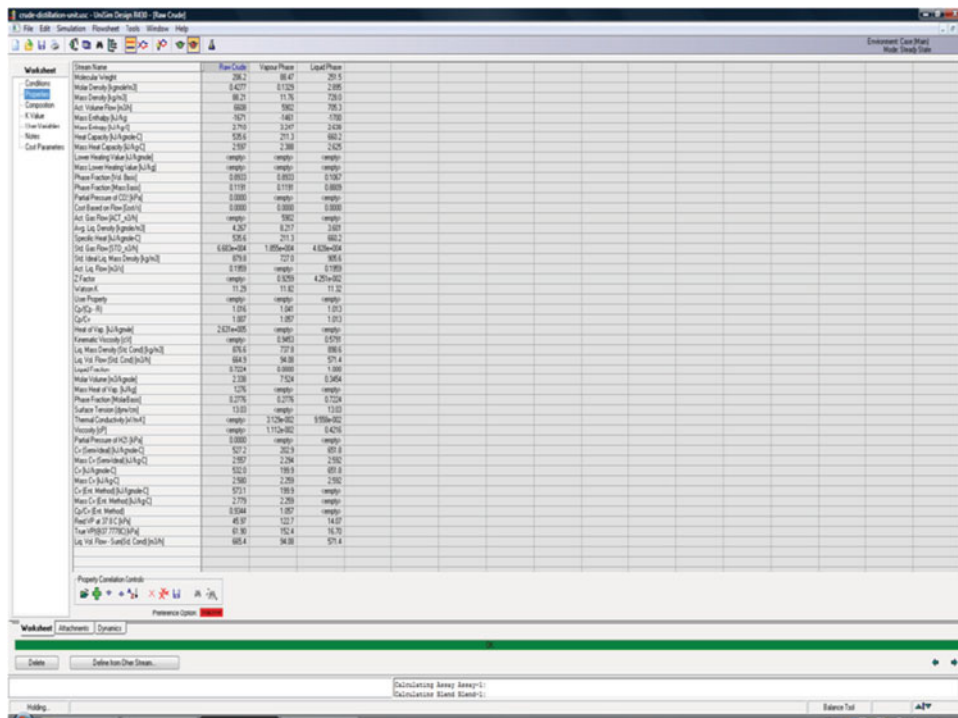


Figure 4.26 Snap-shot of Thermodynamic physical properties compositions of the raw crude liquid and vapor phases from Honeywell UniSim Design Suite software, (Courtesy of Honeywell Process Solutions, Calgary, Alberta, Canada Honeywell (R) and UniSim (R) are registered trademarks of Honeywell International Inc.).

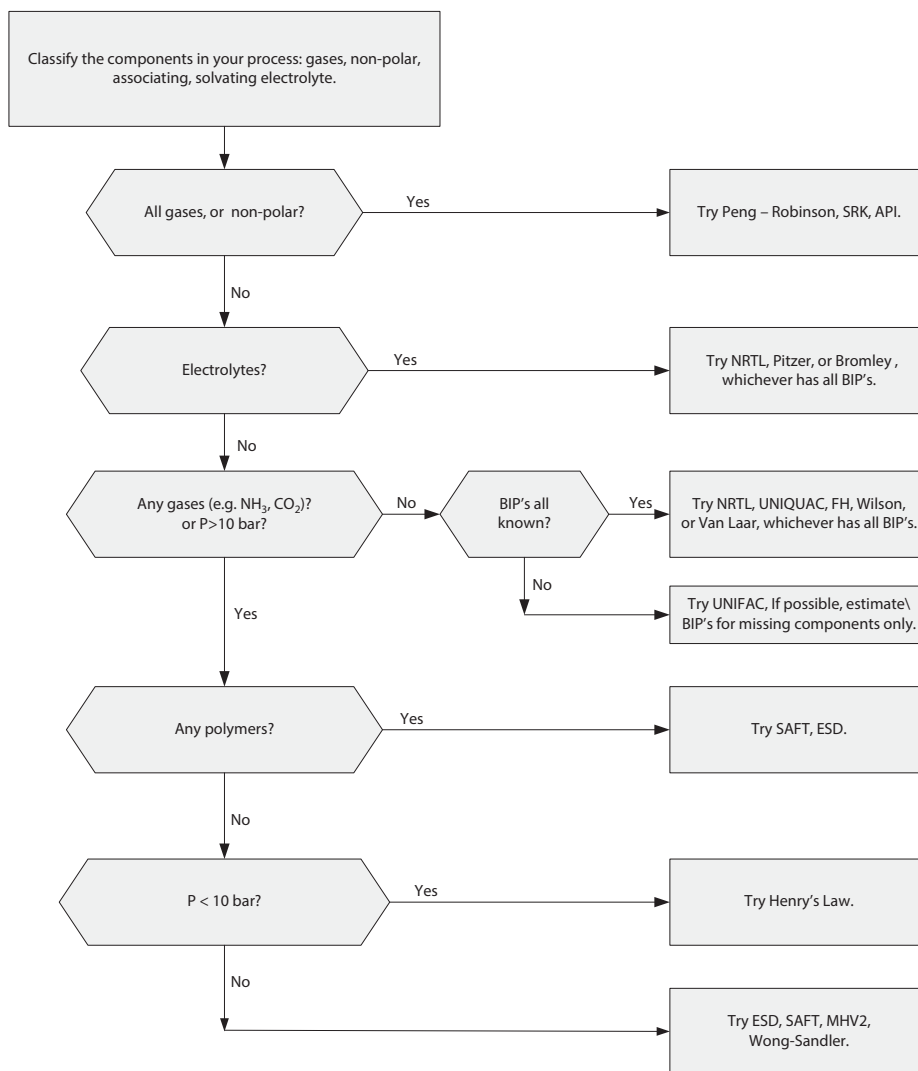


Figure 4.27 Flow chart to select the best thermodynamic model. The abbreviation BIP is used to mean binary interaction parameters (Source: Elliot, J.R., and Carl, T. Lira, Introductory Chemical Engineering Thermodynamics, Prentice Hall Int. Series, 1999).

Table 4.16 Approximate guides for selection of K-values methods

Chemical systems	
Low MW Alcohol and Hydrocarbons	Wilson
Higher MW Alcohol and Hydrocarbons	NRTL
Hydrogen Bonding Systems	Margules
Liquid-Liquid Equilibrium	NRTL/UNIQUAC
Water as a Second Liquid Phase	NRTL
Components in a Homologous Family	UNIQUAC
Low Pressure Systems with Associating Vapor Phase	
Light Hydrocarbon and Oil Systems	
Natural Gas Systems w/sweet and sour gas	SRK/PR
Cryogenic Systems	SRK/PR
Refinery Mixtures with p < 5000 psia	SRK/PR
Hydrotreaters and Reformers	Grayson-Stread
Simple Paraffinic Systems	SRK/PR
Heavy Components w/NBP > 1,000 °F	BK10

Table 4.16 Cont.

Based on polarity and ideality		
nonpolar - nonpolar	ideal & non-ideal	any activity coefficient model
nonpolar - weakly polar	ideal	any activity coefficient model
nonpolar - weakly polar	non-ideal	UNIQUAC
nonpolar - strongly polar	ideal	UNIQUAC
nonpolar - strongly polar	non-ideal	Wilson
weakly polar - weakly polar	ideal	NRTL
weakly polar - weakly polar	non-ideal	UNIQUAC
weakly polar - strongly polar	ideal	NRTL
weakly polar - strongly polar	non-ideal	UNIQUAC
strongly polar - strongly polar	ideal	UNIQUAC
strongly polar - strongly polar	non-ideal	NO RECOMMENDATION
aqueous - strongly polar		UNIQUAC

Key: NRTL = Non-random two liquid model; SRK = Soave-Redlich-Kwong; PR = Peng-Robinson, BK10 = Braun K10 for petroleum; UNIQUAC = universal quasi-chemical theory.

(Source: Wankat, P. C., *Separation Process Engineering*, 2nd ed., Prentice-Hall, 2007).

Table 4.17 Typical systems and recommended correlations.

Type of system	Recommended property package
Air Separation	PR, PRSV
Atm. Crude Towers	PR, PR Options, GS
Chemical Systems	Activity Models, PRSV
Cryogenic Gas Processing	PR, PRSV
Ethylene Towers	Lee Kesler Plocker
HF Alkylation	PRSV, NRTL
High H ₂ Systems	PR, ZJ or GS
Hydrate Inhibition	PR
Reservoir Systems	PR, PR Options
Sour Water	PR, Sour PR
Steam Systems	Steam Package, CS or GS
TEG Dehydration	PR
TEG Dehydration with Aromatics	PR
Vacuum Towers	PR, PR Options, GS < 10 mm Hg, Braun K10, Esso K

6. For all temperatures, but not pressures in the critical region, the Benedict-Webb-Rubin-Starling method is suitable.
7. If the mixture contains (PC), the selection depends on whether (LG) are present. If they are, the Predict Soave-Redlich-Kwong (PSRK) model is recommended. If not, then a suitable liquid-phase activity coefficient method is chosen.
8. If the binary interaction coefficients are not available, select the UNIFAC method. This should be considered as only a first approximation.
9. If the binary interaction coefficients are available and splitting in two liquid phases will not occur, select the Wilson or NRTL equation.
10. If phase splitting is probable, select the NRTL or UNIQUAC model.

Figures 4.24, 4.25 and 4.26 show snapshots of feed and product conditions, compositions of the feed and petroleum fractions, and calculated thermodynamic properties. Figure 4.27 [37] shows the flow chart to select the best thermodynamic model; Table 4.16 shows the conditions of some of these models, and Table 4.17 lists some typical systems and recommended correlations.

References

- Natural Gasoline Supply Men's Association, *Engineering Data Book*, 7th Ed. 1957, Tulsa, Oklahoma.
- Gas Processors Suppliers Association; *Engineering Data Book*, V 1 and 2, 3rd, rev., 9th ed. (1977), produced in cooperation with the Gas Processors Association.
- Haddad, H. N., and D. B. Manley, "Improve crude oil fractionation by distributed distillation", *Hydrocarbon Processing*, pp 93–108, May, 2008.
- DePriester, C. L., The American Institute of Chemical Engineers; *Chem. Eng. Prog. Sym. Ser.*: V. 49, No.7, p. 1, 1953.
- Perry, R. H., Don Green, and J. O. Maloney, *Perry's Chemical Engineering Handbook*, 7th, McGraw-Hill, Book Co. (1999).
- Smith, J. M., Van Ness, H. C. and M. M. Abbott, *Introduction to Chemical Engineering Thermodynamics*, 7th ed., McGraw-Hill Int. (2005)
- McWilliams, M. L., "An Equation to Relate K-factors to Pressure and Temperature", *Chem. Engineering*, 80 (25), 138, Oct. 29 (1973).
- Prausnitz, J. M., *Molecular Thermodynamics of Fluid Phase Equilibria*, Prentice-Hall (1969).
- Redlich, O., and J. N. S. Kwong, *Chem. Rev.*, V. 44, p. 233 (1949).
- Chueh, P. L., and J. M. Prausnitz, *I.&E.C. Fundamentals*, Amer. Chem. Society, V. 6, p. 492 (1967).
- Palmer, D. A., "Predicting Equilibrium Relationships for Maverick Mixtures," *Chem. Eng.*, p. 80, June 9 (1975).
- Prausnitz, J. M., *Molecular Thermodynamics of Fluid Phase Equilibria*,
- Prentice-Hall, 1969.
- Redlich, O., and A. T. Kister, *Ind. Eng. Chem.*, V. 40, p. 345, 1948.
- Redlich, O., T. Kister, and C. E. Turnquist, *Chem. Engr. Progr. Sym. Ser.*, 48, 2, p. 49, 1952.
- Wilson, G. M., *J. Am. Chem. Soc.*, V. 86, p. 127, 1964.
- Renon, H., and J. M. Prausnitz, *AIChE. Jour.* V. 14, p.135, 1968.
- Pitzer, K. S., D. Z. Lippman, R. F. Curl, Jr., C. M. Huggins, and D. E. Petersen, *J. Am. Chem. Soc.*, 77, 3433–3340, 1955.
- Poling, B. E., J. M. Prausnitz, and J. P. O'Connell, *The Properties of Gases and Liquids*, 5th ed., McGraw-Hill, New York, 2001.
- Shah, K. K. and G. Thodos, *Ind. Eng. Chem.*, 57 (3), 30–37, 1965.
- DeDoes, A. J., Goetz, M. D. and M. J. Misovich, "A Simple Approach to Vapor Pressure Prediction", *AIChE., CEP*, pp 39–44, January, 2007.
- Reid, R. C., Prausnitz, J. M. and B. E., Poling, *The Properties of Gases and Liquids*, 3rd Ed., McGraw-Hill, New York, 1977, Reid, et al. 4th ed., McGraw-Hill, New York, 1987.
- Walas, S. M., *Phase Equilibria in Chemical Engineering*, Butterworths Publishers, Boston, 1985.
- Smith, J. M., Van Ness, H. C., and M. M., Abbott, *Introduction to Chemical Engineering Thermodynamics*, 7th ed., McGraw-Hill Int. 2005.
- Doherty, M. F., and M. F. Malone, *Conceptual Design of Distillation Systems*, McGraw-Hill, New York, 2001.
- API data book procedure 11A1.1.
- ASTM specification D-2161.
- API data book procedure 11A1.4.
- Maxwell, J. B., "Crude Oil Viscosity Curves", *Data Book on Hydrocarbon*, D. Van Nostrand, Princeton, NJ, Sec. 9, pp. 15–65, 1957.
- American Standard Testing Methods, (ASTM), ASTM-IP Petroleum Measurement Tables and Standard Testing Methods, ASTM, Washington DC, 1952.
- Pedersen, K.S., Fredenslund, A., and P. Rasmussen, *Properties of Oils and Natural Gases*, Chapter 7, Gulf Publishing Company, Houston, TX, 1989.
- Gas Processors Suppliers Association (GPSA), "Physical Properties", *Engineering Data Book*, 9th ed., GPSA, Tulsa, OK, Figures 16–25 and 16–26, 1972.
- API, Technical Data Book, Method 4A1.1, Critical Temperature; Table 4A1.1
- Lee, B. I., and M. G. Kessler, "Improve prediction of enthalpy of fractions", *Hydrocarbon Processing*, 55, pp 153–158, 1976.
- Riazi, M. R., and T. A. Al-Sahhaf, "Physical properties of heavy petroleum fractions and crude oils". *Fluid Phase Equilib.*, 117, pp 217–224, 1996.
- Smith, J. M., Van Ness, H. C., and M. M. Abbott, *Introduction to Chemical Engineering Thermodynamics*, 7th Ed., McGraw-Hill Int. 2005.
- Seader, J. D., and Ernest J. Henley, *Separation Process Principles*, 2nd ed., John Wiley & Sons Inc. 2006.
- Standing, M. B., and D. L. Katz, "Density of Natural Gases", *Trans. AIME*, Vol. 146, pp 140–149, 1942.
- El-Gassier, M. M., "Fortran Programs Computes Gas Compression", *Oil Gas J.*, pp. 88, July 13, 1987.
- Gopal, V. N., "Gas Z Factor Equations Developed for Computer", *Oil Gas J.*, pp. 59, Aug. 8, 1977.
- Takacs, G. "Comparing Methods for Calculating Z-factor", *Oil Gas J.*, pp 43–46, May 15, 1989.
- Awoseyin, R. S., "Programs Integrate Pressure Loss for Single and Two-Phase Pipelines", *Oil Gas J.*, p 33, June 23, 1986.
- Cutlip, M. B., and M. Shacham, *Problem Solving in Chemical Engineering with Numerical Methods*, Prentice-Hall, Upper Saddle River, NJ, 1999.
- Kay, W. B., *Ind. Eng. Chem.*, Vol. 28, p. 1014, 1936.
- Felder, R. M., and R. W. Rousseau, *Elementary Principles of Chemical Processes*, 3rd ed., John Wiley & Sons, Inc. 2000.
- Himmelblau, D. M., *Basic Principles and Calculations in Chemical Engineering*, 6th ed., Prentice-Hall Int. Series, 1996.

5

Process Descriptions of Refinery Processes

5.1 Introduction

The raw material in the petroleum industry is crude oil, which comprises mainly a variable and complex mixture of hydrocarbons and substituted hydrocarbons containing different numbers of atoms of hydrogen and carbon.

The purpose of a refinery is to:

- Separate the crude oil into different “fractions” or saleable components.
- Shift the original component ratio and properties to meet the customer’s demand and
- Remove the impurities detrimental to product quality.

The products of refining are “fractions” of crude oil, which contain a large number of individual hydrocarbons; e.g., liquefied petroleum gases (LPG), petrol (gasoline) and lubricants. Further processing of these fractions yields petrochemicals, which contain a smaller number (one or two) of specific hydrocarbons of high purity, e.g., ethylene, and toluene. More complicated petroleum chemicals may then be made from

these feedstocks at another facility, which are often located near to or adjoining the refinery.

The processing of crude oil is extremely complex due to its numerous and varied components and the range of products that are derived from it. Figure 5.1 shows the basic refinery operations and the general processing.

The essential method of separating crude oil is distillation or fractionation, and the products are compared with each other in the order of their boiling point ranges. The products by distillation are referred to as raw products, which are unsalable, unless they are further refined. The raw gasoline and naphtha are often treated with chemical agents such as caustic soda (NaOH), copper chloride (CuCl_2) or doctor solution. Much of the naphtha is now catalytically reformed into high-octane gasoline.

In the topping unit, oil is pumped continuously through the heat exchanger system via the tube still into the vaporizer section of the multiple-draw fractionating tower. In this instance, the temperature must be sufficiently high to cause vaporization of all the products that are collected at points above the vaporizer, and the temperature may be a little higher so that

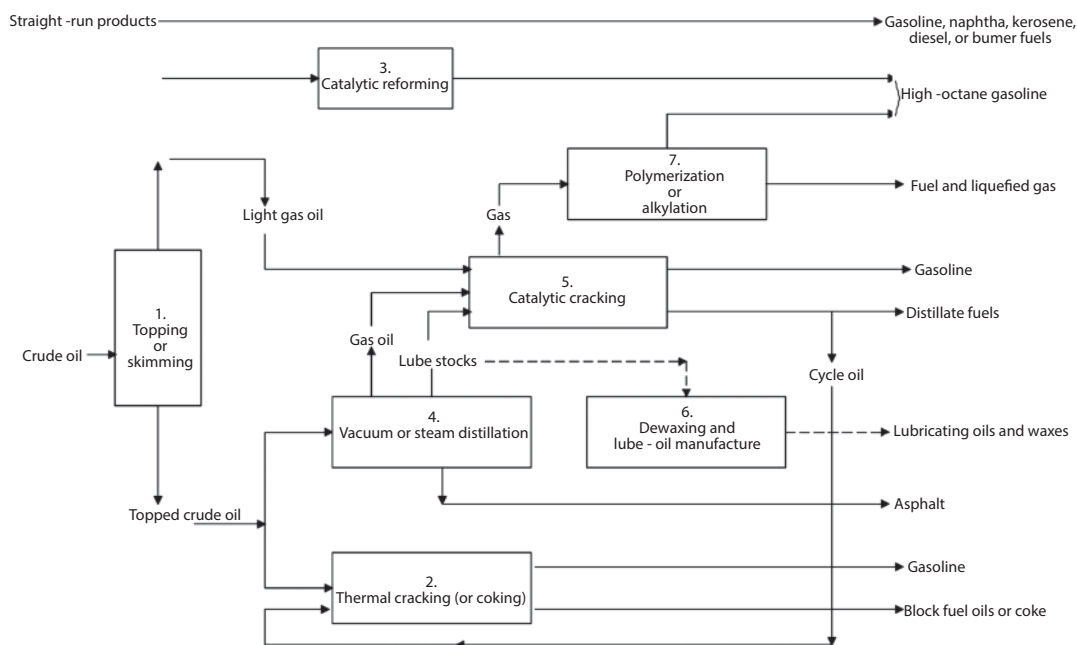


Figure 5.1 Basic refinery operations of topping, vacuum distillation, thermal cracking, catalytic reforming and catalytic cracking.

20% of the bottoms stock is vaporized. The purpose of the additional vaporization is to ensure that better fractionation takes place.

Kerosene usually requires only a sweetening treatment; however, fine colors, acid treatment or filtration is used as illustrated in Figure 5.2. Diesel fuels, distillate fuels, gas oil, and residual fuel oils are usually sold without treatment. Pressure distillate (i.e., high pressures that are usually maintained in the cracking equipment), or cracked gasoline obtained by cracking or thermal decomposition is sweetened, and an inhibitor of gum formation is added. Natural gasoline obtained from natural gas requires only sweetening treatment for the removal of hydrogen sulfide (H_2S) and mercaptan (RSH , where $R = C_n H_{2n+1}$, $n=1, 2$, etc.) compounds.

Wax distillate, which is the raw stock for the manufacture of the light lubricating oils or neutral oil-blending stocks, contains crystalline wax. The wax is removed by chilling the distillate and filtering the wax from the oil in filter presses (Figure 5.2c). The slack wax and pressed distillate, which are unfinished stocks, are obtained in the pressing operation. Natural oils (i.e., pale or red oils) are produced from the pressed distillate by distillation and subsequent filtration, and the crude scale, which is slightly yellow in color, is produced from the slack wax by "sweetening" or by slowly warming the chilled slack wax such that the oil and low-melting materials, which together are called foot oil, melt and drain from the slack wax. The

crude scale coloration can be removed by treatment with acid or caustic or by filtering the melted wax through clay.

Cylinder stock is a wax-bearing product; however, it cannot be filtered from the oil in wax presses. The petrolatum stock may be removed by dissolving the oil in naphtha, filtering the solution to a proper color through fuller's earth, and centrifuging the chilled solution in high-speed centrifuges. The products from this separation are solutions of bright stock and petrolatum. The naphtha is removed from the solutions by distillation, leaving finished bright stock and petrolatum.

Materials such as cracking-still gas, pressure distillate, cracked gas oil and pressure-still tars are products of cracking. Cracking is the decomposition of heavy or high-boiling oils by exposure to extreme temperature. At temperature, exceeding about $860^\circ F$ ($460^\circ C$) materials such as gas oil, fuel oil and tars are decomposed into (a) gas, (b) volatile materials (pressure distillate) having the same boiling point range as gasoline, and (c) a residue of heavy material (e.g., cracked fuel oil) or coke. Cracked gasoline from pressure distillate is valuable as an ingredient of the superior antiknock motor fuels.

Recycle stock or cracked gas oil, an intermediate between the two foregoing products is produced. It has about the same boiling point range and somewhat the same physical characteristics as gas oil. This material is

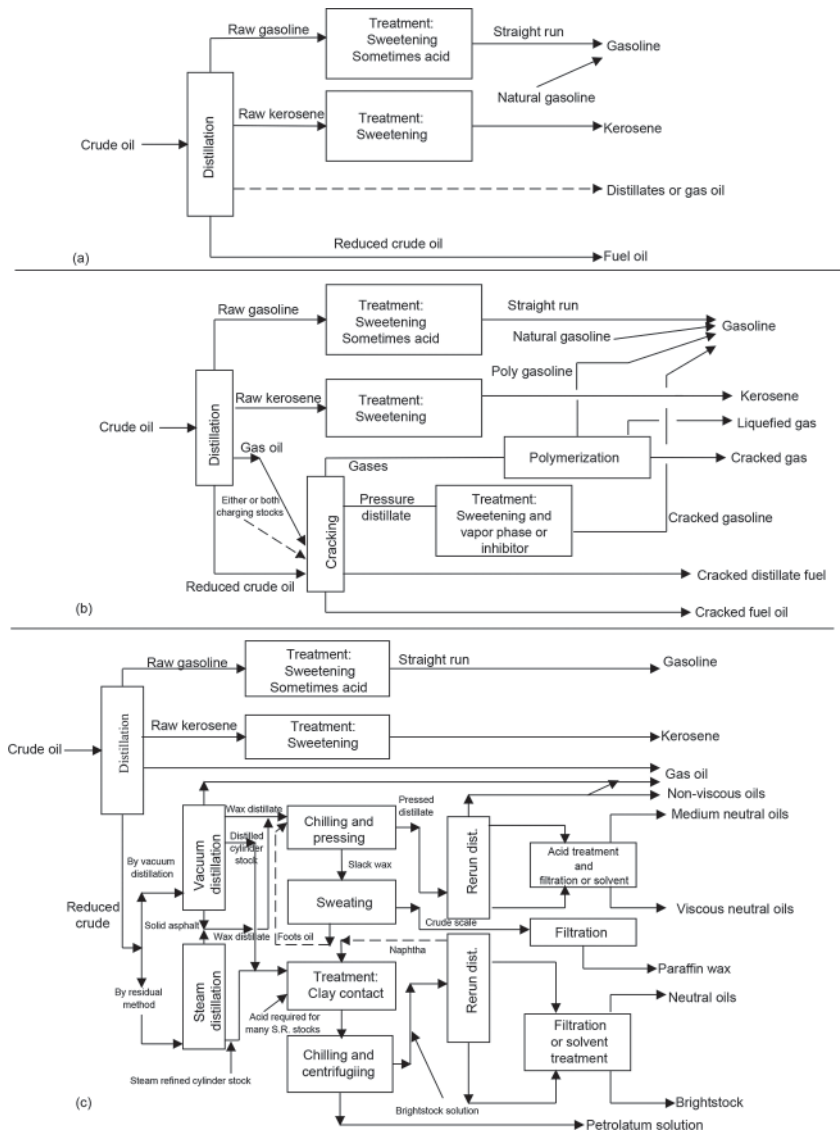


Figure 5.2 Types of refinery processin. (a) Topping or skimming processing (catalytic reforming), (b) Cracking processing (vacuum distillation and catalytic cracking) and (c). Lubricating oil processing (solvent treating and dewaxing).

normally recycled through the cracking system until it is completely converted to gasoline, although a part is sometimes sold as gas oil or distillate.

Thermal cracking and catalytic cracking are well-established processing operations; however, the latter differs from thermal cracking mainly in the introduction of an adsorbent-type catalyst which holds the asphaltic and tar-like products of cracking on the surface of the catalyst in the form of coke. Only distilled charging stocks are introduced, and Figure 5.1 illustrates the relationship of catalytic cracking to the operations as described and Tables 5.1 shows the refinery products.

Some unit processes are common to all refineries, e.g., primary distillation, but in general a refinery is made up of a selection of unit processes, such that each refinery has a different make-up to suit its specific requirement, which depends on the composition of the crude and the products required from it.

The demand for crude oil is often market-driven, as recently demonstrated by the world economic recession, in which the price of crude oil fell drastically from U.S. \$140 to \$36/barrel by the end of 2015. Crude oil distillation is a large energy consumer and a large waste generator. Refiners would require balancing the economics of processing crude oil to viable fractions

Table 5.1 shows the basic refinery products [1].

Products	Description
1. Natural and refinery gas	Household and industrial fuel.
2. Gasoline	Fuel for internal combustion engines.
3. Naphtha and benzene	Cleaner's solvent, paint thinners, chemical solvents and stocks for the blending of motor fuels.
4. Jet fuel	Fuel for jet or gas turbine engines, and for rockets.
5. Kerosene	Burning oil for household lamps.
6. Distillates, diesel fuel and gas oil (distillate products)	Fuels for industrial and household furnaces, enriching agents in gas manufacture, absorbents for hydrocarbon gases and fuels for diesel engines.
7. Neutral oils	Light or low-viscosity lubricating-oil stocks for the compounding of motor oils and light machine oils.
8. Bright stock	Heavy or high-viscosity lubricating oil stocks for the compounding of motor oils.
9. Cylinder oils	Unfinished heavy-oil stocks used directly as lubricants for steam-engine cylinders or for the manufacture of bright stock. Usually filtered but not dewaxed.
10. Paraffin wax	Used for the manufacture of wax paper, insulating material, package scaling, etc.
11. Petrolatum (microcrystalline wax)	Base material in the compounding of greases, salves, ointments, and package sealing.
12. Fuel oil (residual products)	Industrial fuel.
13. Tar and asphalt	Asphalt, road oil, roofing materials, and protecting coatings.
14. Petroleum coke	Solid industrial fuel.

(Source: Nelson, W. L., *Petroleum Refinery Engineering*, 4th ed., McGraw-Hill Series in Chemical Engineering, 1958).

such as gases (ethane, propane, butane, etc.), kerosenes, automotive fuels, heavy and light gas oils, etc. The principles of thermodynamics multicomponent distillation, as discussed earlier in the book, apply to petroleum, synthetic crude oil and other complex mixtures. Various advanced integrations and distributed distillation methods can be employed to minimize the economic cost of waste generation and thus optimize the performance of refining crude oil [2]. The processing of crude oil requires special consideration for the following reasons. The feedstocks are generally complex compositions, consisting of many different types of hydrocarbons and also inorganic and organic compounds. The number of carbon atoms in the components ranges from 1 to more than 50, so that the compounds may show atmospheric pressure boiling points from -260°F (-162°C) to more than 1000°F (538°C). Further in a given boiling range, the number of different compounds that shows only small differences in volatility increases very rapidly with a corresponding increase in boiling point, e.g., 16 of the 18 octane isomers boil within a range of only 22°F (12°C).

The fractionation products of these complex mixtures are often complex mixtures themselves; their character and yields vary widely, and often depend

upon the source of the feedstock. Crude oils from the same locality sometimes exhibit marked variations.

The scale of petroleum fractionation/distillation is generally large, involving atmospheric distillation of crude oil, vacuum distillation of bottoms residue obtained from atmospheric distillation, main fractionation of gaseous effluent from catalytic cracking of various petroleum fractions, and main distillation of effluent from thermal coking of various petroleum fractions. These operations are conducted in large equipment items that can consume large quantities of energy. Therefore, designers must seek ways of optimizing the design and operation of these processes, which often lead to complex equipment configuration. Figure 5.2 shows types of refinery processing and are briefly described as follows.

Skimming or Topping Processing (Figure 5.2a): This occurs by simple atmospheric -pressure distillation; the crude oil is separated into gasoline, kerosene and fuel oil, or reduced crude oil, and sometimes reformer charge stock, jet fuel or gas oil. Topping is often practiced on all types of crude oil.

Cracking Processing (Figure 5.2b): This refers to a combined operation of topping and thermal cracking; in most refinery facilities, the gas oil is catalytically

cracked. No lubricating oils are produced in this type of operation, and catalytic cracking yields smaller residual fuel oil.

Lubricating-oil Processing (Figure 5.2c): This process involves topping with the manufacture of lubricants from the residue of the crude oils. Paraffin-base crude oils are generally processed for lubricants, while mixed-base oils are often processed by solvent extraction in Figure 5.2c. Naphthalene oils are processed for lubricants only under the most favorable conditions. The operations of Figure 5.2c are now obsolete, as improved methods of refining crudes are further illustrated in this chapter. Modern refinery facilities conduct topping, viscosity breaking, thermal cracking, catalytic cracking, catalytic reforming, and lubricant manufacture simultaneously, and these operations are reviewed in this and subsequent chapter.

In general, crude oils vary widely in their properties as paraffin base raw products are the most easily treated, and the others follow in the order mixed-base and naphthalene-base. This applies to the light distillates such as gasoline and to the heavy lubricating oils. Naphthalene-base oils contain more sulfur than mixed-base oils, and paraffin-base oils may scarcely contain sulfur. Paraffin- and mixed-base crude oils contain wax, as compared to true naphthalene-base oils that contain no wax, which simplifies the manufacture of lubricants.

These characteristics provide the methods of processing that are employed for the different base of oils and the products that are manufactured. Paraffin-base oils are particularly adaptable for the manufacture of lubricating oils. However, the gasoline knocks terribly in modern automotive engines. Lubricating oils are produced from mixed-base oils, but acid and solvent treatment is usually necessary. Vacuum distillation or precipitation of asphalt by liquid propane is suited to the processing of mixed and naphthalene-base oils because most of the asphalt or tarry material may be left behind as a residue, and the cleaned lubricating-oil stocks can be treated more cheaply than asphalt-bearing stocks. Furthermore, naphthalene-base oils produce good asphalt and are usually in large quantities to justify their manufacture. The gasoline from naphthalene crude oils is usually antiknock and may be sold directly as premium-grade motor fuel. Figure 5.3 illustrates the boiling range of refinery products of Texas mixed-base crude oil at 31.7°API, and Figure 5.4 shows a schematic process flow diagram of a refinery facility for light oils, mainly gasoline, kerosene and distillates.

5.2 Refinery and Distillation Processes

All petroleum distillation/fractionation processes are generally the same, and it is essential that the chemical/process engineer has an adept working knowledge of the assigned process area and be familiar with the refinery layout and location of the major equipment. Further, he or she should have an operational knowledge of the refinery processes, utilities and distribution systems, feedstocks and products. Generally, all distillation processes require the following pertinent units of equipment: (1) Pipe stills or other heaters, (2) distillation/fractionating towers, (3) steam-stripping columns, (4) heat exchangers, (5) condensers and coolers, (6) pipelines, (7) compressors and pumps, (8) storage and accumulator tanks, (9) flare stacks, and (10) instrumentation (e.g., control valves for temperature, pressure, flow and level). Adapting these units of equipment to the processing of a particular stock requires many factors to be considered. Among the most important of these are:

- The boiling range of the stock.
- The stability of the stock with respect to heat.

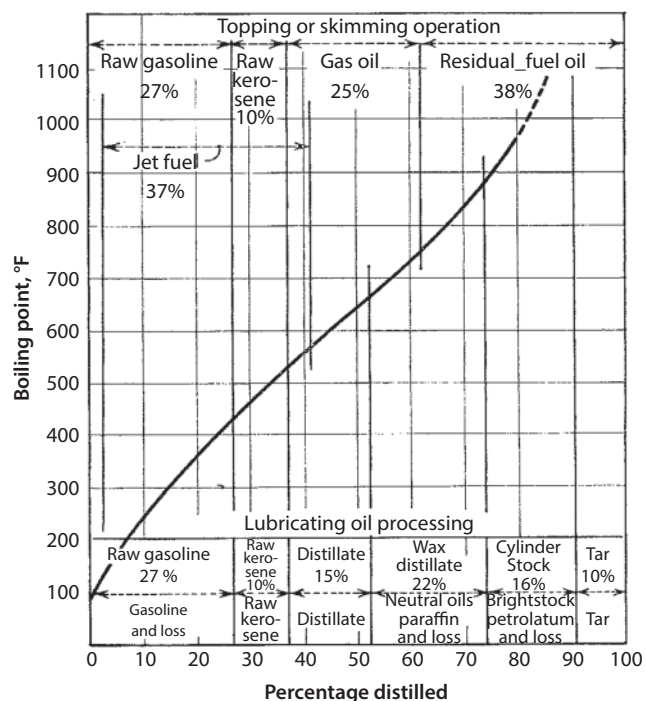


Figure 5.3 Boiling range of refinery products (31.7 °API Texas mixed-base crude oil) (Source: Nelson, W. L., *Petroleum Refinery Engineering*, 4th ed., McGraw-Hill Series in Chemical Engineering, 1958).

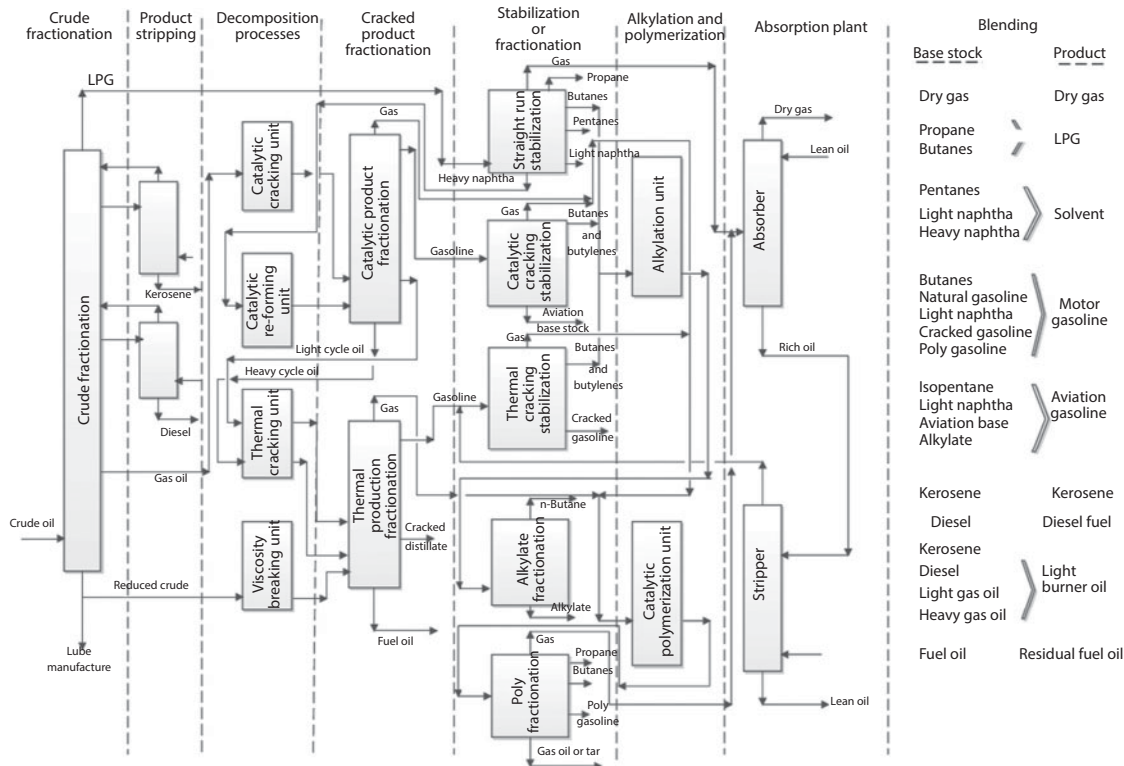


Figure 5.4 Flow diagram of a refinery facility for light oils (mainly gasoline, kerosene and distillates).

- The specifications of the products to be produced.

Figure 5.5 shows a process flow diagram of a refinery unit, involving three main processes as separation, conversion, and treating.

Figure 5.6 is a process flow diagram of a complex refinery unit involving further processing as crude product handling and auxiliary facilities. Here, the feed is Arabian light crude oil from tank farm, which is processed in the crude distillation unit. The first physical separation process produces distillate streams of Liquefied petroleum gas (LPG), naphtha, kerosene, light gas oil, heavy gas oil and long residue.

The hydrodesulfurizer units remove the sulfur components contained in the naphtha, kerosene and heavy gas oil. The high-vacuum unit (HVU) processes long residue, which comes from the mild-vacuum columns of the crude distillers. The main product is a waxy distillate which is used as feed to the hydrocracker unit (HCU). The unit also produces short residue and black wash oil to be used as feed-to the visbreaker unit (VBU).

The visbreaker unit processes the short residue from the HVU, alternatively, long residue from the crude

distillers. The resulting products are naphtha and gas oil, and the visbroken residue goes for blending either with kerosene or gas oil to be used as fuel oil.

The first section of hydrocracking unit consists of a hydrocracker and fractionating unit, sour gas and LPG treating units such as aqueous di-isopropanolamine (ADIP). The ADIP treating system consists of:

- ADIP Gas Absorption Systems.
- LPG ADIP Extraction Systems.
- ADIP Regeneration Section.

The hydrocracker takes a heavy waxy distillate feed from the high-vacuum unit (HVU) and converts it in the reactors by using a catalyst under highly exothermic reaction to LPG and light gases, naphtha, and kerosene and gas oil. The separation of the final products is achieved in the fractionating unit. Naphtha is sent to storage as platformer feed, while the kerosene is sent to storage together with the kerosene from the hydrodesulfurization unit of the crude distillation unit (CDU). Hydrocracker gas oil is also sent to storage with the gas oil from the hydrodesulfurization unit of the CDU. The LPG (gas and liquid) is treated in the ADIP unit before being pumped to LPG unit.

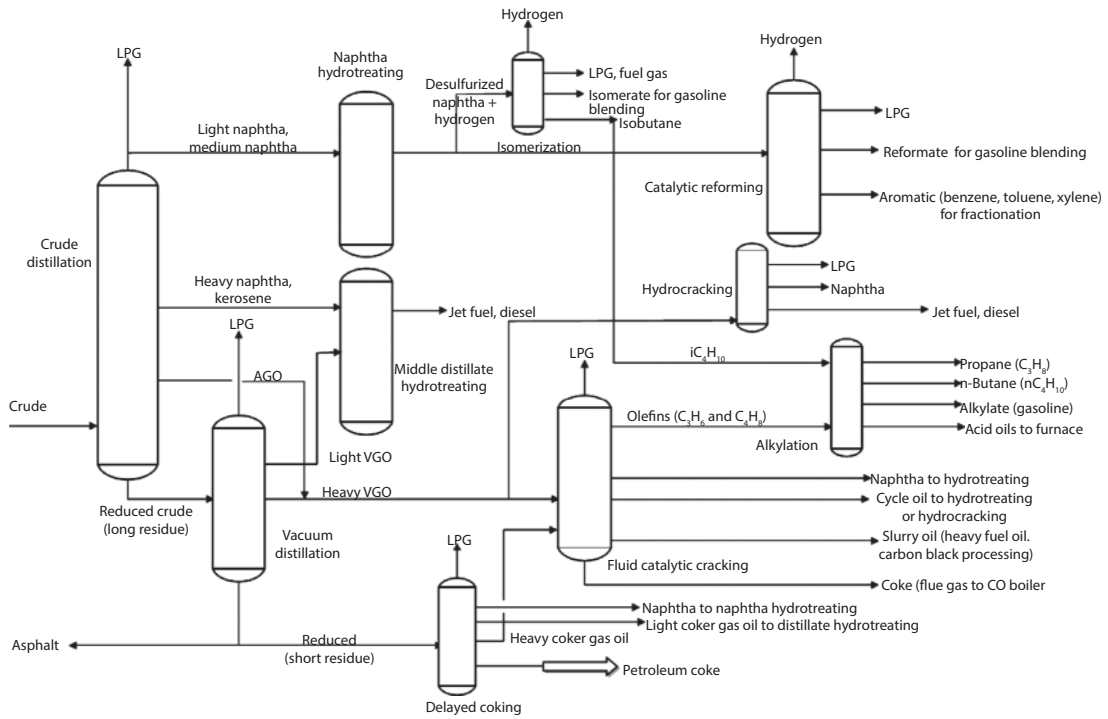


Figure 5.5 Process flow diagram of a refinery facility.

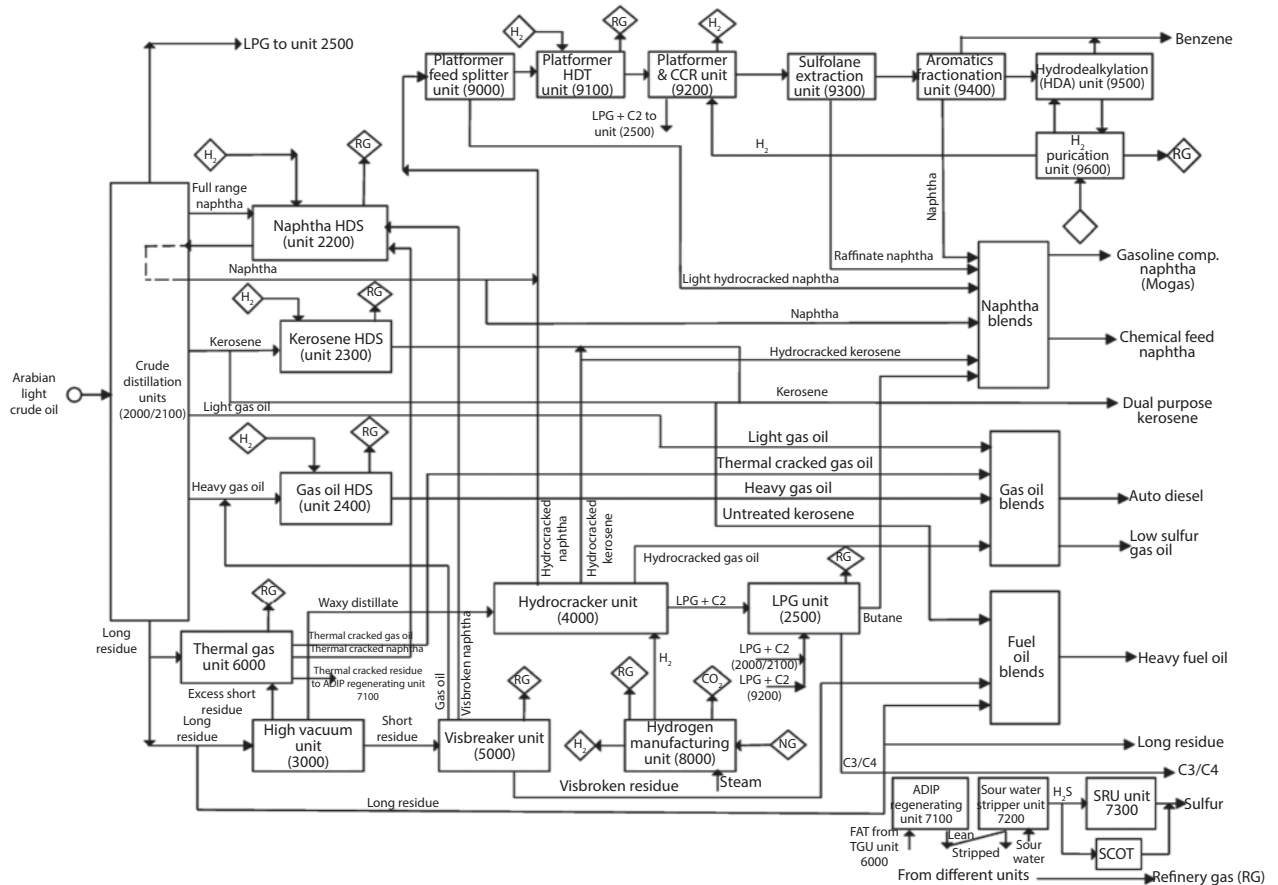


Figure 5.6 Overall flow diagram of a typical refinery facility.

The second section consists of hydrogen manufacturing unit (HMU), LPG unit, sour water strippers, regeneration units, sulfur recovery units (SRU). The HMU takes in natural gas (NG) as feed and converts it to produce high-purity hydrogen gas, which is then fed to the hydrocracker unit and other various units in the refinery that use hydrogen as feed in their processes. The LPG unit receives gas and liquid; the light gas is used as fuel for the refinery furnaces and the liquid is separated into two final products: LPG is pumped to another facility, and butane is added to chemical feed naphtha for KVP correction.

Sour water strippers collect water from all the other refinery units and remove the sour gases from it, which are mainly dissolved hydrogen sulfide (H_2S) and ammonia (NH_3). The cleaned up water is then pumped to utilities facility of the refinery for further treatment before being pumped for irrigation. The sour gas is fed to the sulfur recovery unit (SRU) where it is burnt in a series of furnaces, leaving the residual hot liquid sulfur that is then pumped to a gas plant facility.

The purpose of the platformer feed splitter unit is to separate the light ends from naphtha produced in the hydrocracker fractionation unit by distillation. This unit minimizes the size of the platformer hydrotreater unit by separating the light ends from naphtha feed. The light ends can then be used for blending into chemical feed naphtha or gasoline component after further treatment.

The heavy hydrocracked naphtha and the straight-run naphtha are further processed by removing sulfur and metals, which poison the platformer catalyst. The platformer processes hydrocracked naphtha from the hydrocracker unit or naphtha from the distillers and converts it to produce a single stream of mixed products known as the platformate. The naphtha is fractionated where heavy hydrocracked naphtha is split into a light and a heavy fraction. The heavy fraction hydrocracked naphtha is then treated in the platformer hydrotreater unit. The product is then fed to the Sulfolane extraction unit to separate aromatic from non-aromatic components. This unit is a separation process that employs an extractive solvent (Sulfolane) to separate aromatics (e.g. C_6H_6 , C_7H_8) from non-aromatics. The aromatics and non-aromatic mixture are from the platformer unit where aromatics are generated. The aromatics are then dissolved in Sulfolane, and the mixture becomes the extract phase (bottom), where the remaining non-aromatic stream forms the raffinate phase (tops). The Sulfolane is recovered from the raffinate first in a

coalescer and then in water wash column. The final raffinate is pumped to naphtha blending as gasoline components.

The aromatics extracted in the Sulfolane extraction unit are sent directly to the aromatics hydrodealkylation unit for conversion and fractionating/distillation unit to produce benzene. This unit has two distillation columns that produce benzene (C_6H_6), which acts as a feed for styrene manufacture in a petrochemical facility. The toluene (C_7H_8) and xylene (C_8H_{10}) stream is fed to the hydrodealkylation unit (HDU), and a C_{9+} heavy aromatic stream is fed for naphtha blending.

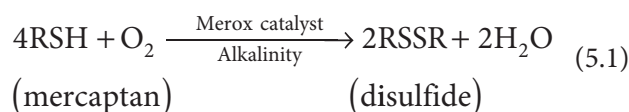
The hydrodealkylation unit (HDU) is designed to produce high-purity benzene by hydrodealkylation of toluene and xylene. The toluene and xylene feed stock is prepared by the platformer unit with Sulfolane extraction unit and subsequent distillation of the extract (e.g., the aromatics). The mixed aromatics and hydrogen at $650\text{ }^\circ\text{C}$ ($1202\text{ }^\circ\text{F}$) are fed to a reactor where the aromatics are dealkylated to form benzene (C_6H_6), methane (CH_4) and ethane (C_2H_6). The high-purity benzene is recovered from the reactor product mixture by distillation and sent to storage, and the unconverted aromatics are recycled to the feed. The platforming process, which takes place in the reactors, also produces hydrogen, which is exported to the refinery hydrogen main and combines with the hydrogen produced in the hydrogen manufacturing unit (HMU).

The hydrogen purification unit operates in conjunction with the HDU unit. The hydrogen purification unit removes C_{3+} material from the hydrogen makeup gas from the platformer unit and also recovers hydrogen and aromatics from the hydrodealkylation unit vent gas. The make-up gas from the platformer and the vent gas from the hydrodealkylation unit are pretreated prior to entering the cold box. Pretreatment prevents corrosion and freezing due to water and heavy hydrocarbons. The pretreated feed streams are increased in hydrogen content in the cold box by condensing out; separating and evaporating the hydrocarbons present (mainly methane).

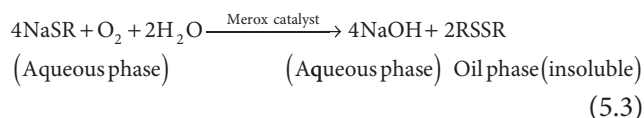
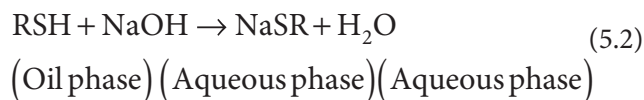
Benzene emission control unit is where benzene vent effluents from the Sulfolane extraction unit, aromatics fractionating unit and the hydrodealkylation unit respectively, and are washed in a column with heavy aromatics to absorb benzene before being released to the atmosphere through an active carbon bed that catches the last traces of the aromatics. Benzene vent effluents are from samples taken in these units, blanketing gas and intermittent benzene vent lines.

The MEROX (i.e., MERcaptan Oxidation) sweetening process is the conversion of mercaptans to disulfides. The treatment does not reduce the sulfur content of the stream. A number of finished petroleum products, notably gasolines, and kerosenes carry a mercaptan specification because of the slight toxicity and foul smell of these compounds. Disulfides are acceptable; however, hydrocarbon (tops) treater is intended to be used for the treatment of the amount of HC tops required for reformed naphtha blending. The process is based upon the ability of a catalyst (composed of iron group metal chelates) to promote the oxidation of mercaptans to disulfides using air as the source of oxygen.

The overall reaction is as follows:



The reaction is carried out in the presence of a strong alkali (usually sodium hydroxide) and proceeds in two steps, a mercaptan-extraction step is followed by oxidation of the extracted mercaptan. These steps are:



According to these treatment steps, the treated product has reduced sulfur content corresponding to the amount of mercaptan extracted. The oxidation reaction is irreversible, as it proceeds at an economically practical rate at a normal temperature for refinery run-down streams. The MEROX sweetening process can be carried out either in the liquid phase with a caustic dispersible catalyst or on a solid-suspended catalyst. The water-insoluble catalyst is deposited on a fixed bed of charcoal by circulating a slurry of catalyst in ammoniated water. The support has to be reimpregnated with fresh catalyst at certain time intervals (e.g., once a year depending on the utilization of the unit).

After further processing involving physical separation and chemical conversion, treatment and blending, the products are liquefied petroleum gas (LPG), chemical feed naphtha, gasoline component naphtha (Mogas), dual purpose kerosene (DPK), auto diesel, low sulfur gas oil, heavy fuel oil, refinery gas, and

aromatics (C_6H_6), which are sent to the petrochemical unit for the production of styrene. An ultra-low-sulfur diesel (ULSD) facility produces Euro 5 Ultra-low sulfur (10 ppm) for the European market. Wash water is applied in the ULSD facility to prevent blockage of the reactor effluent air coolers, which is the downstream of the hydrodesulfurizer reactor (HDS). This blockage can occur due to the formation of ammonium bisulfide (NH_4HS) as a result of the high concentrations of H_2S and NH_3 in the reactor effluent. Effluent water from the ULSD unit is rich in H_2S and NH_3 and has to be processed in the Sour Water Stripper (SWS) unit for the removal of H_2S and NH_3 prior to recycling the water back to the quench column.

The Shell Claus Off-gas Treating (SCOT) facility is used to achieve a sulfur recovery level of (99.9%) such that the point-source emission from each sulfur stack meets the SO_2 specification set by environmental regulations. The sour water is water that is produced in process units due to use of water for scrubbing, quenching or as a stripping medium, where the water comes into direct contact with the process streams. The sour water leaving these process units is contaminated with dissolved gases (H_2S , NH_3) and emulsified hydrocarbons. These dissolved gases are required to be removed before the water can be reused in the process or sent to the effluent treatment plant, and this removal is carried out in the Sour Water Stripper (SWS). In the SCOT absorber, the H_2S component in the sulfur recovery unit (SRU) tail gas is absorbed by an amine solution and practically H_2S -free process gas (not more than 40 ppmv H_2S) is routed to catalytic incinerators. Due to the very stringent specification of SO_2 component in the sulfur stack, very deep removal of sulfur component is required. In order to achieve the target, a very low H_2S loading in lean solvent, such as methyldiethanolamine (MDEA) of 30% wt with a loading of 0.0004 moles H_2S /mol MDEA is recommended.

The cracked residue from the thermal gas unit is treated using aqueous diisopropanolamine (ADIP). The H_2S is treated in the sulfur recovery unit (SRU), initially applying sufficient air to convert H_2S to SO_2 , and further reaction between H_2S and SO_2 over a catalyst to product sulfur (S). Process descriptions of various processing units involving physical separation and chemical conversion, treatment and blending units in Figures 5.5 and 5.6 are illustrated in this and subsequent chapter.

Figure 5.7a is a photograph showing a refinery with distillation towers, piping and ancillary equipment,



Figure 5.7 (a) Photograph of a refinery with fractionating columns, associated piping and ancillary equipment. (b) Photograph of the naphtha stabilizer column equipped with two vertical reboilers in the crude distillation unit.

and Figure 5.7b is a photograph of the naphtha stabilizer column with two vertical reboilers in the crude distillation unit respectively. Table 5.2 summarizes the various processes in a typical refinery, and Table 5.3 shows products and their uses of a typical refinery.

5.3 Process Description of the Crude Distillation Unit

Crude oil distillation columns are in various sizes and the capacities for processing the feed range from 5,000

Table 5.2 Refinery processes.

Separation	Crude oil desalting/dewatering Atmospheric distillation Vacuum distillation Light ends recovery.
Conversion	Thermal cracking–coking, visbreaking Catalytic cracking Hydrocracking Steam cracking Catalytic reforming Isomerization Alkylation and polymerization.
Treating	Hydrodesulfurization Hydrotreating Extraction Bitumen blowing Lube oil manufacture (large or specialist refineries only).
Crude and product handling	Unloading Storage Blending Loading.
Auxiliary facilities	Boiling/process heaters Hydrogen production Sulfur recovery and production Cooling towers Compressor engines Power generation Blow down system Wastewater treatment Flares.

to 10,000 barrels per day (700 to 1,400 metric tons per day) to 400,000 barrels per day (56,000 metric tons per day). Process economics favors large units, and the separations achieved with crude columns are independent of size, and the strategies employed are common for all sizes.

The first stage in the processing of crude oil is referred to as crude distillation units (CDUs), crude topping units (CTUs), topping units, atmospheric crude distillation units, atmospheric pipe-stills, etc. The products at the top of the fractionating/distillation column are called the light gasoline. These are also referred to as light straight-run (LSR), light naphtha, etc. The heavy gasoline product is reformed to improve its octane and

Table 5.3 Typical refinery products.

Name/abbreviation	Major uses
Crude oil (Arab light)	To obtain various products, e.g., Liquefied Petroleum Gas (LPG), naphtha, gasoline, kerosene, diesel, fuel oil, tar and sulfur.
Natural gas (NG)	To produce hydrogen and various petrochemicals, e.g., methanol (CH ₃ OH), ethylene (C ₂ H ₄), ammonia (NH ₃), etc. As a heating source in boilers and furnaces. To drive gas turbines.
Liquefied Petroleum Gas (LPG)	Domestic use: for cooking and heating. Industrial use: to produce petrochemicals, intermediates and for blending in gasoline.
Chemical Feed Naphtha (CFN)	As feed to various petrochemicals and plastic industries (as an alternative to natural gas).
Motor Gasoline Component Naphtha (MGC)	Fuel for vehicles. For the manufacture of aviation gasoline, aromatics (e.g., Benzene C ₆ H ₆ , Toluene C ₇ H ₈), Xylene (C ₈ H ₁₀), i.e. BTX).
Dual Purpose Kerosene, illuminating kerosene, Jet Fuels (DPK, KERO, JET A1)	Domestic use—cooking, illuminating, heating, Jet aviation fuel, manufacturing detergents, paint thinner, carbon black, etc.
Auto Diesel Oil (ADO)/Gas oil (GO)	As a heating oil in cold countries, fuel for trucks, trains power generators.
Heavy Fuel Oil (HFO)	Fuel for ships, power generators, boilers and furnaces.
Sulfur (solid)	For the manufacture of fertilizers, match sticks, explosives, sulfuric acid (H ₂ SO ₄) and pharmaceuticals.
Benzene (C ₆ H ₆) pure aromatic compound.	For the manufacture of petrochemicals, e.g., styrene, pesticides, dye intermediates, detergents, resins, solvents.

may be called: naphtha, heavy naphtha, heavy gasoline, reforming naphtha, jet fuel (military JP-4), etc., depending on its end use. Light fuel distillate is most commonly called kerosene, or light distillate or jet fuel (commercial JET 50) and virgin distillate. The middle distillate is referred to as diesel fuel and light gas oil (LGO). The heaviest distillate is called atmospheric gas oil (AGO), heavy gas oil (HGO), heavy distillate gas oil, etc. The crude column bottoms product is referred to as reduced crude, long residue, topped crude oil, atmospheric residue, atmospheric bottoms, pipe-still bottoms, etc.

The CDU is accomplished in multi-draw columns (strippers) for which all the heat is supplied to the feed. The products are condensed and withdrawn as side products, as the hot vapor portion of the feed are contacted with colder liquid reflux flowing down the column. The reflux is provided at the top of the flask by pumping some of the condensed liquid back to the top tray (Figure 5.11a). The reflux is also provided at intermediate locations in the column with pump-around cooling circuits. The hot liquid portions of the crude oil feed are stripped with steam to remove dissolved light hydrocarbons before leaving the bottom of the column.

Figure 5.8 shows the crude fractionation unit in more detail with the pump-around. Cold crude oil from storage is pumped through a series of exchangers, where it is preheated by exchange with intermediate products from the crude and vacuum distillation columns.

Crude desalting is the first processing step in a refinery. This is carried out to remove the salts, suspended solids and water from the unrefined crude before introducing it to the crude distillation unit (CDU). Salt is present in the crude oil in the form of dissolved or suspended crystals in water that is emulsified with the crude oil. The desalting process washes the salt from crude oil with water. It can often be difficult to produce efficient and economical water/oil mixing, water wetting of suspended solids, and separation of oil from wash water. The separation of oil and wash water is affected by the specific gravity, viscosity and pH of the crude oil and the ratio of water/crude used for washing.

5.3.1 Crude Oil Desalting

Crude oil carries with it some brine in the form of very fine water droplets emulsified in the crude. The salt content of the crude measured in pounds per thousand

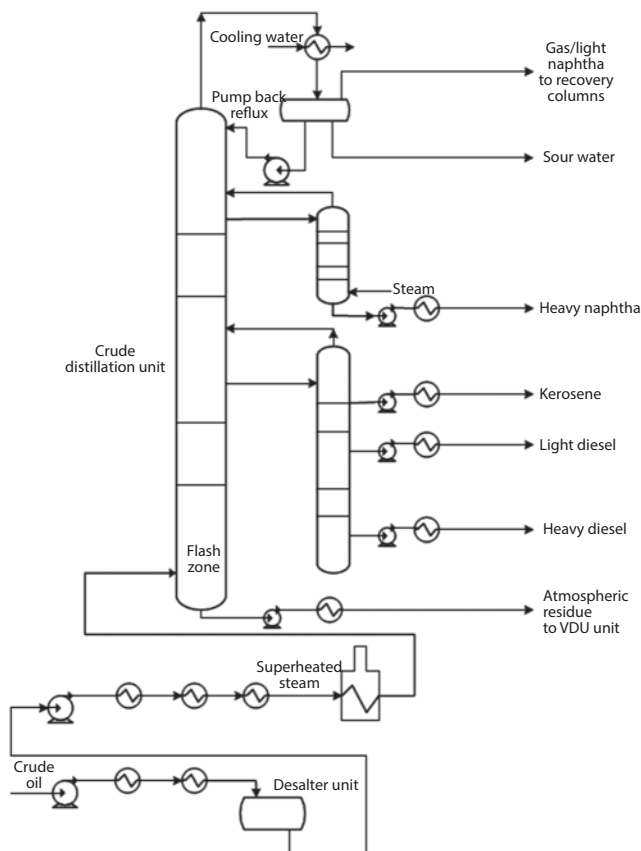


Figure 5.8 Atmospheric crude column with pumparound and pumparound reflux.

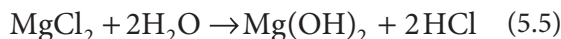
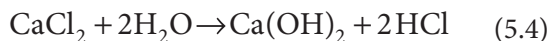
barrels (PTB) can be as high as 2000. Desalting of crude oil is an important part of the refinery operation as the salt content should be minimized to 5.7 and 14.3 kg/1000 m³ (i.e., 2 and 5 PTB). Poor desalting of the crude could adversely impact on the following:

- Corrosion of overhead equipment.
- Salt deposits inside the tubes of furnaces and tube bundles of heat exchangers. This causes fouling of the exchanger and thereby reducing the heat transfer efficiency.
- Salts are carried with the products and can poison the catalyst in the catalytic cracking unit.

5.3.2 Types of Salts in Crude Oil

Salts in the crude oil are mostly in the form of dissolved salts in fine water droplets emulsified in the crude. This is referred to as water-in-oil emulsion, where the continuous phase is the oil, and the dispersed phase is the water. The water droplets are relatively tiny such that

they cannot settle by gravity. These fine droplets have on their surfaces the big asphaltene molecules with the fine solid particles coming from sediments, sand or corrosion products. The presence of these molecules on the surface of the droplets acts as a protector that prevents the droplets from uniting with each other in what is referred to as coalescence. Furthermore, the salts can be in the form of crystals that are suspended in the crude. Removing the salts requires that they must be ionized in the water. Therefore, wash water is added to the crude to enhance the desalting process. The salt types are mostly magnesium chloride (MgCl₂), calcium chloride (CaCl₂) and sodium chloride (NaCl) with sodium chloride being the abundant type. These chlorides except NaCl hydrolyze at high temperatures to hydrogen chloride (HCl):



HCl dissolves in the overhead system water producing hydrochloric acid, which is extremely corrosive.

5.3.3 Desalting Process

The desalting process is accomplished through the following steps [3]:

Water washing: Water is mixed with the incoming crude oil through a mixing valve. The water dissolves salt crystals, and the mixing distributes the salts into the water, uniformly producing fine droplets. Demulsifying agents are added to break the emulsion by removing the asphaltenes from the surface of the droplets.

Heating: The crude oil temperature should be in the range of 120–130 °F (48.9–54.4 °C) since the water-oil separation is affected by the viscosity and density of the oil.

Coalescence: The water droplets are so fine in diameter in the range of 1–10 μm that they do not settle by gravity. Coalescence produces larger drops that can be settled by gravity. This is accomplished through electrostatic electric fields between two electrodes. The electric field ionizes the water droplets and orients them so that they are attracted to each other. Agitation is also produced and assists in coalescence. The force of attraction between the water droplets is given by:

$$F = KE^2 d^2 \left(\frac{d}{s} \right)^4 \quad (5.6)$$

where

- K = a constant
- E = Electric field
- d = drop diameter
- s = the distance between drops centers.

Settling: According to Stoke’s law, the settling rate of the water droplets after coalescence is:

$$\text{Settling rate} = \frac{k(\rho_{\text{H}_2\text{O}} - \rho_{\text{oil}})d^2}{\mu_{\text{oil}}} \quad (5.7)$$

where

- ρ = density
- μ = viscosity
- d = droplet diameter
- k = a constant

The crude oil is injected with five to six liquid volume percent water at a temperature 200–300 °F (93–149 °C). Both the ratio of water to oil and the operating conditions are functions of the specific gravity of the crude oil, and typical operating conditions are shown in Table 5.4. The salts are dissolved in the wash water; oil and water phases are separated in a settling vessel either by adding chemicals to aid in breaking up the emulsion or by the application of an electrostatic field to coalesce the droplets of salt water. Either an AC or DC field may be applied at potentials of 16,000–35,000 V. In the desalter, the salts (e.g., magnesium chlorides) selectively migrate to the aqueous phase which forms a brine solution at the bottom of the desalter while the crude oil that floats above forms a separate stream. Efficiencies up to 90–95% water removal are achieved in a single stage and up to 99% in a two-stage desalting process. Figure 5.9 shows an electric desalting method and Figure 5.10a shows an electrostatic desalter containing

Table 5.4 Atmospheric crude distillation column operating conditions.

Operating parameter	Units	Value
Temperature		
Transfer line	°F	660
Flash zone		657
Tower top		359
Kerosene draw-off		469
Pumparound draw off		548
Pumparound return		345
Light diesel draw off		603
Tower bottom		648
Pressure		
Reflux drum	psig	2.0
Tower top		10.3
Flash zone		14.7
Reflux ratio, reflux/Liq.dist.		0.6
Stripping Steam		
To Atmospheric tower	lbs/bbl Resid.	5.5
To Kerosene stripper	lbs/bbl Resid	5.9
To Diesel stripper	lbs/bbl Resid	2.1
Atmospheric Heater		
Process fluid conditions		
Temperature In	°F	453
Temperature Out	°F	660
Pressure drop	psi	138
Tube skin temperature (Avg.)	°F	735
Stack gas temperature	°F	725
Fractionation Efficiency		
5%-95% ASTM distribution gap		
Atmospheric Naphtha-Kerosene		Gap + 10
Kerosene-Light diesel		Gap - 36

Note: Basis 154000 bpsd Kuwait Crude Run.

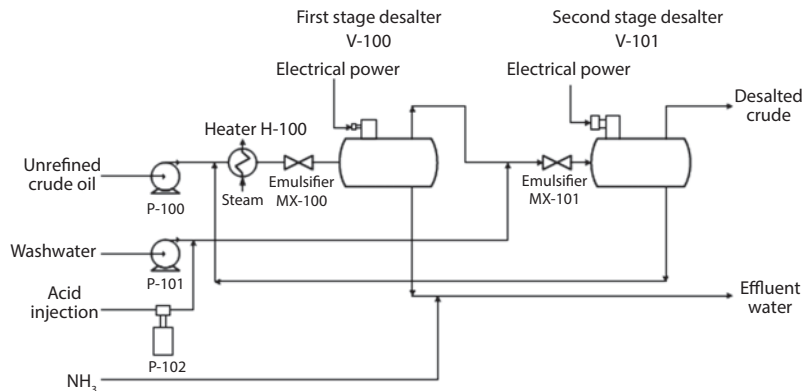


Figure 5.9 Two-stage desalter.

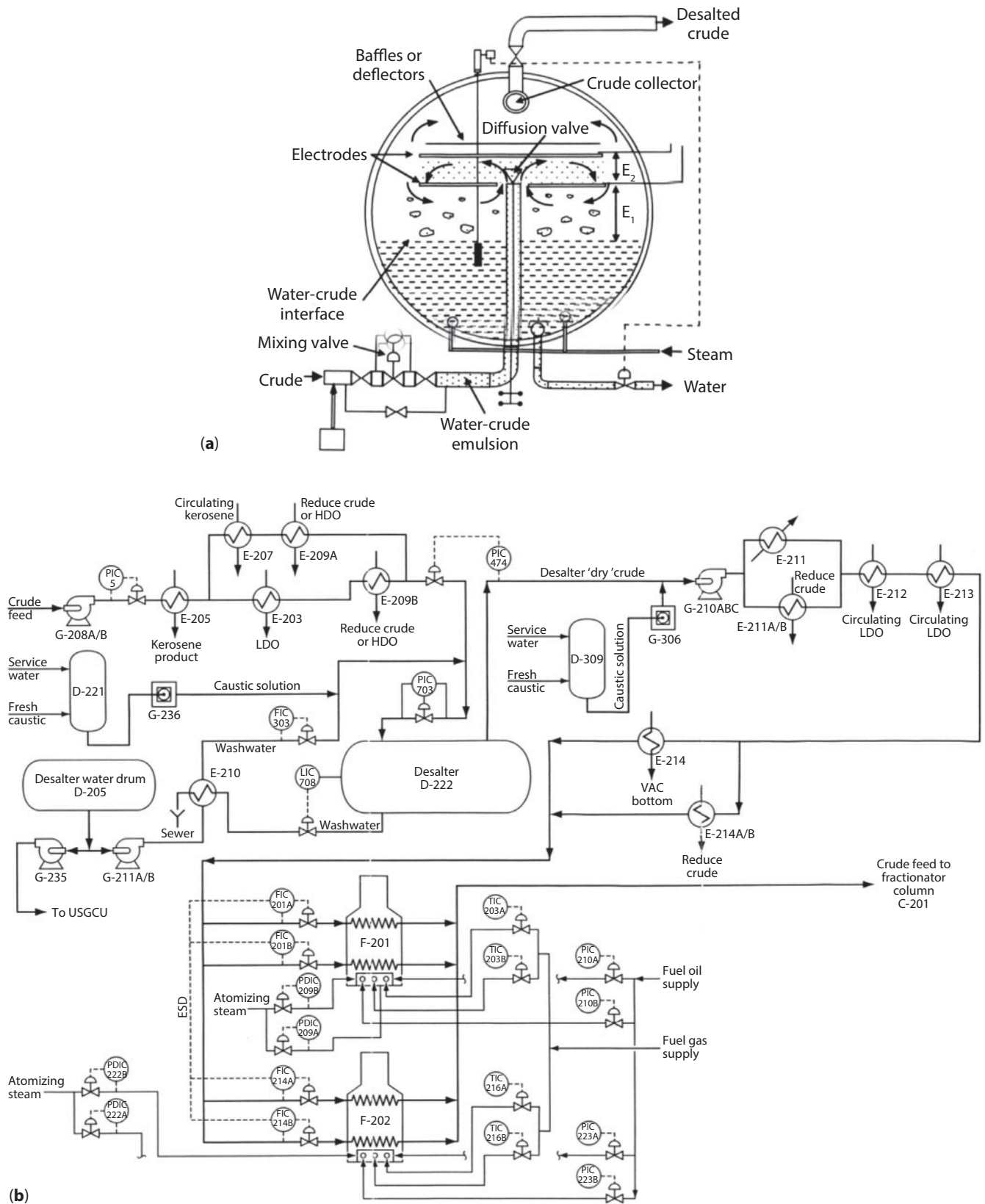


Figure 5.10 (a) An electrostatic desalter (Source: Ptak, *et al.* [4]). (b) Process & Instrument (P & ID) flow diagram of crude charge preheating, desalting and secondary preheating.

Table 5.4 Operating conditions. (Continued)

Parameter	Units	Value
Crude to Desalter*	bpsd	98000
Water to Desalter	gpm	145
Water to crude ratio	%	5
Demulsifier injection	ppmw	10–15
Pressure		
Crude to Desalter	psig	125
ΔP mixing valve	psi	20
Temperature		
Crude to Desalter	°F	270
Water to Desalter	°F	265
Crude from Desalter	°F	260
Analysis Results		
Crude inlet salt	lb/1000 bbl	3.94
Crude inlet salt	ppmw	12.87
Crude outlet salt	ppmw	1.2
Outlet BS & W	% Mass	0.05
Water		
Inlet salt content	ppm	100
Outlet salt content	ppm	310
Inlet oil content	ppm	7
Outlet oil content	ppm	10
pH inlet		6.5
Outlet pH		6.5
Outlet pH after NH ₃		
Injection		7

*30.4 API Crude

Note: Basis 98000 bpsd crude.

(Source: Parkash, S., *Refining Processes Handbook*, Elsevier: Gulf Professional Publishing, Co. 2003).

two metal electrodes. A high-voltage field referred to as the “secondary field” of about 1000V/cm is applied between these two electrodes. Both the ionization of the water droplets and coalescence takes place, and the design achieves ~90% salt removal. Figure 5.10b shows the P & ID of crude oil preheating, desalting and secondary preheating before being charged to a fractionating column. Table 5.4 shows typical operating conditions of the crude in the desalted unit.

Achieving the objectives of successful desalting process requires the following:

Residence Time: The higher the residence time in a desalter, the better the oil/water separation. However,

this variable can be only controlled with the vessel size, operating level in the size or the feed rate. Since the vessel size cannot be increased in size or reduce the feed rate, a small increase in operating level may significantly improve the quality of the brine.

Pressure drop: This variable can be optimized, which is across the desalter mix valve. The higher the pressure drop, the better the mixing and thus the improved removal of salts. However, too high a pressure drop can result in the formation of emulsion layers that are difficult to break. The optimal pressure drop depends on the types of crudes; thus it is important to perform test runs at dedicated periods to ensure that correct operation is achieved.

Polymer injection: Polymers tend to assist in solids separation and emulsion breaking; therefore, correct solution is applied for the system. Polymer types can effectively enhance the separation process for the crudes that are used. Both the injection type and location are important as the longer a chemical interacts with the crude, the better its separation. Polymer injection may be considered for solids separation at the crude tank with another injection for breaking emulsions at the desalter.

Water quality: The quality of water employed for desalting is an essential requirement. Some refinery facilities utilize stripped sour water as a source for the desalter and contaminants in this waste stream may affect its performance. Therefore, monitoring the quality of water is essential so as not to pose problems in the desalter.

The desalter provides a very critical service for the refinery, and thus requires careful monitoring and regular optimization.

After desalting, the crude oil contains from 0.25–0.5 liquid volume percent water from solubility and emulsion effects. The pressure of the desalted crude oil is then raised in a booster pump, and it continues through a preheat train where its temperature is raised by exchange with hot intermediate streams from the crude and vacuum columns. Upon exit from the last preheat exchanger the oil is heated to the desired column inlet temperature in the crude furnace. Furnace outlet temperatures typically range from 630–725 °F (333–385 °C), depending on the crude oil composition.

The hot oil mixture from the furnace then flows through a transfer line into the flash zone of the main fractionation column. Here it mixes with steam and light hydrocarbons from the column stripping zone.

Here, sufficient steam is used to strip the lightest hydrocarbons from the gaseous portion of the oil that rises to the top of the column. The stripping steam also lowers the partial pressure of these hydrocarbons in the column flash zone. This in turn lowers the temperature required to distill the overhead products from the column feed.

The hot liquid from the flash zone drops through the column stripping section, where it is stripped by steam injected into the bottom of the column. The hot vapors from the flash zone rise, contact the colder reflux flowing down the column which condenses out of the side liquid products. Reflux flow is provided by the overhead condenser and by pumparound circuits in which liquid drawn from the side of the condenser is pumped through exchangers and cooled by exchange with crude oil in the preheat train. The cooled pump-around liquid is typically returned to the column a few trays above the draw tray. Pumparound flow rates are high, because heat is being exchanged with crude oil that is at a high flow rate.

The pumparound cooling circuits accomplish three objectives: Firstly, they remove latent heat from the hot flash zone vapors and help condense the side products; secondly, they improve the efficiency of the crude preheat train by allowing heat recovery at higher temperature levels than the overhead condenser alone could achieve. This decreases the duty required from the crude furnace. Finally, they reduce the vapor flow rate through the column thus reducing the required size. Since crude column sizes are primarily determined by the vapor flow rates, the pumparound cooling is an essential factor in their design. However, the pumparound circuits degrade the fractionation between the side products by reducing the internal liquid flows between side products.

The liquid side draw products are usually stripped in steam strippers or recoiled strippers to remove light materials and control their flash points, so the composition of the lightest portion of a liquid side product is controlled by a side stripper, not the main column. In the case of the gas oil side product, stripping is used to remove diesel boiling range materials from the cracking stocks for feeding to fluid catalytic crackers (FCCs).

The reflux arrangements in atmospheric crude distillation unit (CDU) are classified as:

- Top tray reflux.
- Pump back reflux.
- Pumparound reflux.

Top tray reflux: This reflux takes place at the top of the tray, and the reflux is cooled and returned to the tower. In some towers/columns, no reflux is provided to any other plate. Operating the tower only with top reflux has some disadvantages. The heat input to the column is through heated crude at the bottom, and removal is from the top. This creates a large traffic vapor that requires a larger tower diameter. The recovery of heat is less efficient, but the unit is simple in design and operation (Figure 5.11a).

Pump back reflux: In this case, the reflux is provided at regular intervals as this helps every plate to act as a true fractionator. The vapor load on the tower is fairly uniform and requires a smaller column size. The rejected heat at the reflux locations can be effectively utilized. Since the tower temperature increases downwards, the reflux location can be placed where the temperature is sufficient for transferring heat to another stream. Many refineries employ this arrangement as the towers provide excellent service. (Figure 5.11b).

Pump around reflux: In this arrangement, the reflux from a lower plate is taken, cooled and fed into the column at a higher level by 2 to 3 plates. This creates a local problem of mixing uneven compositions of reflux, and liquids present on the tray. This can be overcome by treating all the plates in this zone as a single plate, which results in an increase in the height and the number of plates of the column (Figure 5.11c).

The functions of the pumparound cooling are [5]:

- To remove latent heat from the hot flash zone vapors and help condense the side products.
- To improve the efficiency of the crude preheat train by allowing heat recovery at higher temperature levels than the overhead condenser, thus reducing the required crude furnace duty.
- To reduce the vapor flow rate through the column; this reduces the required size of the column.

The maximum boiling point of the liquid side products is controlled on the main column by their draw rates. For example, to increase the maximum boiling point of the kerosene product as shown in Figure 5.11a, it is necessary to decrease the flow of the diesel product (which has a higher boiling range) and to increase the flow of the kerosene product. This adjustment allows heavier components to travel up the column to the kerosene draw tray, thereby increasing the maximum boiling point of the kerosene product. There may also be a decrease in the lightest portion of the diesel product

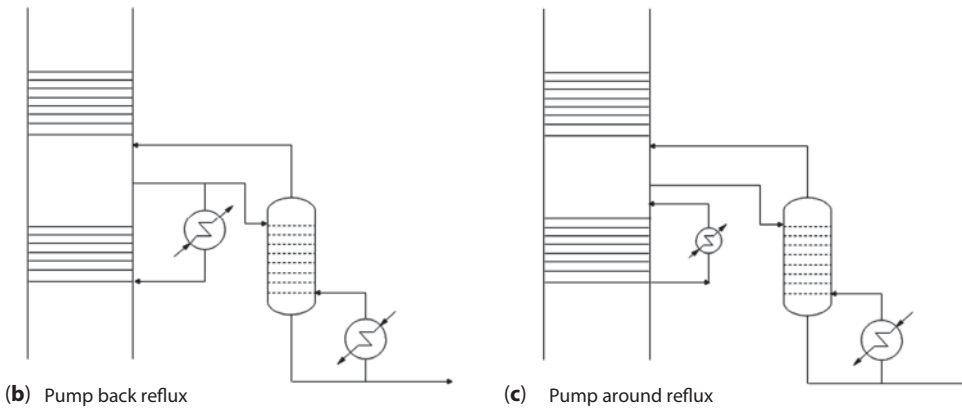
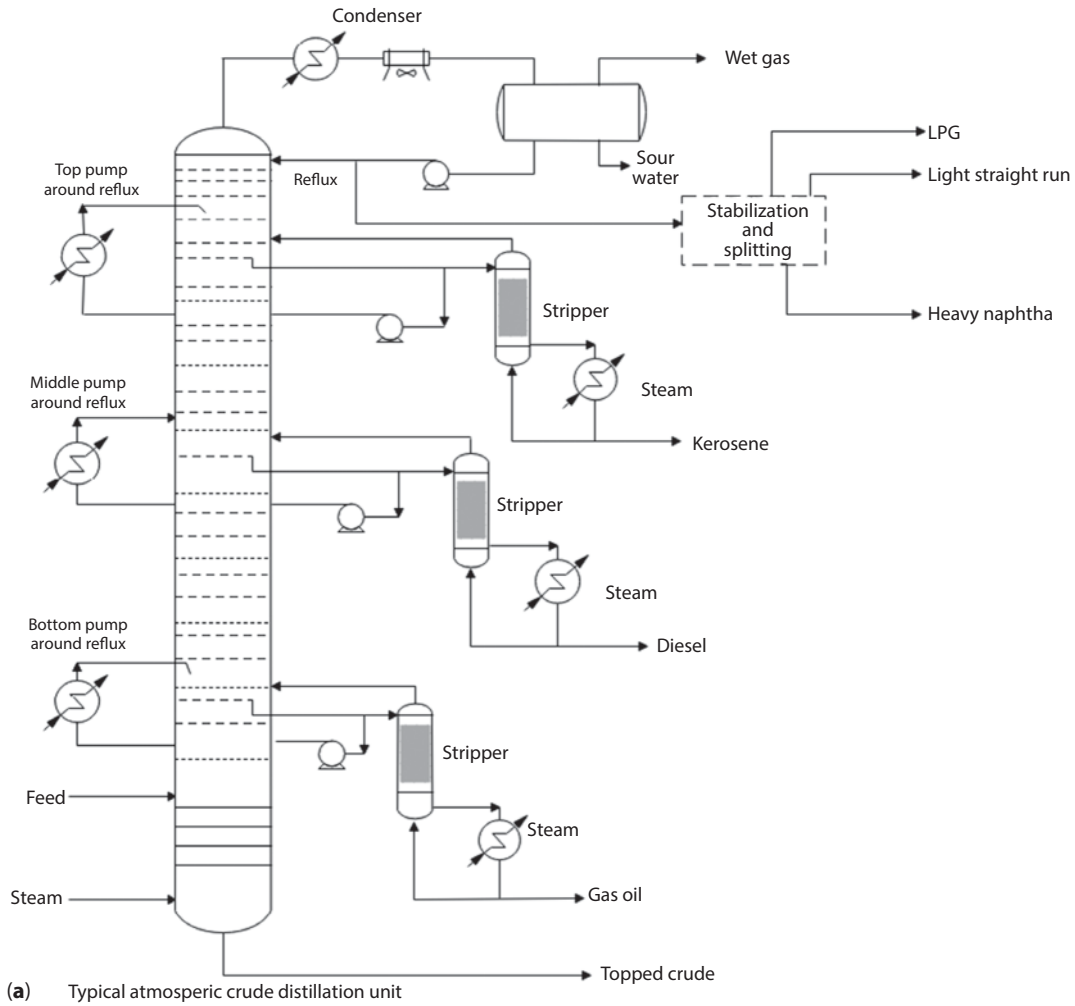


Figure 5.11 (a) Typical atmospheric crude distillation unit. (b) Pump back reflux. (c) Pump around reflux.

because of this adjustment, but this effect is small when compared to the effect of the diesel steam stripper. The number of side draws in a CDU column may be seven to eight; side steam strippers are provided to all crude fractionation units to ensure proper control and products quality to the required specifications.

5.3.4 Pumparound Heat Removal

There are two possible ways of removing the heat from a fractionating/distillation column: top tower reflux (external reflux) and circulating reflux (internal reflux). The circulating/internal reflux stream is referred to as

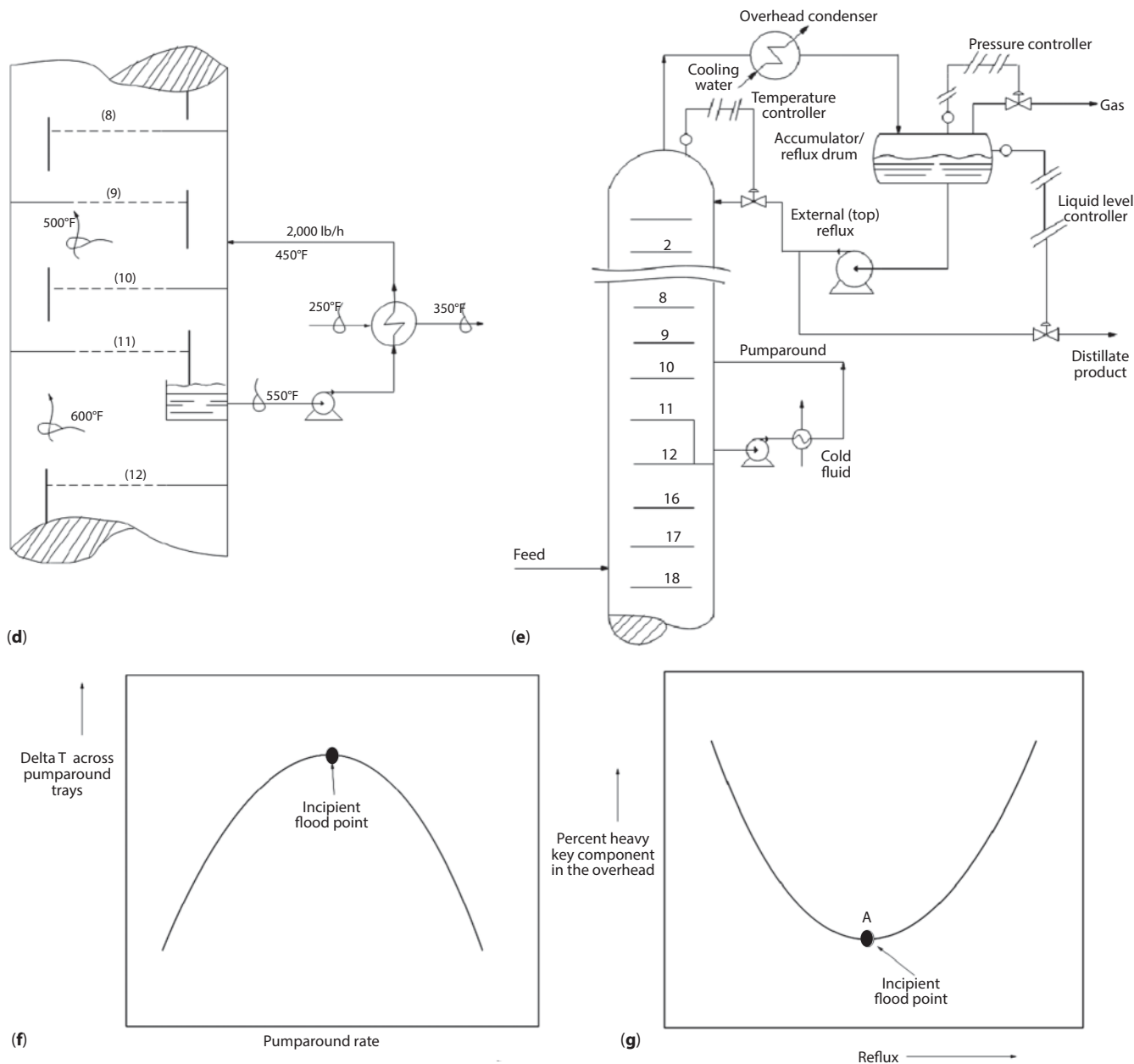


Figure 5.11 (d) A pumparound or circulating internal reflux. (e) Ways of removing heat from a tower. (f) Pumparound trays do fractionate (Source: Lieberman, N. P., and Lieberman, E. T [16]). (g) The incipient flood point (Source: Lieberman, N. P., and Lieberman, E. T [16]).

the pumparound that aids to remove heat from a tower. Figure 5.11d shows a pumparound or internal reflux. The hot liquid at 550 °F is drawn from tray 11, which is referred to as the pumparound draw tray. The liquid pumparound is cooled to 450 °F and returned to the tower at a higher elevation onto tray 10. Figure 5.11d shows that the cold 450 °F pumparound return liquid enters the downcomer from tray 9. Tray 10 is called the pumparound return tray.

The purpose of the pumparound is to cool and partially condense the upflowing vapors. The vapors to

pumparound tray 11 are at 600 °F. The vapors from the pumparound return tray 10 are at 450 °F. There are two pumparound trays (10 and 11) in the column, and the minimum number is used. A typical number of pump-around trays is 2 to 5.

The heat removed in the pumparound circuit in Figure 5.11d is calculated as follows:

The heat balance on the pumparound heat exchanger is:

$$Q = (wc_p \Delta t)_{tube} = (WC_p \Delta T)_{shell}$$

Assuming that the specific heat of the pumparound liquid is 0.65 Btu/lb °F, then the amount of heat removed on the tube side of the heat exchanger is:

$$Q = (w c_p \Delta t)_{tube} \\ = (2000)(0.65)(550 - 450) = 130,000 \text{ Btu/h}$$

If the specific heat of liquid on the shell side (cold side) of the pumparound heat exchanger is 0.55 Btu/lb °F, the amount of flow rate required on the shell side is:

$$W = \frac{Q}{(C_p \Delta T)} = \frac{130,000 \text{ Btu/h}}{[0.55 \text{ Btu}/[(\text{lb})(^\circ\text{F})]](350 - 250)(^\circ\text{F})} \\ = 2,364 \text{ lb/h}$$

Figure 5.11e shows the control valves for the temperature, pressure and level controls and reflux pump for controlling the return level and the distillate product. The top/external reflux flow is controlling the tower-top temperature. If the pumparound circulation rate is reduced, then less heat would be extracted from trays 10 and 11. More and hotter vapor would flow up the tower. The top reflux temperature control valve would open. The top reflux rate would increase. The vaporization of reflux on the top tray would increase, and the overhead condenser duty would increase.

The decrease in the heat duty of the pumparound heat exchanger would equal the increase in the heat duty of the overhead condenser, thus preserving the heat balance of the tower. Some of the heat that was recovered to the cold fluid as shown in Figure 5.11e, is now lost to cooling water in the overhead condenser. This shows the most important function of pumparounds in recovering the heat to a process stream that would otherwise be lost to the cooling tower.

Another purpose of the pumparound is to suppress top-tray flooding. For example, if tray 1 or 2 floods, the following would occur:

- The tower-top temperature increases.
- The distillate product becomes increasingly contaminated with heavier components. In a refinery crude distillation, the endpoint of the naphtha overhead product would increase.
- The pressure drop (ΔP) across the top few trays would increase.
- The liquid level in the reflux drum would increase.

If the reflux rate is increased to reduce the tower-top temperature, the top temperature will increase further rather than decrease. This is an indication of top-tray flooding. This is corrected by increasing the pumparound duty. This can be done by increasing the cold-fluid flow through the pumparound heat exchanger, or the pumparound flow itself could be increased. This subsequently decreases the flow of vapor flowing up to tray 9. The flow of vapor through trays 1 to 8 will also decrease. The low vapor velocity will reduce the tray pressure drop, and the ability of the vapor to entrain liquid will be reduced. The height of liquid in the downcomer will decrease, and tray flooding is suppressed.

Increasing the pumparound heat duty will unload the overhead condenser, which will cool off the reflux drum. A colder reflux drum will absorb more gas into the distillate product. Less gas will be released from the reflux drum, which is often desirable. The heat recovered in the pumparound heat exchanger is often a valuable way to recover process heat. The heat that is not recovered in the pumparound exchanger is lost to cooling water in the overhead condenser. The vapor temperature (Figure 5.11d) leaving tray 10 is 500 °F and the temperature of the liquid leaving tray 11 is 550 °F. This shows that fractionation is taking place across the pumparound trays. The temperature difference between, $\Delta T = (\text{temperature of liquid leaving a lower tray}) - (\text{temperature of vapor leaving a higher tray})$ is a measure of the amount of fractionation. The bigger this temperature difference, the more the fractionation that is taking place across the trays. Lieberman [16] confirmed from plant tests that increasing pumparound circulation rate increases the temperature difference up to a point known as the incipient flood point as shown in Figure 5.11f. If the circulation rate is increased beyond this point, then the temperature difference is reduced. As the pumparound rate is increased, tray efficiency is improved. However, at a certain point, the pumparound liquid flow becomes too great, such that the liquid in the downcomers starts to back up. The tray efficiency is affected because of the downcomer flooding. The temperature difference between the liquid leaving the pumparound draw tray minus the temperature of the vapor leaving the pumparound return tray becomes smaller. This point is referred to as the incipient flood point for the pumparound trays.

Figure 5.11g illustrates point A as an incipient flood point; that point in the tower's operation where either an increase or a decrease in the reflux rate results in a loss of separation efficiency. This point is also referred to as the optimum reflux rate.

5.3.5 Tower Pressure Drop and Flooding

A characteristic of process equipment is such that the best operation is attained at neither a very high nor a very low loading. The intermediate equipment load that results in the most efficient operation is known as the best efficiency point. For distillation trays, the incipient flood point corresponds to the best efficiency point. Correlations have been carried out to determine the best efficiency point for valves and sieve trays and are determined by [16]:

$$\Delta P = K \frac{(NT)(TS)(SpGr)}{28}$$

where

ΔP = pressure drop across a tray section, psi

NT = the number of trays

TS = tray spacing, in.

SpGr = specific gravity of clear liquid at flowing temperatures.

K = 0.18 to 0.25: Tray operation is close to its best efficiency point.

K = 0.35 to 0.40: Tray is suffering from entrainment—increase in reflux rate, noticeably reduces tray efficiency.

K = ≥ 0.5 : Tray is in fully developed flood—opening a vent on the overhead vapor line will blow out liquid with the vapor.

K = 0.10 to 0.12: Tray deck is suffering from low tray efficiency, due to tray deck leaking.

K = 0.00: The liquid level on the tray is zero, and quite likely the trays are lying on the bottom of the column.

5.3.6 Carbon Steel Trays

Flooding is caused by the type of material/alloys used for the trays. Carbon steel trays often enhance flooding when the valve caps are also of carbon steel. The valves tend to stick in a partially closed position, which raises the pressure drop of the vapor flowing through the valves. This pushes up the liquid level in the down-comer draining the tray. The liquid can then back up onto the tray deck and influence jet flood due to entrainment. A reduction in the open area of the tray deck can be caused by dirt, polymers, gums or salts can promote flooding. Most trays flood below their calculated flood point due to these anomalies. Using movable valve caps where deposits can accumulate on the

tray decks will cause the caps to stick to the tray deck. This can be avoided by using grid trays with fixed cap assemblies [16].

5.3.7 Rectifying Section of the Main Column

The zone from the highest side product draw to the column top tray can achieve an overall tray efficiency of 65 to 70% for a reasonable fractionation.

5.3.8 Side Stripping Columns

These columns have six to ten actual trays depending on the design. The reboiler side stripper columns have six to twelve actual trays, as the reboiler is represented as a theoretical tray with a heat source. Three or four theoretical trays are sufficient to represent the side stripping column.

5.3.9 Crude Column Overhead

Figure 5.12 shows a typical crude overhead arrangement. There are at least two condensers in series involving the first exchanging heat with the cold crude oil in the preheat train and the second condenser acting as a trim cooler. The water is circulated back to the condenser inlet to dilute the organic salt compounds in the overhead vapor and reduce corrosion in the condensers.

Figure 5.13 is a photograph of a crude distillation column, crude pre-flash vessel and pre-heater shell and tube heat exchangers in series.

5.3.10 General Properties of Petroleum Fractions

Most petroleum distillates from the atmospheric crude distillation unit (CDU) are defined in terms of their ASTM boiling ranges. The following class of distillates is: liquefied petroleum gas (LPG), naphtha, kerosene, diesel, vacuum gas oil and residual fuel oil.

Distillates

Liquefied Petroleum Gas

The gases from the crude distillation unit are ethane (C_2H_6), propane (C_3H_8) and n-butane (nC_4H_{10}). These products cannot be produced directly from the CDU and thus require high-pressure distillation of overhead gases from the crude column. C_3 and C_4 are recovered

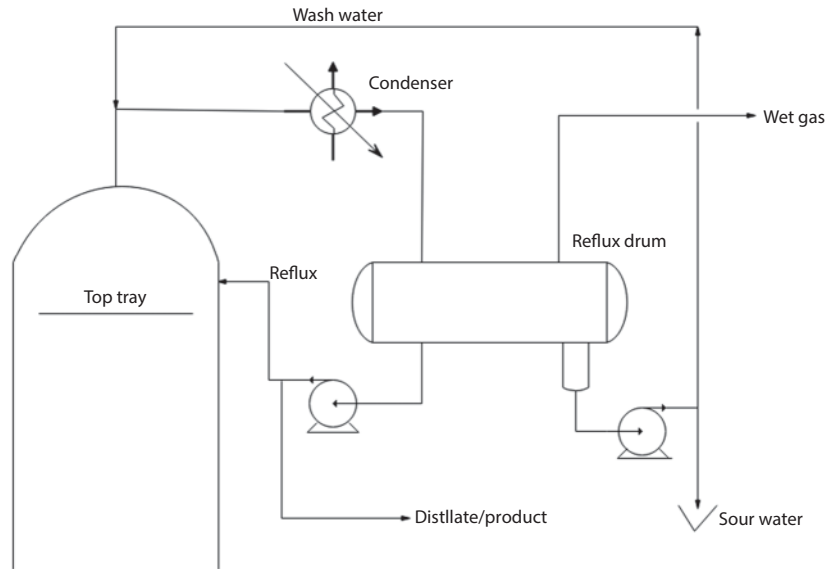


Figure 5.12 Crude column overhead arrangement.



Figure 5.13 A photograph showing the crude distillation column, a pre-flash vessel and pre-heater shell and tube heat exchangers in series.

and sold as liquefied petroleum gas (LPG), while C_1 and C_2 are used as refinery fuel.

Naphtha

This hydrocarbon is C_5 -400 °F (204 °C) ASTM cut. There are many grades and boiling ranges of naphtha, and various refineries produce 400 °F (204 °C) endpoint naphtha as an overhead distillate from the crude column. This is then treated and separated as required in many facilities. Naphtha is used as feedstock for petrochemicals either by thermal cracking to olefins (e.g., ethylene (C_2H_4)) or by reforming and extracting the aromatics (e.g., benzene C_6H_6). Additionally, naphtha

is used in the manufacture of gasoline by a catalytic reforming process.

Kerosene

Kerosene after being treated is used for cooking, illuminating, heating; as an aviation fuel and as turbine fuel. This product has the most stringent specifications, which must be met to ensure the safety standards of the various categories of aircraft. The most important specifications are the flash and freeze points of this fuel. First, the initial boiling point (IBP) is adjusted to meet the minimum flash requirements of approximately 100 °F (38 °C), and the final boiling point (FBP) is adjusted to meet the maximum freeze point requirement of the jet fuel grade ~ -52 °F (-47 °C). Full range kerosene may have an ASTM boiling range between 310–550 °F (154–288 °C). The basic jet fuels are:

1. Jet A-type, a kerosene-type fuel having a maximum freeze point of -40 °C. Jet A-type fuel is used by mainly domestic airlines of many countries, where a higher freeze point imposes no operating limitations.
2. Jet A-1, a kerosene-type fuel as Jet A, but with a maximum freeze point of -47 °C (-53 °F). This fuel type is used by most international airlines. Jet A and Jet A-1 generally have a flash point of 100 °F (38 °C)
3. Jet B is a wide-cut gasoline-type fuel with a maximum freeze point of -58 to -72 °F (-50 to -58 °C). The fuel is of a wider cut, comprising

heavy naphtha and kerosene and is meant for military aircraft.

Some additives are used in aviation turbine fuels; the type and concentration of these additives are closely monitored by appropriate fuel specifications. The following aviation turbine fuel additives are:

- **Antioxidants:** Its use is mandatory in fuels produced by a hydrotreating process to prevent the formation of hydrogen peroxide (H_2O_2), which can cause rapid deterioration of nitrile rubber fuel system components.
- **Fuel system icing inhibitor (FSII):** The main purpose of FSII is to prevent fuel system blockage by ice formation from water precipitated from fuels in flight. Because of the biocidal nature of this additive, it is very effective in reducing microbiological contamination problems in aircraft tanks, and ground fuel handling facilities. However, the use of FSII is only confined to military fuels as the most commercial aircraft are provided with fuel filter heaters and therefore, have no requirement for the anti-icing properties.
- **Static dissipators:** Referred to as anti-static additives or electrical conductivity improvers. Its use is mandatory to increase the electrical conductivity of the fuel, which in turn promotes a rapid relaxation of any static charge build-up during the movement of fuel.
- **Corrosion inhibitor/lubricity improver:** Its use is optional to protect storage tanks and pipelines from corrosion and improve the lubricating properties of the fuel.

Diesel

This hydrocarbon type has an ASTM end point of 650–700 °F (343–371 °C). Diesel fuel is a blend of light and heavy distillates and has an ASTM boiling range of ~ 350–675 °F (343–357 °C). Marine diesel fuels are slightly heavier, having an ASTM boiling end point ~ 775 °F (413 °C). The most important specifications of diesel fuels are cetane number, sulfur, pour or cloud point. Cetane number is related to the burning quality of the fuel in an engine. The permissible sulfur content of diesel is reduced due to the environmental pollution regulations resulting from the combustion of the fuel. Pour point or cloud point of diesel is related to the storage and handling properties of diesel and depends on the climatic conditions in which the fuel is being used.

Gas Oils

The light, atmospheric and vacuum gas oils are processed in a hydrocracker or catalytic cracker to produce gasoline, jet and diesel fuels. The heavier vacuum gas oils can also be used as feedstocks for lubricating oil processing units.

Reduced (Topped) Crude Oil

A residual product that remains after the removal by distillation of an appreciable quantity of the more volatile components of crude oil. The long residue is fed to a vacuum distillation for further processing or sold as residual fuel. The vacuum still bottoms can be processed in a visbreaker, Coker or deasphalting unit to produce heavy fuel oil or cracking or lube-based stocks. For asphalt crudes, the residuum can be processed further to produce road or roofing asphalts.

Table 5.5 shows the products of crude oil distillation, and Table 5.6 shows the approximate boiling ranges for crude oil fractions.

5.4 Process Variables in the Design of Crude Distillation Column

The following are important variables in the design of crude distillation unit:

1. **The nature of the crude:** water content, metal content and heat stability. The latter limits the temperature to which the crude can be heated in the furnace without incipient cracking.
2. **Flash zone operating conditions:** flash zone temperature is limited by advent of cracking; flash zone pressure is set by fixing the reflux drum pressure and adding the value to the line and tower pressure drop.
3. **Over flash:** is the vaporization of crude over and above the crude overhead and side stream products. Over flash is generally kept in the range of 3–6 LV% (LV = Liquid volume). Over flash prevents coking of wash section plates and carryover of coke to the bottom sidestream, and also ensures a better fractionation between the bottom side stream and the tower bottom by providing reflux to plates between the lowest side stream and the flash zone. A larger over flash also consumes more energy, thus over flash is kept to the minimum value for the quality requirement of the bottom side stream.

Table 5.5 Products of crude oil distillation [5].

Fraction	Boiling range	Remarks
1. Gases (mainly methane to the extent of 65–90% together with some ethane, propane and butane)	<68 °F (<20 °C)	Resembles natural gas and is useful for fuel and chemicals. In refineries most of these gases are burned in furnace as fuel due to the costs involved in the recovery.
2. Naphtha a. Light Naphtha (C ₅ -C ₆ hydrocarbons) b. Heavy Naphtha (C ₇ -C ₉ hydrocarbons).	158–284 °F (70–140 °C) 284–392 °F (140–200 °C)	Useful for both fuel and chemicals. But light naphtha is not preferred in gasoline because on catalytic reforming yields the carcinogenic compound benzene. Base for gasoline
3. Atmospheric gas oil a. Kerosene (contains C ₉ -C ₁₆ compounds). b. Diesel fuel (contains C ₁₅ -C ₂₅ compounds, mostly linear)	347–527 °F (175–275 °C) 392–698 °F (200–370 °C)	Used as heating fuel Fuel for Diesel engines
4. Heavy fractions a. Lubricating oil (contains C ₂₅ -C ₄₀ compounds). b. Residual or heavy fuel oil.	>698 °F (> 370 °C) -----	As lubricating oil. Useful as boiler fuel.

(Source: Koch Baby Majoorana, *Modern Petroleum Chemistry: An Overview*, Kannatheri Publications, Kochi, 2003).

Table 5.6 Approximate ASTM boiling point ranges for crude oil fractionation.

Fractions	Boiling range	
	°F	°C
Light naphtha	85–210	30–99
Heavy naphtha	190–400	88–204
Kerosene	340–520	171–271
Atmospheric gas oil	540–820	288–438
Vacuum gas oil	750–1050	399–566
Vacuum residue	1000+	538+

4. **Steam stripping:** the bottom stripping steam is used to recover the light components from the bottom liquid. In the flash zone of an atmospheric distillation column, approximately 50–60% of crude oil input is vaporized. The unvaporized crude travels down the stripping section of the columns, where four to six plates strip out low boiling point distillates still contained in the remaining crude. The steam rate used is approximately 5–10 lbs/bbl of stripped product. The flash point of the stripped stream can be adjusted by varying the steam flow rate.

5. **Fractionation:** is the difference between the 5% ASTM curve of a heavy cut and the 95% point on the ASTM curve of a lighter cut of two adjacent side products. A positive difference is referred to as a gap and a negative difference is referred to as an overlap.

5.4.1 Process Design of a Crude Distillation Column

The following steps in the design of a crude distillation column are:

- Prepare True Boiling Point (TBP) distillation and Equilibrium Flash Vaporization (EFV) curves of the crude to be processed. Several methods are available for converting TBP data to EFV curves.
- Using crude assay data, construct TBP curves for all products except gas and reduced crude. These are then converted to ASTM and EFV curves by Edmister [6], Maxwell [7] or computer methods.
- Prepare material balances of the crude distillation column, on volume and weight basis, showing crude input and product output. In

addition, plot the physical properties, such as the cut range on TBP and LV% and vol% vs. SpGr, molecular weight, mean average boiling point, and enthalpy curves for the crude and its various products.

- Fractionating requirements: Ideal fractionation is the difference between the 5% and 95% points on ASTM distillation curves obtained from ideal TBP curves of adjacent heavier and lighter cuts. Having fixed the gaps as a design parameter, the difference between ideal gap and actual gap required is referred to as the deviation.

The deviation or gap can be correlated with an F factor, which is the product of the number of plates between two adjacent side draws and the internal reflux ratio. The internal reflux is defined as volume of liquid at 60 °F below the draw-off plate of the lighter product, divided by the volume of liquid products at 60 °F, except gas lighter than the adjacent heavier products. This implies that the reflux ratio and the number of plates are interchangeable for a given fractionation.

5.5 Process Simulation

The design of atmospheric column is based upon experience and because of the unpredictable nature of the crudes; special features of design have been developed. The crudes contain innumerable components and thus fall into small close boiling cuts and as such individual separation is not possible. Hence the design is significantly based upon boiling curves as True Boiling Point (TBP) and Equilibrium Flash Vaporization (EFV) curves. Atmospheric towers/columns can be simulated using any of the commercial software as ASPEN PLUS, SimSci, Pro II, HYSYS, UniSim and some of the required guidelines are as follows [9]:

1. Create a unit set using FPS (Foot Pound Second) or MKS (Metric Kilogram Seconds) units along with common refining industry-specific units.
2. Choose a property package, e.g., PENG ROBINSON.
3. Select and add water (H₂O), carbon dioxide (CO₂), hydrogen (H₂), methane (CH₄), ethane (C₂H₆), propane (C₃H₈), iso-butane (i-C₄H₁₀), n-butane (n-C₄H₁₀), iso-pentane (i-C₅H₁₂),

n-pentane (n-C₅H₁₂), hydrogen sulfide (H₂S), and any other components present which can be considered as free components.

A laboratory Crude Assay Data is taken (Table 3.6), which appears as explained below:

The True Boiling Point (TBP) distillation curve will contain liquid volume percentages starting from Initial Boiling Point (IBP) up to about 85 volume percentage with corresponding True Boiling Points. Along with this, light ends analysis will also be given. Another important input is the API gravity of the crude given in degrees API (°API). API (American Petroleum Industry) gravity is expressed by:

$$^{\circ}API = \frac{141.5}{SpGr} - 131.5$$

The above details (TBP, light ends and gravity) are entered in the simulation through appropriate tables.

4. The next step is the creation of pseudo-components or hypo components (both are the same). The process is also called “Cut and Blend”. Usually the crude is cut into about 30 components. But this can be changed as per the user’s discretion. Then a stream called by the name such as “crude oil” or “Feed” is produced in the program. Move onto the simulation environment and check all properties of this stream.
5. Model preflash drum as a **Separator**. Model the crude oil furnace as a **Heater**. Model the crude column as a **Refluxed Absorber** equipped with Pumparounds and Side stream operations. Fix the number of trays for the main column and the strippers. Configure each of the strippers as yielding products as naphtha, kerosene, diesel and gas oils, etc.
6. Install other unit operations; specify the feed and utility conditions.
7. Make a list of products and results you expect from your simulation. Run the simulation and see if you can match your expected results after ensuring item by item that there are no bugs in the data.
8. Check the quality and quantity of products obtained, and change the design parameters as required to obtain the required quality and quantity.

5.5.1 Overall Check of Simulation

It is often a good practice to check the overall design by means of manual methods as it may provide some good suggestions.

The design is based upon three terms: degree of separation, degree of difficulty of separation and ASTM gap.

The degree of separation is encountered in the separation of two close boiling cuts, irrespective of the attainable purity. It otherwise closely resembles relative volatility.

The degree of difficulty of separation is expressed as the difference of ASTM 50% boiling points of two successive cuts. Obviously, a larger difference shows that the separation is easier.

ASTM gap is defined as the difference between 5% boiling point of heavy fractions and 95% boiling point of preceding cut.

When the ASTM gap is not available, TBP overlap may be taken into account. The TBP overlap is the simple difference between FBP (final boiling point) and IBP (Initial boiling point) of successive fractions as illustrated in Figures 5.14 and 5.15, respectively.

The degree of fractionation in a crude unit is determined by the gap or overlap between two adjacent side stream products. For example, the gap or overlap in the boiling point range between kerosene and light gas oil (LGO); in the ideal case, there would be no overlap between these products and the end boiling point of kerosene would be the initial boiling point of the LGO. However, comparing the ASTM distillation boiling points, the ASTM end point of kerosene is higher than the initial ASTM boiling point of LGO, and is referred to as fractionation overlap.

The fractionation gap is defined as the difference between the ASTM 5% boiling point of the products and the 95% point of the lighter product. When this difference is positive, it is referred to as a gap indicating good fractionation. However, a negative difference is called an overlap, an indication that some of the light product is still in the heavier product or vice versa. Figure 5.16 shows the gap and overlap concept and by controlling the cut point of any two consecutive products, the degree of fractionation can be monitored.

Separation capability is denoted by F factor given as:

$F = \text{reflux ratio (or reboil ratio)} \times \text{number of plates in that section}$. This F is related to ASTM 50% difference of fractions (successive) and the gap of these fractions are shown in Figure 5.17.

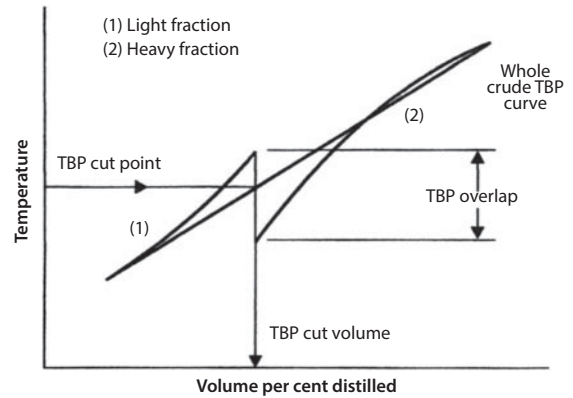


Figure 5.14 True Boiling Point and cut point.

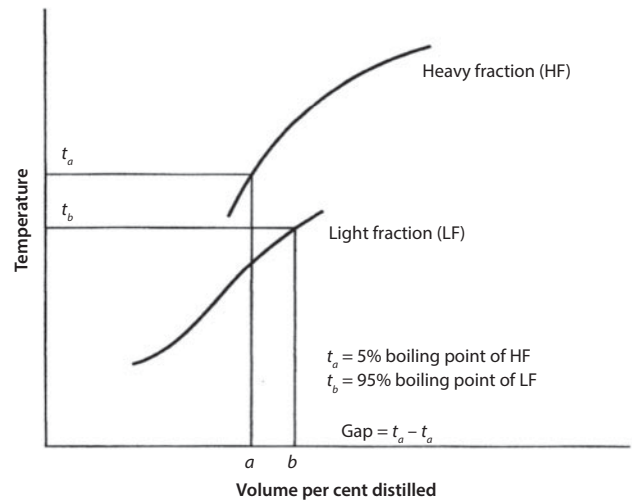


Figure 5.15 ASTM gap.

Example 5.1.

Figure 5.11a shows a middle distillate (diesel) side stream stripper. In a refinery side stream operation, the fraction to be collected is diesel. The diesel entering the side stripper is 4000 bbls/h (barrels per hour), the 50% point of the cut is 275 °C and contaminated with kerosene whose mid-boiling point is 145 °C. If the stripper is having 6 plates, estimate the actual amount of diesel coming out of the stripper if the ASTM gap is 18.6.

Solution

1. Difference of 50% points of the stream is 275–145 = 130 °C.
2. Draw a curve parallel to 125 °C curve for 130 °C in Figure 5.17.

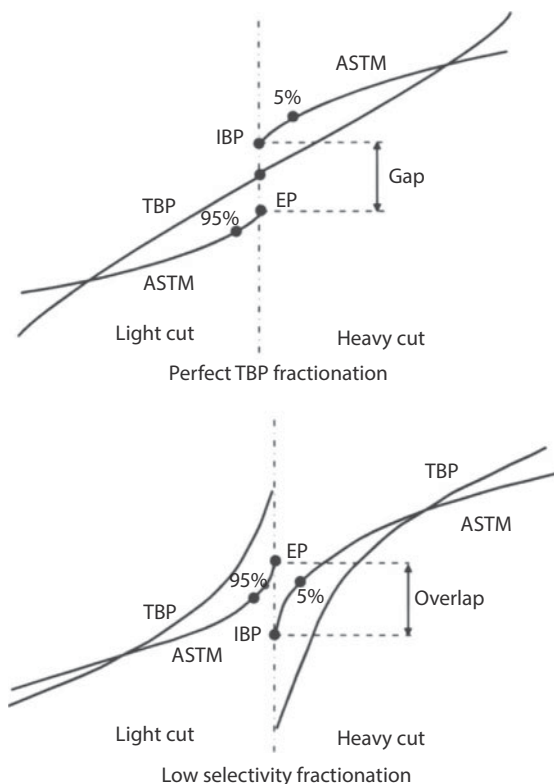


Figure 5.16 Gap and overlap (Source; Ptak *et al.* [3]).

3. Find the F-factor value point on this curve corresponding to an ASTM gap of 18.6. The F-factor value is 4.6.
4. The F-factor is also equal to the reflux ratio multiplied by the number of plates. Dividing F-factor by the number of plates i.e., $4.6/6 = 0.767$, which is the reflux ratio required. Assuming an equimolal counterflow, this can be defined as the ratio of reboiled liquid to input liquid to the stripper column. The fraction that is likely to come out of the stripper is $1/1.767$ of the total feed entering the stripper column.
5. Product draw from stripper for 8 trays = $4,000/1.767 = 2,264$ bbl/hr (barrels per hour). This is an estimate as the correct value can be obtained from the simulation program.

5.5.2 Other Aspects of Design

A large quantity of steam is used during the fractionation process of the crude. The steam is inert that causes a reduction in partial pressure of the hydrocarbons in the tower. A reduction of partial pressure of the hydrocarbons may contribute to an apparent boiling point

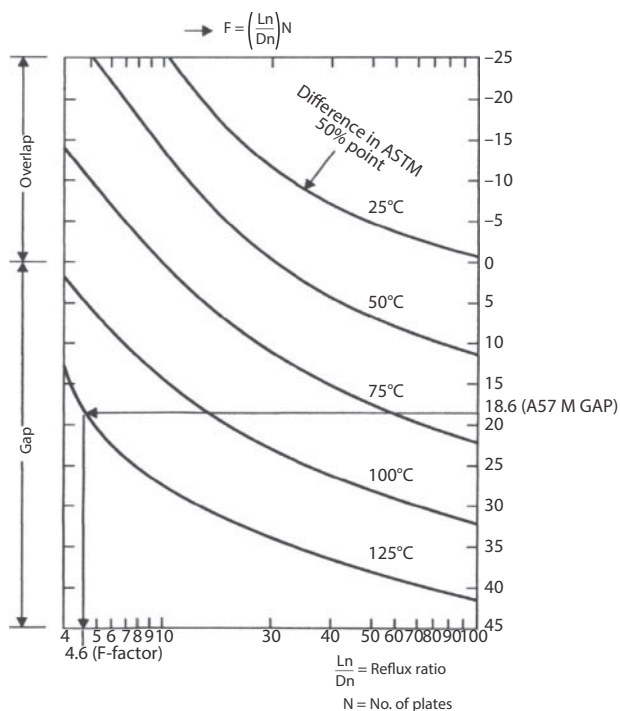


Figure 5.17 F-factor and ASTM gaps [8].

drop of 10–20 °C in distillation columns and side strippers, which saves heating fuel.

The crude is often flashed into the column, and the area where this occurs is referred to as the flash zone as its significance is great due to the following:

- a. An increase in the flash zone pressure increases the draw temperatures.
- b. An increase in an overflash decreases the side draw temperatures from the second onwards. The overflash is that portion of the total vapor leaving the flash zone boiling above the nearest side draw fraction, but never included in that fraction. The overflash allowance is kept to an extent of 2% of the total crude processed in the column. This maintains a good pool of liquid and reflux on the plates. The overflash is mostly from the bottom product of the column.
- c. An increase in steam in the flash zone decreases the product temperature.
- d. The pressure in the flash zone is reflected throughout the column in the form of plate temperatures.
- e. An increase in the flash zone pressure demands more quantity of steam to maintain the designed product.

- f. During fractionation of heavy crudes, a reduction in flash zone pressure enhances a good separation between products, and the yields of products will be as shown by the equilibrium flash vaporization (EFV) curve at the flash zone pressure.

Generally, the ASTM gaps of the crude products are [8]:

Light naphtha to heavy naphtha	12 to 18 °C
Heavy naphtha to light distillate	15 to 30 °C
Light distillate to middle distillate	2 to 6 °C
Middle distillate to first draw	2 to 6 °C

Example 5.2 Boiling Range

Many hydrocarbons in the products and their different boiling points (see Figure 5.11a) have a boiling range. The boiling range is the range in temperature between the initial boiling point and the final boiling point over which a liquid will boil. The initial boiling point is referred to as the overpoint, and the final boiling point is often referred to as the end point. What is the overlap in the fourth sidestream? Table 5.7 shows the product inspections from the atmospheric tower.

Solution:

A range of temperatures is shown for the overhead product and five sidestream products taken from a crude distillation operation. The third sidestream has an initial boiling point (IBP) temperature of 380 °F. When the initial boiling point is 380 °F, it increases as the liquid continues to boil. When the sidestream reaches 470 °F, 50 percent of the liquid stream has boiled off as vapors and it will increase to 90% when the temperature increases to 520 °F. The temperature at which the sidestream boils dry or the final boiling point (FBP) is 560 °F. The fourth sidestream is heavier than the third sidestream and has an initial boiling

point (IBP) of 500 °F. The difference between the FBP of the third sidestream and the IBP of the heavier fourth sidestream is 60 °F. This is referred to as the overlap. While fractionation improves as the overlap decreases, it is impractical to attain a zero overlap because of the operational changes that would be required. In fractionation, it is essential to maintain specific product quality by controlling such process variables as temperature, pressure, flow rate and level.

5.5.3 Relationship between Actual Trays and Theoretical Trays

All rigorous column calculation methods are based on theoretical trays where the vapor and liquid leaving the tray are in perfect vapor-liquid equilibrium. However, real operating columns are equipped with actual trays, not theoretical trays. Therefore, the actual trays in a real column must be represented by theoretical trays in the model. The performance of an actual tray compared to the performance of the corresponding theoretical tray is referred to as the tray efficiency. There are mathematical expressions derived to represent tray efficiency. However, the most useful concept in distillation problems is the overall efficiency. The overall efficiency usually refers to the entire column and is defined by:

$$\eta_{\text{overall efficiency}} = \frac{\text{No. theoretical trays}}{\text{No. actual trays}} \quad (5.8)$$

Overall efficiencies may be defined for the entire columns or zones or within columns and therefore, enable a direct translation of the column actual trays into theoretical trays. Fractional trays are not considered in this efficiency model, and the efficiencies are expressed on a percentage basis. The overall efficiencies for nearly all columns are less than 100%, and the column has fewer theoretical trays than actual trays. With this definition of efficiency, all trays in the column model act as perfect vapor-liquid equilibrium stages for the distillations. There are few open literature correlations for predicting overall efficiencies.

Table 5.7 Product inspections from atmospheric tower.

	Tower overhead	1 st Side stream	2 nd Side stream	3 rd Side stream	4 th Side stream	5 th Side stream
IBP (°F)	75	245	305	380	500	575
50% off @	185	300	370	470	580	645
90% off @	230	315	385	520	605	670
FBP (°F)	280	350	420	560	670	730

However, one such correlation based on data for 54 refinery columns is illustrated in Figure 5.18 [10].

The efficiency is for the key components and the viscosity is the average of the feed as liquid at the top and bottom temperatures for the column. For absorbers, the rich oil exit temperature is used. However, this correlation has been modified by O'Connell (Figure 5.19) to improve the predictions for columns with high relative volatilities such as absorbers. For this method, the relative volatility of the key components and feed liquid viscosity are determined at column average conditions. O'Connell based his work on commercial and laboratory column data; thus these two correlations are probably the most useful ones for overall tray efficiency.

Table 5.8 presents some typical overall efficiency for various columns used in petroleum refineries.

5.6 Process Description of Light Arabian Crude Using UniSim[®] Simulation Software [12]

A Case Study

Honeywell UniSim[®] simulation software was used to simulate the crude oil from the pre-flash unit to the crude distillation fractionators. The following illustrates the description of the process.

After characterization (Figure 5.20), the crude oil passes through a preheat train, 10,000 barrel/day at 29°API and fed into a pre-flash separator operating at 450 °F (232 °C) and 75 psia. The vapor from this separator bypasses the crude furnace and is remixed

with the hot at 650 °F (343 °C) pre-flash liquids leaving the furnace. The combined stream is then fed to atmospheric crude column as shown in Figure 5.21. The column operates with a total condenser, three coupled side strippers and three pumparound circuits. Light gases and a naphtha product are produced overhead; a kerosene product is the product from the first recoiled side stripper, and a diesel product is produced from the second steam-stripped side stripper, and an atmospheric gas oil (AGO) is produced from the third steam-stripped side stripper. This is further processed in the vacuum distillation unit. Figure 5.22 shows a snapshot of the process flow diagram of the crude distillation unit with pumparounds and side strippers, and Table 5.9 shows typical operating conditions of atmospheric distillation column.

The two basic steps in the process simulation are:

1. Setup involves listing the components between $C_1 - C_4$ light ends, as well as the pseudo-components that will be used to represent the C_5^+ portion of the crude oil. The oil characterization procedure as described earlier is used to convert the laboratory data into petroleum pseudo-components.
2. Steady-state simulation modeling involves simulating the pre-fractionation train consisting of a separator and heater. This determines the feed to the atmospheric fractionators, and includes the pre-flash separator, crude furnace and mixer which recombine the pre-flash vapor and furnace outlet streams.

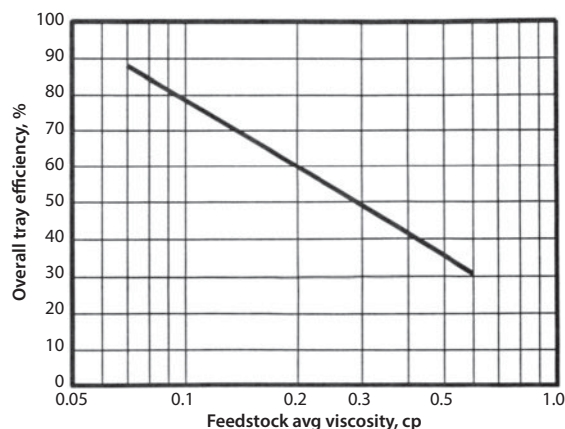


Figure 5.18 Overall tray efficiencies: Refinery columns correlation of Drickamer and Bradford [10].

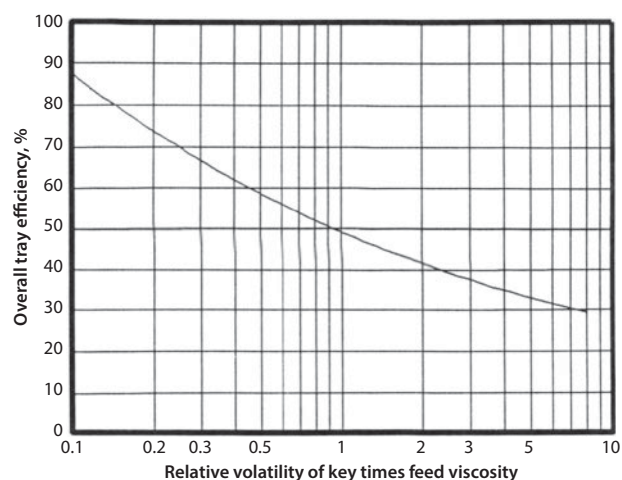


Figure 5.19 Overall tray efficiencies—Correlation of O'Connell [11].

Table 5.8 Overall tray efficiency [4].

Column service	Typical no. of actual trays	Typical overall efficiency	Typical no. of theoretical trays
Simple Absorb/Strip	20–30	20–30	
Steam Side Stripper	5–7		2
Reboil Side Stripper	7–10		3–4
Reboiled Absorber	20–40	40–50	
Deethanizer	25–35	65–70	
Depropanizer	35–40	70–80	
Debutanizer	38–45	85–90	
Alky DeiC ₄ (reflux)	75–90	85–90	
Alky DeiC ₄ (no reflux)	55–70	55–65	
Naphtha Splitter	25–35	70–75	
C ₂ Splitter	110–130	95–100	
C ₃ Splitter	200–250	95–100	
C ₄ Splitter	70–80	85–90	
Amine Contactor	20–24		4–5
Amine Stripper	20–24	45–55	9–12
Crude Distillation	35–50	50–60	20–30
Stripping zone	5–7	30	2
Flash zone–1 st draw	3–7	30	1–2
1 st Draw–2 nd Draw	7–10	45–50	3–5
2 nd Draw–3 rd Draw	7–10	50–55	3–5
Top Draw to Reflux	10–12	60–70	6–8
Vacuum Column (G.O. Operation)			
Stripping	2–4		1
Fl. Zone to HGO Draw	2–3		1–2
HGO section	3–5		2
LGO section	3–5		2
FCC Main Fract.	24–35	50–60	13–17
Quench zone	5–7		2
Quench–HGO Draw	3–5		2–3
HGO - LCGO	6–8		3–5
LCGO - Top	7–10		5–7

The atmospheric crude fractionator: involves adding the column streams inlets to the flow sheet and installing the crude fractionator using the rigorous distillation column operation.

Before simulating the atmospheric crude tower, the steam feeds as well as the energy stream to the column must be defined. Three streams are fed to various locations in the column. The main column, atmospheric

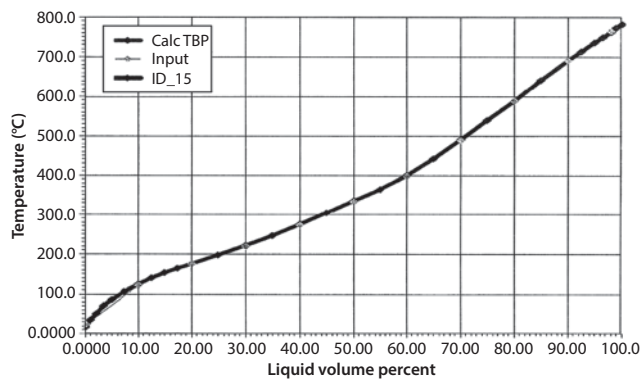


Figure 5.20 True boiling point distillation–Arab Extra Light 36.7.

tower is represented by 29 ideal stages (not including the condenser). The pressures of the overhead condenser, top stage and the bottom are 19.7 psia; 28.7 psia and 32.7 psia, respectively. The condenser experiences a $\Delta P = 9$ psi. The temperature estimates for the condenser, top stage, and the bottom stage are 100 °F (37.8 °C); 250 °F (121 °C) and 600 °F (316 °C) respectively. The condenser water is removed via a side water draw from the three-phase condenser.

Solution of fractionation calculations involves a trial-and-error procedure. Temperature and flow profiles are assumed for all trays in the column and

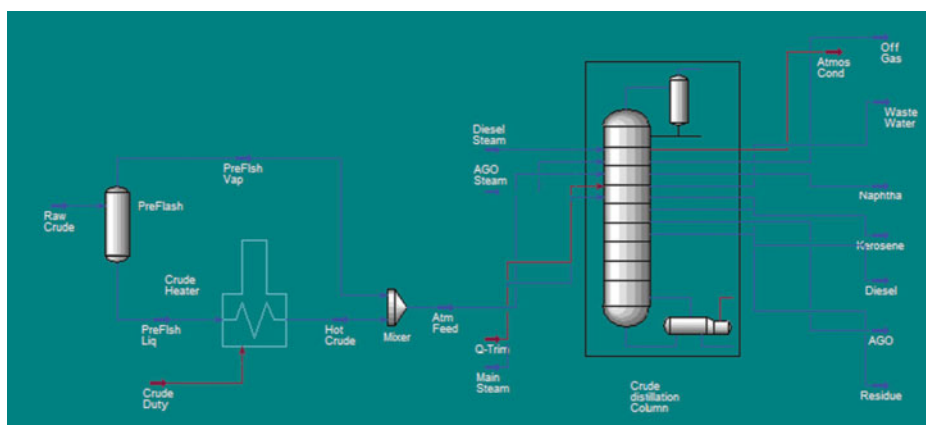


Figure 5.21 Snapshot of process flow diagram of the crude distillation unit (Courtesy of UniSim Design R443, Honeywell Process Honeywell (R) and UniSim (R) are registered trademarks of Honeywell International Inc.).

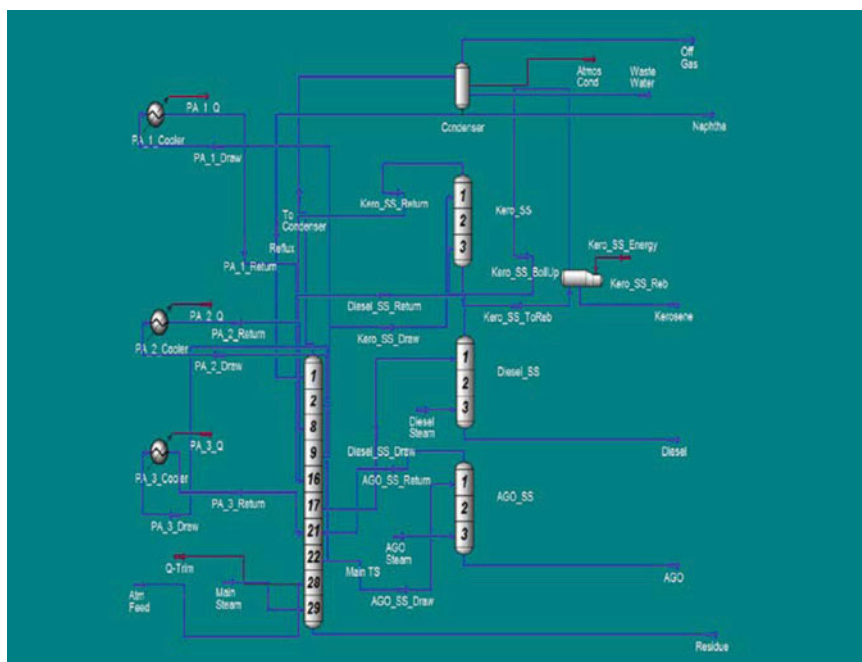


Figure 5.22 A snapshot of crude distillation unit with pumpharound and side strippers (Courtesy of UniSim Design R443, Honeywell Process Solutions, Honeywell(R) and UniSim(R) are registered trademarks of Honeywell International Inc.).

Table 5.9 Atmospheric crude distillation column operating conditions.

Operating parameter	Units	Value
Temperature	°F	
Transfer line		660
Flash zone		657
Tower top		359
Kerosene draw-off		469
Pumparaound draw-off		548
Pumparaound return		345
Light diesel draw-off		603
Tower bottom		648
Pressure	psig	
Reflux drum		2.0
Tower top		10.3
Flash zone		14.7
Reflux ratio, reflux/Liq.dist.		0.6
Stripping Steam		
To Atmospheric tower	lbs/bbl Resid.	5.5
To Kerosene stripper	lbs/bbl Resid	5.9
To Diesel stripper	lbs/bbl Resid	2.1
Atmospheric Heater		
Process fluid conditions		
Temperature In	°F	453
Temperature Out	°F	660
Pressure drop	psi	138
Tube skin temperature (Avg.)	°F	735
Stack gas temperature	°F	725
Fractionation Efficiency		
5%-95% ASTM distribution gap		
Atmospheric Naphtha-Kerosene		Gap + 10
Kerosene-Light diesel		Gap-36

Note: Basis 154000 bpsd Kuwait Crude Run.

vapor-liquid equilibrium, and heat balances are calculated using the rigorous method for each tray. All calculation procedures keep the column pressures constant. The results from the assumed profiles are used for subsequent series of calculations. Computations are further complicated by the fact that the equilibrium K values for the components on each tray are affected by the tray composition as well as the temperature and

pressure. Further, all of the tray-to-tray calculations are coupled into a large set of equations, which describe the component mass balances and the heat balances for every tray, the vapor-liquid equilibrium relationships between the trays and the overall heat and mass balances for the entire operation. Equations are added to define process conditions or specifications that must be met by the solution. All the above conditions must satisfy the solution for steady-state operation for a converged solution. A converged solution is defined as a set of independent variables for the column, e.g., flows, heat inputs, tray temperatures, etc., which produce a solution for all the column equations within certain specified tolerances. Tolerances are prescribed for the component material balances; the tray heat balances, the tray equilibrium relationships (e.g., expressed as the tray liquid bubble point condition), the performance specifications and the tray equilibrium K values. The latter tolerance is required since the K values are dependent on composition. Therefore, it is essential that the K-values converge together with all the column equations. Several methods have been described in the literature to solve rigorous distillation problems and one of the most useful methods for a solution of petroleum distillation columns is the *inside-out* method, which is described elsewhere [13].

5.6.1 Column Conventions

The column conventions are similar for all process simulators. All distillation calculation methods are derived for theoretical trays, i.e., trays in which perfect vapor-liquid equilibrium is achieved between the existing liquid and vapor. The condenser and overhead accumulator drum are considered to be the first tray. A net liquid product from this tray is returned to the column as reflux. Liquid and vapor products are withdrawn from the reflux drum. For columns where only a liquid product is withdrawn from the reflux drum and the condenser, it is not truly a theoretical tray. For many columns, the liquid product is sub-cooled below its bubble point. The same convention is followed, and the overhead system is still referred to as the first tray. The top tray of the column is considered to be the second tray for a column with a condenser. The last tray at the bottom is referred to as the N^{th} - tray.

The reboiler is normally considered to be the highest tray number, $N + 1$. Columns may have side liquid, and vapor draws and side water draws. Side stripping columns (e.g., for kerosene, light and heavy gas oils, diesel, etc.) may also be attached to the column. Side

columns are solved simultaneously with the main column by the inside-out method. Pumparounds side draws are used to remove heat from the column, and columns may have multiple feeds. UniSim designates the condenser-reflux drum trays as the *condenser* and the second tray as tray number one. It also designates the *reboiler* (when present) as the reboiler and tray N as the highest tray number in the column model. For columns with no condenser-reflux drum, e.g., a recoiled stripper, the top tray of the column is designated as tray one by all simulators. For columns with no reboiler e.g., an absorber, the bottom tray of the column is designated as tray N by all simulators.

5.6.2 Performance Specifications Definition

Poorly chosen specifications are the cause of nearly all convergence failures when solving distillation problems using the inside-out method. Therefore, it is important that correct column performance specifications be chosen. Additionally, specifications for the column model should be similar to those used to control the actual operation. Thus the need for actual column operation is important for the user. For every specification imposed on a column model, there must be a corresponding degree of freedom or parameter that is not specified. The degree of freedom enables the user to seek the level required to satisfy the performance specification equation in the solution, as the degree of freedom affects the performance specification. For distillation models, the choices of the degrees of freedom are the column heat sinks; the side product draw rates, and the column heat sources. For example, a conventional column with two products, a reboiler and a condenser has two possible degrees of freedom and may thus have two performance specifications.

5.6.3 Cut Points

The cut points in the crude distillation unit (CDU) are controlled by the overhead vapor temperature that determines how much vapor enters the condensers to produce light naphtha and by the flow rate of the various products straight from the column or the side stream strippers. Additionally, the atmospheric residue level control inside the column determines its flow rate and thus its initial cut point.

The amount of light naphtha is determined by the dew point at its partial pressure, which is close to the overhead temperature. Changing the draw-off rate of any product affects the cut points of the heavier

product below it. For example, lowering the kerosene flow rate will lower its end point (i.e., make it lighter), but will also modify the initial cut point of the light gas oil (LGO) and heavy gas oil (HGO) and the initial cut point of the atmospheric residue. The residue flow rate, the initial reflux rate, the draw-off temperatures and the pumparounds will be affected [14].

Therefore, if the cut point of the one stream is changed through a change in its withdrawal rate, the flow rate of the heavier product next to it should be changed in the reverse and by the same amount in order to make the changes in the desired stream. For example, reducing the end point of kerosene by decreasing its flow rate by a certain amount would invariably require an increase in LGO by the same amount. If this action is taken, only the cut point of kerosene is affected as the cut points of the other products remain unchanged.

The side stream rate also affects the temperature of the withdrawal tray and lowers the internal reflux exiting the tray. The internal reflux rate affects the degree of separation. It can be increased by increasing the heater outer temperature and by reducing the pump-around duty in the lower section of the column. When less heat is removed by the lower pumparound, more vapors will be available up the column and more internal reflux is produced as the vapors are condensed.

5.6.4 Degree of Separation

The separation quality between two consecutive streams is affected by several factors: vapors and liquid flow rates in the column zone between two streams, the number of trays and the heat removed by the pump-around. Fractionation quality is determined in terms of gap or overlap of the products. For perfect separation, zero gap and overlap are required. This means that the end boiling point (EBP) of the light cut would be the initial boiling point (IBP) of the heavier cut, etc. [14].

5.6.5 Overflash

In order to separate the crude oil into the various products, it has to be heated to a temperature between 626–725 °F (330–385 °C), depending on the crude composition. The partially vaporized crude is transferred to the flash zone of the column located at a point lower down the column. The furnace outlet temperature should be high enough to vaporize all the products that are withdrawn above the flash zone plus about 3–5 vol% of the bottom products. This overflash has the function of providing liquid wash to the vapors rising up

the column from the flash zone, and thereby enhancing separation on the trays above the flash zone. This improves the quality of the heavy gas oil (HGO) and reduces the overlap with the bottom products below the flash zone. This ensures that few trays in the region between the flash zone, and the HGO draw-off are required. The overflow provides heat input to the column in excess to that needed to fractionate the overhead products. It also prevents coke deposition on the trays in the wash zone.

The furnace outlet temperature is controlled to maintain coking inside the furnace tubes in the column flash zone to a minimum; the composition of the crude could determine the maximum temperature that is allowed. Paraffinic crude oils crack more readily than asphaltic or aromatic crude. Therefore, the furnace outlet temperature for paraffinic crude oils is lower than that for other crude types.

5.6.6 Column Pressure

The pressure of the CDU is controlled by the back pressure of the overhead reflux drum at about 3–5 psig (0.2–0.34 barg). Although some refineries operate at pressures as high as 30 psig (2.1 barg). A higher pressure reduces vapor loading, but increases the flash zone temperature. The top tray pressure of the main column is 6 to 10 psi (0.4 to 0.7 bar) higher than the reflux drum, depending on the drop through the overhead vapor line and coolers. The flash zone pressure is normally in the range of 5 to 8 psi (0.34 to 0.55 bar) higher than the top tray, with the furnace transfer line pressure of 5 psi (0.34 bar) higher than the flash zone.

5.6.7 Overhead Temperature

The overhead temperature must be controlled in the range 25–30 °F (13.9–16.7 °C) higher than the dew point temperature for the water at the column overhead pressure so that no liquid water is condensed in the column. This is to prevent corrosion due to the hydrogen chloride dissolved in liquid water to form hydrochloric acid (HCl). The dew point of the water using the steam tables is illustrated as follows [4]:

A heavy crude oil requires a higher overhead temperature than a light crude oil. A heavy crude oil requires more bottom stripping steam and produces a fewer overhead hydrocarbon product. Therefore, the mole fraction of the water in the column overhead vapor increases. This raises the water partial pressure

in the overhead vapor, which raises the saturation temperature of the water. It is necessary to increase the column overhead temperature versus the light crude to suppress condensation of water in the top of the column.

Data: Water mole fraction in overhead vapor: 0.085

Main column overhead pressure = 34.7 psia (2.39 bar)

The partial pressure: $p_{H_2O} = y_{H_2O} P_{col}$

The water partial pressure = $0.085 \times 34.7 = 2.95$ psia (0.2 bar)

From the Steam Tables:

Water saturation temperature at 2.95 psia = 141 °F (60.9 °C)

Therefore, the safe overhead operating temperature = $141 + 30 = 171$ °F (77.6 °C)

The following gives a trial and error procedure used to determine the temperature [17]:

1. The temperature of reflux drum is fixed, keeping in view the maximum temperature of the cooling medium (water or air).
2. Estimate the tower overhead temperature, assuming steam does not condense at that temperature.
3. Run a heat balance around top of the tower to determine the heat to be removed by pump-back reflux. Calculate the quantity of pump-back reflux.
4. Calculate the partial pressure of the distillate and reflux in the overhead vapor. Adjust the 100% point temperature on the distillate atmospheric flash vaporization curve to the partial pressure.
5. Repeat these steps until the calculated temperature is equal to the one estimated.
6. Calculate the partial pressure of steam in the overhead vapor. If the vapor pressure of steam at the overhead temperature is greater than the partial pressure of steam, then the assumption that steam does not condense is correct. If not, it is necessary to assume a quantity of steam condensing and repeat all steps until the partial pressure of steam in the overhead vapor is equal to the vapor pressure of water at the overhead temperature. Also, it is necessary to provide sidestream water draw-off facilities.
7. To calculate the overhead gas and distillate quantities, make a component analysis of total tower overhead stream consisting of overhead

gas, overhead distillate, pumpback reflux, and steam. Next, make a flash calculation on the total overhead vapor at the distillate drum pressure and temperature.

8. The overhead condenser duty is determined by making an enthalpy balance around the top of the tower.

5.6.8 Bottom Stripping

The amount of liquid to be vaporized by the stripping steam at the bottom of the fractionating column is determined by constructing the flash curve of this liquid (referred to as the initial bottoms). The flash curve of the reduced crude is constructed from the flash curve of the whole crude. It is assumed that the initial bottom is flashed in the presence of the stripping steam at the pressure existing on the top of the stripping plate and at the exit temperature of liquid from this plate [7].

About 50–60% of the crude is vaporized in the flash zone of the atmospheric tower. The unvaporized crude travels down the stripping section of the tower consisting of four to six plates, and is stripped of any remaining low-boiling hydrocarbons by superheated steam at 600 °F (316 °C). The steam rate is 5–10 bl/bbl of stripped product. The flash point is adjusted by varying the stripping rate.

5.6.9 Side Stream Stripper

Distillate products such as kerosene and diesel are withdrawn from the column as side stream and usually contain materials from adjacent cuts as naphtha and light diesel. Therefore, kerosene cut may contain some naphtha, and the light diesel cut may include some kerosene-range boiling material. These side cuts are steam stripped using superheated steam, in small side-stream stripper columns of about four to six plates. In this column, lower-boiling hydrocarbons are stripped out; the flash point of the product is then adjusted to the required specifications.

5.6.10 Reflux

In normal distillation columns, heat is supplied to the column from a reboiler and removed in an overhead condenser via cooling. The reflux is provided at the top of the column by pumping some of the condensed liquid back to the top tray. The reflux is also provided at intermediate locations in the column with

pumparound cooling circuits. The hot liquid portion of the crude oil feed is stripped with steam to remove dissolved light hydrocarbons before leaving the bottom of the column. To recover the maximum heat and ensuring a uniform vapor and liquid loads, intermediate refluxes are used, which withdraw liquid as side streams and exchange heat with the incoming crude oil before entering the furnace and are returned to the plate above in the column.

Nelson [18] presents four fundamental principles for the operation of crude columns:

1. The yield of a given product is primarily a function of the composition of the feed mixture and not the degree of separation.
2. The number of trays only slightly alters the boiling range of the products as defined by ASTM initial boiling points and end points.
3. The initial boiling point of side draw products is always low, and it must be corrected by either steam stripping or reprocessing.
4. The end point of a side draw product is primarily controlled by opening or closing the draw valve to change the yield.

5.7 Troubleshooting Actual Columns

Troubleshooting with computer simulation must be dependent on mathematically converged column solutions, as it is impossible to attain valid conclusions using simulation models for which the column, mathematical constraints are unsatisfied. Thus the first stage in troubleshooting is to ensure converged results with the column model. The column models must be ascertained as being in predictive mode for troubleshooting. The models based on local tray efficiency models will yield poor results because they cannot predict an alternate operating point. Computer simulation has successfully been applied to petroleum distillation problems; however, the necessity of representing petroleum mixtures with pseudo-components has been a serious impediment to the development of accurate models. Therefore, where a computer model matches the actual operation, there are definitive reasons. Differences between the model and the plant are commonly reflected in the product properties, product compositions, product rates, column temperatures, top reflux rates, internal liquid flow rates and heat duties. Kaes [4] has described various step-wise approaches when matching models to plant data.

Figures 5.23 and 5.24 show the temperature and pressure profiles versus tray position respectively from the top. The zones of relatively constant temperature in the column indicate tray damage or missing trays. It is not an uncommon occurrence where tray man ways have been left open during construction or turnarounds.

Simulation program of the crude using UniSim[®] software (**crude-oil-distillation.usc**) can be accessed from **Scrivener** website, which contains the results of the simulation Table 5.10 shows rules for the design and operation of petroleum fractionators.

The design of refinery fractionation columns can be complex. The pumparound streams function as intermediate condensers and remove surplus heat from the column. This heat is usually recovered by heat exchange with the cold crude oil feed. Oil refineries are often designed to handle various crude types with boiling assays. The refinery requires responding to market conditions by making different product slates at different times of the year. The crude oil fractionation and associated equipment (e.g., heat exchanger networks) must be flexible enough to handle the changes, while still attaining very tight specifications on the boiling point curves of every product. Table 5.11

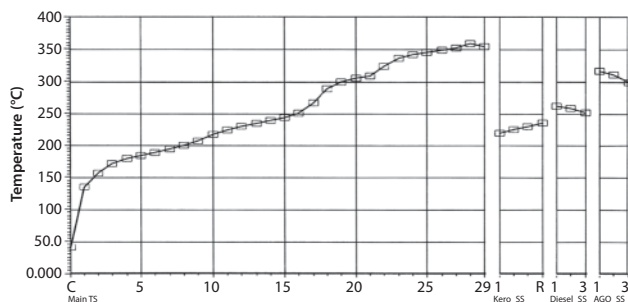


Figure 5.23 Temperature vs. tray position from top.

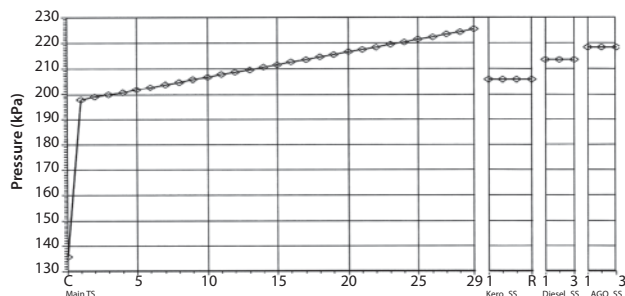


Figure 5.24 Pressure vs. tray position from top.

shows a troubleshooting checklist of a crude unit, and Table 5.12 shows typical CDU products, their end boiling points and their disposition.

5.8 Health, Safety and Environment Considerations

Fire Prevention and Protection: Heaters and exchangers are closed processes in the atmospheric and vacuum distillation units could provide a source of ignition, and the potential for a fire exists should a leak or release occur.

Safety: An increase in pressure, temperature or liquid levels may occur if automatic control devices fail. Control of temperature, pressure and reflux within operating parameters is required to prevent thermal cracking within the distillation towers. Relief systems should be provided for overpressure and operations monitored to prevent crude from entering the reformer charge. This is reviewed in detail further in the text.

The sections of the process susceptible to corrosion include preheat exchanger (hydrochloric acid, HCl, hydrogen sulfide, H₂S), preheat furnace and bottoms exchanger (H₂S and sulfur compounds), atmospheric tower and vacuum furnace (H₂S, sulfur compounds, and organic acids), vacuum tower (H₂S and organic acids), overhead (H₂S, HCl and water). Where sour crudes are processed, severe corrosion can occur in furnace tubing and in both atmospheric and vacuum towers where metal temperatures exceed 450 °F (232 °C). Wet H₂S also will cause cracks in steel. When processing high-nitrogen crudes, nitrogen oxides can form in the flue gases of furnaces. Nitrogen oxides are corrosive to steel when cooled to low temperatures in the presence of water.

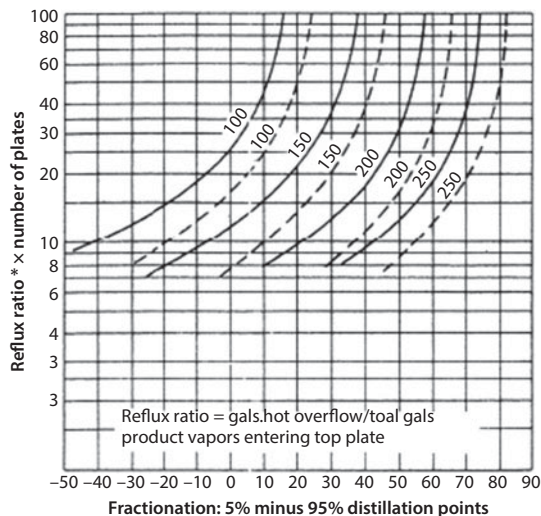
Chemicals are used to control corrosion by hydrochloric acid produced in distillation units. Ammonia (NH₃) may be injected into the overheads stream prior to initial condensation and/or an alkaline solution may be carefully injected into the hot crude-oil feed. If sufficient wash water is not injected, deposits of ammonium chloride (NH₄Cl) can form and cause serious corrosion. Crude feedstock may contain appreciable amounts of water in suspension which can separate during startup and, along with water remaining in the tower from steam purging, settle in the bottom of the tower. This water can be heated to the boiling point and create an instantaneous vaporization explosion upon contact with the oil in the unit.

Table 5.10 Some rules for design and operation of petroleum fractionators.

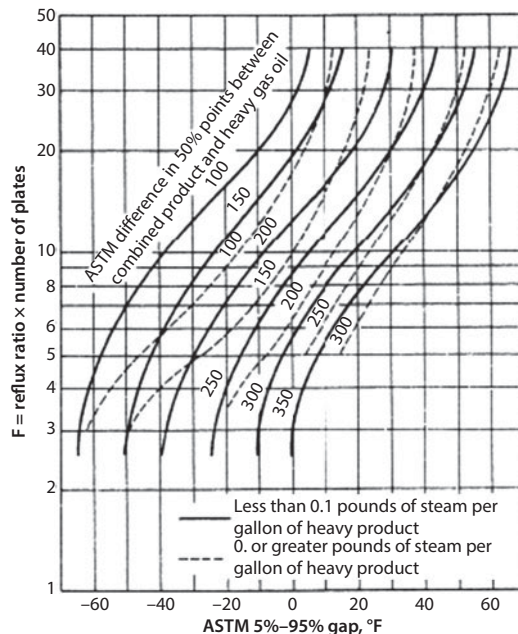
(a) Draw tray temperature T_{dt} as a function of the bubblepoint T_{bp} of the steam:

$$T_{dt} = \begin{cases} \exp(0.00407T_{bp} + 4.404), & 200 \leq T_{bp} + 325^\circ\text{F} \\ \exp(0.002952T_{bp} + 4.744), & 325 \leq T_{bp} + 600^\circ\text{F} \end{cases}$$

(b) Gap and overlap of top and sidestream products in terms of reflux and plates



(c) Gap and overlap between sidestream products in terms of reflux and plates



Numbers on the streams are °F differences between the 50% points of the streams. Dashed lines are with stripping steam, full ones without [Packie, *Trans. AIChE* 3, 51 (1941)].

(d) Number of trays between drawoffs

Separation	Number of trays
Light naphtha to heavy naphtha	6 to 8
Heavy naphtha to light distillate	6 to 8
Light distillate to heavy distillate	4 to 6
Heavy distillate to atmosphere gas oil	4 to 6
Flash zone to first draw tray	3 to 4
Steam and reboiler stripping sections	4

(e) Normal stripping steam usage

Product	lb steam/gal
Naphtha	0.2–0.5
Kerosene or diesel fuel	0.2–0.6
Gas oil	0.1–0.5
Neutral oils	0.4–0.9
Topped crude oils	0.4–1.2
Residual cylinder stock	1.0 up

(f) Superficial linear velocities in towers

Operation	Pressure (psia or mm)	Tray spacing (in.)	Superficial tower velocity (ft/sec)
Topping	17 lb	22	2.6–3.3
Cracking	40 lb	22	1.5–2.2
Pressure dist. rerun	20 lb	22	2.8–3.7*
Solution rerun	25 lb	22	2.8–3.5
Pressed dist. rerun	25 lb	22	2.8–3.9*
Pressed dist. rerun	60 mm	24	6.0–9.0
Vacuum	30 mm	30	9.0–12.0
Vacuum	90 mm	24	5.0–8.0
Stabilizer	160 lb	18	2.2–2.8
Nat. gaso. absorber	50 lb	14	1.0–1.3
Nat. gaso. absorber	400 lb	18	0.5–0.8

* Greatly dependent on quantity of steam.

(g) Pressure drop 0.1–0.2 psi/tray

(h) Overflash into tower feed zone is 2–5%

Health: Atmospheric and vacuum distillation are closed processes and exposures are expected to be minimal. When sour (high-sulfur) crudes are processed, there is potential for exposure to hydrogen sulfide (H_2S) in the preheat exchanger and furnace, tower flash zone and overhead system, vacuum furnace and tower, and bottoms exchanger. Hydrogen chloride may be present in the preheat exchanger tower top zones

and overheads. Wastewater may contain water-soluble sulfides in high concentrations and other water-soluble compounds such as ammonia, chlorides, phenol, mercaptans, etc., depending upon the crude feedstock and the treatment chemicals. Therefore, safe work practices and the use of appropriate personal protective equipment may be needed for exposures to chemicals and other hazards such as heat and noise, and during

Table 5.11 Troubleshooting checklists for crude unit.

<p>Decrease fractionation</p> <p>Reduced ASTM gap</p> <p>Flooding: This is caused when a <i>high feed rate</i> overloads the system's capacity for removing the bottoms, and results in subsequent increase in the liquid level. If this rises into the tray sections, the trays will flood. Also, when the <i>temperature gradient</i> decreases and <i>pressure drop</i> (ΔP) either increases or decreases across the troubled section of the tower, an abnormal operation will occur as the tray becomes overloaded with liquid and vapor. ΔP increases when the trays are flooded but decreases when the trays are dry. Flooding can also result from a decrease in <i>overall tower pressure</i>. This causes an increase in the <i>vapor rates</i> which carry liquid up the tower. Vapor rates can also increase if there is a <i>high temperature</i> in the <i>bottom of the tower</i>. Another possible cause of flooding is when the <i>bottoms level control</i> allows the level in the bottoms of the tower to increase until it reaches the tray sections, the liquid will fill the trays; or if the <i>internal reflux rates</i> attempting to flow down the tower are <i>very high</i>. Flooding can occur if the <i>feed rate</i> is higher than the tower is capable of handling under the existing operating conditions.</p> <p>Upset tray decks: This occurs when <i>dry trays</i> do not have enough liquid to function normally and physically damaged or upset trays cannot function normally. One cause of tray damage would be due to <i>slugs of water</i> entering the tower that is operating at a temperature above the boiling point of water. Since <i>tower temperature</i> is above the boiling point of water, the slugs explosively vaporize, creating a <i>pressure surge</i> that damages the trays. Trays can become dry when either the <i>external or internal reflux rate</i> is too low.</p> <p>Pumparound rate too high: This causes the internal reflux rate to decrease enough to cause dry trays.</p> <p>Top trays corroded: This is when upset trays have been physically damaged as may be caused by extreme pressure surges through the tower. Metal corrosion weakens a tray's construction and physically damages the tray. Damaged or upset trays cause the temperature gradient and the pressure drop to decrease approaching zero.</p> <p>Water in reflux</p>	<p>Overhead corrosion</p> <p>Desalter efficiency Caustic injection Reflux drum water pH Corrosion control chemicals</p>
<p>Inadequate Steam Stripping</p> <p>Long front end on product ASTM Operators saving steam Cold stripper feed Water in steam Plugged vapor outlet Stripper trays upset</p>	<p>Preflash Tower</p> <p>Redistill preflash naphtha Reduce furnace duty Increase unit capacity</p>
<p>Energy Wasters</p> <p>Leaking trapout tray Pumparound rate too low Bottoms sediment and water (BS & W) in crude Low exchanger velocities Caustic injection in exchangers Air leaks in furnace skin</p>	

Table 5.12 Typical CDU products, end boiling points and dispositions.

Product	End point °F/(°C)	Yield, wt% of crude	Disposition
Light ends (off gas)	50 °F (10 °C)	2.3	LPG
Light straight run naphtha	158 °F (70 °C)	6.3	Naphtha hydrotreating
Medium naphtha	356 °F (180 °C)	14.4	Naphtha hydrotreating
Heavy naphtha	392 °F (200 °C)	9.4	Distillate hydrotreating
Kerosene	464 °F (240 °C)	9.9	Distillate hydrotreating
Atmospheric gas oil	698 °F (370 °C)	15.1	Fluid catalytic cracking
Reduced crude	–	42.6	Vacuum distillation unit

sampling inspection, maintenance and turnaround activities.

References

- Nelson, W. L., *Petroleum Refinery Engineering*, 4th ed., McGraw-Hill Series in Chemical Engineering, 1958.
- Haddad, H. N., and D. B. Manley, "Improve crude oil fractionation by distributed distillation", *Hydrocarbon Processing*, pp 93–108, May, 2008.
- Ptak, C., Bonfils, P., and C. Marty, "Distillation Absorption and Stripping in the Petroleum Industry", Chapter 5, in "Separation Processes", *Petroleum Refining*, Vol. 2, Wauquier, P., ed., TECHNIP, France, 2000.
- Kaes, G. L., *Refinery Process Modeling: A Practical Guide to Steady State Modeling of Petroleum Processes*, 1st ed., Kaes Enterprises, Inc. Mar. 2000.
- Manjoorana, Koch, B.S., *Modern Petroleum Chemistry: An Overview*, Kannatheri Publications, Karla, India, 2003.
- Edmister, W. C., *Applied Hydrocarbons Thermodynamics*, Gulf Publishing Co., Houston, Texas, 1961.
- Maxwell, J. B., *Data Book on Hydrocarbons*, Princeton, N. J., Van Nostrand 1968.
- Srikumar Koyikkal, *Chemical Process Technology and Simulation*, PHI Learning Private Ltd., Delhi 2013.
- Murphree, E. V., *Ind. Eng. Chem.* Vol. 17, p 747, (1952).
- Drickamer and Bradford, *Trans. Am. Inst. Chem. Engrs*, Vol. 39, p 319, 1943.
- O'Connell, H. E., *Trans. Am. Inst. Chem. Engrs.*, Vol. 42, p 741 1946.
- UniSim Design R443, Honeywell Process Solutions, Calgary, Alberta, Canada, 2016.
- Seader, J. D. and Ernest, J. Henley, *Separation Process Principles*, 2nd ed., John Wiley & Sons Inc. 2006.
- Fahim, M. A., Al-Sahhaf, T. A., and A. S. El-Kilani, *Fundamentals of Petroleum Refining*, Elsevier, 2010.
- Lieberman, N. P., *Troubleshooting Process Operations*, 2nd ed., PennWell Publishing Co., 1985.
- Lieberman, N. P., and E. T. Lieberman, *A Working Guide To Process Equipment*, 3rd ed., McGraw-Hill, Co., 2008.
- Parkash, Surinder, *Refining Processes Handbook*, Gulf Professional Publishing, Elsevier, 2003.
- Nelson, W. L., "Regulation of IBP and EP", *Oil & Gas Journ.*, p. 143, August 25, 1945.

6

Thermal Cracking Processes

Introduction

Thermal cracking is the cracking of short and long chain residues under severe thermal conditions. The liquid products from processes are highly olefinic, aromatic and have high-sulfur content. They require hydrogen treatment to improve their properties. Coking is the process of carbon removal from the heavy residues in producing lighter components that are lower in sulfur as most of the sulfur is retained in the coke. The thermal treatment of hydrocarbons involves a free-radical mechanism where reactions take place in the initiation step. The reactions in the final step result in the formation of heavy fractions and coke.

There are three classes of industrial thermal cracking processes:

- Mild cracking (visbreaking)
- Delayed coking
- Severe thermal cracking.

The mild cracking involves sufficient heating to crack the residue just enough to lower its viscosity

and to produce some light products. Delayed coking requires moderate thermal cracking to convert the residue into lighter products, leaving coke behind. The third process requires severe thermal cracking in which part of the coke is burned and used to heat the feed in the cracking reactor, as in fluid coking. In another part of the process, steam is used to crack most of the coke (flexi-coking). The conditions for these processes are:

Visbreaking

Mild heating 880–920 °F (471–493 °C) at 50–200 psig
(3.4–14 bar)

Reduce viscosity of fuel oil

Low conversion (10%) at 430 °F (221 °C)

Heated coil or soaking drum

Delayed coking

Moderate heating 900–960 °F (482–516 °C) at 90 psig
(6.2 bar)

Soak drums 845–900 °F (452–482 °C)

Residence time: until they are full of coke

Coke is removed hydraulically

Coke yield ~ 30 wt%

Fluid coking and flexi-coking

Severe heating 900–1050 °F (482–566 °C) at 10 psig
(0.7 barg)

Fluidized bed with steam

Higher yields of light ends

Less coke yield (20% for fluid coking and 2% for
flexi-coking)

Vacuum Distillation

In refineries, the vacuum distillation unit (VDU) follows the atmospheric or the crude distillation unit (CDU). The bottom of the atmospheric distillation is known as the reduced crude or topped crude. The topped crude oil from the CDU is heated in a furnace and distilled at sub-atmospheric pressure to recover additional distillate and gas oil. The reduced crude bottoms from the atmospheric tower provide the feed to the vacuum column where the second stage of distillation takes place. In this stage, the heavier fractions (e.g., high boiling points) such as gas oil and lube oil are removed from the reduced crude without cracking taking place. Cracking does not occur in a vacuum column because the column has a large diameter and is operated at very low pressure, and subsequently boiling takes place at a low temperature. With boiling occurring at a low temperature, heavy fractions are distilled from the reduced crude. Superheated steam is often introduced at the bottom of the column to separate more of the heavy gas oil. Superheated steam causes large quantities of gas oil to boil off that otherwise would not have boiled off at the low temperature. Thus steam stripping eliminates the need to operate the vacuum column at high temperature, which could result in cracking of the reduced topped crude. Cracking often results in plugged trays due to coke deposition.

The reduced pressure enables materials to be extracted from the topped crude oil without using excessive temperatures and reduces the carryover of metals and carbon forming materials into the gas oil product. Vacuum distillation may be employed for distilling topped crude oils in the production of waxy distillate and cylinder stock; it is widely used to produce catalytic cracking plant feedstocks of low carbon content. The separation in a vacuum unit in gas oil recovery mode is the separation between vacuum residue and heavy gas oil. This separation takes place in the flash zone of the column and is controlled by the flash zone pressure and temperature, which are determined by the flash vaporization characteristics of the topped crude oil feed.

Two vacuum distillation operation types are available in refineries. The most common operation extracts gas oil/long residue for charge to downstream cracking units in the refinery where it is converted to light gases and liquids, gasoline and heating oil. The vacuum distillation unit is referred to as fuels type. The second type of operation extracts petroleum cuts from the topped crude oil that are suitable for production of lubricating oils. This column is referred to as lubes types. Vacuum distillation columns are usually designed for a limited number of products. A column designed for one set of operations may not be suitable for other products.

There are two types of vacuum distillation columns based on operation. These are “wet type” and “dry type” as shown in Figure 6.1. The wet type unit uses steam to reduce the partial pressure of oil in the flash zone of the column to the required level. The dry type unit depends solely on the effectiveness of the vacuum inside the column to vaporize the heavy oil. It has a boot cooler since the flash zone is hotter than a wet unit for the same service. Usually, ejectors are used in the tower overhead to withdraw vapors and create a vacuum. The wet type unit requires a huge quantity of steam, which is dependent on the amount of vacuum.

The wet vacuum type has a pre-condenser to remove excess water from the column overhead prior to being fed to the ejectors. There is always a back pressure on the column overhead equal to the vapor pressure of water at the condensing temperature in the pre-condenser. The total steam injected into the coil plus stripping zone is in the range of 0.3 to 0.5 lb/gallon of vacuum residue (36 to 60 kg/m³) [1]. The dry vacuum type has a higher flash zone temperature than the wet vacuum unit for the same service, and as it provides a boot cooling circuit to keep the column boot from coking and becoming plugged. The boot cooler subcools the liquid from the flash zone and prevents coking.

Both units have a wash grid above the flash zone; the feed to the column enters the flash zone at very high velocity, and a high amount of heavy liquid is entrained in the flash zone vapor. The heavy gas oil that is returned to the column over the wash grid washes down the entrained liquids. Metals and con-carbon are also washed back in the grid.

Because of the high boiling points of lubricating oil stocks, the use of vacuum alone is seldom sufficient. Process steam must also be used, and its amount is dependent upon the boiling range of the stock, and the quantity vaporized. The dry process of vacuum distillation, which uses no steam, has many theoretical

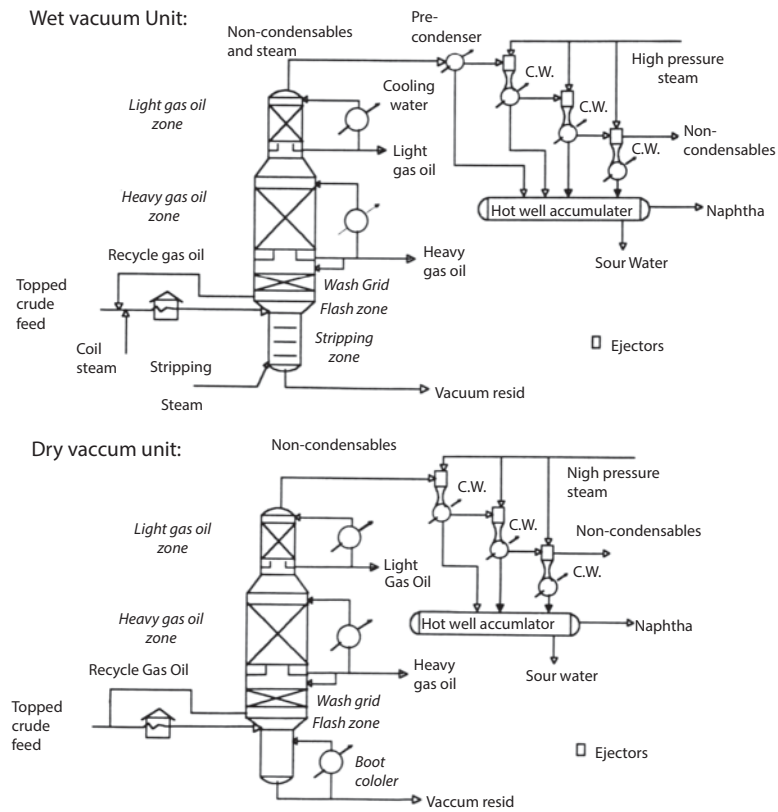


Figure 6.1 Wet and dry vacuum units (Source: Keas, Gerald L., *Refinery Process Modeling- A Practical Guide to Steady State Modeling of Petroleum Processes*, 1st ed., The Athens Printing Company, Athens, Georgia, 2000).

advantages. Most important among these are the much smaller tower and condensing equipment required. The plates have a low-pressure drop.

The pressure drop that occurs between the barometric condenser and the vaporizer section of the column is essential, as the purpose of vacuum operation is to produce a low effective pressure at the vaporizer, and thus the vacuum must not be lost by excessive friction loss through the vapor line, condensers and column plates. Avoiding a few millimeters (mm) of pressure drop from the barometric to the vaporizer can save many pounds of process steam as the saving in the quantity of steam is important. But the reduction in column diameter and the quantity of cooling water can be significant. In an effort to achieve a minimum pressure drop, many arrangements and designs of vacuum columns and condensing equipment have been developed. The plates are designed for as low a liquid head above the slots of the caps as possible. In some installations, the vapor line has been eliminated by performing the condensing in the top of the column [2]. The operation of vacuum column is similar to that of crude oil distillation (atmospheric) column with refluxes, side strippers, pumparounds, steam injection, etc., except that the operation is under

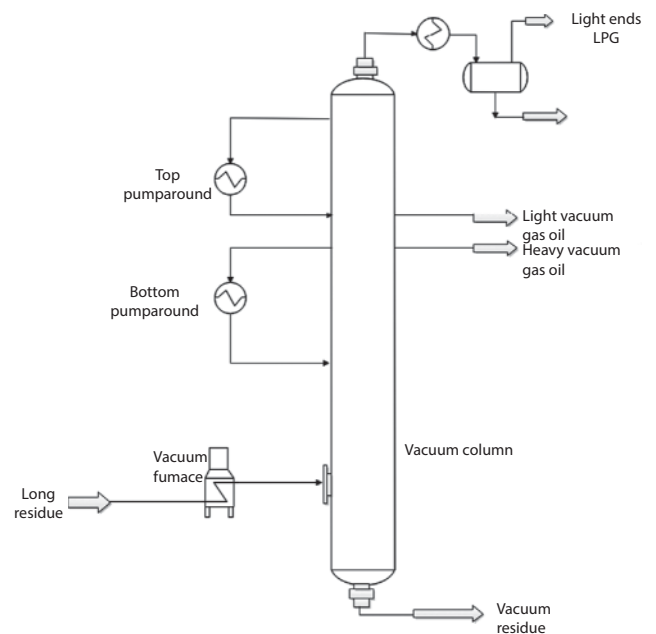


Figure 6.2 Process flow diagram of the vacuum distillation unit.

vacuum conditions. Figure 6.2 shows a schematic of high-vacuum distillation column for processing long residue to waxy distillate and short residue, respectively.

This process has more internal reflux, and the side products are drawn to meet specified viscosities and other related properties that are important for lubricating oils. Not all topped crude oil is suitable for the production of lubricating oils. For asphalt type crude oils, the vacuum column bottoms product is used to make the road asphalt. For other types of crude oils, the material is charged to a coking process, where it is cracked to petroleum coke and low-grade gas oils. The gas oils from the coking process must usually be treated to remove sulfur and nitrogen before they are suitable for charge to cracking units.

6.1 Process Description

The furnace outlet temperatures required for atmospheric pressure distillation of the long residue or heavier fractions of crude oil are so high that thermal cracking would occur with the resultant loss of product and equipment fouling. These materials are therefore separated under vacuum because the boiling temperature decreases with a lowering of the pressure. Distillation is carried out with an absolute pressure in the tower flash zone area of 25 to 40 mm Hg. To enhance vaporization, the pressure is lowered even further to (10 mm Hg or less) by the addition of steam to the furnace inlet and at the bottom of the vacuum tower. Addition of steam increases the furnace tube velocity and reduces the coke formation in the furnace as well as decreasing the total hydrocarbon partial pressure in the vacuum tower. The amount of stripping steam used depends upon the boiling range of the feed and the fraction vaporized, but is between 10–50 lb/bbl feed. The furnace outlet temperatures are also a function of the boiling range of the feed, and the fraction vaporized as well as the feed coking characteristics. Generally, high tube velocities and steam addition reduce coke formation and furnace outlet temperatures are in the range of 730–850 °F (388–454 °C).

The feed enters the vacuum tower at the lower part of the column. As in the case of atmospheric distillation, a 3–5 vol% overflash is maintained (i.e., 3–5 vol% vapors are produced more than the total products withdrawn above the flash zone). This is to provide some fractionation between the high-vacuum gas oil (HVGO) draw-off tray and the flash zone, thereby controlling its end point. The distillate is low vacuum gas oil (LVGO) and two other cuts, namely medium vacuum gas oil (MVGO) and high-vacuum gas oil (HVGO). The two cuts of MVGO and HVGO are essential to extract heat

from the tower at a more advantageous level from the HVGO pumparound.

Vacuum distillation columns are equipped with packing for fractionation, and heat exchange zones. This is in order to reduce the pressure drop in the column, which is important for creating a low vacuum in the lower section of the column. The bottom zone is equipped with valve trays. The vapors from the flash zone rise up a wash and fractionation zone where the sections are condensed with HVGO reflux. Further up the column sections (consisting of a heat exchange and fractionation zone) are separated by sprays of liquid from the pumparound or the internal reflux.

A vacuum column is an essential component of most crude distillation units. The vacuum in these columns is usually created by a series of steam jet ejectors that use ~ 100 psi (6.9 bar) steam. To obtain the design vacuum from ejectors, the design steam pressure must be maintained. Since the ejector internals are not adjustable, the steam flow is not throttled otherwise, the steam pressure will be lost, and therefore, the ejector steam use is fixed [3].

6.2 Steam Jet Ejector

The ejector gas load consists of two sources: air in-leakage and uncondensed gas. The amount of air sucked into the system is independent of throughput. The uncondensed gas that results from thermal cracking of the vacuum column charge in the preheat furnace is proportional to the load on the ejector interstage condensers and hence the feed rate. If an ejector is not overloaded at a normal gas rate, reducing the gas load will not result in the greatly improved vacuum. The ejector is simply oversized at the lower charge rate and wastes steam without obtaining any appreciable benefit in lower vacuum tower pressure.

Steam jet ejectors are employed to recompress low-pressure steam to a higher-pressure steam. They are sometimes used to compress low-pressure hydrocarbon vapors to higher-pressure hydrocarbon gas. The convergent-divergent steam jet is rather like a two-stage compressor with no moving parts [4]. Figure 6.3 shows a simplified steam jet ejector, where high-pressure motive steam enters through a steam nozzle. As the steam flows through this nozzle, its velocity greatly increases as it flows to the condenser. The condenser condenses the steam at a low temperature and low pressure. The steam accelerates toward the cold surface of the tubes in the condenser, where its large volume will disappear as

the steam turns to water. The motive steam accelerates to such a great velocity that it can exceed the speed of sound (i.e., sonic velocity). This high increase in velocity of the steam represents a tremendous increase in kinetic energy of the steam. The source of this kinetic energy is the pressure of the steam.

As the high-velocity steam enters the mixing chamber (Figure 6.3), it produces an extremely low pressure. The

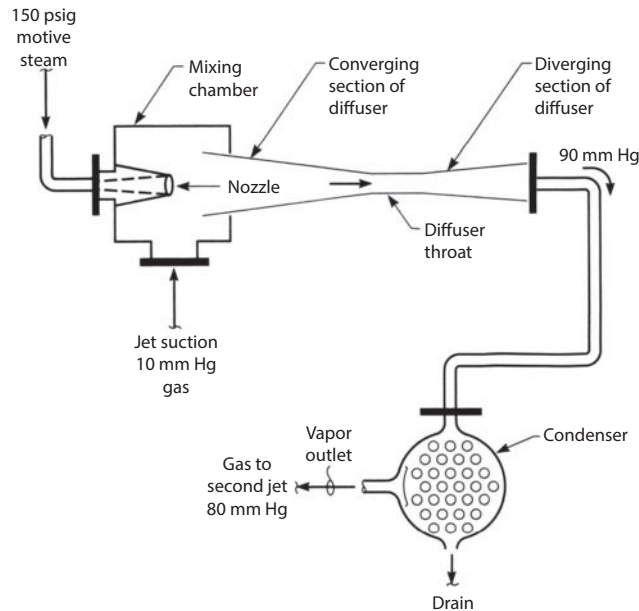


Figure 6.3 A convergent-divergent steam jet (Source: Norman P. Lieberman and Elizabeth T. Lieberman, *A Working Guide to Process Equipment*, McGraw-Hill Companies, Inc., 2008).

gas flows from the jet suction nozzle and into the low-pressure mixing chamber. The rest of the jet is used to boost the gas from the mixing chamber up to the higher pressure in the condenser, which is carried out in two compression steps: converging and diverging.

Vacuum distillation units have a system to create the vacuum that uses either ejectors or a combination of ejectors and liquid ring pumps. Ejectors recompress the gases through a nozzle where vapors from the column are sucked into the venturi section of the nozzle by a stream of medium- or low-pressure steam. The vapor phase at the ejector exit is partially condensed in an exchanger with cooling water. The liquid phase flows to the overhead drum. The vapor phase goes from the condenser to another ejector-condenser stage.

Liquid ring pumps are similar to rotor gas compressors. One pump can replace two or three stages of ejectors in dry or wet type vacuum distillation. They do not use steam and can therefore reduce hydrocarbon-rich aqueous condensates in a system using ejectors. Systems with ejectors are flexible and easy to operate. The higher investments required by liquid ring pumps are offset by steam consumption and lower installation costs. Figure 6.4 shows schematic of a vacuum distillation unit for the production of waxy distillate for the hydrocracker unit and short residue for the visbreaker unit and an ejector for recompressing the gas sent to the furnace. The topped crude oil feeds to vacuum units have typical boiling ranges from heavy kerosene ~500 °F (260 °C) through high

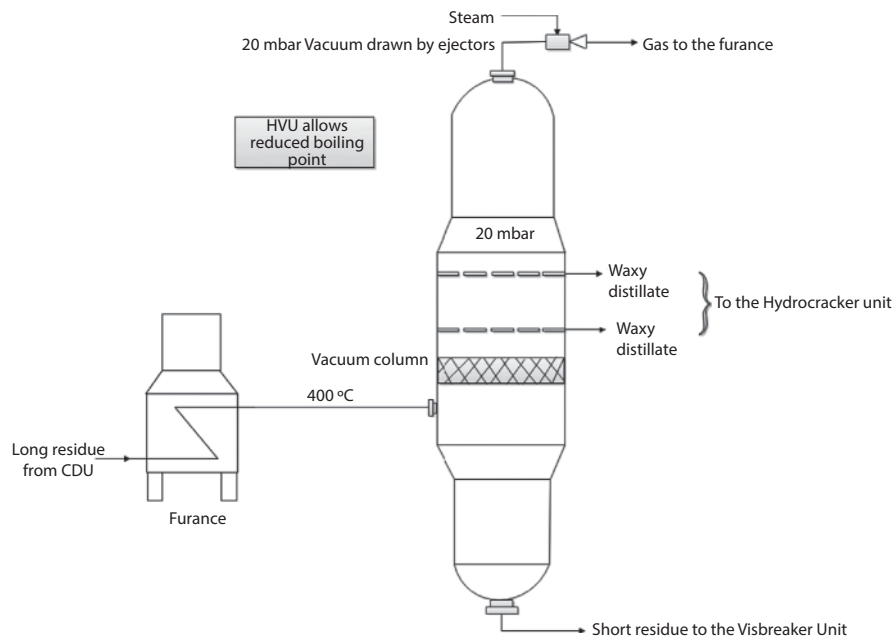


Figure 6.4 A schematic of high vacuum unit.

boiling residuum (Bpt. 1600–2000 °F (871–1094 °C)), depending upon the °API gravity of the crude oil. There are traces of dissolved light hydrocarbon gas in the topped crude. The overhead product from the vacuum column comprises light hydrocarbon gases; nitrogen, oxygen, hydrogen sulfide and light hydrocarbon liquids commonly referred to as vacuum naphtha. The nitrogen and oxygen enter the overhead system through leaks. Most of the light hydrocarbon gases and vacuum naphtha are the results of thermal cracking of the topped crude oil feed in the vacuum furnace.

Figure 6.5 illustrates the product separation from a typical vacuum unit. The True Boiling Point (TBP) cut-point between the heavy gas oil and topped crude is lower than the TBP end point for the heavy gas oil. The TBP cut-point shows the temperature for a perfect separation between the heavy gas oil and the vacuum resid. The maximum boiling point for components that distribute between these two products is 1100 °F (593 °C). This temperature represents about 29 liquid volume (LV) percent of the vacuum resid. Thus, it is essential that the TBP boiling point curve for the first 29 LV percent of the vacuum resid is accurate since these materials are in the separation zone between heavy gas oil and vacuum resid. The separation in a vacuum

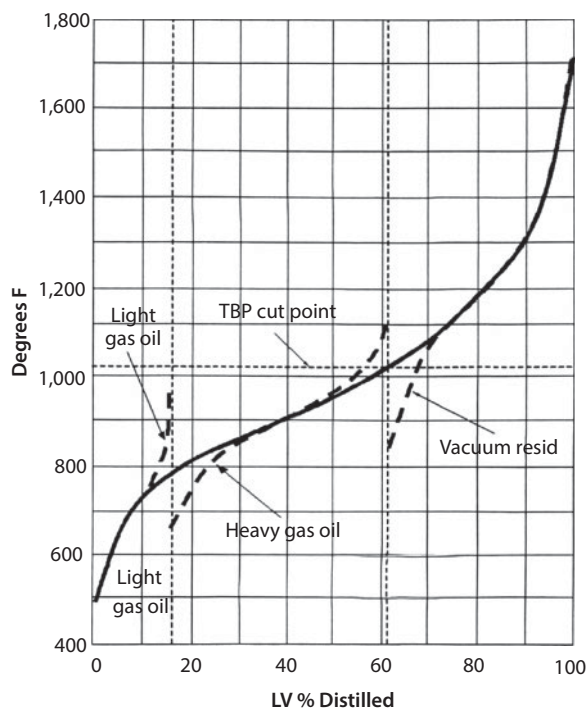


Figure 6.5 Vacuum unit feed and True Boiling Point distillations (Source: Keas, Gerald L., *Refinery Process Modeling - A Practical Guide to Steady State Modeling of Petroleum Processes*, 1st ed., The Athens Printing Company, Athens, Georgia, 2000).

unit in gas oil recovery mode is the separation between vacuum resid and heavy gas oil. This separation occurs in the flash zone of the column and is controlled by the flash zone temperature and pressure. These parameters are determined by the flash vaporization characteristics of the topped crude oil feed.

Figure 6.6 illustrates a schematic of a vacuum distillation unit showing the ancillaries such as cooling water and overhead and Figure 6.7 shows a photograph of mild vacuum distillation column for processing long residue to waxy distillate and short residue to the visbreaker unit.

The column simulation steps are similar to those of atmospheric column. The major operating parameters are as shown [5], and typical yields and dispositions are shown in Table 6.1.

Top pressure	= 12 to 15 mmHg
Temperature at the top	= 225 to 250 °C
Temperature of reduced crude (in the flash zone)	= 350 to 400 °C
Pressure in the flash zone	= 30 to 40 mmHg
Steam rate	= maximum 5 kg per barrel
Overflash	= 2%

The common problems associated with operating a typical vacuum column as shown in Figure 6.7a are [3]:

- High flash-zone pressure.
- Black gas oil
- Excessive production of trim gas oil
- High-gravity resid.
- Ejector deficiencies.
- Bottoms-pump net positive suction head (NPSH).
- Low gas-oil draw temperatures.
- Transfer-line failures.

6.3 Pressure Survey in a Vacuum Column

The reduction of resid in a vacuum column is dependent on the flash-zone temperature and pressure. A rise in the pressure increases the production of resid at the expense of the more valuable gas-oil product. Troubleshooting flash-zone pressure problems require a survey of the vacuum column. Pressures are best measured with a portable mercury-filled vacuum manometer. Using a vacuum pressure gauge may reduce the accuracy of observed pressure drops, and relying on permanent installed gauges for pressure drop data may not provide reliable results. Figure 6.7b summarizes two vacuum-column pressure surveys: one just after start-up and the other a year into the run,

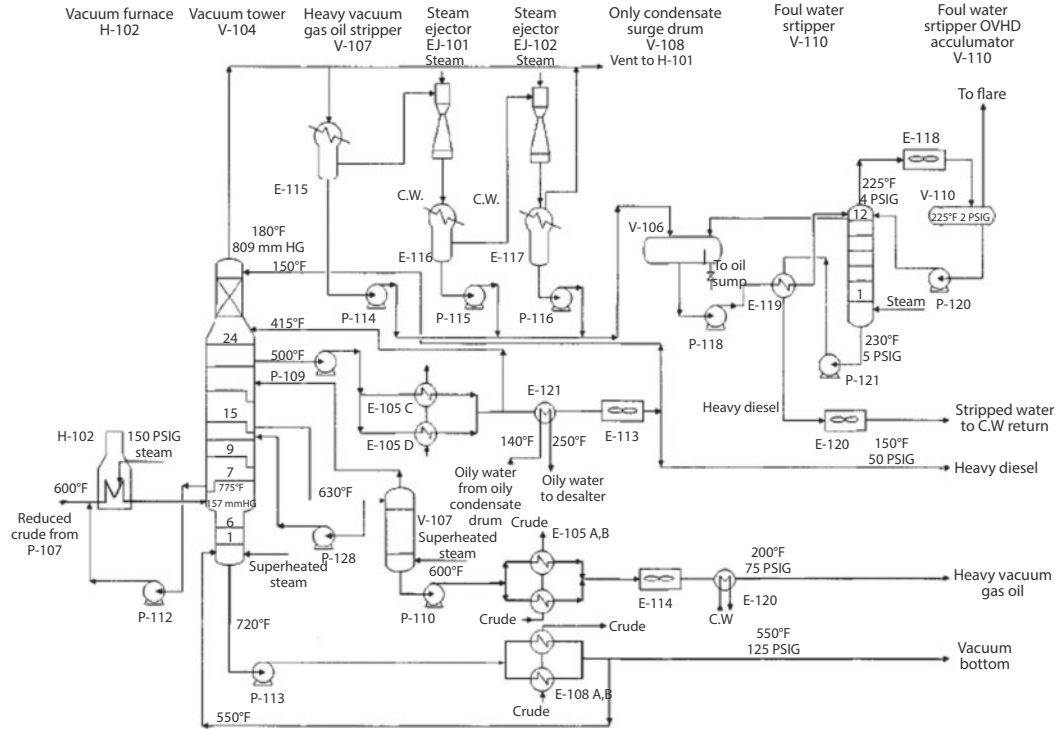


Figure 6.6 Process flow diagram of vacuum distillation unit. CW = cooling water, OVHD = overhead. (Source: Surinder Parkash, *Refining Processes Handbook*, Gulf Professional Publishing, 2003).

Table 6.1 Yields and disposition of the VDU process.

Product	Yield, wt% of crude	Disposition
Light ends	<1	LPG
Light Vacuum Gas Oil (LVGO)	17.6	Distillate hydrotreater
Heavy Vacuum Gas Oil (HVGO)	12.7	Fluid catalytic cracking
Vacuum residue (Resid)	12.3	Coking



Figure 6.7 A photograph of the mild vacuum column, crude distillation tower with associated pumps, accumulators and piping.

where the data showed that the demister is partially plugged with coke [3].

The pressure drop is normalized by correcting for flow rates and pressure as:

$$\Delta P_n = \Delta P_1 \left(\frac{M_1 \times V_1}{M_B \times V_B} \right)$$

where

M_1 = Mass flow through the column

V_1 = Superficial velocity through the column

M_B = Mass flow of the base data to which ΔP_1 is to be compared

ΔP_1 = Measured pressure drop

ΔP_N = Normalized pressure drop

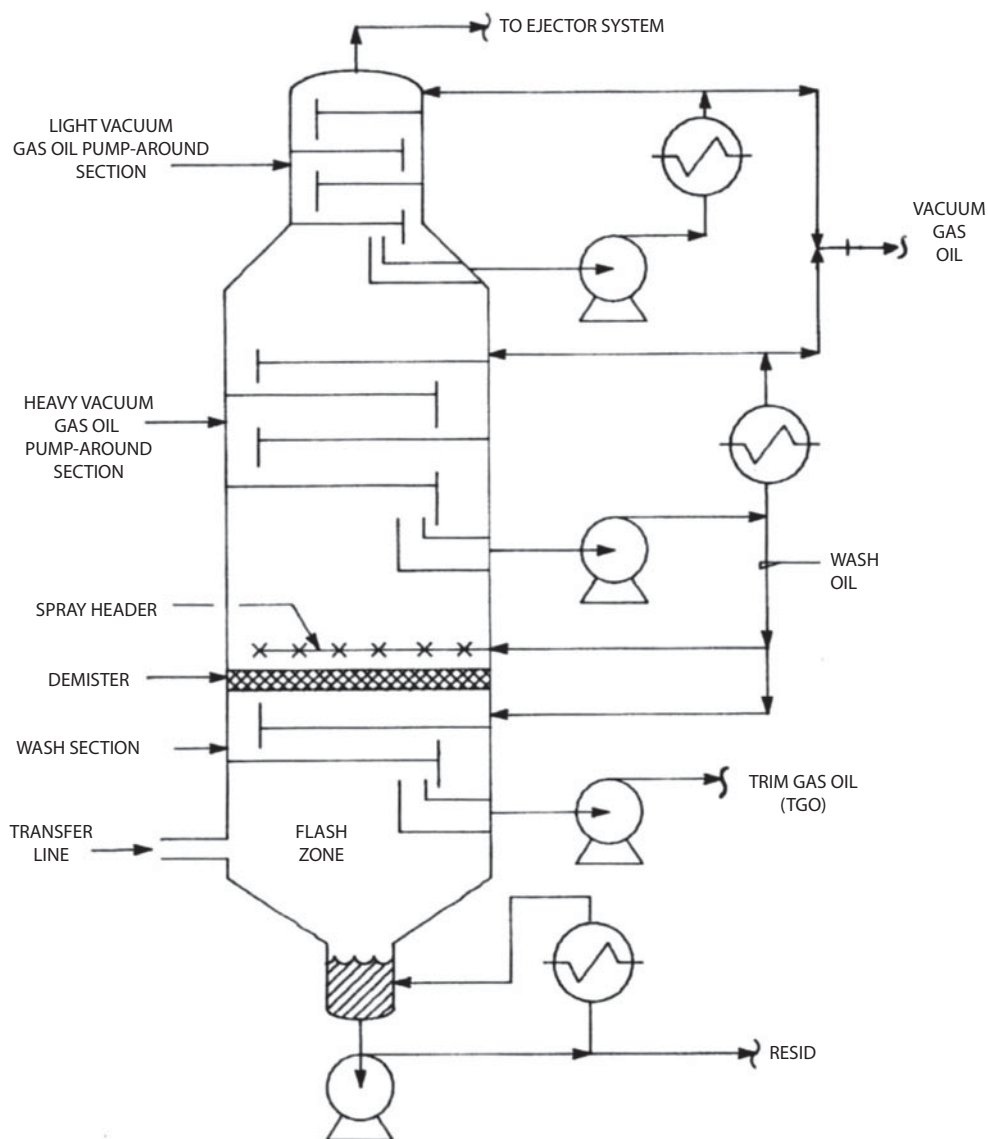


Figure 6.7a A typical vacuum column (Source: Norman P. Lieberman, *Troubleshooting Process Operations*, 2nd ed., PennWell, 1985).

Any restriction to vapor flow above the flash zone would increase the flash-zone pressure. An increase in ΔP across the wash trays below the demister or across the demister is caused by coke formation, which can only be corrected by a complete shutdown.

Flooding is caused by a large increase in ΔP across the top or bottom pumparound trays and a reduction in liquid pumparound rate could reduce the problem. A high vacuum-column top pressure is caused by air leaks, excessive production of hydrocarbon gases due to thermal cracking, or ejector deficiencies. Table 6.2 provides troubleshooting checklist for vacuum columns:

6.4 Simulation of Vacuum Distillation Unit

Simulating a vacuum distillation unit (VDU) starts with data collection shown in Table 6.3; Ai-Fu Chang *et al.* [15] have simulated a simplified and rigorous model of the VDU based upon operating and analysis data collected for a short period of 1–3 days. Providing adequate simulation of the VDU requires translating a real distillation column into a theoretical configuration. This is because the high vapor velocities and low liquid levels of vacuum column stages make the performance of a real VDU to deviate from that predicted by an ideal vapor-liquid equilibrium. Furthermore,

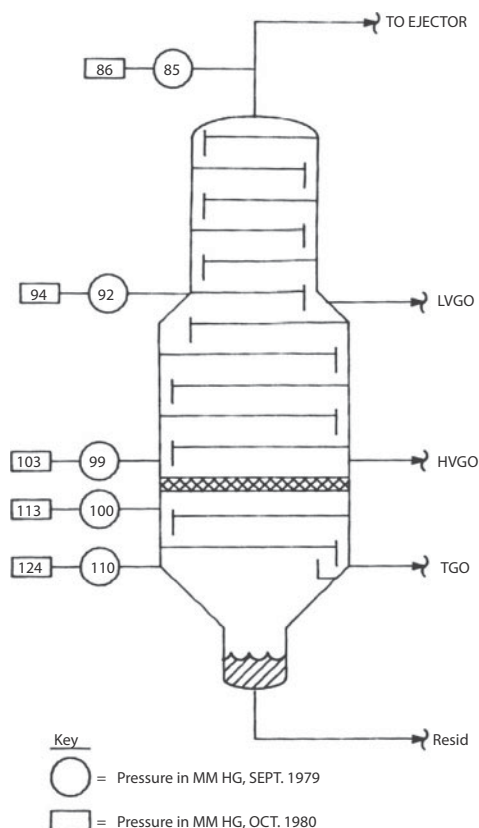


Figure 6.7b Pressure survey in troubleshooting high flash-zone pressure (Source: Norman P. Lieberman, *Troubleshooting Process Operations*, 2nd ed., PennWell, 1985).

the packing section of VDU behaves as a heat-transfer facility rather than a separation unit, thereby making the separation performance difficult. The product distribution of VDU depends on the composition of atmospheric residue rather than the extent of fractionation. Therefore, simulating a VDU with side products requires less than ten equilibrium stages. In building VDU simulation, the column model does not readily converge because of the low liquid flow in the column. Kaes [1] suggests a two-stage approach to simulate VDU properly, namely: simplified and rigorous simulations. A simplified model can produce quick understanding of a real VDU and particularly for a preliminary study of revamping. Additionally, the model from this approach provides good estimates to a rigorous simulation if the column convergence is difficult.

An essential application in simulating VDU is to optimize the deep-cut operation to process heavier crude. This is because the growing demand of the refiners to process heavier crude feeds. Deep-cut operation is expected to improve the economics by increasing the cut point of heavy vacuum gas oil

(HVGO) higher than 1050 °F (566 °C) to produce more gas oil for downstream units such as fluid catalytic cracking (FCC). In practice, there are four schemes and corresponding actions to perform VDU deep-cut revamping to increase the HVGO yield [15].

1. Increase feed vaporization
 - Raise flash-zone temperature
 - Reduce flash-zone pressure
2. Increase distillate strip-out from residue (if column is steam-stripped)
 - Optimize stripping steam
3. Decrease overflash while maintaining high-quality washing of the vapors rising from the flash zone
 - Reduce wash oil
 - Optimize slop wax recycle
4. Increase vapor-liquid separation in the flash zone
 - Optimize mechanical design of distillation column

The residue obtained from a vacuum tower is suitable for delayed coking.

6.5 Coking

Coking is a thermal cracking process as the operation is often considered to be the last stage in the refining since the heaviest fraction (pitch or tar) is converted into very useful products. Coking is a process by which the vacuum residue obtained from vacuum column is processed to making carbon electrodes. The different coking types are: delayed coking, fluid coking, flexi-coking and contact coking. The process of coking is rather complex involving batch and continuous operations as it produces solid, liquid and gaseous products.

6.5.1 Delayed Coking

The process objective is to convert low-value residue to valuable products such as naphtha, diesel and coker gas oil. This process occurs in a large vessel at a slow pace (delayed), and it is the most important process among the various coking methods (the precursor to delayed coking is the two-coil cracking process). It is capable of cracking all types of feed materials, including solvent extracts. Thermo-cracking increases the hydrogen/carbon ratio by carbon rejection in a semi-batch process. The process has a high decarbonising efficiency (see Table 6.16).

Table 6.2 Troubleshooting checklist for vacuum towers [3].

Bottoms pump NPSH	Transfer-line failures	High flash-zone pressure
Insufficient quench Overflow to TGO pan Too much gland oil pressure Leaking seal Suction screen plugged Air leak in suction piping	Approach to sonic velocity Erosion due to high velocity Reduced flash-zone pressure Lighter feed More velocity steam Increased charge rate Furnace tube peaking Temperature Naphthenic acid in crude	Tower pressure survey Normalized pressure survey Coke build-up on demister Flooding of PAR trays Ejector deficient Excess thermal cracking
Black gas oil	Ejector problems	Excessive production of trim gas oil
Indicates metals in FCU feed Demister section upset Demister pad partially coked Too low a flash-zone pressure Wash oil flow too low	Air leaks (CO, CO ₂ , or O ₂) Noncondensable hydrocarbons Worn ejector internals Low motive steam pressure of temperature Wet motive steam Fouled condenser	Symptom of wash oil section problems Leaking HVGO drawoff tray
Low pumparound draw temperatures	Projects to improve gas-oil recovery	Light resid
Low HVGO temperature HVGO draw-off tray leaking Low HVGO and LVGO LVGO drawoff tray leaking	Reduce light gas oil in vacuum tower feed. Reduce number of wash trays Replace PAR trays with packing Colder cooling water for ejector condensers Seal weld HVGO and TGO draw-off trays. Increase the number of bottom-stripping trays. More superheat of exhaust stripping steam.	Inadequate velocity steam High flash-zone pressure Low flash-zone temperature Leaking TGO draw-off pan Stripping steam too low Stripping trays upset

The feed to the delayed coker can be any undesirable heavy stream that contains high metal content. This could be from a vacuum residue, a fluid catalytic cracking slurry and visbreaking tar (residues). The products from the coker are unsaturated gas ($C_1 - C_4$), olefins ($C_2^= - C_4^=$) and iC_4 . The olefins are very desirable feedstocks to the petrochemical industry. Isobutane (iC_4) and olefins are sent to the alkylation units, and the C_3/C_4 gases are sent to the LPG plant. The coker unit is the only unit in the refinery that produces coke. The highly aromatic naphtha does not require reforming and is sent to the gasoline pool. Light coker gas oil is hydrotreated and sent to the kerosene pool. Heavy coker gas oil is sent to the FCC for further cracking.

The principal role of the delayed coker unit is to handle very heavy undesirable streams and to produce desirable products; the overall refining yield of light products increases as a result of coke removal.

In delayed coking process, heating is carried out in the furnace to initiate cracking, and the chemical reactions are completed in huge and tall coke drums. Several coke drums in series are operated in a cyclic manner. While one drum is being filled, the other drums are in the process of coking and decoking. By orderly rotating of the drums, the process can be termed continuous, and a minimum of two drums are essential even for small capacity plants. Superheated feed in a large coke drum is flashed where the coke remains, and vapors

Table 6.3 Data requirement of VDU model.

Flow rate
<ul style="list-style-type: none"> • Feed and product streams (Overhead products are bonus) • All pumparound streams • All cooling streams for pumparounds • Coil and strip streams
Pressure
<ul style="list-style-type: none"> • Flash zone • Top of column • Bottom of column
Temperature
<ul style="list-style-type: none"> • Flash zone • Top of column • Bottom of column • Side product draw tray • Furnace inlet and outlet temperature • Transfer temperature • Draw and return temperatures for all pumparound • Inlet and outlet temperature of all pumparound cooling streams
Analysis
<ul style="list-style-type: none"> • Distillation and gravity of atmospheric residue (Feed) • Distillation and gravity for all product streams • Compositional analysis of overhead gas

leave the top and returns to the distillation column. The heavy oils and light oils are recycled in different ratios to maximize the yield of either coke or distillates as per the requirement. The off-line coke drum is drilled, and the petroleum coke is removed via hydro-jetting. Table 6.4 shows the effect of parameters on the yields.

The expected yield of coke may be ~ 30% for reduced crudes or 80% for tars and pitches. Coke from these units contains volatile matter up to 8–15%, and the bulk density of the coke obtained may be around 9 kg per liter. CDE (Conradson Decarbonizing Efficiency) of the plant may be reaching up to 99.8% [5]. The conditions and parameters in delayed coking are given:

Heavy oil, discharge temperature, °C	470–520
Coking temperature, °C	450–470
Pressure in coke drums, atm.	5–6
Drum diameter, m.	4–5
Drum height, m.	14–20
Thickness of drum walls, mm	~40

The following licensors have provided the technologies for the delayed coking method:

- ABB Lummus Global
- Conoco Philips
- Exxon Mobile Research
- Foster Wheeler/UOP LLG

The delayed coker unit operation consists of the following operations.

1. Feed preheat
2. Coking
3. Primary fractionation
4. Vapor recovery
5. Coke drum steamout/Blowdown
6. Decoking
7. Green coke handling.

The delayed coker unit is designed to produce the following products:

1. Coker gas
2. Coker LPG
3. Coker naphtha
4. Light Coker gas oil (LCGO)
5. Heavy Coker gas oil (HCGO)
6. Green coke

Figure 6.8 shows the schematic of the delayed coking process.

Figure 6.9 shows a simplified schematic flow diagram of a delayed coker, where hot resid feed flows to the bottom of the combination tower. The combination tower bottom section functions as a surge drum from which the coking heater is charged. The heater raises the resid temperature to 900 °F (482 °C). The resid then flows into the bottom of one of the pairs of coke drums where it thermally cracks to gas, gasoline, gas oil and solid coke. The coke gradually fills the drum normally over a period of 24 h while the lighter products pass on as vapor to the combination tower. Since the coking reaction is endothermic (i.e., absorbs heat), the vapors leaving the top of the coke drum are roughly 110 °F (43 °C) colder than the heater outlet temperature. In the combination tower, the coke drum vapors are condensed and fractionated into four products: gas, wild gasoline, furnace oil and heavy gas oil. Lieberman [4] provides the most commonly encountered problems during the batchwise filling and emptying of coke drums:

Table 6.4 Effect of parameter on yields [5].

Increased parameter	Gas yield	C ₅₊ (L) yield	Coke yield	HCGO quality
Pressure	Increases	Decreases	Increases	Improves
Recycle rate	Increases	Decreases	Increases	Improves
Coil temperature	Decreases	Increases	Decreases	Deteriorates
Velocity of medium	Decreases	Increases	Decreases	Deteriorates
Cycle time		Increases	Decreases	

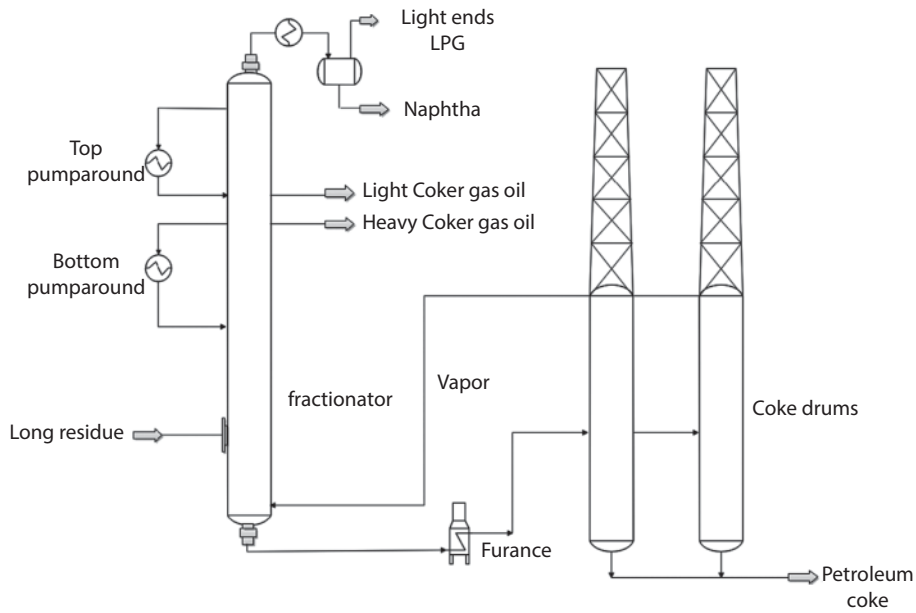


Figure 6.8 Process flow diagram of the delayed coking unit.

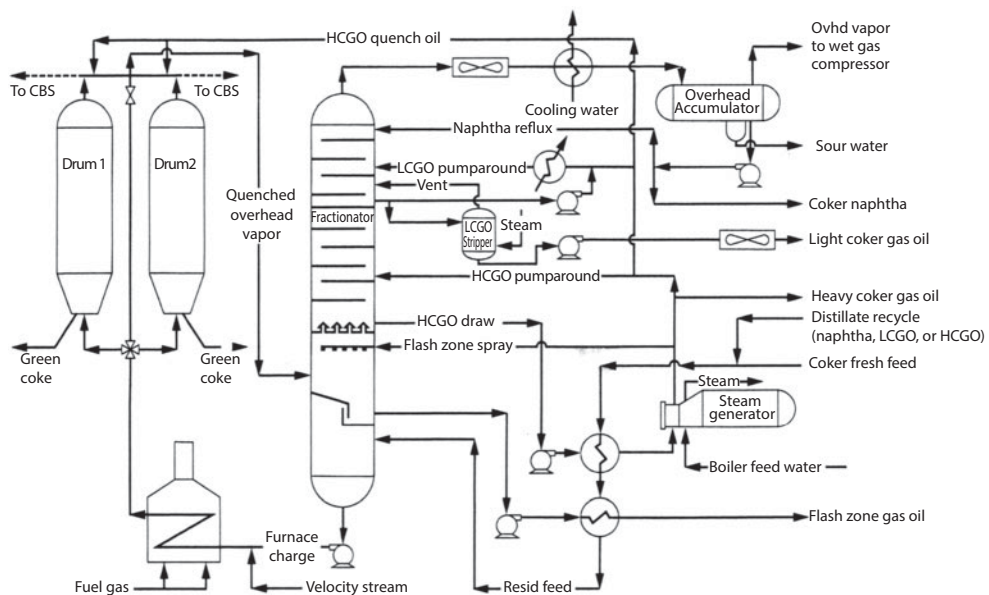


Figure 6.9 Process flow diagram of a typical delayed coking furnace/fractionation sections [7].

- Foamovers. Partially coked resid is carried over the top of the coke.
- Soft coke. The volatile combustible manner (VCM) of the coke is too high.
- Shot coke. Coke is made in small balls instead of the usual sponge structure. This coke takes its name from its buckshot appearance.
- Plugged steam-water inlet. Coke plugs the water inlet nozzle and slows down the coking cycles.
- Excessive cycle length. The capacity of a coke drum varies inversely with the cycle length.
- Warm-up condensate. This often mishandled stream can represent ½% on crude.

6.5.2 Delayed Coker Yield Prediction

Correlation based upon the weight percent of Conradson carbon residue (wt% CCR) in the vacuum residue is used to determine the product yields of delayed coking [16]. The naphtha can be split into light naphtha (LN) and heavy naphtha (HN). The split in wt% is 33.22 and 66.78, respectively, assuming corresponding gravities of 65 °API and 50 °API, respectively.

The gas oil (GO) can be split also into light coker gas oil (LCGO) and heavy coker gas oil (HCGO). The split in wt% is 64.5 and 35.5, respectively, and the corresponding gravities are 30 °API and 13 °API.

These yields data are developed from correlations and Table 6.5 is used for calculating the yields when the Conradson carbon residue (wt% CCR) in the vacuum residue is known.

The yield correlations are based on the following conditions:

1. Coke drum pressure 35–45 psig (2.4–3.1 barg).
2. Feed is straight-run residual
3. Gas oil end point 875–925 °F (468–496 °C)
4. Gasoline end point 400 °F (204 °C)

Table 6.5 Coke yields when Conradson carbon content is known.

Gas (C ₄ ⁻), wt% = 7.8 + 0.414 × (wt%CCR)
Naphtha wt% = 11.29 + 0.343 × (wt% CCR)
Coke wt% = 1.6 × (wt% CCR)
Gas oil wt% = 100 - wt% Gas - wt% Naphtha - wt% Coke
Gas oil vol% = [155.5/(131.5 + API)] (gas oil wt%)
Naphtha vol% = [186.6/(131.5 + API)] (naphtha wt%)

Typical gas compositions, sulfur and nitrogen distributions in products produced by delayed coking or reduced crudes are shown in Table 6.6 and Table 6.7, respectively.

Table 6.8 shows typical sulfur distribution in the products for delayed coking, and Table 6.9 presents typical sulfur and nitrogen distribution in the products.

Table 6.6 Coke yields, East Texas Crude Residuals.

Gas (C ₄ ⁻), wt% = 11.92 - 0.16 × °API
Naphtha wt% = 20.5 - 0.36 × °API
Coke wt% = 45.76 - 1.78 × °API
Gas oil wt% = 21.82 + 2.30 × °API
Gas oil vol% = (131.5 + °API) 155.5 (gas oil wt%)
Naphtha vol% = (131.5 + °API) 186.5 (naphtha wt%)

Table 6.7 Coke Yields, Wilmington Crude Residuals.

Gas (C ₄ ⁻), wt% = 11.27 - 0.14 × °API
Naphtha wt% = 20.5 - 0.36 × °API
Coke wt% = 39.68 - 1.60 × °API
Gas oil wt% = 28.55 + 2.10 × °API
Gas oil vol% = [155.5/(131.5 + °API)] (gas oil wt%)
Naphtha vol% = [186.6/(131.5 + °API)] (naphtha, wt%)

Table 6.8 Delayed coker sulfur distribution based on the amount of sulfur in feed.

Products	Gas	LN	HN	LCGO	HCGO	Coke
S (wt%)	30	1.7	3.3	15.4	19.6	30

Table 6.9 Delayed coker sulfur and nitrogen distribution based pm the amount in the feed.

	Sulfur, wt%	Nitrogen, wt%
Gas	30	-
Light naphtha	1.7	
Heavy naphtha	3.3	1
LCGO	15.4	2
HCGO	19.6	22
Coke	30	75
Total	100	10

6.5.3 Coke Formation

The coke formed from the condensation of polynuclear aromatics (e.g., n-butyl-naphthalene) has an H/C ratio of 0.73. The coke formed through other reactions might have the formula CH_{α} , where $\alpha = 0.2-0.8$. Coke formation can occur through the condensation of olefins and butadiene with aromatics to yield low hydrogen content coke. Thermal cracking of C_6 hydrocarbons may yield certain amount of coke ($CH_{0.8}$) as shown in Table 6.10. These reactions also yield unsaturated hydrocarbons, which might react with aromatics to yield coke precursors [17].

6.5.4 Thermodynamics of Coking of Light Hydrocarbons

Thermal cracking reactions are highly endothermic and thus require heat, which is either provided by heating furnaces or generated by burning some of the produced coke. The enthalpies and Gibbs free energies of the above reactions are listed in Table 6.11 [17]:

Table 6.11 shows that coking is increased by high temperatures. For example, reactions 3 and 5 are

thermodynamically possible when close to 1000K, while at 300–500K, they cannot proceed. An aromatic coke forms due to poly-condensation with the evolution of hydrogen. In reaction 6, the production of coke from benzene (C_6H_6) with the simultaneous separation of a light-end aliphatic hydrocarbon (C_2H_4) is thermodynamically impossible. The formation of light-end product from diene cracking (reaction 4) becomes thermodynamically probable at high temperatures, which is consistent with experimental data. The formation of coke from alkanes (C_nH_{2n+2}), alkenes (C_nH_{2n}) and cycloalkanes (C_nH_{2n}) is generally endothermic, while it is exothermic for aromatics (C_nH_{2n-6}), where $n = 1, 2, 3, 4, 5, 6$, etc.

In determining the composition of the equilibrium mixture for a coke formation reaction, the equilibrium constant K_p is expressed in terms of the partial pressures of the gaseous products. For example, reaction 5 in Table 6.11, the equilibrium constant, K_p in terms of the partial pressures and the Gibbs function is:

$$K_p = \frac{P_{C_2H_4}^{1.36} P_{H_2}^{2.97}}{P_{C_6H_{12}}} = \exp\left(\frac{-\Delta G}{RT}\right) \quad (6.1)$$

At T = 500 K

Table 6.10 Model reactions of coke formation.

Reaction no.	Reaction	Coke yield mass fraction	Type of light-end product
1	$C_6H_{14} \rightleftharpoons 1.15 C_5H_{12} + 0.34CH_{0.8}$	0.05	Alkane
2	$C_6H_{14} \rightleftharpoons 1.33C_4H_{10} + 0.68CH_{0.8} + 0.8H_2$	0.10	Alkane
3	$C_6H_{14} \rightleftharpoons 1.32C_2H_4 + 3.36CH_{0.8} + 3.01H_2$	0.50	Alkene
4	$C_6H_{14} \rightleftharpoons 0.66C_4H_6 + 3.36CH_{0.8} + 3.68H_2$	0.50	Diene
5	$C_6H_{12} \rightleftharpoons 1.36C_2H_4 + 3.28CH_{0.8} + 2.97H_2$	0.50	Alkene
6	$C_6H_6 \rightleftharpoons 1.48C_2H_4 + 3.04CH_{0.8} + 2.82H_2$	0.50	Alkene

Table 6.11 Enthalpies and Gibbs energies of reaction.

Reaction	$\Delta H(kJ)$ at T (K)			$\Delta H(kJ)$ at T (K)		
	300	500	1000	300	500	1000
1	1.8	1.4	2.0	-2.1	-4.7	-9.9
2	3.3	4.9	2.7	-8.1	-16.8	-37.7
3	266	274	276	161	90	-96
4	267	280	288	54	-29	-261
5	141.4	146	146.1	74.9	29.5	-88.5
6	21.1	20.3	12.0	36.3	47.3	78.3

$$K_p = \exp\left(\frac{-29,500}{8.31 \times 500}\right) = 8.23 \times 10^{-4}$$

At T = 1000 K

$$K_p = \exp\left(\frac{-88,500}{8.31 \times 1000}\right) = 4.2 \times 10^4$$

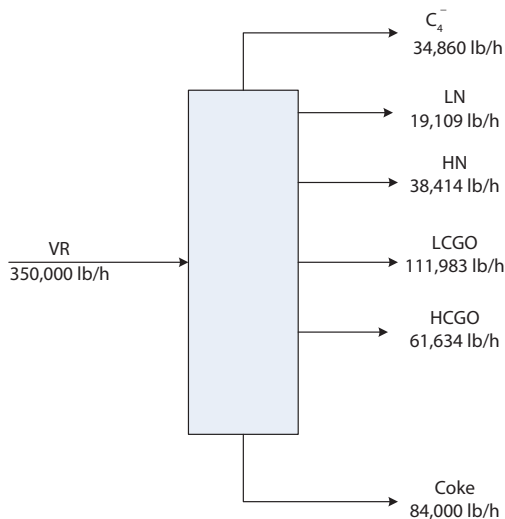
Thus while the reaction may not proceed at 500K, it proceeds favorable at 1000 K.

6.5.5 Gas Composition

The gas produced is fuel gas, which can be sent to a fuel gas network after amine washing. The gas can also be used in the alkylation unit because of its high olefin content. A typical coker gas composition is shown in Table 6.12 [10].

Example 6-1

A vacuum residue of Conradson carbon residue (wt% CCR= 15) is fed into a delayed coker at a rate of 350,000 lb/h of API = 8.5 and a sulfur content of 3.0 wt%. Determine the amount of yield (lb/h) and their sulfur content. Calculate the yields of liquid products in BDP.



Solution

The solution of the example is summarized in Table 6.13 and **Example 6-1.xlsx** shows Microsoft Excel program of Example 6.1.

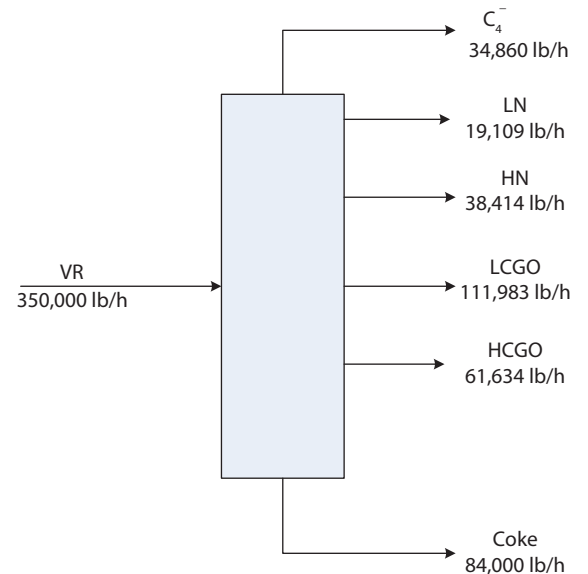
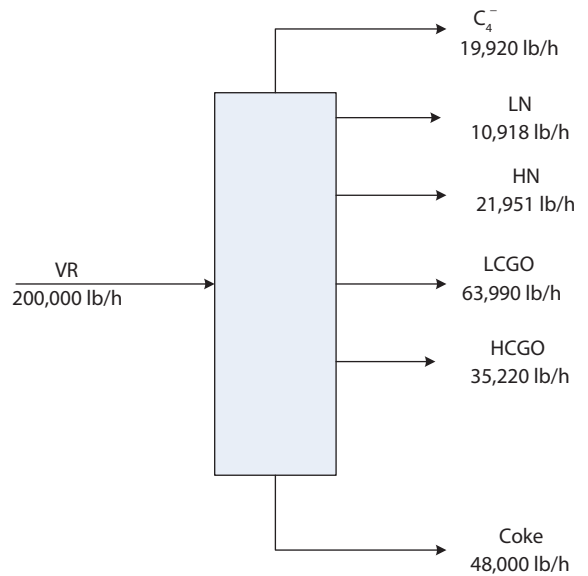


Figure 6.10 Mass balance of delayed coking.

Table 6.12 Typical gas composition from delayed coker (sulfur-free basis).

Gas	C ₁	C ₂ ⁼	C ₂	C ₃ ⁼	C ₃	C ₄ ⁼	iC ₄	C ₄	H ₂	CO ₂
Mole%	51.4	1.5	15.9	3.1	8.2	2.4	1.0	2.6	13.7	0.2

Table 6.13 Results of delayed coking example.

Feed rate = 350,000 lb/h			
Delayed coker CCR = 15 wt%			
S_r = 3 wt%			
Feed °API = 8.5			
Rate of sulfur in the feed = 10,500 lb/h			
Products yield	wt%	lb/h	
Gas (C4) wt% = 7.8 + 0.144x(wt% CCR)	9.96	348600	
Naphtha wt% = 11.29 + 0.343 x (wt% CCR)	16.435	57522.5	
Coke wt% = 1.6 x (wt% CCR)	24	84000	
Gas oil wt% = 100 - wt% coke - wt% GAS - wt% Naphtha	49.605	173617.5	
	100	350000	
Naphtha (assumed split wt%)	wt%	lb/h	
Light Naphtha LN=33.22%	33.22	19109	
Heavy Naphtha HV = 66.78%	66.78	38414	
Gas oil (assumed split wt%)			
Light Coker gas oil, LCGO	64.5	111983	
Heavy Coker gas oil, HCGO	35.5	61634	
	100	173617	
Sulfur distribution in delayed coker products (assumed wt%)			
S in gas	30.0	3150	
S in light naphtha	1.7	178.5	
S in heavy naphtha	3.30	346.5	
S in light gas oil	15.40	1617	
S in heavy gas oil	19.6	2058	
S in coke	30.00	3150	
	100.00	10500	
Gravity of products (assumed gravities)	°API	SG	BPD
Light naphtha	65	0.72	1820
Heavy naphtha	50	0.78	3376.6
Light gas oil	30	0.88	8725.5
Heavy gas oil	13	0.98	4312.6

Other Types of Coking

6.6 Fluid Coking

The vacuum residue is converted to valuable products as naphtha, diesel and coker gas oil. Fluid catalytic crackers use catalysts to aid cracking and here cracking and coking are catalyzed by coke particles. The process involves preheating the residue feed, scrubbing the coke particles and providing primary condensing of reactor vapors by introducing the feed to the scrubber. The residue is atomized into a fluid coke bed, and thermocracking occurs on the particle surface. Coke particles leaving the reactor are steam stripped to remove remaining liquid

hydrocarbons. Coke particles produced in the same unit assume more or less spherical shape and act as heat carriers while travelling from the burner (regenerator) to the reactor; and coke carriers in reverse travel. Some portion of steam stripped coke is burnt, and the remaining coke is taken out. The hot coke particles are in a state of fluidization caused by incoming vapors. Therefore, the effective continuous circulation of coke particles is unavoidable. Sub stoichiometric air is introduced to the burner to burn some of the coke and provide the necessary heat for the reactor, and the reactor vapors leave the scrubber and flow to the fractionator. Figure 6.11 shows the process sequence and Table 6.14 shows the typical yields and dispositions of delayed and fluid coking processes.

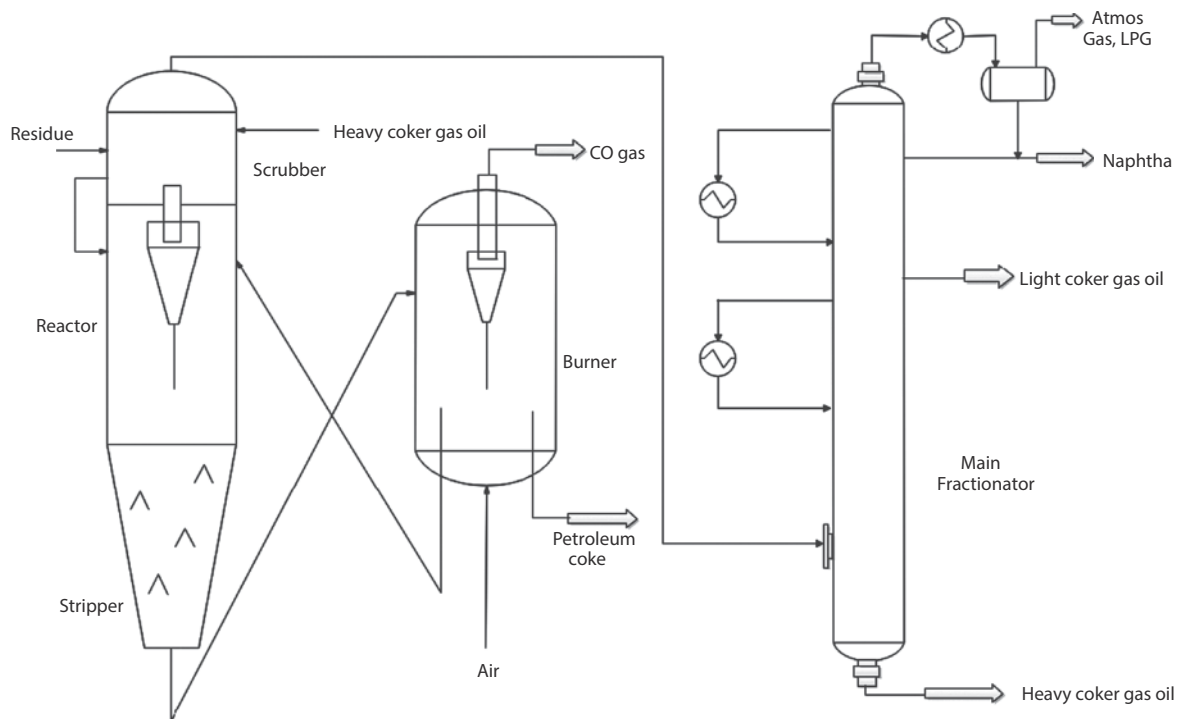


Figure 6.11 Process flow diagram of fluidic coking unit.

Table 6.14 Typical yields and dispositions of delayed and fluid coking processes.

Product	Yield, wt% of feed	Disposition
Light ends	12.5–20	LPG
Naphtha	10–15	Naphtha hydrotreating
Light Coker Gas Oil	18–24	Distillate hydrotreating
Heavy Coker Gas Oil	30–40	Fluid catalytic cracking
Petroleum Coke	20–35	Sponge-carbon anodes; Needle-graphite electrodes Any coke-power generation

6.6.1 Flexi-Coking

The feed consists of heavy residue and is fed into a scrubber fractionator reactor where thermal cracking occurs. Steam is admitted from the bottom, and the coke fines circulate through the heater where further coke formation takes place and then passes onto a gasifier where it encounters a stream of air and steam. Coke is withdrawn between the heater and the gasifier.

Flexi-coking has the same reactor/scrubber sections as fluid coking and also has the same process flexibility options: recycle and once-through. The process heat

is supplied by circulating hot coke between the heater and the reactor. Coke reacts with air and steam in the gasifier to produce heat and low Btu gas that can be used as fuel in furnaces and boilers. About 97% of the coke generated is consumed during the process as a small amount of coke is withdrawn from the heater and fine system which can be disposed in cement kilns or used in metals recovery. Partial gasification and oxygen-enrichment can be used to provide additional process flexibility. The primary advantage of the flexi-coking (Figure 6.12) over fluid coking is that most of the heating value of the coke product is made available as low-sulfur fuel gas, which can be burned without an SO_2 removal system on the resulting stack gas, whereas the system would be required if coke that contains 3–8 wt% sulfur is burned directly in a boiler. The yields for a typical Middle East vacuum residue (~25 wt% Concarbon, ~5 wt% sulfur) are:

	Recycle	Once-through
Light ends, wt%	11.8	10.4
Naphtha (C_5 , 350 °F), wt%	11.5	9.5
Distillate (350–650 °F), wt%	14.5	13.1
Heavy gas oil (650 °F), wt%	32.1	39.7
Low Btu gas, MBtu/bbl	1.2	1.1
C_{5+} Liquids, wt%	58.1	62.3

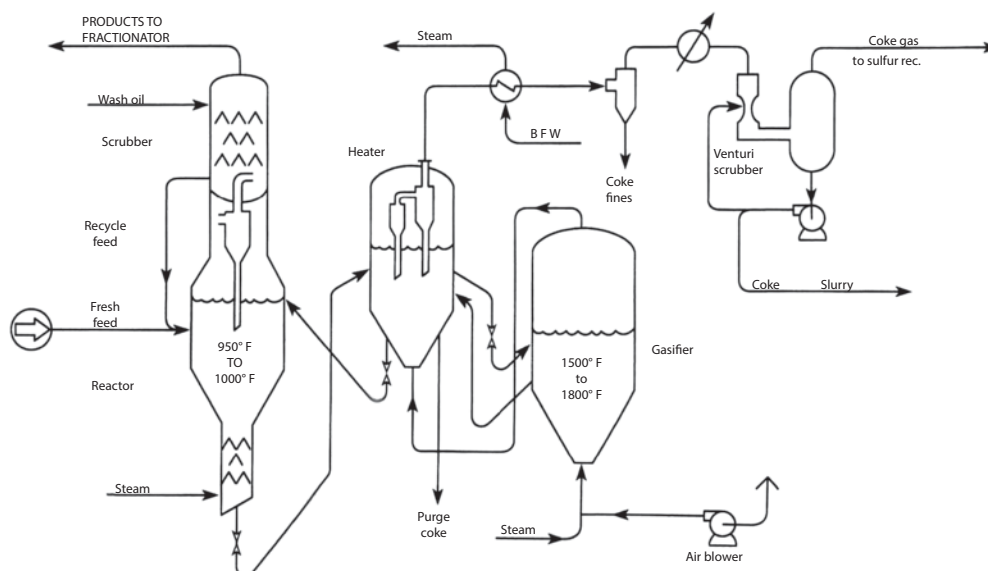
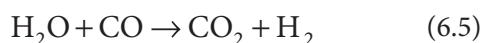
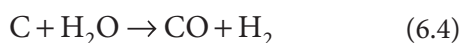


Figure 6.12 Process flow diagram of flexi-coking.

Hammond *et al.* [12] have provided a block diagram (Figure 6.12) of the process and the following reactions take place very rapidly in the oxidation zone in the gasifier:



In the reduction zone, the following reactions take place slowly:



Yield Correlations for Flexi-coking

The yield correlations for flexi-coking are based on the Conradson carbon content of the vacuum residue (CCR, wt%), its °API gravity and sulfur content (S_f). Correlations based on data compiled by Maples [11] are expressed in weight percent yields as:

$$\text{Gas wt\%} = 0.171943 \times \text{CCR wt\%} + 5.206667 \quad (6.6)$$

$$\text{Gasoline wt\%} = -0.115234 \times \text{CCR wt\%} + 18.594587 \quad (6.7)$$

$$\text{Coke wt\%} = 1.037233 \times \text{CCR wt\%} + 1.875742 \quad (6.8)$$

$$\text{Gas oil wt\%} = 100 - \text{Gas wt\%} - \text{Gasoline wt\%} - \text{Coke wt\%} \quad (6.9)$$

Gas composition:

$$C_4 \text{ wt\%} = -0.028627 \times \text{CCR wt\%} + 3.200754 \quad (6.10)$$

$$C_2 \text{ wt\%} = 0.647791 \times [\text{Gas wt\%} - C_4 \text{ wt\%}] + 0.456001 \quad (6.11)$$

$$C_3 \text{ wt\%} = \text{Gas wt\%} - C_4 \text{ wt\%} - C_2 \text{ wt\%} \quad (6.12)$$

Sulfur distribution in products:

$$S \text{ wt\% in Gasoline} = 0.193461 S_f \quad (6.13)$$

$$S \text{ wt\% in Gas oil} = 0.91482 S_f + 0.16921 \quad (6.14)$$

$$S \text{ wt\% in Coke} = 1.399667 S_f + 0.18691 \quad (6.15)$$

$$S \text{ in Gas} = S \text{ in Feed} - S \text{ in Gasoline} - S \text{ in Gas oil} - S \text{ in Coke} \quad (6.16)$$

Gravity of flexi-coker feed and gas oil

$$\text{Feed API}_f = 0.5 \times \text{CCR wt\%} + 0.932644 \quad (6.17)$$

$$\text{Gas oil API} = 1.264942 \times \text{API}_f + 0.506675 \times \text{CCR wt\%} - 0.79976 \quad (6.18)$$

Example 6-2

Use Example 6.2 for the case of flexi-coking.

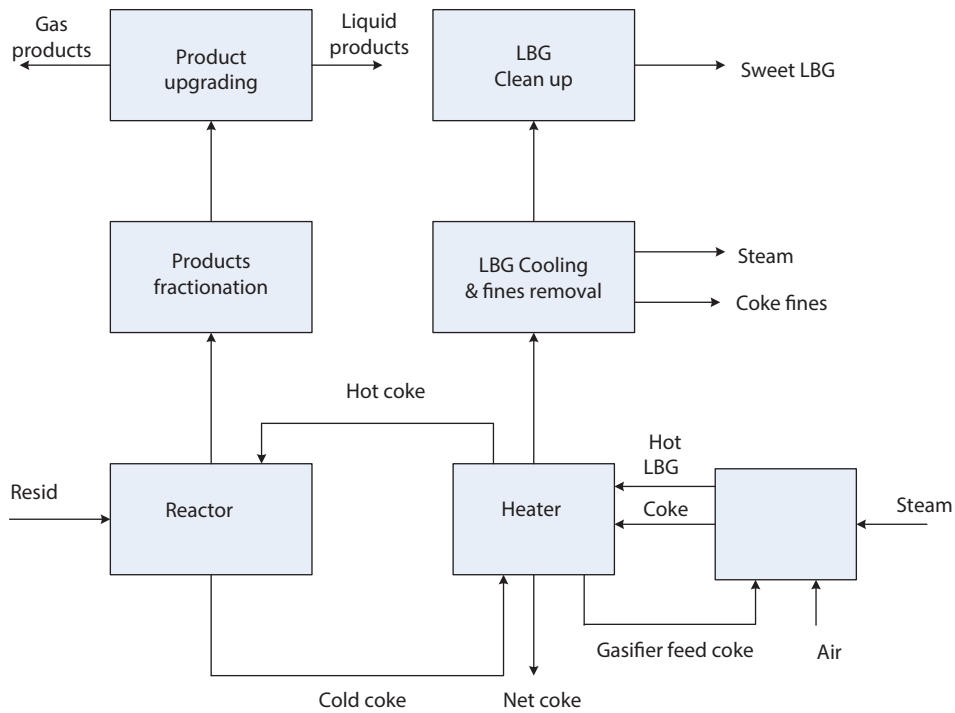
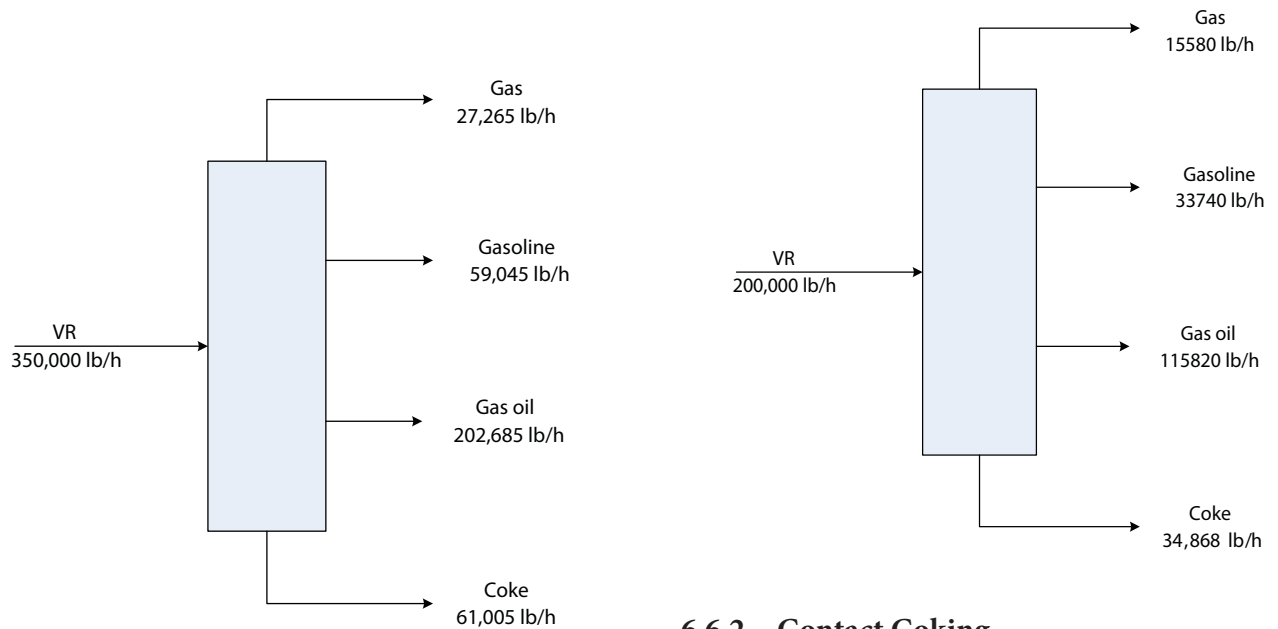


Figure 6.13 Block diagram for flexicoking.



Solution

The result of this example for flexi-coking is shown in Table 6.15 and Microsoft Excel program (**Example 6-2.xlsx**) shows calculations of Example 6.2.

6.6.2 Contact Coking

In contact coking, coke circulates between the reactor and the heater. A part of the coke is always necessary for supplying thermal energy, and the remaining portion is separated in the disengager. This method gives great flexibility in operation and control. Table 6.16 compares the methods of coking.

Table 6.15 Results of Flexi-coking example.

Feed rate = 350,000 lb/h		
Flexi-coking CCR = 15 wt%		
S_f = 3 wt%		
Feed °API = 8.5		
Rate of sulfur in the feed = 10,500 lb/h		
Products yield	wt%	lb/h
Gas wt% = (0.171943 x CCR% + 5.206667)	7.79	27265
Gasoline wt% = (-0.115234 x CCR% + 18.594587)	16.87	59045
Coke wt% = (1.037233 x CCR% + 1.875742)	17.43	61005
Gas oil wt% = 100 - Gas% - Gasoline% - Coke%	57.91	202685
	100	350000
Gases	wt%	lb/hr
C ₄ wt% = (-0.028627 x CCR% + 3.200754)	2.77	9695
C ₂ wt% = (0.647791 x (Gas% - C ₄ %) + 0.456001)	3.71	12985
C ₃ wt% = (Gas% - C ₄ % - C ₂ %)	1.31	4585
	7.79	27265
Sulfur in flexi-coker products		
S in Gasoline = (0.193461 S _f)	0.58	342
S in Gas oil = (0.91482 S _f + 0.16921)	2.91	5898.13
S in Coke = (1.399667 S _f + 0.18691)	4.39	2678.12
S Gas = (S Feed - S in Gasoline - S in Gas oil - S in Coke)		1581.75
		10500
Gravity of flexi-coker products		
	°API	SG
Gas oil API = (1.264942 x API _f + 0.506675 x CCR% - 0.79976)	17.55	0.95
Feed API = (0.5 x CCR% + 0.932644)	8.43	1.01

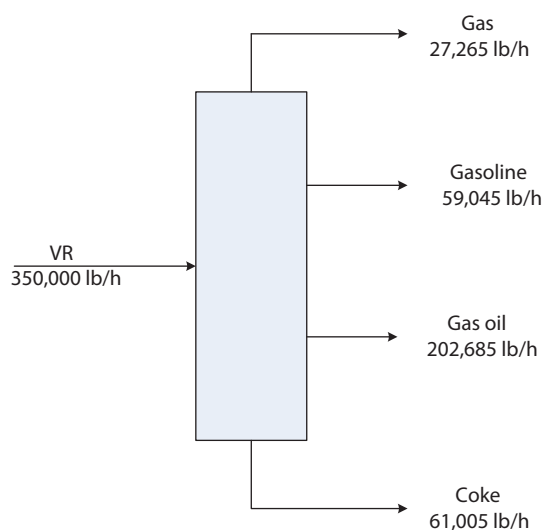


Figure 6.14 Mass balance of flexi-coking.

6.6.3 Coke Drums

Vacuum residue from VDU is preheated in preheat exchangers against heavy coker gas oil HCGO and heavy coker gas oil pumparound and passes through the fractionator boot where it is heated by mixing with the heavy fractions, and the resulting heater charge enters the coker heater coil at a high velocity. Steam is introduced into the coil which prevents coke deposition in the coil. The hot and partially vaporized mixture enters the coke drum. The coke drum is charged with the hot mixture to $\frac{1}{2}$ to $\frac{2}{3}$ of the height of the drum (see Figures 6.15 and 6.16).

The level of the hot-mix in drums is measured and controlled by a cathode-ray monitoring device. Steam and volatile matters escape from the coke drums and enter the coker fractionator. The charging of a coke drum

Table 6.16 Comparison of methods of coking [5].

	Delayed coking	Fluid coking	Flexi coking	Contact coking
Gravity °API	15	15	18.9	18.8
Conradson Carbon Residue	9	9	11.7	11.7
Sulfur	1.2	1.2	0.6	0.6
Products				
C ₃ and lighter fractions%	6	5	7.5	14.9
Coke%	22	11	13.0	20.0
CDE%	99.8	91.2	99.3	99.3

Note: CDE = Conradson Decarbonizing Efficiency.

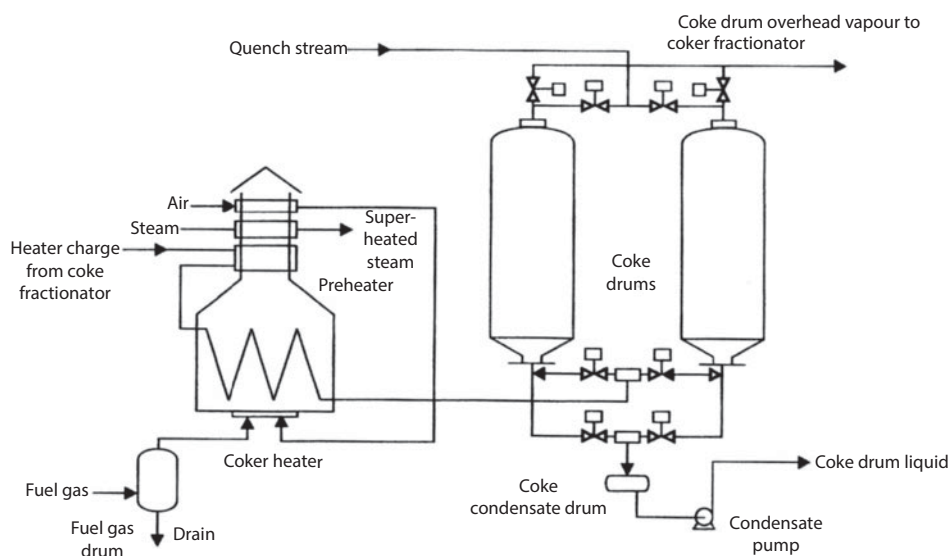


Figure 6.15 Coke drum system. (Source: Srikumar Koyikkal, *Chemical Process Technology and Simulation*, PHI Learning Private Ltd., Delhi, 2013).

may require a period of 4–5 hrs. Once the charging is complete, the drum is isolated from the stream. Effluents of the coke heater are then switched to the second drum. Coking is a slow process, and it usually takes a period of 10–16 hrs. The time of charging coke drums must balance the time of coking and decoking operations.

The feed is mixed with the stripped liquid (internal recycle) at the bottom of the coker fractionator. This recycled stream is heavier than the heavy coker gas oil and condenses in the wash section of the column. The mixture is referred to as the heater charge. The introduction of relatively cool coker feed into the fractionator bottom reduces the tendency of coke formation in the column bottoms. Fractionator bottoms liquid level is maintained by regulating the flow rate of coker feed from the coker feed drum. A side stream of fractionator bottom liquid is continuously circulated through the fractionator bottoms strainers by the fractionator bottoms recirculating pump to remove the coke fines.

The coker heater charge is pumped by the coking heater charge pump, as the primary function of the coker heater is rapidly to heat the feed to the required reaction temperature while avoiding premature coke formation in the heater tubes. The steam coil above the process convection section in the coker heater superheats the medium pressure steam. This steam is used for stripping light coker gas oil (LCGO) and heavy coker gas oil (HCGO). The coker heater combustion air is also preheated against flue gas in the convection section to increase efficiency. The coker heater is fired with fuel oil or fuel gas or combination of both fuels. A heater fuel gas drum separates any condensable liquids in the fuel gas before they reach the coker heater.

A two-heater configuration would allow offline decoking of one furnace without having to shut down the entire unit. The coke drum feed leaves the heater at ~ 1040 °F (506 °C) and 4.0 kg/cm². The coke drum inlet switch valve diverts the hot coker feed to the bottom of

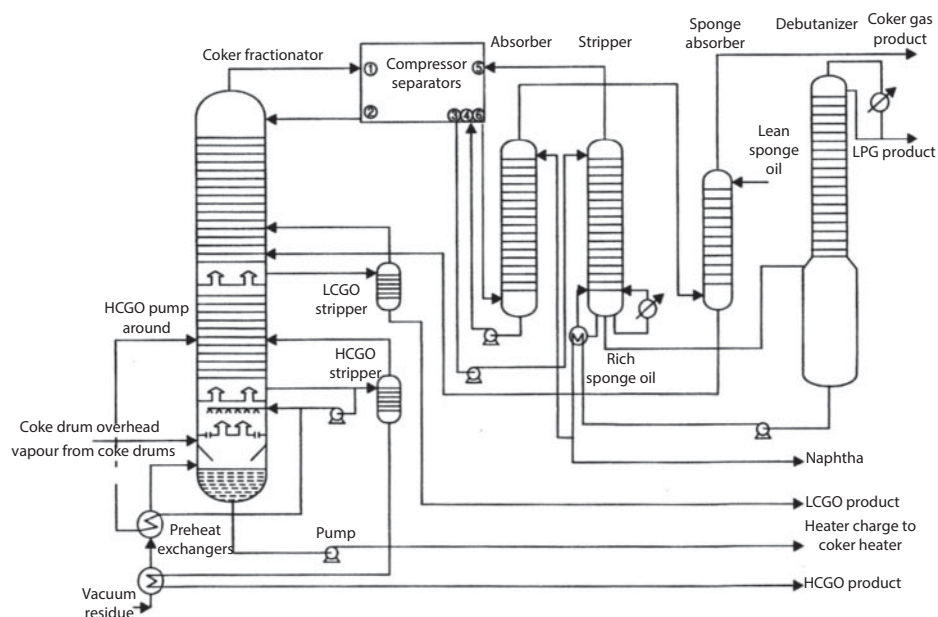


Figure 6.16 Typical coker fractionator system (Source: Sri Kumar Koyikkal, *Chemical Process Technology and Simulation*, PHI Learning Private Ltd., Delhi, 2013).

the filling or coking mode coke drum. In the coke drum, the hot feed cracks to form coke and cracked products. Each coke drum is filled in a 24-hour period. An anti-foam chemical is injected into the coke drum to prevent foam going into the coker fractionator. The cracked product leaves the top of the coke drum at 842 °F (450 °C) and 1.05 kg/cm², which is quenched to 799 °F (426 °C) or less with heavy coker gas oil to stop the cracking and polymerization reactions, and thus to prevent coke formation in the vapor line to the coker fractionator.

Figure 6.16 shows the fractionator column of 24 trays and a spray zone divided into two major sections by the heavy coker gas oil (HCGO) draw pan. The quenched coke drum effluent vapor flows upwards through the spray chamber, with some degree of cooling accomplished by contact with HCGO wash liquid. The heavy recycled liquid is condensed and collected on the wash section chimney and flows to the bottom sump to combine with fresh coker feed. The product vapor flows to the upper section of the column through the vapor risers in the heavy coker gas oil draw-off pan. This vapor consists of the products and steam. Heat removal and fractionation are accomplished in the upper section of the fractionator.

6.6.4 Heavy Coker Gas Oil (HCGO) Production

HCGO draws are taken from the same draw tray and used for quenching, pumparound and HCGO stripper

feed. The HCGO quench, HCGO wash and HCGO pumparound are pumped by common pumps. The heat in the pumparound is also used to produce steam.

The HCGO product draw from the coker fractionator flows under level control by gravity to the stripper. It is steam-stripped in the stripper, and vapors are returned to the fractionator. The stripped HCGO product is pumped by the HCGO product pumps to heat the fresh feed, which is then utilized in generating steam in the medium pressure (MP) steam generator. Finally, the HCGO product stream is cooled to 176 °F (80 °C) in the HCGO product air cooler and is routed as cold HCGO product to the refinery fuels blending section.

6.6.5 Light Coker Gas Oil (LCGO) Production

LCGO is withdrawn from the chimney tray below tray 15 of the coker fractionator, and flows by gravity under level control to the light coker gas oil stripper. Medium pressure superheated steam is used for stripping LCGO product, which is then successively cooled to 104 °F (40 °C) and flows to the coalescers and salt driers and finally to storage and blending.

6.7 Fractionator Overhead System

The fractionator overhead system separates the combined vapor and liquid overhead products from the

coker fractionator into sweet coker gas, LPG and coker naphtha. It mainly consists of wet gas compression, an absorber, a stripper, a sponge absorber and a debutanizer.

Condensation: The overhead vapor from the coker fractionator is cooled by air cooler and condensed in the coker fractionator overhead condensers, and coker fractionator overhead trim condensers. It then enters the coker fractionator overhead receiver where vapor, hydrocarbon liquid, and condensed water are separated. The vapor from the overhead receiver is routed to the vapor recovery section.

The fractionator reflux pumps are used to pump a portion of the hydrocarbon liquid back to the fractionator top tray as reflux under flow control reset by the column overhead temperature. This indirectly controls the naphtha end point temperature. The fractionator overhead liquid pump is used to pump the net naphtha stream to the vapor recovery section. The sour water pumps are used to pump the condensed water under level control to the storage tanks. A portion of the sour water is recycled under flow control to the inlet of the compressed interstage cooler.

Wet gas compression: Figure 6.17 shows the schematic of the wet gas compressor. It is a two-stage high pressure steam turbine driven compressor (100% condensing type), that compresses wet gases from the coker fractionator receiver. The first section discharges vapor at 3.6 kg/cm^2 ; the vapor is then cooled to 40°C in the compressor interstage cooler where vapor, hydrocarbon liquid and water are separated. The condensed sour water recycles under its own pressure back to the inlet of the coker fractionator condenser as wash water. The compressor interstage liquid pump, pumps the hydrocarbon liquid to the inlet of the compressor

discharge cooler, where it connects with the second section discharge stream from the wet gas compressor. The second stage of the wet gas compressor, compresses the vapor from the compressor interstage drum to 14.9 kg/cm^2 where the vapor combines with the interstage drum hydrocarbon liquid. The recycled sour water is from the coker fractionator receiver, the stripper overhead vapor from the stripper and the absorber bottoms liquid from the absorber. The combined stream is cooled and condensed in the compressor discharge cooler and then enters the recontact drum.

Absorber: The vapor from the recontact drum enters the bottom of the absorber. The absorber has ~ 30 trays. The cooled naphtha (lean oil) from the debutanizer bottoms is fed to the top of the absorber to reduce the loss of liquefied petroleum gas (LPG) in the coker gas stream. The absorber overhead vapor is routed to the downstream sponge absorber. The absorber bottoms return the rich lean oil from the absorber bottom to the recontact drum via the compressor interstage cooler under a level control. The liquid from tray 15 of the absorber is pumped through the intercooler into the absorber water separator. The hydrocarbon liquid flows from the top of the separator back to the column and enters on tray 17. The water from the bottom of the separator flows back to the coker fractionator overhead receiver.

Stripper:

The liquid from the recontact drum flows to the stripper; the stripper column strips ethane (C_2H_6) and lighter components from the LPG and naphtha. The stripper has two reboilers and liquid from the bottom sump of the column flows to the shell side of

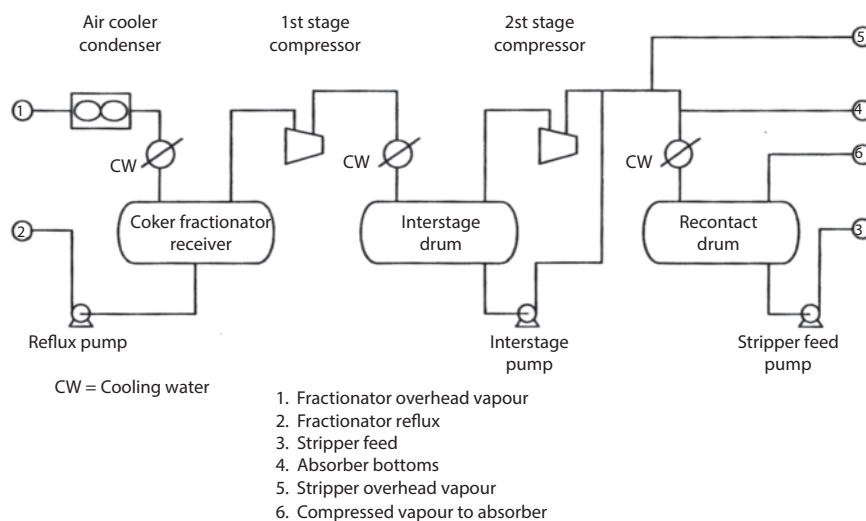


Figure 6.17 Wet gas compressor separators.

the stripper lower reboiler by thermosyphon action. The heating medium is the hot debutanizer bottoms stream, and medium pressure (MP) steam flows to the upper reboiler. The vapor from the top stripper column flows to the recontact drum via the compressor inter-stage cooler. The stripper bottoms liquid flows by its own pressure to the debutanizer. A water trapout drum is provided towards the top portion of the stripper column to remove any free water.

Sponge absorber: The absorber overhead vapor flows to the bottom of the sponge absorber, which has ~ 21 trays. The cooled lean sponge oil (Light Coker Gas Oil) from the light Coker gas oil stripper is fed to the top of the sponge absorber to reduce the loss of naphtha in the absorber overhead vapor stream. The sponge absorber overhead vapor is sour gas that is routed to the refinery fuel system. The rich sponge oil from the sponge absorber bottoms is used to cool the lean sponge oil before it is returned to the coker fractionator.

Debutanizer: The debutanizer column has ~40 trays. The unstabilized naphtha is separated into an overhead product of coker LPG and a bottom product of stabilized naphtha. The overhead vapor is totally condensed in the debutanizer overhead condensers and is then routed to the debutanizer overhead receiver. The liquid from the accumulator/receiver is returned to the top of column via the reflux pump. Some of the liquid is withdrawn from the receiver as coker LPG product by a level control and is routed to the LPG storage tank. The pressure is controlled in the receiver by throttling the overhead condenser's hot vapor bypass control valve.

The debutanizer bottoms stream flows to the stripper reboiler where it is cooled to 40 °C by the air cooler followed by the debutanizer bottoms trim cooler. The product as naphtha is pumped to a storage vessel.

6.8 Coke Drum Operations

Coking is a semi-batch operation with each drum running on-line for 24 hrs that includes filling and off-line for 24 hrs of decoking. The total cycle for each drum is 48 hrs. Table 6.17 shows the time taken for different operations.

Switch-over of drums: After completing the coke drum filling cycle, the coker heater effluent is diverted to the other (empty) coke drum by means of the switch valve. Steam is then injected into the bottom of the coke-filled drum for ~ 30 minutes with volatile light hydrocarbons purged to the coker fractionator. The steam rate is increased for 60 minutes, and the resultant

vapors (mostly steam) are routed to the bottom of the blowdown tower.

Steamout and blowdown of drums: The blowdown tower cools and condenses the steam such that hydrocarbon vapors evolved from the coke drum during the steaming, water cooling and drum reheating operations. There are 12 special tray types for contacting the vapors from the coke drum with a stream of recirculating quench oil to condense the high-boiling point hydrocarbons. The quench oil circulation rate is adjusted to maintaining ~ 180 °C as the blowdown tower overhead vapor temperature to prevent water condensation in the tower.

Figure 6.18 shows a simplified closed blowdown system. The principal functions are to maximize hydrocarbon and water recovery, to provide cooling for the coke drums and to minimize air pollution during normal operations. During the first step of the coke drum cooling process, steam is injected into the coke drum to strip residual hydrocarbon vapors from the full coke bed and into the coker fractionation tower. After a specific duration of time, the steam and hydrocarbon vapors from the coke drum flow to the quench tower in the blowdown system. The blowdown quench tower also receives hydrocarbon vapor from the coke drums during the back warming stage of the normal drum cycle and in emergency relief scenarios.

Effect of API gravity on delayed coker yields: Table 6.18 shows the effect of gravity measured in °API on delayed coker yields.

Table 6.17 Time for coke drum operations.

Operation	Hours
Coking	24.0
Switch drums	0.5
Steam out to Coker fractionator	0.5
Steam out to Blow down System	1.0
Slow water cooling	1.0
Fast water cooling	4.0
Drain coke drum	3.0
Remove Top and Bottom Heads	1.0
Hydraulic Coke Boring/Cutting	4.0
Reheating/Pressure Testing	2.0
Drum heat-up	5.0
Idle	2.0
Total	48.0

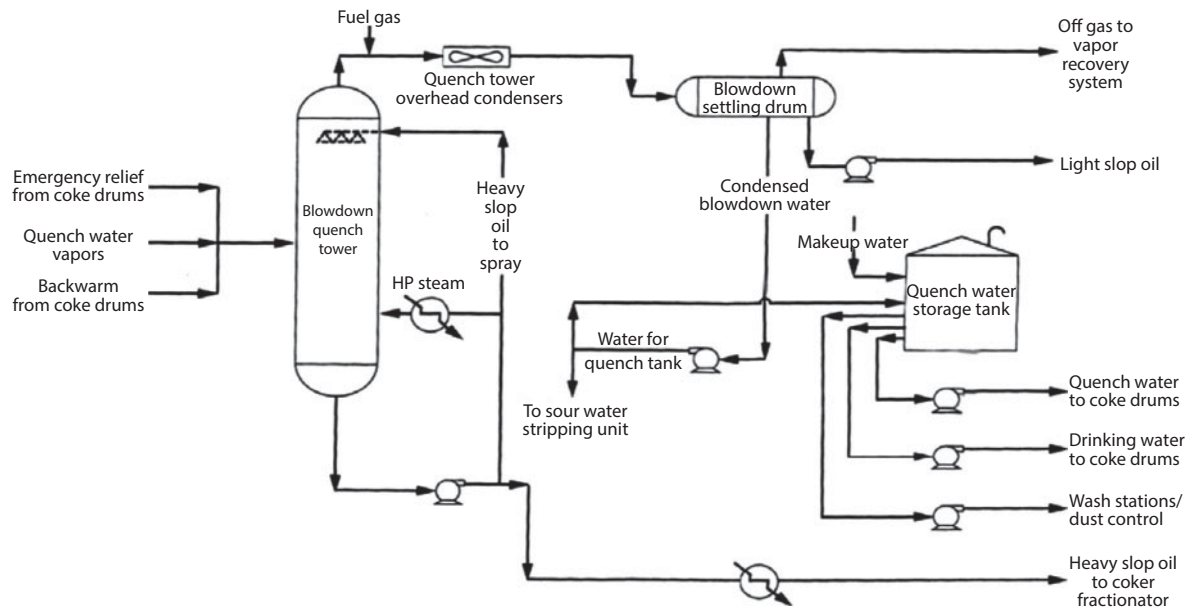


Figure 6.18 A simplified closed blowdown system process flow diagram [7].

Table 6.18 Effect on API gravity on delayed coker yields.

Product yield in wt%							
Charge API	Carbon residue (%)	Drum outlet temp. (°C)	Gas (vol%)	Coke	Gasoline	Gas oil	Heavy gas oil
12.3	16	435	4.2	16.6	8.9	19.0	53.3
13.0	16	435	4.0	15.5	8.8	17.3	54.4
14.0	16	435	3.6	13.6	8.6	19.1	55.1

Table 6.19 Effect of recycle ratio on product yields.

Product yield in wt%					
Recycle ratio in (vol%)	Coke	Gas	Gasoline	Gas oil	Heavy gas oil
0	15.5	4.0	13.0	21.5	46.0
20	18.0	5.5	15.0	26.0	36.0
40	20.0	6.0	15.5	28.5	24.5

Effect of recycle ratio: Table 6.19 shows the effect of recycle ratio on product yields.

6.9 Hydraulic Jet Decoking

Coke becomes very hard and difficult to remove once it is set. Decoking is often a time-consuming and arduous task. In early delayed-coking units, cable decoking was used to remove the coke from the drums. Later, a more sophisticated method was developed. This method, which used a hydraulically operated mechanical drill

to remove the coke from the drums, was introduced in the late 1930s is still being used today.

Hydraulic decoking utilizes high-impact water jets, which operate at ~ 2000 - 4000 lb./in² (~136–272 atm) and are the standard method of removing coke formed in the coke drums. This method has replaced older methods such as coiled wires and mechanical drills as these were unsuitable for larger drums and were costly in terms of maintenance.

In hydraulic decoking, the coke is cut as the water-jet impacts on the coke. Both boring and cutting tools are used as each tool produces several jets of water from

high-pressure nozzles. After coking is complete, steam is introduced to drive off the hydrocarbon vapors. The top flange is then disconnected, and the chains are pulled by cranes. This upward thrust shatters the coke into pieces, which makes it easy to remove.

6.10 Uses of Petroleum Coke

Depending on the fundamental type produced and the specific impurity levels present in the final product, petroleum coke is used for four types of applications: as fuel, electrode, metallurgical and gasification.

Fuel: The use of petroleum coke as a fuel generally falls into two major categories, fuel for steam generation and fuel for cement plants. For each of these applications, coke is generally blended with bituminous coal or used in combination with oil or gas. In general, coke as a fuel used in combination with bituminous coal has the following advantages over bituminous coal alone:

- **Grinding:** Coke is easier to grind than bituminous coal, resulting in lower grinding costs and less maintenance.
- **Heating value:** The heating value of petroleum coke is more than 14,000 Btu/lb compared with 9000–12,500 Btu/lb of coal.
- **Ash content:** The very low ash content (< 0.5 wt%) of coke results in lower ash-handling costs.

Steam Generation. Steam generation by coke burning can be accomplished either in specially design utility boilers or in fluidized-bed boilers.

Cement Plants: Coke can be used with coal, natural gas, refinery fuel gas or oil as a supplementary fuel in fired kilns. Coke by itself does not contain enough volatile material to produce a self-sustaining flame, and as such cannot be fired alone in cement kilns. Typical fuel combinations for cement plants are 25% oil or gas and 75% coke or 70% bituminous coal and 30% coke.

Use for Electrodes

Low-sulfur, low-metals sponge coke, after calcination can be used to manufacture anodes for the aluminum industry. The industry is the greatest single consumer of coke. For every pound of aluminum produced by smelting, nearly ½ lb of calcined coke is consumed.

Needle coke is a highly ordered petroleum coke produced from special low-sulfur aromatic feedstocks. The

main use of calcined needle coke is in the manufacture of graphite electrodes for electric-arc furnaces in the steel industry. These electrodes are subject to extremes in temperature shock and therefore, a low coefficient of thermal expansion is very important.

Metallurgical Use

Petroleum coke with low sulfur content (2.5 wt% or less) can be used in ferrous metallurgy when blended with low-volatility coking coals. Petroleum coke used in foundries or for steel making increases the properties of coking coals by reducing the total amount of volatiles and increasing the average heating value.

6.11 Use of Gasification

The gasification process involves the complete cracking of residue into gaseous products. Delayed coke is employed as feed for gasification to produce a low Btu gas or syngas, which is accomplished through the use of partial-oxidation techniques. Low-Btu gas can be used as fuel gas in the refinery; syngas can be used for the production of methanol for automotive fuel blending or as a feedstock for other chemical processes. Partial oxidation can also be used to produce the increased hydrogen necessary to refine heavy or higher-sulfur crudes into commercial products. The amount of low-Btu gas that can be handled in existing refineries is often restricted by their equipment. However, in new grass-root refineries, a large part of fuel needs can be satisfied by gasification.

Gasification involving partial oxidation in which carbonaceous solids react with oxygen, enriched air or air according to the overall reaction:

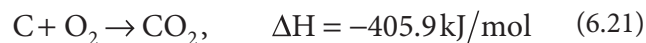


The following reactions are involved:

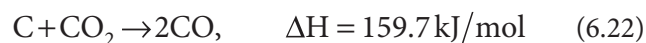
Gasification with O_2 :



Combustion with O_2 :

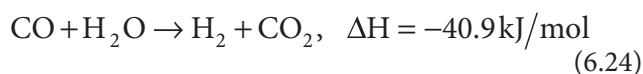


Gasification with CO_2 :



Gasification with steam:

Most of the O_2 fed to the gasifier is consumed in reactions (6.20) and (6.21). These reactions generate heat to increase the temperatures at which chemical bonds are broken, and gasification reactions (6.22) and (6.23) then become favorable. If the gas is considered for a subsequent synthesis, the water-gas shift reaction is involved:

**6.12 Sponge Coke**

Sponge coke is the most common type of regular-grade petroleum coke, while needle coke can be made only from special feedstocks. The name sponge coke is used because the lumps of coke that are produced are porous and at times resemble a sponge-like material. Typical sponge-coke specifications both before and after calcination are given in Table 6.20.

6.13 Safety and Environmental Considerations

Safety is an essential core value for which companies now dedicate significant time and resources toward continuous improvement. Over the last decades, the

number of major coker incidents has significantly increased, in spite of the heightened awareness emerging from new regulations such as OSHA 29CFR 1910. The companies involved in major incidents often had excellent process hazard analysis systems and emergency response measures; however, they are still not immune to the potential hazards. Therefore, further detailed analysis is necessary to determine how to best provide additional protection for people and property in and around the coker unit. Compiling industry data showed that regardless of the root cause, all major coker incidents manifest in three key areas: at the coke drum top head, bottom head or drain lines. Workers risk exposure to fires, smoke inhalation, thermal burns; coke drum blowouts, and coke bed cave-ins at these locations. Therefore, it is necessary to develop a methodology to evaluate each work location on the coker structure to the key hazard areas. The principal objectives are to take steps in mitigating the hazard and improving egress routes. A gap is often identified within most safety systems between the loss-of-containment event and the time when the emergency response team arrives. Therefore, it is important to identify the worker's route of natural egress, or where the worker initially runs after an incident and provides the means for that worker to get from the egress point to a safe location. Inherently safe operations can be applied as [7]: the general coke drum structure design provides unhindered open paths through the length of the switch and unheading decks, and places them on a common elevation. This approach helps provide more accessible evacuation routes and better communication

Table 6.20 Typical Sponge-Coke Specifications [6].

Item	Green coke	Calcined coke
Moisture	6–14%	0.1%
Volatile matter	8–14%	0.5%
Fixed carbon	86–92%	99.5%
Sulfur	1.0–6.0%	1.0–6.0%
Silicon	0.02%	0.02%
Iron	0.013%	0.02%
Nickel	0.02%	0.03%
Ash	0.25%	0.4%
Vanadium	0.015%	0.03%
Bulk density	45–50 lb/ft ³ (720–800 kg/m ³)	42–45 lb/ft ³ (670–720 kg/m ³)
Real density		2.06 g/cm ³
Grindability (Hardgrove number)		50–100

during the switching process. The overhead vapor line eductor design helps protect operators from potentially harmful vapors that can escape at the top head. The fixed sloped-wall and pit design offer greater barrier protection to drain fires and have excellent energy dissipation for bottom blowout events. It is necessary to ensure that procedures for switching, steaming, cooling and draining significantly reduce hot spots in the coke bed, which in turn ensures a safer and cleaner drilling process.

Layer of Protection Analysis (LOPA) methodology can be incorporated in the hazard analysis and safety reviews on the coker and other refining units. The LOPA evaluation provides an order-of-magnitude approximation of the risk to identify whether additional safeguards are required. The LOPA evaluation process can be employed in evaluating coker unit safety interlock systems and develop a thorough safety interlock system logic matrices.

The latest environmental development for the refinery industry is the signing of Consent Decree with the U.S. Environmental Protection Agency, the U.S. Department of Justice and individual state governments. Refiners agree to implement pollution-control technologies and equipment to reduce significantly, SO_2 and NO_x emissions from refinery process units and enhance sitewide monitoring, and fugitive emission controlled programs. A licensor can commit itself to conduct an extensive coker flare gas minimization study to evaluate operational best practices and design procedures for flares servicing delayed cokers. This study could find ways of optimizing flare gas recovery operation and to create a flareless operation delayed coking design.

Although cokers normally use little of a refinery's cooling water capacity, the decoking and coke handling processes do require large quantities of water. Coking and calcining facilities can create a dusty atmosphere. Fine-tuning coke handling and dewatering operations to use the optimum water quantities are necessary in reducing water and air pollution. Too much water creates excess runoff, while too little creates additional coke dust in the air [7].

6.14 Simulation/Calculations

Simulation of coking fractionators is more complex than other simulations. While the simulation is carried out, the number of theoretical trays may be fed as compared to the actual number of trays. A percentage

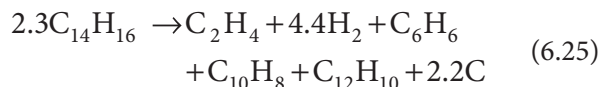
of the actual number of trays for easy convergence is used, and this can be adjusted to real trays during the simulation exercise. This is because the number of real trays does not really affect the material and energy balance if the pressure drop across the tower is selected correctly. The number of theoretical trays affects the simulation. The coker fractionator simulation is carried out as follows [5]:

1. Create a unit set using FPS or MKS units along with common refining industry specific units.
2. Choose a property package, e.g., PENG ROBINSON
3. Select and add water, carbon dioxide, hydrogen, methane, ethane, propane, two butanes and two pentanes, hydrogen sulfide, and any other components present which can be considered as free components.
4. Create hypothetical components (also referred to as pseudo-components).
5. Start with the hot overhead vapors from the coke drum as a feed to the Coker fractionator. The wash section of the column should be treated as a separate scrubber through which the vapors pass and enter the fractionator. Model the fractionator as a refluxed absorber equipped with side stream operations. Fix the number of trays for the main column and the strippers. Configure each of the strippers as yielding a product. Converge on it giving random results, add the side strippers and converge on it again. With these results and assumed values, converge on the overhead system and add it to the fractionator system. With the assumed values, converge on the stripper, the two absorbers and debutanizer one by one. Finally, join the whole system together to give the required results.
6. Make a list of products and results you expect from your simulation. Run the simulation and ensure that you can match your expected results.
7. Check quality and quantity of products obtained, and change the design parameters as required to obtain the required quality and quantity.

A Case Study: Process Simulation of Delayed Coking

The composition of vacuum residue is complex and the thermal decomposition reactions are difficult to

simulate in a single model. Here, the following model reaction to describe the thermal cracking of vacuum residue is [16]:



Vacuum residue at a rate of 9000 kg/h is fed into a delayed coker. The composition of the feed used is shown in Table 6.21. Apply a process simulator to simulate the delayed coker process using reaction Eq. (6.25) in the reaction block.

Solution

Figure 6.19 shows the snapshot of simulation flow diagram, Figures 6.20 and 6.21 are snapshots of column Connections and Monitor of the Design Window. Figures 6.22 and 6.23 show the temperature and pressure profiles of the column. The results of the simulation of delayed coking (**Delayed Coking.usc**) can be

accessed via the Scrivener publishing companion website of this text.

Summary of the results are provided in Tables 6.22 and 6.23.

Table 6.24 illustrates troubleshooting checklist for delayed coker cycle problems.

6.15 Visbreaking

This is a well-established non-catalytic thermal process that converts atmospheric or vacuum residue to gas, naphtha, distillates and tar. Visbreaking reduces the quantity of cutter stock required to meet fuel oil specifications while reducing the overall quantity of fuel oil produced. The conversion of these residues is accomplished by heating the residue material to high temperature in a furnace. The material is then passed through a soaking zone, located either in the heater or in an external drum under adequate temperature and pressure constraints so as to produce the desired products. The heater effluent is then quenched with a quenching medium to stop the reaction.

Table 6.21 Component presentation of each stream.

Component	Formula	Petroleum cut representing	Composition (mole fraction) in feed
n-Butyl –naphthalene	$C_{14}H_{16}$	Vacuum residue	1.0
Ethylene	C_2H_4	Gas	0
Hydrogen	H_2	Gas	0
Benzene	C_6H_6	Naphtha	0
Naphthalene	$C_{10}H_8$	LCGO	0
Di-phenyl	$C_{12}H_{10}$	HCGO	0
Carbon	C	Coke	0

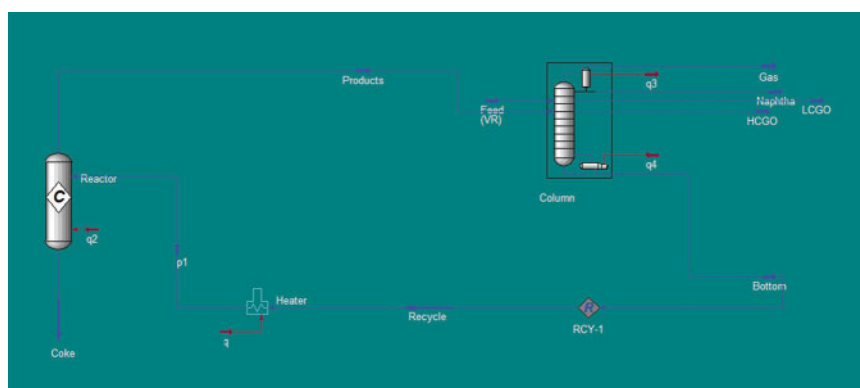


Figure 6.19 Snapshot of simulation flow diagram (Courtesy of UniSim Design R443, Honeywell Process Solutions, Honeywell (R) and UniSim (R) are trademarks of Honeywell International Inc.).

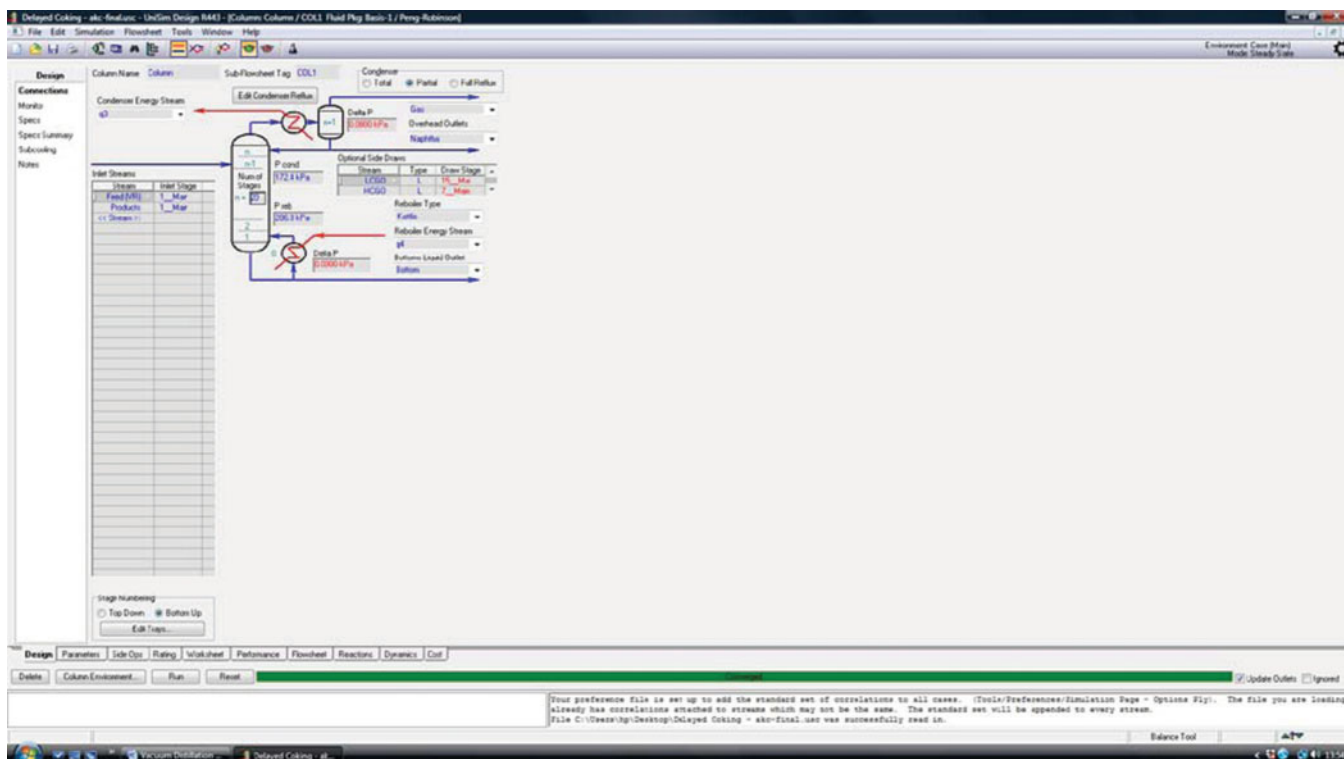


Figure 6.20 Snapshot of the Connections of the Design column Window (Courtesy of UniSim Design R443, Honeywell Process Solutions, Honeywell (R) and UniSim (R) are registered trademarks of Honeywell International Inc.).

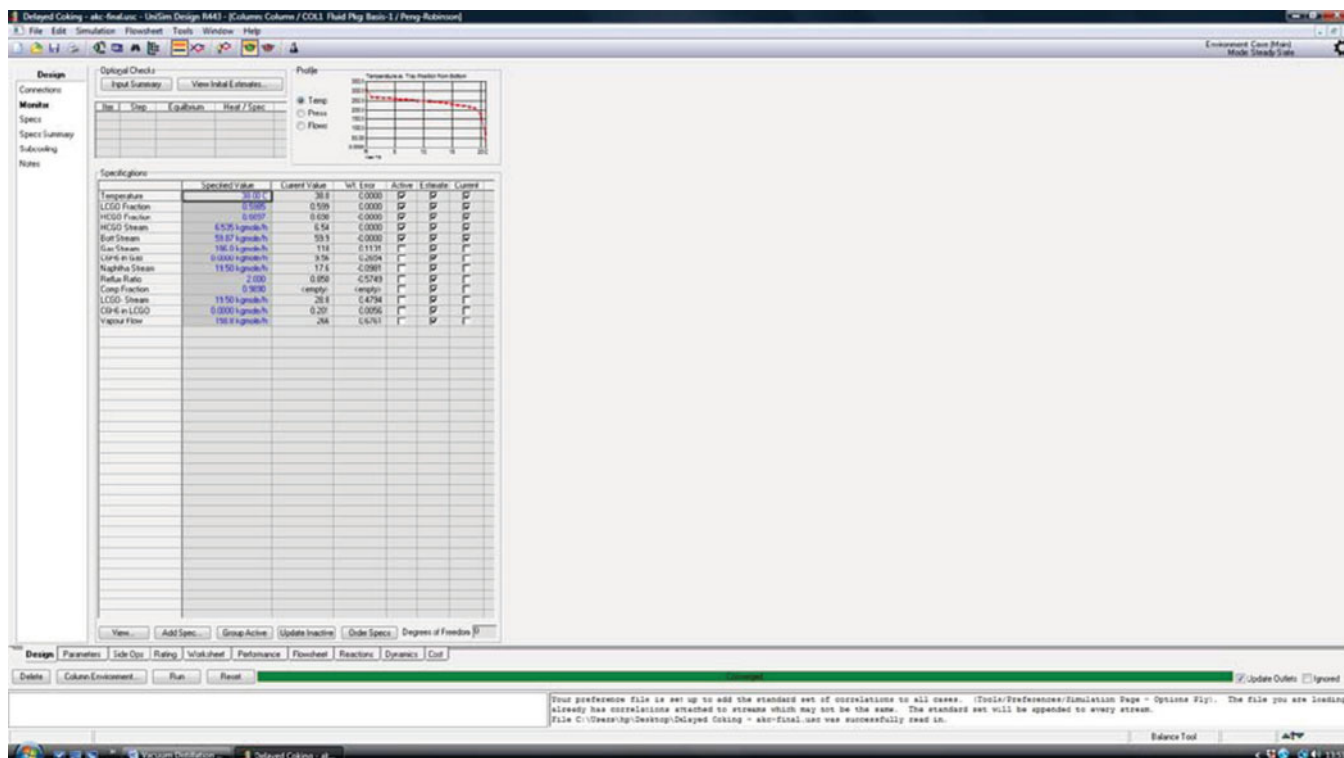


Figure 6.21 A snapshot of the Monitor of the Design column Window (Courtesy of UniSim Design R443, Honeywell Process Solutions, Honeywell (R) and UniSim (R) are registered trademarks of Honeywell International Inc.).

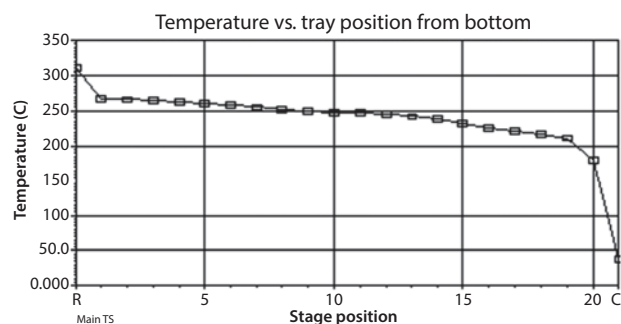


Figure 6.22 Temperature vs. stage position profile of the column (Courtesy: Honeywell Process Solution, UniSim Design R433).

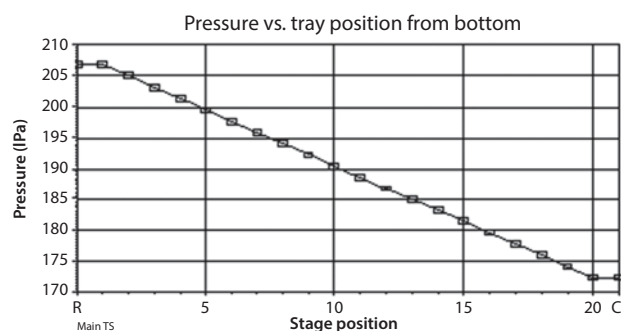


Figure 6.23 Pressure vs. Tray position profile of the column (Courtesy: Honeywell Process Solution, UniSim Design R433).

The processing of heavier crudes with a greater demand for distillate products offers visbreaking a low-cost conversion capability to produce gas and distillate products while simultaneously reducing fuel oil viscosity. In some refineries, the visbreaking unit processes the short residue from the HVU alternatively, long residue direct from the CDU. The resulting products are naphtha and gas oil and visbroken residue goes for blending either with kerosene or gas oil to be used as fuel oil. In upgrading residual streams, visbreaking unit is often considered as the following objectives are typically identified:

- Conversion of a portion of the residual feed to distillate products, especially cracking feedstocks. This is achieved by operating a vacuum flasher downstream of a visbreaker to produce a vacuum gas oil cut.
- Viscosity reduction of residual streams which will reduce the quantity of high-quality distillates necessary to produce fuel oil meeting commercial viscosity specifications. Reduction of fuel oil production while at the same time reducing pour point and viscosity. This is achieved by utilizing a thermal cracking heater, in addition to a visbreaker heater, which destroys the high wax content of the feedstock.

Table 6.22 Material balance sheet of simulation results.

	Feed (VR)	Gas	Naphtha	LCGO	HCGO	Coke
Vapor fraction	0	1.0	0	0	0	0
Temp. (°C)	176	38.0	38.8	232.6	255.4	310.4
Press. (kPa)	294	172.4	172.4	181.5	195.9	206.8
Mass flow (kg/h)	9000	1490	1736	4122	1059	593

Table 6.23 Stream composition (mole fraction).

	Feed (VR)	Gas	Naphtha	LCGO	HCGO	Coke
$C_{14}H_{16}$	1.00	0	0	0.008	0.367	0
C_2H_4	0	0.170	0.001	0	0	0
H_2	0	0.749	0	0	0	0
C_6H_6	0	0.081	0.462	0.007	0.006	0
$C_{10}H_8$	0	0	0.530	0.419	0.101	0
$C_{12}H_{10}$	0	0	0.006	0.565	0.525	0
C	0	0	0	0	0	1.0

Table 6.24 Troubleshooting checklist for delayed coker cycle problems [3]:

Foamover effects	Long coking cycles	Foamover causes
High coke drum pressure Plugging combination tower bottoms screen Coked heater tubes Coke lay-down on trays Plugged blowdown system	Watch full drum pressure during switch Use little water instead of big steam Add quench water to hold maximum drum pressure Avoid plugged steam inlet nozzle Steam purge through separate vent Aggressive use of the warm-up valve Plugged condensate drain line	Incompletely drained coke drum Low overhead vapor temperature Erroneous foam level indication Failure of silicone antifoam system Overfilling drums Pressure surges Foamover during steaming Putting a drum on circulation Caustic in coker charge
Coke Drum Warm-up Condensate Recovery	Coke Quality	
Do not send to refinery slop Wet condensate to FCCU feed Hot condensate to combination tower Green wax plugs system Environmental effects	High volatile combustible matter Coke too hard Drum overhead temperature Time and pressure affect hardness Shot coke	

6.15.1 Visbreaking Reactions

The principal reaction in visbreaking is thermal cracking of heavy hydrocarbons, since resins are holding the asphaltenes, which keep them attached to the oil. The cracking of resin can result in precipitation of asphaltene that could deposit in the furnace and also could produce an unstable fuel oil. The cracking severity or conversion is restricted by the storage stability of the final residual fuel. The possible reactions that occur in visbreaking are:

- Cracking of naphthens rings at a temperature above 900 °F (482 °C).
- Paraffinic side chain breaking that will also lower the pour point.
- Coke formation by condensation, dealkylation, dehydrogenation, and polymerization.
- Further cracking that is due to asphaltene and coke leaving the liquid phase (delayed coking).

6.15.2 Visbreaking Severity

The severity of visbreaking is defined by the following:

- Material produced that boils below 330 °F (160 °C) (conversion).

- Percent reduction in product viscosity (25–75%).
- Stability of residual fuel on storage.

6.15.3 Operation and Control

The feedstocks to visbreakers are usually atmospheric and vacuum residues from crude oil distillation. The heaviest components of crude oil are present with normal boiling point approaching 1400–2000 °F (760–1094 °C). These heavy components consist of complex ring structures of saturated and unsaturated hydrocarbons, which may also have long-paraffins-like side chains. The side chains cause the residue to have the waxy characteristics of high viscosity and high pour point. The heavy portions of crude oil may also contain substantial amounts of asphaltenes in solution.

As the heavy residuum is thermally cracked, the aliphatic side chains are split from the aromatic core of the asphaltenes and the continuous nature of the system holding the asphaltenes in solution is broken down. A limiting condition is attained where the asphaltenes will no longer stay in solution and will precipitate. Asphaltenes may also precipitate when lower molecular weight non-polar solvents such as paraffins are added to the visbroken residuum as cutter stocks.

The limiting condition for each heavy residuum is a function of its composition.

A factor that limits the conversion in visbreaking is coke laydown. Data have indicated an exponential rise in coke laydown with furnace temperature for feeds of varying carbon contents [8]. A possible way to reduce this effect is by injecting antifoulant into the residuum feed stock to allow higher conversion with less fouling of the furnace. Operating conditions for the soaking drum and furnace cracking processes are:

Soaking drum	800–830 °F (427–444 °C)
Furnace cracking	885–930 °F (475–500 °C)

Pressures vary widely, depending on the design. The inlet pressure may vary from 150–500 psig (10–36 bar). Fractionators operate at pressures that are similar to crude oil distillation columns. Figure 6.24 shows a typical visbreaking flow diagram. A residual feedstock is preheated and heated in a furnace to a temperature of 815 °F (435 °C) and is routed to the bubble column (fractionator). The soaker outlet is quenched with some heavy fuel that has been cooled in order to suppress the cracking in the bubble column. The column operates with a condenser pressure of 25 psig (2.74 bar).

A gas oil product is drawn from the column, and steam stripped to control the flash point. The gasoline and lighter materials exit at the top of the column. The unstabilized gasoline is drawn from the reflux drum and sent to a stabilizer column for stripping of the light petroleum liquids. The light cracked gases exit from the reflux drum and are sent to a treating unit to remove the H₂S.

The visbreakers do not have reactors as rather a drum or furnace coil is employed as a vessel to provide residence time for the cracking reactions to occur. The cracking reactions are endothermic and reaction heat is supplied by the furnace. Some elemental carbon structures are formed and deposited in the soaking device. The visbreaker fractionators are similar to crude distillation units. A side stripping column is used to recover the gas oil which is condensed by top reflux and a pump-around cooling circuit. The heavy fuel bottom product is sometimes steam-stripped with the stripper overhead returned to the bottom tray of the column. The soaking drum product (a liquid/vapor mixture) is quenched with some heavy fuel that has been cooled, and the quenched feed is introduced into the flash zone of the fractionator. Similar to crude distillation, a small liquid flow is maintained back to the flash zone. A pump-around cooler is used to condense the gas oil that is drawn off, and the

steam stripped in a side column. The unstabilized gasoline product from the reflux drum is sent to a stabilizer column for removal of the light hydrocarbon liquids.

There are many types of visbreaker units that are employed in the refineries. A visbreaker unit can be operated alone, one with vacuum flasher or a combination of visbreaker units with a thermal cracker. Figures 6.25, 6.26 and 6.27, respectively, show the process flow diagrams of the following:

- A typical visbreaker unit
- A typical visbreaker unit with vacuum flasher
- A typical combination visbreaker and thermal cracker.

6.15.4 Typical Visbreaker Unit

Figure 6.25 can be employed when viscosity reduction of residual streams is required so that the need for high-quality distillate cutter stock can be reduced in order to produce a commercial-grade residual fuel oil.

Here, the visbreaker unit is charged with atmospheric or vacuum residue. The charge is raised to the required reaction temperature in the visbreaker heater. The reaction is allowed to proceed to the desired degree of conversion in a soaking zone in the heater. Steam is injected into each heater coil to maintain the desired minimum velocity and residence time and to suppress the formation of coke in the heater tubes. After exiting the heater soaking zone, the effluent is quenched with a quenching medium to stop the reaction and is sent to the visbreaker fractionator for separation.

The heater effluent enters the fractionator flash zone where the liquid portion flows to the bottom of the tower and is steam-stripped to produce the bottoms product. The vapor flows up the tower and is cooled with a gas oil wash stream. The washed vapors then continue up the tower. Gas oil stripper feed, as well as pump-around, wash liquid and the gas oil to quench the charge are removed on a side draw-off tray. The pump-around can be used to reboil gas plant towers, preheat boiler feed water, and generate steam. The feed to the gas oil stripper is steam-stripped, and a portion is then mixed with visbreaker bottoms to meet viscosity reduction requirements.

The overhead vapors from the tower are partially condensed and sent to the overhead drum, where the vapors flow under pressure control to a gas plant. A portion of the condensed liquid is used as reflux in the

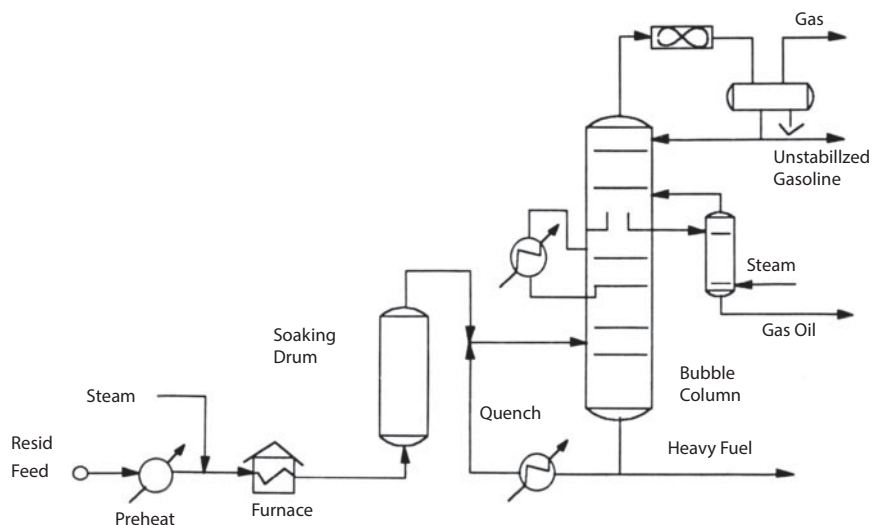


Figure 6.24 Process flow diagram of a visbreaker [1].

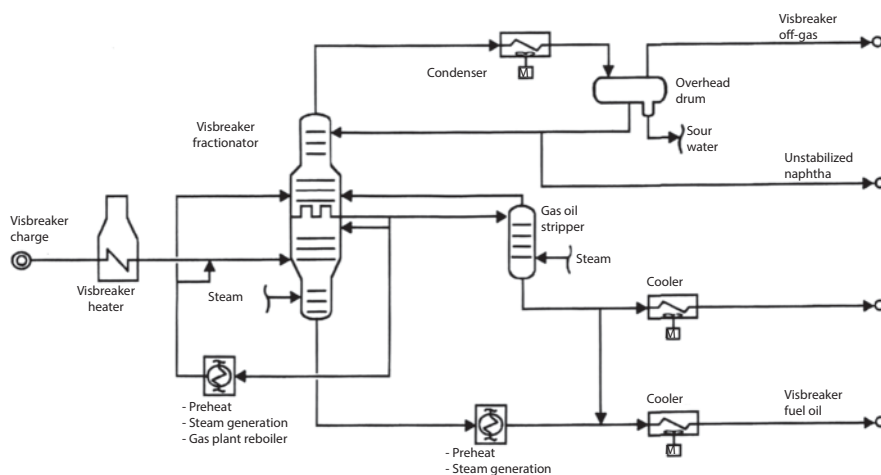


Figure 6.25 Process flow diagram of a typical visbreaker unit [9].

tower and the remainder is sent to a stabilizer. Sour water is withdrawn from the drum and sent to the battery limits.

6.15.5 Typical Visbreaker Unit with Vacuum Flasher

Here, the flow scheme is similar to the Figure 6.25 except that the visbreaker tower bottoms are sent to a vacuum tower where additional distillate products are recovered. This option may be desirable since a portion of the residual feed is converted to a cracking feedstock. Figure 6.26 shows the vacuum column, where the visbreaker bottoms are fed. The liquid portion of the

feed falls to the bottom section of the tower, where it is steam-stripped. The vapor portion rises through the tower wash section and then is partially condensed into distillate products. There are two side draws; on the lower draw-off, heavy vacuum gas oil (HVGO) product and pumparound along with wash oil are withdrawn. On the upper side, light vacuum gas oil (LVGO) and reflux are withdrawn. These are then combined to form a single vacuum gas oil product, which after visbreaker fuel oil viscosity reduction requirements are met. The overhead vapors from the vacuum tower flow to a three-stage vacuum ejector system and condensed vapors and motivating steam are retained in a condensate drum.

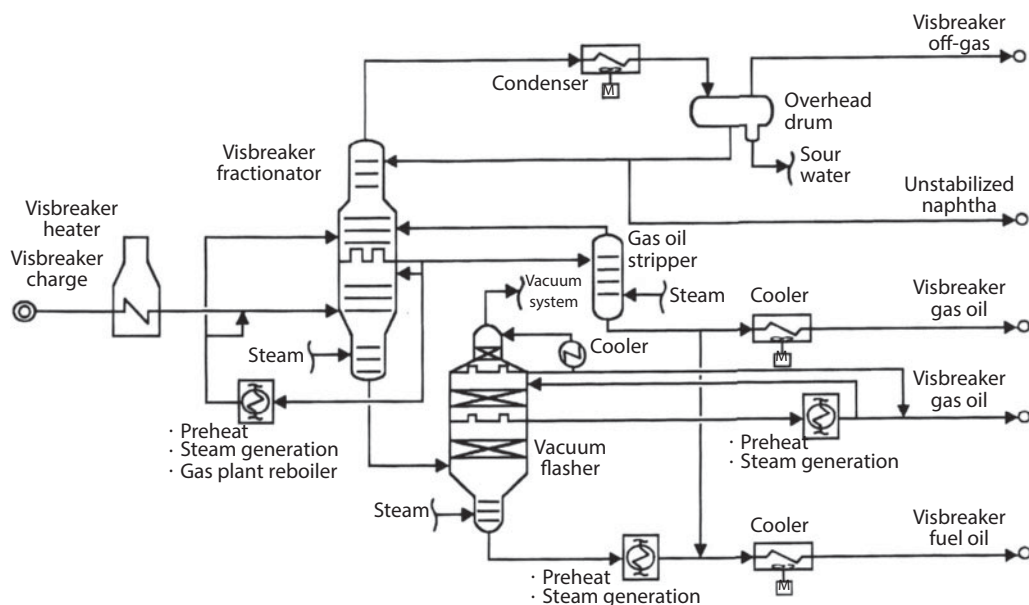


Figure 6.26 Process flow diagram of a typical visbreaker with vacuum flasher [9].

6.15.6 Typical Combination Visbreaker and Thermal Cracker

This scheme is similar to the Figure 6.26, except that the vacuum gas oil is routed to a thermal cracker heater (Figure 6.27). The vacuum gas oil is cracked and then sent to the visbreaker fractionating together with the visbreaker heater effluent.

A thermal cracking heater is used with a visbreaker when maximum light distillate conversion is desired or where extreme pour point reduction is required. Products from this scheme are a blend of heavy vacuum tar and visbreaker atmospheric gas oil, including a range of distillates. In cases where a high wax content feedstock is processed, extreme pour point reduction is necessary, and the total conversion of the visbreaker vacuum gas oil destroys all the wax it contains. This completely reduces the pour point of the resulting visbreaker fuel oil.

The principal reactions that occur during the visbreaking operation are [13]:

1. Cracking of the side chains attached to cycloparaffin and aromatic rings at or close to the ring so the chains are either removed or shortened to methyl groups.
2. Cracking of resins to light hydrocarbons (primarily olefins) and compounds that convert to asphaltenes.
3. At temperatures above 900 °F (480 °C), some cracking of naphthene rings. There is little

cracking of naphthenic rings below 900 °F (480 °C).

The severity of the visbreaking operation can be expressed as the yield of material boiling below 330 °F (166 °C), the reduction of product viscosity and the amount of standard cutter stock required to blend the visbreaker tar to No. 6 fuel or specifications as compared with the amount needed for the feedstock. In the U.S., the severity is expressed as the vol% product gasoline in a specified boiling range, and in Europe as the wt% yield of gas plus gasoline (i.e., product boiling below 330 °F (166 °C) [14].

Many of the properties of the product of visbreaking vary with conversion and the characteristics of the feedstocks. Some properties, such as diesel index and octane number are more closely related to feed qualities and others such as density and viscosity of the gas oil are relatively independent of both conversion and feedstock characteristics [15].

6.15.7 Product Yield

The products in a visbreaking process are: gases (C_4^-), Naphtha C_5-330 °F (C_5-166 °C), gas oil 330–660 °F (166–350 °C) and residue 600+ °F (350 + °C). Typical yields are shown in Table 6.25. Visbreaking results in an increase of °API of 2–5 for the vacuum residue feed and a reduction of viscosity of 25–75%.

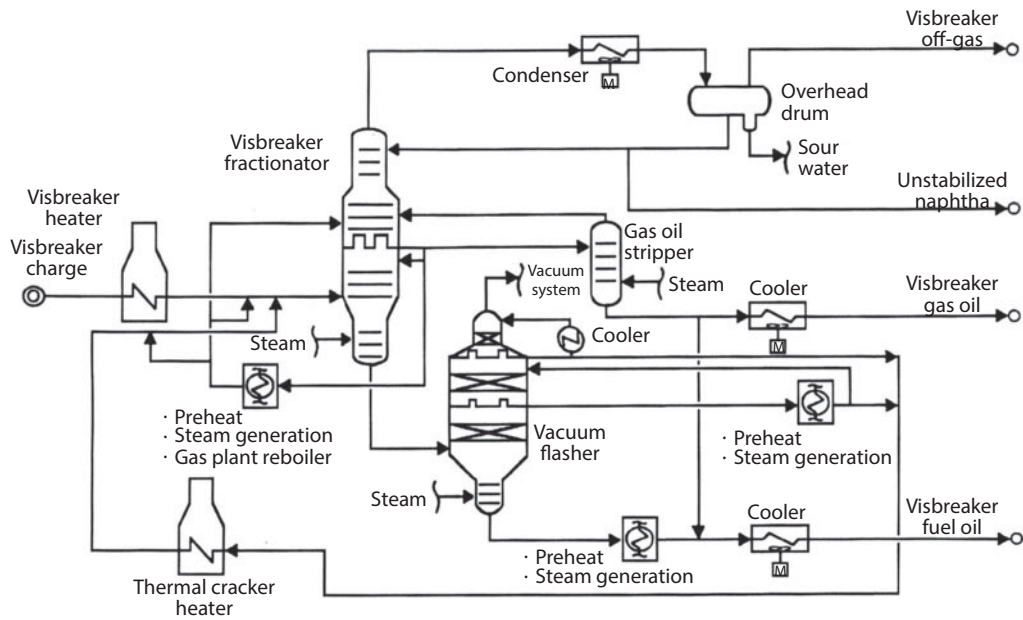
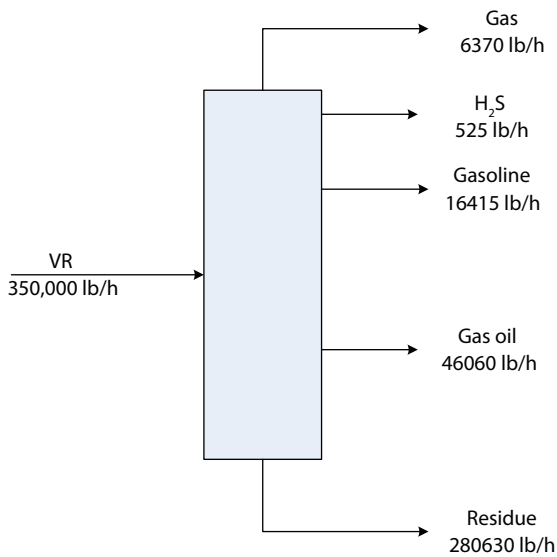


Figure 6.27 Process flow diagram of a combination of visbreaker and thermal cracker [9].

Example 6-3.



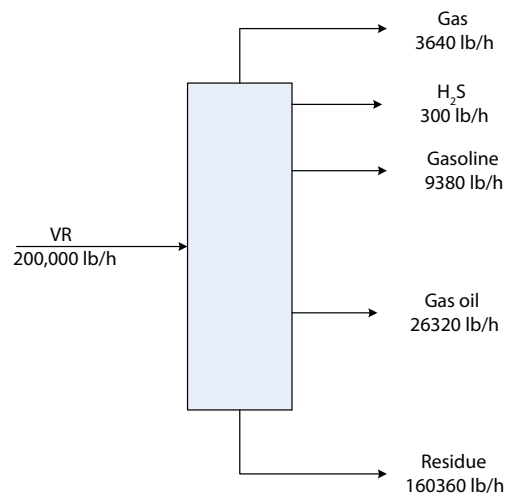
A vacuum residue is fed into a coil visbreaker at a rate of 350,000 lb/h. It has an API = 8.5 and sulfur content of 3 wt%. Assume 6 wt% conversion. Make a material balance for the visbreaker.

Solution

The result of this example for visbreaking is shown in Table 6.26 and Microsoft Excel program (Example 6-3.xlsx) shows calculations of Example 6.3.

Table 6.25 Typical yields of visbreaking process.

Product	wt% of charge
Gases (C ₄ -)	2-4
Naphtha (C ₅ - 330 °F)	5-7
Gas oil (330-660 °F)	10-15
Tar (600+ °F)	75-85



6.16 Process Simulation

The models are useful for troubleshooting and analysis of existing visbreaker operations. The operating

Table 6.26 Results of visbreaking example.

Feed rate = 350,000 lb/h		
Visbreaking Conversion = 6 wt%		
$S_f = 3$ wt%		
Feed °API = 8.5		
Rate of sulfur in the feed = 10,500 lb/h		
Products yield	wt%	lb/h
Gas wt% = $(0.189825 \text{ x\% Conv} + 0.677163)$	1.82	6370
Gasoline wt% = $(0.738321 \text{ x\% Conv} + 0.260174)$	4.69	16415
Residue wt% = $(-0.146668 \text{ x\% Conv}^2 - 2.203644 \text{ x\% Conv} + 98.677947)$	80.18	280630
H_2S wt% = $0.02023 \text{ x\% Conv} + 0.06043 \text{ x wt\% S} - 0.156$	0.15	525
Gas oil wt% = $100 - \text{Gas} - \text{Gasoline} - \text{Residue}$	13.16	46060
	98.18	350000
Sulfur in visbreaker products	wt%	lb/h
S in $H_2S = H_2S$ in gas (32/34)	94.12	494
S in Gasoline = $0.260112 S_f$	0.78	128
S in GO = $0.539924 S_f$	1.62	746.17
S in Residue = $(S \text{ Feed} - S \text{ in Gasoline} - S \text{ in Gas oil} - S \text{ in } H_2S)$	3.48	9765.92
		11134.1
Gravity of visbreaker products	°API	SG
Gasoline = $-0.26215 \text{ x\% Conv} + 0.31521 \text{ x API}_f + 56.83723)$	57.9	0.75
Gas oil = $-0.052919 \text{ x\% Conv} + 0.52228042 \text{ x API}_f + 12.9318914$	17.1	0.95
Resid = $-0.7462183 \text{ x\% Conv} + 1.29131825 \text{ x API}_f - 2.6831388$	3.8	1.05

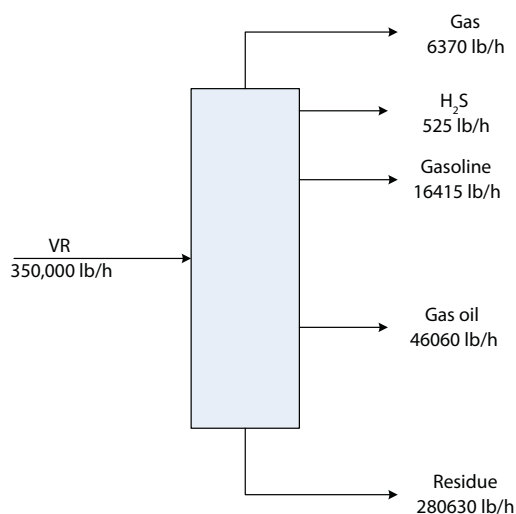


Figure 6.28 Mass balance of visbreaking.

condition for the visbreaking reactions are dependent on the composition of the heavy oil being processed and must be selected experimentally or based on previous operating data.

6.17 Health, Safety and Environment Considerations

Fire Protection and Prevention: Because thermal cracking is a closed process, the primary potential for fire is from leaks or release of liquids, gases or vapors reaching an ignition source such as a heater. The potential for fire is present in coking operations due to vapor or product leaks. Where coking temperatures become increasingly high or out of control, an exothermic reaction could occur within the coker.

Safety: In thermal cracking when sour crudes are processed, corrosion can occur where metal temperatures are between 450 - 900 °F (232 - 482 °C). Above 900 °F (482 °C) coke forms a protective layer on the metal. The furnace, soaking drums, and lower part of the tower, and high-temperature exchangers are usually subject to corrosion. Hydrogen sulfide (H_2S) corrosion in coking can also occur when temperatures are not properly controlled above 900 °F (482 °C).

Continuous thermal changes can lead to bulging and cracking of coke drum shells. In coking, temperature

control must often be held within a 10–20 °F range, as high temperatures will produce coke that is too hard to cut out of the drum. Conversely, the temperatures that are too low will result in high asphalt-content slurry. Water or steam injection may be used to prevent build-up of coke in a delayed coker furnace tubes. Water must be completely drained from the coker, so as not to cause an explosion upon recharging with hot coke. Provisions for alternate means of egress from the working platform on top of coke drums are important in the event of an emergency.

Health: The potential exists for exposure to hazardous gases such as hydrogen sulfide (H₂S) and carbon monoxide (CO), and trace polynuclear aromatics (PNA's) associated with coking operations. When coke is moved as slurry, oxygen depletion may occur within confined spaces such as storage silos, since wet carbon will adsorb oxygen. Wastewater may be highly alkaline and contain oil, sulfides, ammonia and or phenol. The potential exists in the coking process for exposure to burn when handling hot coke or in the event of a steam-line leak, or from steam, hot water, hot coke, or hot slurry that may be expelled when operating cokers. Safe work practices and the use of appropriate personal protective equipment may be required for exposure to chemicals and other hazards such as heat and noise, and during process sampling, inspection, maintenance and turnaround activities.

References

1. Keas, Gerald L, *Refinery Process Modeling - A Practical Guide to Steady State Modeling of Petroleum Processes*, 1st ed., The Athens Printing Company, Athens, Georgia, 2000.
2. Nelson, W. L., *Petroleum Refinery Engineering*, 4th ed., McGraw-Hill Series in Chemical Engineering, 1958.
3. Lieberman, Norman P., *Troubleshooting Process Operations*, 2nd ed., PennWell Books, PennWell Publishing Company, 1985.
4. Lieberman, Norman P., and Elizabeth T. Lieberman, *A Working Guide to Process Equipment*, McGraw-Hill Companies, Inc., 2008.
5. Bhaskar Rao, B. K., *Modern Petroleum Refinery Processes*, 5th ed., Oxford & IBH, 2008.
6. Feintuch, Howard, M., and Kenneth M. Negin, Chapter 12.2, FW Delayed – Coking Process, Robert A. Meyers, *Handbook of Petroleum Refining Processes*, 3rd ed., McGraw-Hill Companies, 2003.
7. Hughes, Gary C., Michelle, I. Wohlgenant, and Brian J. Doerksen, ConocoPhillips Delayed Coking Process, Robert A. Meyers, *Handbook of Petroleum Refining Processes*, 3rd ed., McGraw-Hill Companies, 2003.
8. Allan, D. E., *et al.*, “Visbreaking Gains Renewed Interest”, CEP, pp 85–89, January 1983.
9. Negin, Kenneth M., and Fred M. Van Tine, Chapter 12.3, FW/UOP Visbreaking Process, Robert A. Meyers, *Handbook of Petroleum Refining Processes*, 3rd ed., McGraw-Hill Companies, 2003.
10. Gary, James, H., Glenn E. Handwerk, and Mark, J. Kaiser, *Petroleum Refining Technology and Economics*, 5th ed., CRC Press, Taylor & Francis Group, 2007.
11. Maples, R. E., *Petroleum Refinery Process Economics*, PennWell Books, Tulsa, Oklahoma, 1993.
12. Hammond, D. G., *et al.*, Review of fluid coking and flexicoking technologies, *Petroleum Technology Quarterly*, 8(5), 27–33, 2001.
13. Rhoe, A., and C. de Blijnieres, *Hydrocarbon Process.*, 58(1), pp. 131–136, 1979.
14. Ramirez, R., *Chem. Eng.*, p. 74, February 24, 1969.
15. Chang, Ai-Fu, Kiran Pashikanti, and Y.A. Liu, *Refinery Engineering – Integrated Process Modeling and Optimization*, Wiley- VCH, 2012.
16. Fahin, M. A., T. A. Al-Shahhaf, and A. S. Elkkilani, *Fundamentals of Petroleum Refining*, Elsevier, 2010.
17. Zhorov, Y. H., *Thermodynamics of Chemical Processes*, MZR Publishers, Moscow, 1987.

7

Hydroprocessing

Introduction

Hydroprocessing is a term used to describe processes in which hydrocarbon reacts with hydrogen. This includes hydrotreating, hydrocracking and hydrogenation. The term hydrotreating is used to describe the process by which hydrogen in the presence of a catalyst is used to remove sulfur, nitrogen and heavy-metal impurities from the feedstock. This can be grouped into two sub-classifications. The first of these, often termed “hydropurification,” covers the removal from the feedstock molecules of sulfur, nitrogen, oxygen and/or heavy metals (e.g., Ni, V, As, etc.), the corresponding treatment processes referred to as hydrodesulfurization (HDS), hydrodenitrogenation (HDN), hydrodeoxygenation (HDO) and hydrodemetalization (HDM). The removal of these components means that the product molecules have improved properties and do not emit contaminants on combustion; the products can be further treated catalytically without poisoning the catalysts used. The second group of treatments known as hydroconversion involves changes in the molecular weights and structures of the treated molecules in processes such as hydrogenation (HYD),

hydrodearomatization (HAD), isomerization (ISM) and hydrocracking (HCG).

Hydrocracking is the process of catalytic cracking of feedstock with hydrogen to yield products with lower boiling points. Hydrogenation is employed when aromatics are saturated by hydrogen to yield naphthenes. Table 7.1 shows hydroprocessing methods, which depend on the type of feedstock and the desired products.

7.1 Catalytic Conversion Processes

Hydrocracking

Hydrocracking is a process for making high-quality kerosene and diesel oil by a catalytic hydrogenation process in which high molecular weight feedstocks are converted and hydrogenated to lower molecular weight products in the presence of excess hydrogen. The catalyst used comprises two parts: a metallic part that promotes hydrogenation and an acid part, which promotes cracking. Hydrogenation removes impurities in the feed such as sulfur, nitrogen and heavy metals (e.g., Ni, V, As, etc.). The cracking process breaks the bond

Table 7.1 Hydroprocessing methods

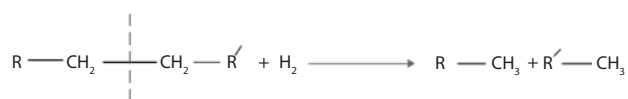
Feedstock	Products	Type of process	Impurities removal
Naphtha	Reformer feed	Hydrotreating	Sulfur
	LPG	Hydrocracking	
Atmospheric gas oil	Diesel	Hydrotreating	Sulfur, aromatics
	Jet fuel	Mild hydrocracking	Sulfur, aromatics
	Naphtha	Hydrocracking	
Vacuum gas oil	Low sulfur fuel oil (LSFO)	Hydrotreating	Sulfur
	FCC feed	Hydrotreating	Sulfur, nitrogen, metals
	Diesel	Hydrotreating, Hydrocracking	Sulfur, aromatics
	Kerosene/Jet	Hydrotreating	Sulfur, aromatics
	Naphtha	Hydrotreating	Sulfur, aromatics
	Lube oil	Hydrotreating	Sulfur, nitrogen, aromatics
Residuum	LSFO	Hydrotreating	Sulfur
	FCC feedstock	Hydrotreating	Sulfur, nitrogen, CCR and metals
	Coker feedstock	Hydrotreating	Sulfur, CCR,
	Diesel	Hydrocracking	metals

and resulting unsaturated products are hydrogenated into stable compounds. It is a high-pressure process operating normally around 2000 psig (138 barg). This makes the unit rather costly, which rather influences its importance in the industry compared with the fluid catalytic cracking unit (FCC) and thermal cracking. However, the process is very flexible as it handles a wide range of feedstocks. These are light vacuum distillates from other conversion processes: visbreaking, coking, hydroconversion of atmospheric and vacuum residues as well as deasphalted oils like vacuum gas oil. Its products require very little downstream treating to meet finished specifications. The naphtha stream it produces is particularly high in naphthenes, making it a good reformer stock for aromatic production. It is a highly flexible process that allows the best optimization of yields in desirable products and shows a high degree of selectivity. Figure 7.1 indicates the essential role hydrocracking plays as one of the main conversion processes in the refinery. It is mainly used to produce middle distillates of low sulfur content such as kerosene and diesel. If mild hydrocracking is employed, a low-sulfur fuel oil can be produced. It can also be used to remove wax by catalytic dewaxing and for aromatic removal by hydrogen saturation. The main feed to the hydrocracker unit is the vacuum gas oil (VGO), although a variety of feeds can be processed by the hydrocracking unit. Table 7.2 shows the various feedstocks used for

the hydrocracking process, as each type influences the final products.

7.1.1 Hydrocracking Chemistry

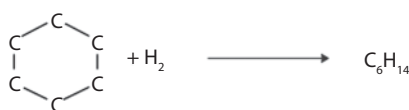
1. Alkane hydrocracking



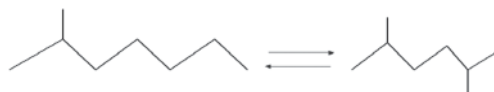
2. Hydrodealkylation



3. Ring opening



4. Hydroisomerization



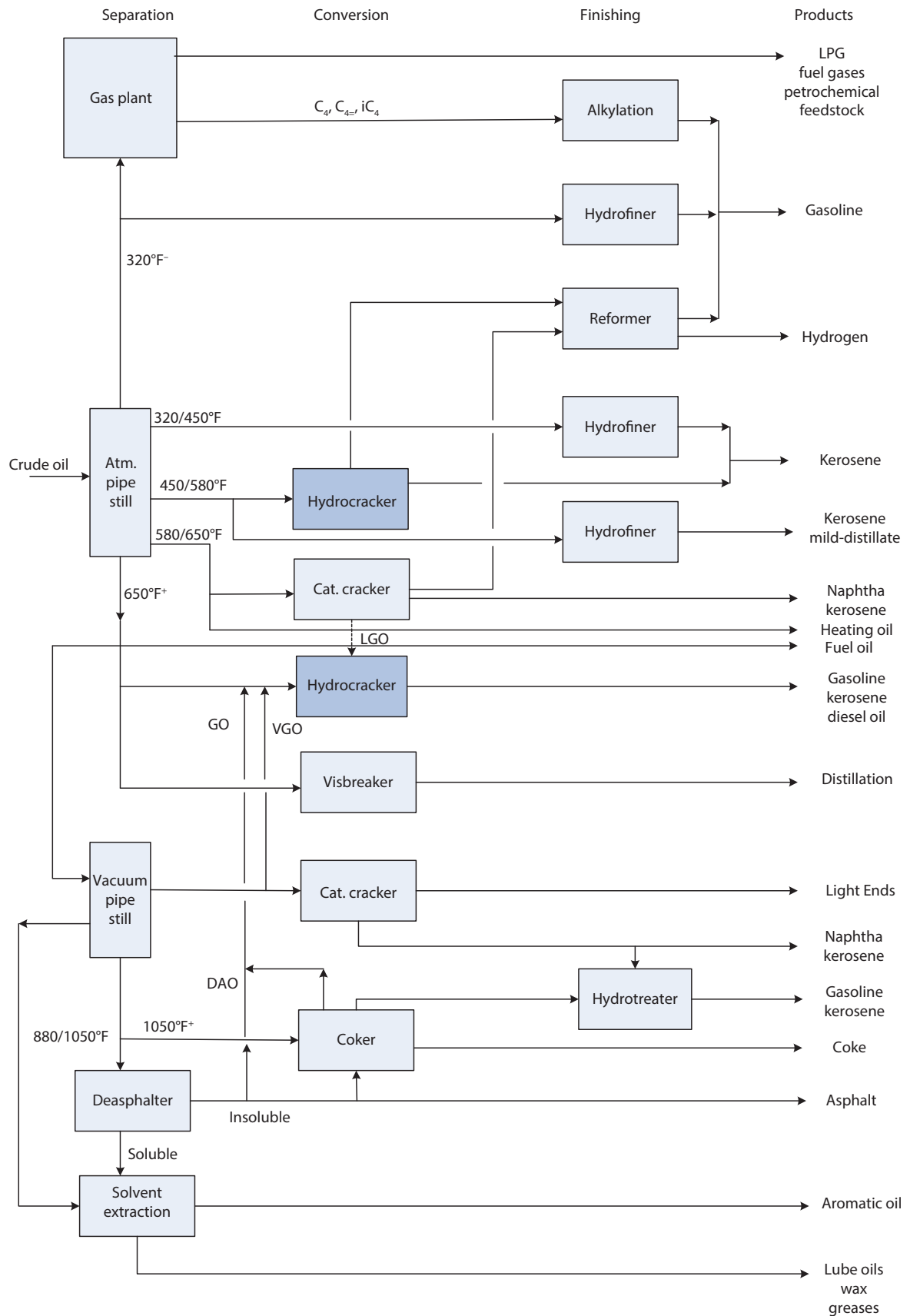
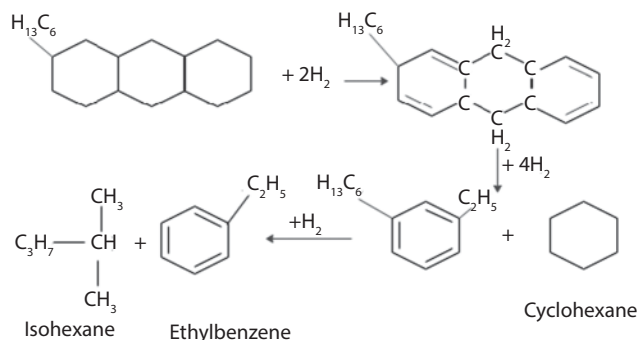


Figure 7.1 Role of the hydrocracker in the refinery (Source: Fahim, M. A., et al., *Fundamentals of Petroleum Refining*, Elsevier 2010).

Table 7.2 Feedstocks and products [1].

Feedstocks	Products
Kerosene	Naphtha
Straight-run diesel	Naphtha and/or jet fuel
Atmospheric gas oil	Naphtha, jet fuel, and/or diesel
Vacuum gas oil	Naphtha
FCC LCO	Naphtha
FCC HCO	Naphtha and/or distillates
Coker LCO	Naphtha and/or distillates
Coker HCO	Naphtha and/or distillates
Deasphalted oil	Olefin plant feedstocks

5. Polynuclear aromatics hydrocracking

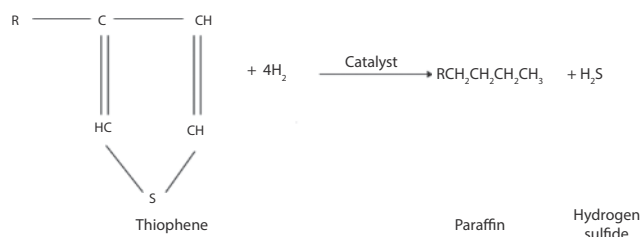


7.1.2 Hydrocracking Reactions

Distillate hydrocracking is a refining process for converting heavy gas oils and heavy diesels or similar boiling-range heavy distillates into light distillates such as naphtha, kerosene, diesel or base stocks for lubricating oil manufacture. The process involves reacting hydrogen with the feed in the presence of a catalyst under operating conditions as temperature, pressure and space velocity.

Desulfurization

In this process, the feedstock is desulfurized by the hydrogenation of the sulfur containing compounds to form hydrocarbon and hydrogen sulfide (H_2S). The H_2S is removed from the reactor effluent leaving only the hydrocarbon product. The heat of reaction for the process is ~ 60 Btu/scf of hydrogen consumed.



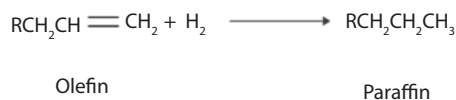
Denitrification

Nitrogen is removed from feedstock by the hydrogenation of nitrogen containing compounds to form ammonia and hydrocarbons. Ammonia is later removed from the reactor effluent, leaving only the hydrocarbons in the product. The heat of reaction of the denitrification reaction is $\sim 67\text{--}75$ Btu/scf of hydrogen consumed, but the amount of nitrogen in the feed is generally very small and thus its contribution to overall heat of reaction is negligible.



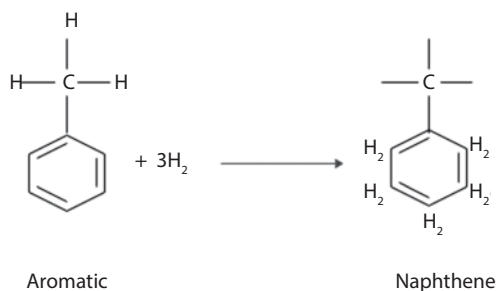
Olefin hydrogenation

The hydrogenation of olefin is a very rapid reaction that takes place as olefins are unsaturated. The heat of reaction ~ 140 Btu/scf of hydrogen consumed. Olefins content is generally small for straight-run products, but for stocks derived from secondary/thermal processes such as coking, visbreaking or resid hydrocracking, it can contribute a high amount of heat liberated in the hydrocracker reactor.



Saturation of Aromatics

Some of the aromatics in the feed are saturated forming naphthenes. Saturation of aromatics accounts for a significant proportion of both the hydrogen consumption and the total heat of reaction. The heat of reaction varies from $40\text{--}80$ Btu/scf of hydrogen consumed, depending on the type of aromatics being saturated. Generally, higher reactor pressure and lower temperature give a greater degree of aromatic saturation.



reactions often involve heavy molecules that contribute to the lowering of specific gravity and forming light products such as light naphtha and gas in the hydrocracker products. An example of the hydrocracking reaction is:



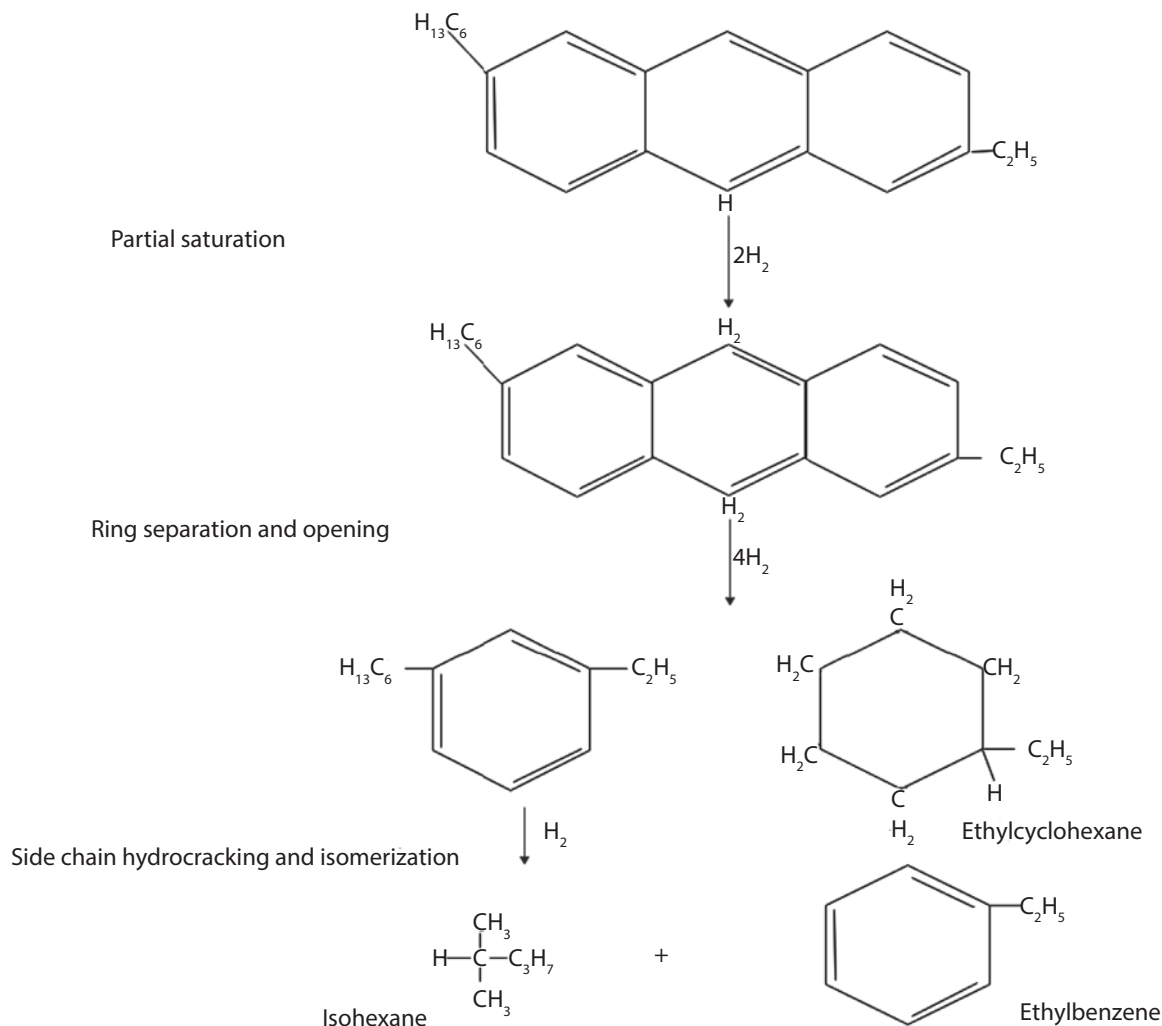
Hydrocracking of larger molecules

Hydrocracking of large hydrocarbon molecules to smaller molecules occurs in nearly all processes in the presence of hydrogen. The reaction gives out heat at ~ 50 Btu/scf of hydrogen consumed. The heat released from the hydrocracking reactions contributes appreciably to the total heat liberated in the reactor. Cracking

7.1.3 Typical Hydrocracking Reactions

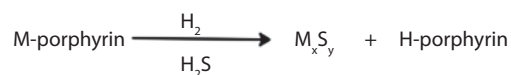
There are hundreds of simultaneous chemical reactions occurring in hydrocracking. However, the mechanism of hydrocracking is that of catalytic cracking with hydrogenation as exemplified by the following reaction.

The principal hydrogenolysis and hydrogenation reactions in catalytic hydrotreating are described as follows:



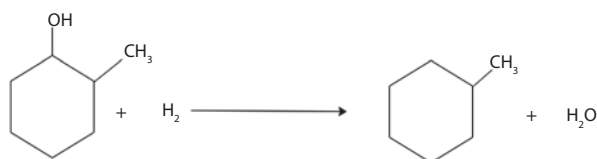
Hydrogenolysis reactions**Hetero-atom removal**

Hydrodemetallization (HDM): Removal of organometals and conversion to the respective metal sulfides. Nickel and vanadium being the most common metals present in petroleum. Hydrodemetallization is frequently subdivided into hydrodenizquelization (HDNi) and hydrodevanadization (HDV). Once metal sulfides are formed, they are deposited on the catalyst and contribute to irreversible deactivation.



M = predominantly Ni, V

Hydrodeoxygenation (HDO): Removal of organic oxygen compounds and conversion to water. Lower molecular weight oxygen compounds are easily converted, while higher-molecular weight oxygen can be difficult to remove. Phenol is one of the most difficult oxygen compounds to convert.



Hydrodesulfurization (HDS): Removal of organic sulfur compounds from a petroleum fraction and conversion to hydrogen sulfide (H_2S). Sulfur removal difficulty increases in the following order: **paraffins** < **naphthenes** < **aromatics**. The type of sulfur compounds can be classified as mercaptan, sulfides, disulfides, thiophenes, benzothiophenes, dibenzothiophenes, and substituted dibenzothiophenes. The ease of removal of these sulfur compounds is in the same order, the mercaptans being the easiest to remove and dibenzothiophenes the most difficult.



Hydrodenitrogenation (HDN): Removal of organic nitrogen compounds and conversion to ammonia (NH_3). Removal of nitrogen requires more severe reaction conditions than does HDS. The molecular complexity (five and six membered aromatic ring structures), the quantity and the difficulty of nitrogen-containing molecules to be removed increase with increasing boiling range of the distillate. Nitrogen compounds can be basic or nonbasic. Pyridines and saturated heterocyclic ring compounds (indoline, hexahydrocarbazole) are generally basic, where pyrroles are non-basic.

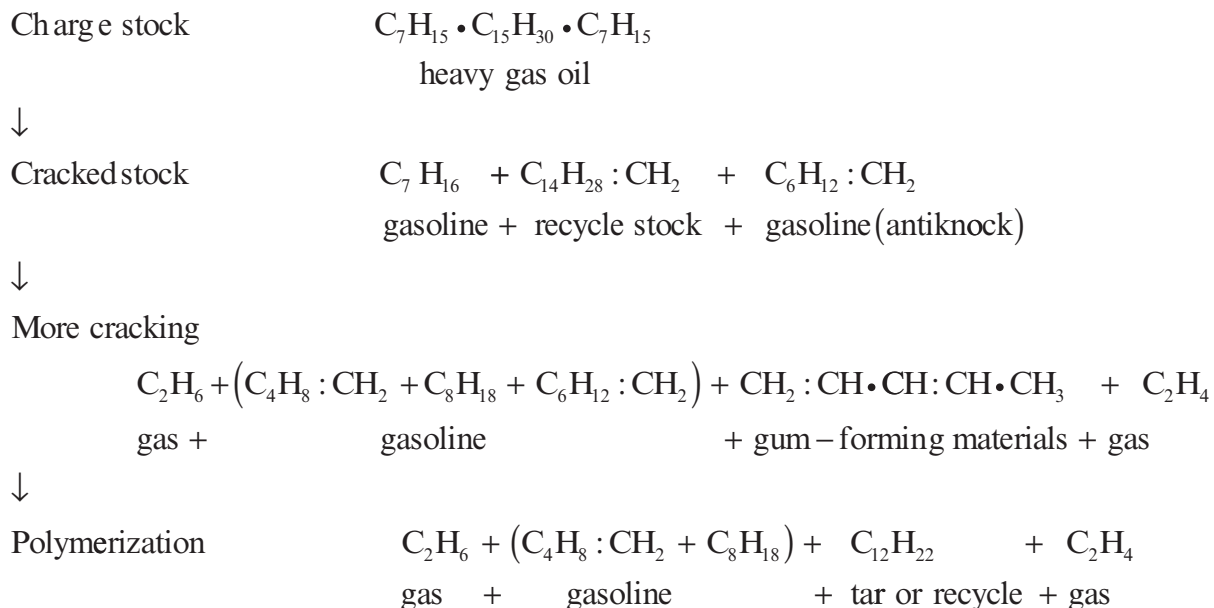


Aromatics saturation: Conversion of aromatic compounds to naphthenes. The aromatic compounds found in petroleum distillates are mono, di-, tri- and polynuclear aromatics. Monoaromatics are much more difficult to saturate than the others since their saturation requires more energy.

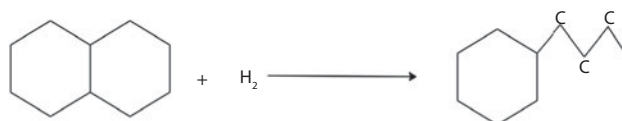


Hydrogenation reactions

Cracking: Cracking is a phenomenon where large oil molecules are thermally decomposed into smaller lower-boiling molecules; at the same time some of these molecules, which are reactive, combine with one another to give even larger molecules than those in the original stock. The more stable molecules leave the system as cracked gasoline, and the reactive ones polymerize, forming cracked fuel oil and even coke. Gasoline is the primary final product from cracking plants; however, the oils having boiling ranges intermediate between fuel oil and gasoline are also produced. These intermediate materials are referred to as “recycle stock” and are kept in the cracking system until they are decomposed. The production of intermediate stocks is illustrated by the following general chemical reactions:



Hydrodecyclization: The process of reducing the amount of cyclic structures present in a gas oil, which involves contacting a gas oil with hydrogen at elevated temperature and pressure using a catalyst comprising one or more Group VIII noble metal(s) on a support wherein the support comprises a modified Y-type zeolite.



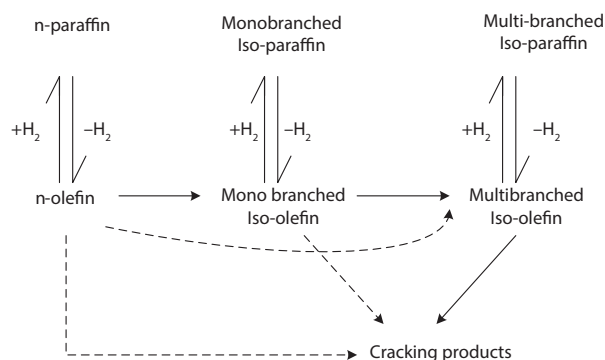
Hydrodealkylation: Removal of an alkyl group in the presence of hydrogen gas to form an aromatic hydrocarbon and saturated paraffin. An example is the hydrodealkylation of toluene (C_7H_8) with hydrogen (H_2) to produce benzene and methane (CH_4).



Hydrocracking: During hydrotreatment of light and middle distillates, some hydrocracking can occur, but its extent is normally low. However, when processing heavy feeds it can be very high. Hydrocracking is also a hydrogenolysis reaction where carbon-carbon bonds are broken.



Hydroisomerization: To reduce the content of linear paraffins in hydrocarbon mixtures, hydroisomerization to their branched isomers over bifunctional catalysts is a more sustainable process in the modern petroleum refining industry than selective hydrocracking (dewaxing) of long-chain n-paraffins. It has been applied for producing high-octane gasoline and low pour-point diesel as well as for improving the viscosity properties of waxy feedstocks such as slack waxes.



Simplified schematic reaction pathway for the hydroisomerization of n-paraffins.

7.2 Feed Specifications

The feed to the hydrocracker is typically heavy diesel boiling above the saleable diesel range or vacuum gas oil stream originating from the crude and vacuum distillation unit, atmospheric resid desulfurizers, coker units, etc. The hydrocracking catalyst is very sensitive to certain impurities as nitrogen, and heavy metals and therefore, the feed must adjust to the specifications laid out by the catalyst manufacturers to obtain a reasonable catalyst life.

Asphaltenes

In high-cut point vacuum distillation, high molecular-weight multi-ring aromatics (asphaltenes) can be found in vacuum gas oil distillates. This could cause excessive catalyst poisoning, and may be chemically combined with the catalyst to deactivate the catalyst permanently. Asphaltenes can undergo both types of reactions (hydrocracking and hydrogenation) depending on reaction conditions. At relatively low or moderate temperatures, the reaction is more hydrogenation dominated during hydrocracking of heavy residues. At high temperatures, hydrocracking is more prevalent. The overall conversion of asphaltenes is called hydro-deasphaltenization (HDA_{sp}).

Nitrogen Content

The nitrogen in the feed neutralizes catalyst acidity, and higher nitrogen requires slightly more severe

operating conditions such as temperature and causes more rapid catalyst deactivation. The organic nitrogen content of the feed is important as the hydrocracking catalyst is deactivated by contact with organic nitrogen compounds. An increase in organic nitrogen content of the feed causes a decrease in conversion.

Oxygen Content

Oxygenated compounds in the feed can increase deactivation of the catalyst. Also oxygen can increase the fouling rate of the feed effluent heat exchangers.

Chlorides

Some feed may contain trace amounts of organic and inorganic chlorides, which combine with ammonia produced as a result of denitrification reactions to form very corrosive deposits in the reactor effluent exchanger and process lines.

Hydrogen Sulfide

At low concentrations, the presence of hydrogen sulfide (H₂S) acts as a catalyst to inhibit the saturation of aromatic rings. This conserves hydrogen and produces a product with a higher octane number because the aromatic naphtha has a higher octane than does its naphthenic equivalent. However, hydrocracking in the presence of a small amount of hydrogen sulfide produces a very low smoke-point jet fuel. At the high hydrogen

sulfide levels, corrosion of the equipment becomes important and the cracking activity of the catalyst is also greatly affected.

7.2.1 Space Velocity

When the charge rate is low, the space velocity is low. Low space velocity at constant temperature increases conversion. The volumetric space velocity is the ratio of liquid flow rate in barrels per hour (m^3/s) to catalyst volume in barrels (m^3). At constant catalyst volume, the space velocity varies directly with feed rate. As the feed rate increases, the time of catalyst contact for each barrel of feed is decreased and so also is the conversion. In order to maintain conversion at the proper level when the feed rate is increased, it is important to increase the temperature. The space velocity is set by the catalyst manufacturer and will vary for the type of operation, the feed quality and the reactor temperature. The space velocity is the lowest in processing the lighter product. In naphtha production, the space velocity of 1.0 v/v/h is used while for diesel the space velocity of ~ 1.5 – 2.0 is common.

In general, the temperature should be lowered prior to lowering the charge rate in order to minimize the danger of a runaway reaction.

7.2.2 Reactor Temperature

Unlike thermal cracking and catalytic cracking, the temperature levels for hydrocracking are relatively low. The temperature at which the reactions are occurring is the primary variable available to control the reaction. An increase of reactor temperature increases the reaction rate, and a lower temperature decreases the rate of reaction. The reactor temperature is controlled by controlling the reactor feed temperature and by quenching (with hydrogen) to maintain internal reactor temperature.

Generally, the reactor inlet temperatures are between 700–750 °F (371–399 °C) at the start of a run to a maximum of about 950 °F (510 °C) towards the end. These temperatures depend upon the age of the catalyst and the type of operation (i.e., naphtha production, diesel production or jet fuel, etc.). Strict temperature control is essential in hydrocracking. However, due to the exothermic nature of catalytic reactions, the rate of reaction increases with an increase in temperature. Therefore, without the control of temperature, there is the possibility of the unit experiencing a temperature runaway situation with adverse consequences. Thus

the control is affected by injection of cold hydrogen streams into predetermined section of the reactor. A series of thermocouples is strategically installed in the reactor beds to monitor the temperature profile through the reactors.

7.2.3 Reactor Pressure

The reactor pressure is set by the requirement of a hydrogen partial pressure that the licensors and catalyst manufacturer have determined for the proper function of the catalyst. Generally, this partial pressure at the outlet of the reactor is required to be in excess of 1000 psig (69 barg) for most operations. This value is dependent on the reactor, the purity of the hydrogen at the outlet and the degree of hydrocarbon vapors present at this point. The reactor pressure thus becomes a variable in establishing and maintaining the hydrogen partial pressure and can be set for the plant and be controlled. For most operations, the reactor pressure is between 2000–2500 psig (138–172 barg) at the reactor inlet.

7.2.4 Hydrogen Recycle Rate

In general, the unit should be run at or near the maximum design, hydrogen recycled rate. The recycle rate is not normally used to control operation of the hydrocracker, except that a small change of total recycled rate occurs as a temperature change is made. The recycle rate is important for the flow regime in the air coolers, and therefore, should not be reduced below the design level.

The high hydrogen content gas from the high-pressure separator is recycled to the reactors and together with the make-up hydrogen it satisfies the partial pressure requirements of the process. Normally, this recycled stream will have a hydrogen content of 75–80% mol. The make-up stream is usually in excess of 95% mol. The recycle rate is set by the licensors to satisfy the partial pressure requirements and to ensure a satisfactory flow of hydrogen to “wash” the catalyst. The recycle rate depends on the type of operation and the catalyst type. Rates range from ~ 700 scf/bbl for middle distillates to 1000 + scf/bbl for light distillate production.

7.2.5 Oil Recycle Ratio

The oil recycle ratio is not used as a primary control. Increasing the oil recycle ratio tends to reduce the hydrogen consumption and thus reduces the light

product (e.g., gas, propane, butane, etc.) yields in favour of heavier (e.g., naphtha, kerosene, and gas oil) liquid product yields. Increasing the oil recycle ratio reduces the fresh feed processing capacity of the unit.

7.2.6 Heavy Polynuclear Aromatics

Heavy polynuclear aromatics (HPA) are formed in small amounts from hydrocracking reactions; when the fractionator bottoms are recycled, these can build up to concentrations that cause fouling of heat exchanger surfaces and equipment. Steps such as reducing the feed end point or removal of a drag stream may be required to control the problem [2].

7.3 Feed Boiling Range

An end point of feed distillation, which is higher than the desired could accelerate catalyst deactivation, and thus requires higher reactor temperatures, which invariably decreases the life of the catalyst. The properties of the feed do not directly affect the light product yield, but can affect the catalyst temperature required to achieve the desired conversion. By increasing the catalyst temperature, the yields of light gases (C_4) and naphtha boiling range material are also increased.

7.4 Catalyst

Hydrocracking reactions can be divided into two groups: 1. desulfurization and denitrification – hydrogenation of polyaromatics and mono-aromatics – are favored by the hydrogenating function of the catalyst (metals) and 2. Hydrodealkylation, hydrode-cyclization, hydrocracking, and hydroisomerization reactions are promoted by the acidic function of the catalyst support. This support function is affected by the nitrogen content of the feed.

The cracking function is provided by an acidic support, whereas the hydrogenation -dehydrogenation function is provided by active metals. The acidic support can be (a) amorphous oxides (e.g., silica-alumina), (b) a crystalline zeolite (mostly modified Y zeolite) plus binder (e.g., alumina, Al_2O_3) or (c) a mixture of crystalline zeolite and amorphous oxides. Cracking and isomerization reactions take place on the acidic support [3].

The metals providing the hydrogenation-dehydrogenation function can be noble metals (palladium, platinum) or non-noble metal sulfides from

Group VIA (molybdenum, tungsten) and group VIIIA (cobalt, nickel). These metals catalyze the hydrogenation of the feedstock, making it more reactive for cracking and heteroatom removal and reducing the coking rate. They also initiate the cracking by forming a reactive olefin intermediate via dehydrogenation. The ratio between the catalyst's cracking function and hydrogenation function can be adjusted to optimizing activity and selectivity.

The poisoning effect of nitrogen can be offset to a certain degree of operation at a higher temperature, but this tends to increase the production of material in the $C_1 - C_4$ range and decrease the operating stability of the catalyst so that it requires more frequent regeneration. Catalysts containing platinum or palladium (~ 0.5 per cent wt) on a zeolite base appear to be less sensitive to nitrogen than are nickel catalysts, and successive operation has been achieved with feedstocks containing 40 ppm nitrogen. Figure 7.2 shows a classification of hydrocracking catalyst, and Table 7.3 shows the relative strength of different hydrogenation components and cracking (acid) components in hydrocracking catalysts.

This catalyst is also more tolerant of sulfur in the feed which acts as a temporary poison; the catalyst recovers its activity when the sulfur content of the feed is reduced. This effect is shown in Table 7.4.

For maximizing the production of middle distillates or the conversion of lube oil blending stock, catalysts with amorphous supports are preferred. Amorphous hydrocracking catalysts contain silica-alumina. In hydroprocessing residues, amorphous hydrocracking catalysts as well as specially designed hydrotreating catalysts and iron-containing catalysts are used. For mild hydrocracking, catalysts have a composition similar to that of hydrotreating ones, as they consist of Group VI and VIII, non-noble metals supported by γ -alumina. The metals used are cobalt, nickel, molybdenum and tungsten in sulfided form. Under mild process conditions, gas oil hydrocracking catalysts may be used for mild hydrocracking and dewaxing catalysts usually consist of a hydrogenation metal (Pt, Pd, Ni) supported on a medium-pore zeolite combined with a binder, usually alumina.

The composition of a hydrocracking catalyst depends on the final product requirements and type of operation (e.g., one or two-stage). Table 7.5 provides a guideline of catalysts composition. In the first stage of a two-stage operation, a hydrocracking hydrogenation catalyst is used for hydrodesulfurization, hydrodenitrogenation, and aromatics removal. In the second stage, a

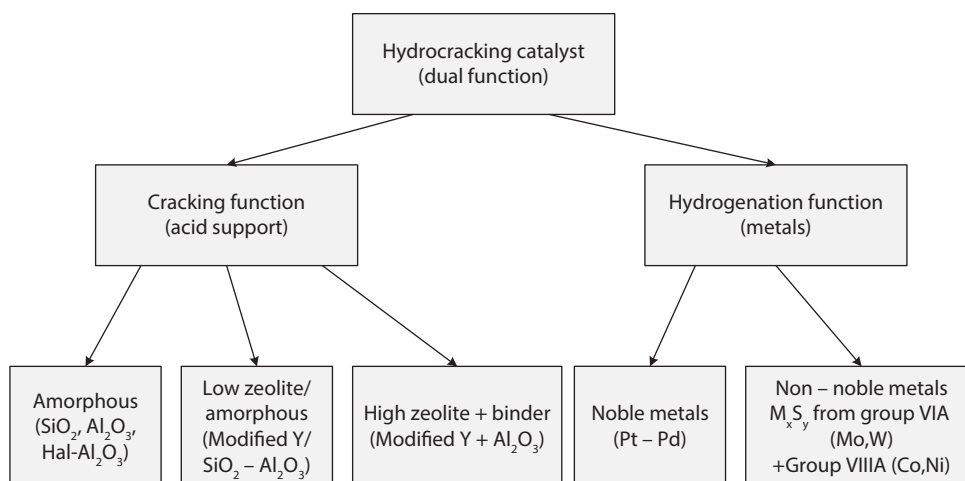


Figure 7.2 Classification of hydrocracking catalyst (Source: Secherzer, J., and A. J. Gruia, *Hydrocracking Science and Technology*, Marcel Dekker, New York, 1996).

Table 7.3 Bifunctional catalyst strength for hydrogenation and cracking [1].

Hydrogenation function	Co/Mo	Ni/Mo	Ni/W	Pt (Pd)
	x	xx	xxx	xxxx
Cracking function	Al ₂ O ₃	Al ₂ O ₃ - Hal	SiO ₂ - Al ₂ O ₃	Zeolite
	x	xx	xxx	xxxx

x represents order of strength

Table 7.4 Effect of Sulfur on Palladium/Zeolite catalyst.

Days on stream	51	59	64
Feed. S. % wt.	0.04	0.5	0.04
Temperature to maintain constant conversion, °C	327	340	325

hydrocracking catalyst is used for a hydrocracking and hydroisomerization. Table 7.6 shows the type of catalysts used for mild and high conversion hydrocracking as well as FCC and hydrotreating catalysts.

The catalyst used in hydrocracking is (Ni-Co-Fe), (Mo-W-U) on a silica/alumina support. The ratio of alumina to silica is used to control the degree of hydrocracking, hydrodealkylation, hydroisomerization and hydrodecyclization. Cracking reactions increase with increasing silica content of the catalyst. Metals in the form of sulfide control the desulfurization, denitrification, and hydrogenation of the olefins, aromatics, etc.

The catalyst choice is dependent on the feedstock to be treated, and the products required. A suitable

system is obtained using two or more catalysts with different acidic and hydrogenation functions. The reactor may also contain a small amount to 10% of desulfurization and denitrification catalyst in the last bed of the reactor.

The yield of the light hydrocarbon is dependent upon the temperature, and therefore the amount of light end products increases significantly as the reactor temperature increases, which then compensates toward the end of run conditions.

7.4.1 Catalyst Performance

The performance of all catalyst systems gradually deteriorates over a period of time, and it is essential to monitor the performance so that the rate of performance fall-off can be ascertained in order to determine when the catalyst should be regenerated or replaced, or to identify an abnormal rate of deterioration due to some cause that may be rectified. Furthermore, as the catalyst performance changes, the optimum operating conditions of the catalyst will change. Thus, it is important at the design stage to provide adequate means for monitoring catalyst performance. There are two aspects of catalyst performance that can be monitored; these are the apparent activities of the catalyst and the pressure drop across the reactor.

7.4.2 Loss of Catalyst Performance

The loss of either activity or selectivity can be sufficient to require catalyst discharge or reactivation.

Table 7.5 Types of catalyst used in different hydrocracking processes [4].

Application type	Process type (\neq stage)	Hydrogenerating function			Acid function	
		Pd	Ni-Mo	Ni-W	Y-type zeolite	SiO ₂ /Al ₂ O ₃ amorphous
Max. Naphtha	One	xxx	x	x	xxx	
Max. Naphtha	Two	xxx			xxx	
Max. Kerosene	One		xxx	x	xxx	
Max. Kerosene	Two	x	x	x	x	x
Max. Diesel oil	One		x	x	x	x
Max. Diesel oil	Two		x	x		x
Max. Lube oils	One		x	x	x	x

x represents frequency of use.

Table 7.6 Catalysts used for VGO treatment [1]

High conversion hydrocracking	Bifunctional	A H	Amorphous Silica-Alumina Zeolite Pd, Pt Ni (Co), Mo (W)
Mild hydrocracking	Mono-functional or bifunctional	A H	Amorphous Silica-Alumina Alumina Ni (Co), Mo (W)
FCC	Mono-functional	A	Zeolite + Amorphous Silica- Alumina
Hydrotreating	Mono-functional	H	Ni (Co), Mo (W)

Various aspects of catalyst deactivation are well covered in the literature [19], with much detailed work on the causes of decay and modeling of catalyst performance during life. It is useful to distinguish between temporary and permanent loss of performance activity, i.e., between cases where catalyst performance can be recovered (usually by reactivation in the plant), and those where it cannot (Table 7.7). Wide variations of catalyst life occur that depend upon the process and including temporary and permanent lives together, the range of catalyst lives covers more than 10⁸ to 1.

A technique of coping with declining catalyst activity is temperature ramping to maintain constant conversion (or reactor output) is widely used. For example, an increase in reactor temperature from 300–310 °C compensates for a 25% loss of catalyst activity in a reaction with activation energy of 84 kJ/mol. However, this method is unsuitable for drastic falls in activity.

7.4.3 Poisoning by Impurities in Feeds or Catalysts

Impurities in the feed or catalysts can affect catalyst performance when their interaction with the catalyst is stronger than that of the feed. The active site of the catalyst reaction or less often, the pore structure giving access to the active site is modified in some way so that catalyst performance is altered, as implied by the use of the word “poison.” Thus, the overall catalyst activity is reduced without affecting selectivity when some of the sites are totally deactivated while others are unaffected. However, if some active sites are modified without losing all activity, then the relative rates of different reactions may change to give different catalyst selectivity.

In some cases, plant maloperation can cause catalyst fouling, e.g., carry-over of CO₂ – removal liquor into the methanation reactor, with consequent loss of catalyst performance. This is distinct from poisoning because the transient impurity levels are much

Table 7.7 Typical lives of some catalysts used in oil refining [19].

Process and typical condition	Typical catalyst	Life ^a /years	Common cause of decay and catalyst property affected
Distillate oil hydrodesulfurization: 300–400 °C 5–100 bar	Co/Mo sulfides/ Al ₂ O ₃ extrusions	T 1-2 P 2-8	Coking: activity, pressure drop
Residual oil hydrodesulfurization 250–400 °C 100 bar	Co/Mo sulfides/ Al ₂ O ₃ extrusions	P 0.5 - 1	Coking and metal (V, Ni) deposition: activity, selectivity, pressure drop
Hydrocracking Heavy oil: 250–400 °C 100–200 bar	Ni/W sulfides/ Al ₂ O ₃ + SiO ₂ /Al ₂ O ₃ (Pd/zeolites) extrusions	T 1–5 P 1 - 10	Coking, metal deposition: activity, selectivity, pressure drop
Catalytic reforming: 450–550 °C 5–50 bar	Pt/Re/Al ₂ O ₃ /Cl ⁻ Spheres, extrusions	T 0.01–0.5 P 2 - 15	Coking, Pt sintering: activity, selectivity
Fluid catalytic cracking: 500–600 °C 1–3 bar	Zeolite/SiO ₂ – Al ₂ O ₃ matrix microspheroids	T 10-8–10-9 P 0.1	Coking, metal deposition, loss of zeolite structure: activity, selectivity
Ethylene oxidation C ₂ H ₄ + 1/2 O ₂ → C ₂ H ₄ O 200–300 °C 10–20 bar	Ag/α- Al ₂ O ₃ / Promoters ring	P 1 - 4	Slow sintering: activity, pressure drop

^aP = permanent loss of catalyst performance; T = temporary loss of catalyst performance, recoverable (at least partly) by regeneration.

higher. The initial mode of reaction of most poisons is that of strong adsorption on the active site. Therefore, the poisoning effect may be due to a blocking action. The poison by being more strongly adsorbed prevents the reactants from being adsorbed and converting to products.

The types of impurities which can act as poisons depend on the chemical nature of impurity and active sites, since strong chemisorption is the main feature of the poisoning section. Table 7.8 shows significant poisons of industrial catalysts.

The distribution of poison both within the reactor and across the catalyst particle is determined by the kinetics of the poisoning reaction and the mobility of the poison. It is frequently found that poisons are taken up preferentially near the inlet of the reactor (where this occurs it allows the use of guard beds to remove the poisons), giving a “front,” which slowly progresses through the reactor (Figures 7.3 and 7.4).

The most direct way of resolving catalyst poisoning is the purification of reactor feeds and the catalysts themselves. Special process stages are used specifically

Table 7.8 Some typical poisons of industrial catalysts [19].

Poison	Catalysts	Processes
CO	Pd, Pt	Hydrogenation
H ₂ S, AsH ₃ , PH ₃	Co, Ni, Pd, Pt, Cu	Hydrogenation, steam reforming, catalytic reforming, methanol synthesis LT CO shift
H ₂ S (high levels)	Fe ₃ O ₄	HT CO shift
Na, NH ₃ , organic bases	SiO ₂ /Al ₂ O ₃ , zeolites	Catalytic cracking, Hydrocracking
Transition metals (V, Ni)	SiO ₂ /Al ₂ O ₃ , zeolites Co/Mo sulfides	Catalytic cracking, Hydrocracking, hydrodesulfurization
Fe, Ni carbonyls	Ag	Methanol oxidation to formaldehyde
Pb, Hg, Zn	Most transition metals	Many

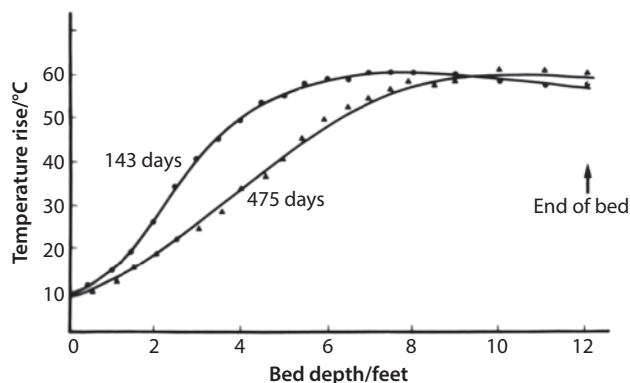


Figure 7.3 Temperature rise at different times in a bed of catalyst that is subject to sintering.

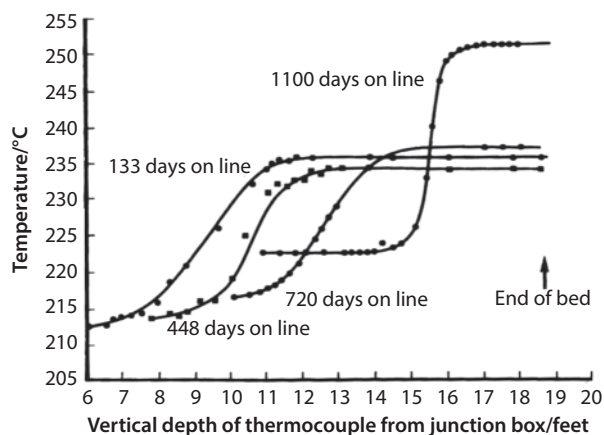


Figure 7.4 Variation of temperature profile with time for the poisoning of low temperature shift catalyst. A front slowly progresses through the reactor.

to achieve this such as hydrodesulfurization to protect nickel catalysts in steam reforming. Other process stages may also achieve dealing with catalyst poisoning as the methanation stage, which is designed to convert CO and CO₂ to methane to prevent poisoning of ammonia catalyst, will also remove traces of H₂S reaching this stage.

7.4.4 The Apparent Catalyst Activity

The apparent loss of catalyst activity can be broadly identified as [19]:

- a. Poisoning/sintering
- b. Poor gas distribution
- c. Poor mixing of reactants

Poisoning/sintering

Catalyst deactivation results from an ingress of poison or loss of surface area of the active phase through

sintering. It is possible to regenerate a catalyst by removing poisons. Well-designed catalysts only sinter very slowly at normal operating temperatures. But sintering can occur at normal catalyst operating temperatures if particular poisons are present. Because the catalyst structure is destroyed by sintering, usually it is impossible to regenerate the catalyst. In terms of activity, the effects on overall catalyst performance of poisoning and sintering are similar, and it is not readily easy to distinguish, which is causing the fall-off in apparent activity.

7.5 Poor Gas Distribution

This can occur in large catalyst beds due to uneven packing of the bed caused by incorrect charging; e.g., pouring the catalyst into the vessel in one spot, which causes the voidage to vary across the bed. Poor gas distribution is normally only a problem in reactors, which have a high conversion such as desulfurization and methanation reactors.

7.6 Poor Mixing of Reactants

This can be a problem in primary and secondary reformers where reactants are mixed before contacting the catalyst. In the primary reformer, if the distance between the mixing point and the split of the gases between the headers and tubes is too small, then different areas of the reformer may not be supplied with feed having the same steam to the carbon ratio. This will give a worse performance of the reformer than with good mixing, and in extreme cases could lead to carbon lay down in some tubes.

In the secondary reformer, air reacts with partially reformed gas in a flame before passing over the catalyst. There is a problem in some “gas-ring” type burners that parts of the burner may become overheated and break away, giving non-uniform air concentration and temperature gradient through the secondary reformer and an undesired high methane slip.

7.7 The Mechanism of Hydrocracking

The mechanism of hydrocracking is complex as several reactions occur in the process almost simultaneously. The important ones are as follows:

1. Long-chain paraffins are isomerized and then cracked into light isoparaffins.
2. Monocyclic naphthenes are dealkylated and then isomerized into light isoparaffins and low molecular weight naphthenes.
3. Bicyclic naphthenes are reacted to open one ring to alky-substituted monocyclic naphthenes which then follow reaction 2.
4. Alkylbenzenes are dealkylated to form aromatics. Isoparaffins are produced by combining the alkyl groups removed from the alkylbenzenes. Alkylbenzenes are also hydrogenated to form monocyclic naphthenes which also follow reaction 2.
5. Benzenenaphthenes react primarily by opening the naphthene ring to produce alkylbenzene which react as described in reaction 4. Benzenenaphthenes also undergo hydrogenation of the benzene ring to form bicyclic naphthenes which follow reaction 2.
6. Polyaromatics (two or more benzene rings) first undergo hydrogenation of one ring to form benzenenaphthenes. These in turn react as described in reaction 5.

Most of the reactions move away from the aromatic compounds to favour the production of the paraffin isomers and naphthenes. These provide products that are excellent cat reformer stock for gasolines and in petrochemicals, the benzene, toluene and xylene (BTX) precursors. Further, the breakdown of the polyaromatics and the heavier aromatics to essentially, paraffins and naphthenes forms the basis for excellent jet fuel (low smoke point) and diesel stock (high diesel index).

7.8 Thermodynamics and Kinetics of Hydrocracking

Thermodynamics

Paraffin and naphthenes hydrocracking, aromatic hydrogenation and aromatic hydrodealkylation reactions are all exothermic reactions and therefore, careful control of the reactor is essential. This is carried out by gaseous quenches in the reactor. Catalyst partitioning of the fixed bed must be applied, and Table 7.9 provides average heat of reaction at 400 °C (kJ/mole) of various reaction types.

Kinetics

The cracking reaction is generally described as a first-order reaction if the decomposition is limited as in conventional cracking operations to a low conversion per pass (20–25%). Assuming that the rate of a hydrocracking reaction follows n order, where

$$(-r_A) = kC_A^n = -\frac{dC_A}{dt} \quad (7.1)$$

Rearranging and integrating Eq. 7.1 between $t = 0$, $C_A = C_{AO}$, and $t = t$, $C_A = C_{Af}$ gives:

$$k \int_0^t dt = - \int_{C_{AO}}^{C_{Af}} \frac{dC_A}{C_A^n} \quad (7.2)$$

or

$$kt = -\frac{1}{(n-1)} \left[\frac{1}{C_{Af}^{n-1}} - \frac{1}{C_{AO}^{n-1}} \right] \quad (7.3)$$

where t is the reaction time (sec), k is the reaction rate constant (s^{-1}), C_{AO} is the initial concentration of the feedstock/or initial sulfur content in the feedstock (wt%), C_{Af} is the final concentration of the product/or the final sulfur content in the product (wt %), and n is the order of reaction. For a first order reaction, $n = 1$, Eq. 7.3 becomes

$$kt = -\ln \left(\frac{C_{Af}}{C_{AO}} \right) \quad (7.4)$$

In terms of fractional conversion X_A , where $X_A = \frac{C_{AO} - C_{Af}}{C_{AO}}$ Eq. (7.4) becomes

$$kt = -\ln(1 - X_A) \quad (7.5)$$

or

$$kt = \ln \left(\frac{a}{a - X} \right) = \ln \left(\frac{100}{100 - X} \right) \quad (7.6)$$

Table 7.9 Heat of reaction [4].

Reaction type	Average heat of reaction at 400 °C (kJ/mol)
Paraffin hydrocracking	-46 to -58
Naphthenes hydrocracking	-42 to -50
Aromatics hydrogenation	-210
Aromatics hydrodealkylation	-42 to -46

The first order ($n = 1$) is found for the narrow cuts (naphtha and kerosene), for $n > 1.0$ (1.5–1.7) is found for gas oil and $n = 2.0$ for VGO or residue. In Eq. 7.6,

- k = reaction rate constant, sec^{-1}
- t = time, sec
- a = percentage of material in feedstock for a pure feedstock $a = 100$
- X = percentage of material that disappears during the reaction time t

The reaction rate constant k can be determined by Arrhenius equation:

$$k = k_o \exp\left(\frac{-E_a}{RT}\right) \quad (7.7)$$

where

- k_o = Pre-exponential factor
- T = Absolute temperature, ($K = ^\circ C + 273.15$)
- R = Universal gas constant, 1.987 cal/mol K, 8.314 J/mol K
- E_a = Activation energy, cal/mol, J/mol.

	Catalyst	E_a , kJ/mol
1st stage	Pretreat	140

Table 7.10 Heat of reaction in hydrocracking reactors per tmol H_2 consumed.

	GJ/t mol H_2
Sulfur removal (general)	46
Aromatics saturation (general)	63
Olefin saturation (general)	126
Hetero atom removal (general)	58
Hydrocracking reactions (general)	58
Mono olefin saturation	121
Di-olefin saturation	144
Poly aromatics saturation (to mono)	21
Benzene nucleus hydrogenation	73
Mono naphthene ring opening	44
Normal to iso-paraffin hydrocracking	57
Normal to normal paraffin hydrocracking	50
Dealkylation to iso-paraffins	41
Dealkylation to normal paraffins	35
Tetralin ring opening	30
$nC_8 + H_2 \rightarrow 2nC_4$ (gas phase)	41

A composite average number for hydrocracking reactions is 58 GJ/t mol H_2 .

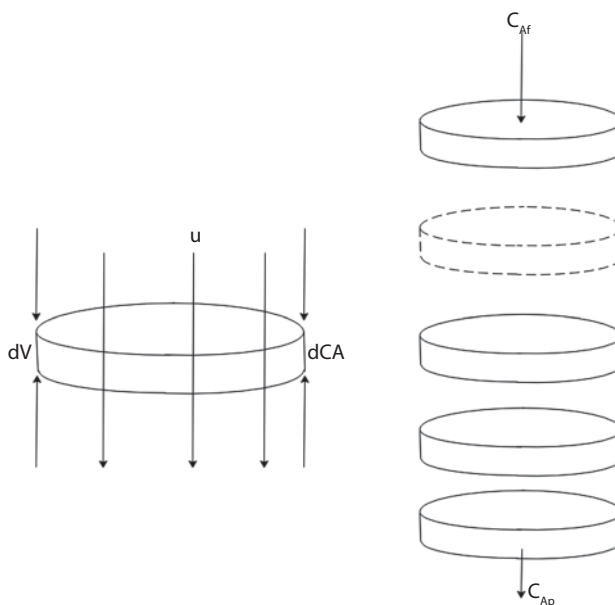


Figure 7.5 Flow through a plug flow system.

2nd stage	Cracking	E_a , kJ/mol
	Two - stage	170–250
	Series flow	210–290

Reactions occurring in hydrocracking reactors are highly exothermic and are illustrated in Table 7.10.

Figure 7.5 shows flow through a plug flow system, and the rate expression is as follows:

Kinetic expression derivations:

Differential mole balance on reacting component A

$$(-r_A) dV = u dC_A \quad (7.8)$$

where

- $-r_A$ = rate of reaction, (moles A/time)
- u = volumetric flow (volume/time)
- C_A = Concentration of A, (moles/time)
- V = Catalyst volume

General kinetics:



The rate of reaction with respect to reactant A is:

$$(-r_A) = kC_A^n C_{H_2}^m \quad (7.10)$$

For fixed hydrogen partial pressure:

$$(-r_A) = -\frac{dC_A}{dt} = kC_A^n \quad (7.11)$$

Since cracking usually follows a first order, then for a plug flow reactor and $n = 1$, the equation integrates to

$$k = SV \ln \left(\frac{C_{AO}}{C_A} \right) = SV \ln(1 - X) \quad (7.12)$$

For a plug flow reactor and $n \neq 1$, the equation integrates to

$$k = \frac{SV}{1 - n} \left(C_{AO}^{1-n} - C_{Af}^{1-n} \right) \quad (7.13)$$

Space velocity, SV is a process variable normally used to relate the amount of catalyst loaded within a reactor to the amount of feed. Space velocity is normally expressed on a volume basis (LHSV: liquid hourly space velocity) or a weight basis (WHSV: weight hourly space velocity). LHSV and WHSV are calculated as follows:

$$\text{LHSV} = \frac{\text{total volumetric flow rate to the reactor}}{\text{total catalyst volume}} [=] h^{-1} \quad (7.14)$$

$$\text{WHSV} = \frac{\text{total mass flow rate to the reactor}}{\text{total catalyst volume}} [=] h^{-1} \quad (7.15)$$

LHSV and WHSV are related to each other by the equation:

$$\text{WHSV} = \frac{\rho_{\text{oil}}}{\rho_{\text{cat}}} \text{LHSV} \quad (7.16)$$

where

ρ_{oil} and ρ_{cat} are the densities of the hydrocarbon feed and the catalyst respectively. When using LHSV as a process parameter, ρ_{cat} is not important. However, in the case of WHSV, ρ_{cat} becomes relevant since it can vary depending on how the catalyst is loaded to the reactor. For example, for dense loading, more catalyst is loaded in the same reactor volume and the WHSV value will be different than with nondense loading, although the LHSV value will be the same in both cases. In certain cases, space velocity is also used as the GHSV, which is determined by:

$$\text{GHSV} = \frac{\text{total volumetric gas flow rate to the reactor}}{\text{total catalyst volume}} [=] h^{-1} \quad (7.17)$$

In hydrotreating process, the space velocity is used as the LHSV. The space velocity is inversely proportional to the residence time. Therefore, an increase in space velocity indicates a decrease in the residence time and thus in reaction severity. Figure 7.6 shows a plot of conversion vs. residence time.

Fixed-bed catalytic reactors operate in both adiabatic and non-adiabatic conditions. If the heat of reaction

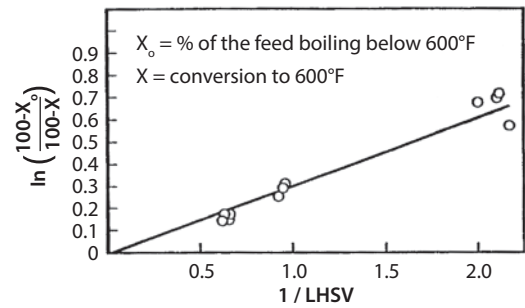


Figure 7.6 Sherzer and Gruia (Source: *Hydrocracking Science and Technology*, Marcel Dekker, New York 1996).

is small, then an adiabatic packed bed type reactor is used as a fixed-bed reactor. In such a reactor type, there is no provision for heat transfer. Reactions with a large heat of reaction and reactions that are extremely temperature sensitive are carried out in non-adiabatic reactors in which indirect heat exchange takes place by circulating the heat-transfer medium integrated in the fixed bed. The shell and tube type design is preferred for large heats of reaction, in which catalyst is inside the tubes and heat transfer medium is circulated on the shell side. Alternatively, multiple quench bed reactors can be used. When high pressure and high-temperature reactions are carried out with indirect heat exchangers, conversion per pass can be near equilibrium. However, in multiple quench bed reactors, the temperature of the final exit stream controls the conversion per pass.

The heart of a fixed-bed reactor and the site of the chemical reaction is the catalyst. The overall reaction taking place on the catalyst surface can be theoretically divided into the following steps:

1. Diffusion of the reactants from the gas space through the outer gas-particle boundary larger, macropores and micropores.
2. Chemisorption on active centers.
3. Surface reactions.
4. Desorption of the products.
5. Back-diffusion of the products into the gas space.

Also deactivation of catalyst due to fouling, poisoning and elevation in temperature must be considered. In the development of the rate equation, these steps are considered, which control the overall rate and other steps may be either neglected or combined. These steps do not necessarily proceed in series or in parallel, frequently making it impossible to combine them by simple means.

Consider the reversible catalyzed reaction $A \rightleftharpoons R$ and assume that the mechanism for this reaction is:



If desorption of R controls the overall rate, then the rate equation is:

$$(+r_R) = \frac{k \left(C_A - \frac{C_R}{K} \right)}{1 + k_A C_A} \quad (7.21)$$

where

- $(+r_R)$ = rate of formation of product R (overall)
- k = overall reaction rate constant.
- k_A = reaction rate constant for forward reaction.
- K = overall equilibrium constant for the chemical reaction

C_A, C_R = concentrations of A and R respectively.

All fixed-bed catalytic reactors are assumed to behave like ideal plug flow reactor. The design equation for sizing fixed-bed reactor is:

$$\frac{W}{F_{AO}} = \int_0^{X_A} \frac{dX_A}{(-r'_A)} \quad (7.22)$$

where

- W = Mass of catalyst, kg
- F_{AO} = Molar flow rate of limiting reactant in feed, kmol/s
- X_A = Fractional conversion of limiting reactant A.
- $\frac{\text{Moles of A reacted}}{\text{Moles of A in feed}}$
- $(-r'_A)$ = Overall rate of reaction in $\frac{\text{Moles of A reacted}}{\text{S. kg of catalyst}}$
- S = Surface area of catalyst, m^2/kg

7.9 Process Design, Rating and Performance

In the design of a catalytic reactor, three basic types of questions are asked.

1. What size (and possibly what kind) of reactor is needed for a particular duty?
2. Given a particular reactor, how will it behave under a given set of operating conditions?
3. Given a particular reactor and its behavior under a set of operating conditions, what is the activity of the catalyst?

These three classes of problems are used by the terms of design, rating and calculation of performance. There are a number of steps for designing a catalytic reactor once the kinetics and the catalyst performance with time have been determined. Figure 7.7 shows the calculation steps and their interdependence. The calculation steps are not carried out for every catalytic reactor design, as often the catalyst size and shape will be determined by the catalyst vendor, who will offer a limited range of catalysts suitable to a given duty. For a complex converter, process licensors offer appropriate designs. The remaining calculation steps are then carried out by the process licensor or engineering contractor and the calculated size of the reactor is finally checked by the catalyst vendor.

The procedure for calculating the process design parameter illustrated in Figure 7.7 will depend on the information that is already provided. The methods of calculating the process design parameters as outlined in Figure 7.7 are discussed by researchers [19]. Important aspects are:

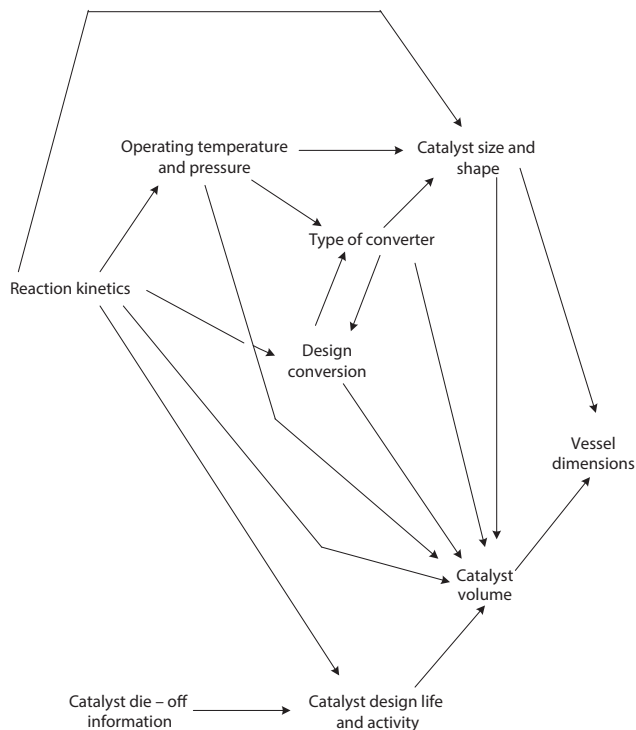


Figure 7.7 Schematic representation of the process steps for design of catalytic reactors (Source: Martyn V. Twigg, *Catalyst Handbook*, 2nd ed., Mason Publishing Ltd., 1996).

7.9.1 Operating Temperature and Pressure

Generating a flowsheet for a new plant requires major decisions, namely: operating temperatures and pressures of the reactors. The correct choice of operating conditions involves a large amount of work in determining the cost variations of the plant by changing these conditions. This is usually carried out employing licensed simulators and complex computer programs. However, it is possible to provide general guidelines for determining the operating conditions of particular catalysts and to explain the main factors that are taken into consideration in choosing them.

7.9.2 Optimum Catalyst Size and Shape

When the operating conditions of a catalytic reactor have been determined, it is important to decide the form of catalyst that should be used. The catalyst size and shape can be characterized by two independent variables: the voidage (ϵ) and the equivalent diameter of the catalyst particle (D_p) as defined by:

$$D_p = \frac{6 \times \text{volume of particle}}{\text{surface area of particle}} \quad (7.23)$$

Voidage

The shape of the catalyst particle will determine the voidage of the catalyst bed – the more eccentric the shape, the greater the voidage. The optimum voidage is determined by a trade-off between the cost of the containing vessel and the pressure drop through the bed. The greater the voidage, the larger is the vessel required and the smaller is the resultant pressure drop. Another factor that is taken into account is that the more eccentric the particles are, the more likely they are susceptible to breakage during the operation. In practice, the catalyst strength is an important factor. Table 7.11 shows typical voidages for some different particle shapes.

7.9.3 Pressure Drop (ΔP) in Tubular/Fixed-Bed Reactors

It is important to determine pressure drop of fluid through tubular reactors, such as packed, fixed and fluidized bed reactors where catalysts are employed. ΔP is an important factor that influences the design and operation of such reactors. Ergun [21] developed a useful ΔP equation arising from simultaneous turbulent

Table 7.11 Typical voidage of some catalyst shapes in vibrated catalyst beds [19].

Particle	Length	Hole diameter	Voidage
	Diameter	External diameter	
Spheres			0.360
Pellets	0.5		0.405
	1.0		0.355
	1.33		0.376
Rings	1.0	0.39	0.450
	0.68	0.39	0.460

kinetic and viscous energy losses that is applicable to all flow types. Ergun's equation relates the pressure drop per unit depth of packed beds to characteristics such as velocity, fluid density, viscosity, size, shape, surface of the granular solids, and void fraction. The original Ergun equation is:

$$\frac{\Delta P}{L} g_c = \frac{1.75(1-\epsilon)}{\epsilon^3} \cdot \frac{Gv}{D_p} + \frac{150(1-\epsilon)^2}{\epsilon^3} \cdot \frac{\mu v}{D_p^2} \quad (7.24)$$

where

- Δp = Pressure drop, lb_f/in², N/m²
- L = unit depth of packed bed, ft, m
- g_c = dimensional constant, 32.174 (lbf/lbm)(ft/sec²), lkg·m/N·sec²
- μ = viscosity of fluid, lb/(ft·hr), kg/(m·sec)
- v = superficial fluid velocity, ft/sec, m/sec.
- D_p = effective particle diameter, ft, m
- G = superficial mass velocity, lb/hr·ft², kg/sec·m²
- ϵ = void fraction of bed
- ρ = fluid density, lb/ft³, kg/m³

Equation 7.24 gives the total energy loss in fixed beds as the sum of viscous energy loss (the first term on the right side of the equation) and the kinetic or turbulent energy loss (the second term on the right side of the equation). For gas systems, approximately 80% of the energy loss depends on turbulence and can be represented by the second term of Equation 7.24. In liquid systems, the viscous term is the major factor.

For packed beds in either laminar or turbulent flow, the Ergun equation is:

$$\frac{dP}{dl} = -\frac{\rho v_s^2 (1-\epsilon)}{D_p \epsilon^3} \left\{ 1.75 + \frac{150(1-\epsilon)\mu}{D_p \rho v_s} \right\} \quad (7.25)$$

where

- D_p = effective particle diameter, ft, m
- $D_p = 6(1-\epsilon)/\phi_s S$, where $S = S_o(1-\epsilon)$ and $S_o = 6/D_p \phi_s$ where S_o is the surface area per unit volume of solid material in the bed and $\phi_s = 1$ for a spherical particle. Use six times the ratio of volume to surface area of the packing as an effective D_p .
- v_s = superficial fluid velocity, ft/sec, m/sec.
- ρ = fluid density, lb/ft³, kg/m³
- ϕ_s = shape factor of the solid, defined as the quotient of the area of a sphere equivalent to the volume of the particle divided by the actual surface of the particle.
- μ = viscosity of fluid, lb/(ft-hr), kg/(m.sec)
- ϵ = void fraction of bed

Equation 7.25 can be expressed in the form

$$-\frac{dP}{dl} = f \frac{\rho v_s^2}{g_c D_p} \tag{7.26}$$

where the friction factor is:

$$f = \frac{1-\epsilon}{\epsilon^3} \left[a + \frac{b(1-\epsilon)}{Re} \right] \tag{7.27}$$

with $a = 1.75$. $b = 150$ and $Re = \rho v_s D_p / \mu$

Hanley and Hegg [21] derived a value with $a = 1.24$ and $b = 368$. McDonald *et al.* [22] proposed that $a = 1.8$ for smooth particles and 4.0 for rough particles and $b = 180$. Hicks [23] reviewed various ΔP equations and inferred that the Ergun equation is limited to $Re/(1-\epsilon) < 500$ and Hanley and Hegg's equation to $1,000 < Re/(1-\epsilon) < 5,000$. He developed an equation for the friction factor for spheres, which is of the form

$$f = \frac{6.8(1-\epsilon)^{1.2}}{\epsilon^3} \cdot Re^{-0.2} \tag{7.28}$$

which fits Ergun's and Hanley and Hegg's data together with the results of Wentz and Thodos [24] at high Reynolds number. This shows that a and b are not true constants as stated by Tallmadge [25], who suggested that $a = 1.75$ and $b = 4.2 Re^{5/6}$

Equation 7.25 is also a good approximation for a fluidized bed reactor up to the minimum fluidizing condition. However, beyond this range, fluid dynamic factors are more complex than for the packed bed

reactor. Among the parameters that influence the ΔP in a fluidized bed reactor are the different types of two-phase flow, smooth fluidization, slugging or channelling, the particle size distribution, and the gas flow rate. After reaching a peak ΔP at the point of minimum fluidization, the ΔP of a smoothly fluidizing bed drops to a value that approximately corresponds to the static pressure of the bed and remains nearly constant despite an increase in the gas flow rate until the entrainment point is reached. A slugging bed displays a wide fluctuation in the ΔP beyond the point of minimum fluidization and a channelling bed exhibits a ΔP far below the bed static pressure. Figure 7.8 shows the behavior of fluidized beds in these three operation modes.

ΔP for laminar flow in a circular tube is given by the Hagen-Poiseuille equation:

$$-\frac{dP}{dl} = 8 \frac{v \mu}{R} \tag{7.29}$$

For turbulent flow, ΔP is calculate from

$$-\frac{dP}{dl} = 4 f_F \frac{1}{D} \frac{\rho v^2}{2} \tag{7.30}$$

$$\text{or } -\frac{dP}{dl} = f_F \left(\frac{\rho v^2}{R} \right) \tag{7.31}$$

where the Darcy friction factor is four times the Fanning friction factor, (i.e., $f_D = 4f_F$)

$$-\frac{dP}{dl} = f_D \left(\frac{\rho v^2}{4R} \right) \tag{7.32}$$

The Fanning friction factor is given by $f_F = 0.079 Re^{-0.25}$ and the Reynolds number is $Re = \rho v D_p / 6\mu(1-\epsilon)$ for a packed bed consisting of spherical particles and $Re = \rho v D_p \phi_s / 6\mu(1-\epsilon)$ for nonspherical particles. The

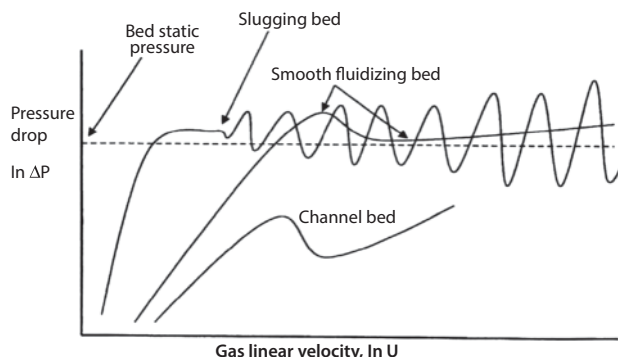


Figure 7.8 Relationship between ΔP and gas linear velocity.

values of ϕ_s for other materials are provided by Perry [26]. Industrial design problems often occur in tubular or packed bed reactors that involve the simultaneous solution of ΔP , energy and mass balances.

In most catalytic reactors on commercial plants, the flow is fully turbulent and so the Ergun equation 7.24 is simplified to give [19]:

$$\Delta P = 1.75 \frac{(1-\varepsilon) G^2 h}{\varepsilon^3 D_p \rho} \quad (7.33)$$

where ρ is the gas density and h is the height of catalyst in the bed. If no catalyst is packed in the dished ends, then h is given by:

$$h = \frac{4 V_b}{\pi D^2} \quad (7.34)$$

For a fixed-bed catalyst vessel with axial flow operating at a pressure greater than 10 bar the installed cost can be approximated by:

$$\text{vessel cost} = C_v V_c + C_d D^3 \quad (7.35)$$

where V_c is the volume of vessel exhibiting dished ends, D is the catalyst vessel diameter and C_v and C_d are constants which can be estimated [19]. Assuming that no catalyst is packed in the dished ends of the vessel, V_c is equal to the bulk volume of catalyst V_b and is:

$$V_b = V_s / (1-\varepsilon) \quad (7.36)$$

where V_s is the solid volume of the catalyst and

G is the mass flow rate for unit cross section of bed and is given by:

$$G = \frac{4M}{\pi D^2} \quad (7.37)$$

where M is the mass flow rate and D is the catalyst vessel size

During operation, beds of catalyst usually settle, so that the actual pressure drop is greater than that calculated by the Ergun equation. The pressure drop can be multiplied by a factor f to account for this. From Eqs. 7.33 to 7.37, the pressure drop is:

$$\Delta P = \frac{a V_b (1-\varepsilon)}{D^6 \varepsilon^3 D_p} \quad (7.38)$$

$$a = \frac{3.61 f M^2}{\rho} \quad (7.39)$$

The capitalized cost of pressure drop (CCPD) in a process stream is given by:

$$\text{CCPD} = (C_p) (\Delta P) \quad (7.40)$$

$$\text{and } C_p = \frac{t P L_p}{\text{CCF}} \quad (7.41)$$

where

t = running time of the plant in a year

P = cost of power

L_p = power lost per unit pressure drop through the catalyst

CCF = capital charge factor relates annual running costs to capital costs, and is the inverse of payback time.

The power lost per unit of pressure drop depends on where any pressure lost in the reactor must be made up by extra compression.

7.9.4 Catalyst Particle Size

As the catalyst size increases, the pressure drop through the reactor decreases. However, as the size is increased there comes a point where the catalyst activity is limited by diffusion within the particle. The total volume of catalyst must then be increased in order to maintain the same "effective volume." The optimum catalyst particle size is a compromise between the cost of the catalyst, the cost of the vessel and the cost of pressure drop through the bed.

In most commercial catalytic reactors, the catalyst is limited by pore diffusion rather than by film diffusion, and the effectiveness E of the catalyst depends on the Thiele modulus ϕ , which is:

$$\phi = \frac{D_p}{2} \left(\frac{\text{intrinsic reaction rate}}{\text{effective diffusivity of limiting reactant or product}} \right)^{1/2} \quad (7.42)$$

The Thiele modulus can be calculated at the average temperature in the bed and at the design activity of the catalyst and can be represented by:

$$\phi = b D_p \quad (7.43)$$

where b is a constant. For a spherical catalyst particle, the effectiveness is:

$$E = \frac{3}{\phi} \left[\frac{1}{\tanh \phi} - \frac{1}{\phi} \right] \quad (7.44)$$

In practice, Eq. 7.44 can be used for catalyst pellets and rings, as well as for spheres and b can be calculated directly from Eqs. 7.43 and 7.44 using data for the relative activities of two different sizes of catalyst pellets under the same operating conditions. The solid volume of catalyst required is:

$$V_s = V_a/E \tag{7.45}$$

V_a is the volume of catalyst needed for an effectiveness of unity. The capitalized cost of catalyst per unit volume (C_{cat}) is:

$$C_{cat} = \frac{\text{cost of catalyst per unit volume}}{\text{catalyst life} \times \text{CCF}} \tag{7.46}$$

7.9.5 Vessel Dimensions

After determining the duty required by the reactor—the particle size and shape have been chosen, the bulk volume of catalyst V_b has been calculated—the vessel dimensions can be determined.

The important parameters to be determined are the length to diameter ratio of the vessel and how much of the dished end is filled with catalyst. The optimum dimensions are a compromise between the vessel cost and the operational cost of pressure drop through the vessel.

Using Eqs. 7.35, 7.36, 7.38, 7.39 and 7.41, the optimum diameter of the vessel using consistent units is:

$$D = \left[\frac{2C_p a V_b (1-\epsilon)}{C_d \epsilon^3 D_p} \right]^{1/9} \tag{7.47}$$

Eq. 7.47 assumes that the reactor is adiabatic, flow is axial and that there is not bed height limitation due to crushing or channelling within the catalyst charge. It further assumes that the catalyst is not packed in the dished ends of the vessel. However, the size of a new catalyst vessel can be reduced if the catalyst is put part way into the dished ends. If a catalyst vessel is filled so that the minimum diameter of bed in the dished end is D_e as shown in Figure 7.9, then the optimum D_e is given by [19]:

$$D_e = \left[\frac{C_d \epsilon^3 D_p}{C_p a (1-\epsilon)} + \frac{1}{D^6} \right]^{-1/6} \tag{7.48}$$

If the vessel diameter has been optimized according to Eq. 7.47, then Eq. 7.48 can be simplified to give:

$$\frac{D_e}{D} = \left[\frac{2V_b}{D^3} + 1 \right]^{-1/6} \tag{7.49}$$

The height of the catalyst in a vessel when catalyst is put into dished ends will depend on their shape.

Example 7-1

A bed with a height 2.5 m and an internal diameter of 0.035 m is packed with cylindrical particles of diameter $D_p = 0.003$ m. The void fraction of the bed is $\epsilon = 0.33$. A gas of density $\rho = 0.9487$ kg/m³ and dynamic viscosity $\mu = 3.1 \times 10^{-5}$ Pa.s flows through the bed with a superficial mass flow velocity of 1.4 kg/m².s. Determine the pressure drop in the bed.

Solution

From Ergun's Eq. 7.24

$$-\frac{dP}{dl} = f \frac{\rho v_s^2}{g_c D_p} \tag{7.26}$$

where the friction factor f is:

$$f = \frac{1-\epsilon}{\epsilon^3} \left[a + \frac{b(1-\epsilon)}{\text{Re}} \right] \tag{7.27}$$

$a = 1.75$. $b = 150$ and $\text{Re} = \rho v_s D_p / \mu$

$$\begin{aligned} v_s &= \frac{1.4}{0.9487} \left(\frac{\text{kg}}{\text{m}^2 \cdot \text{sec}} \cdot \frac{\text{m}^3}{\text{kg}} \right) \\ &= 1.475 \text{ m/sec.} \end{aligned}$$

The Reynolds number, Re

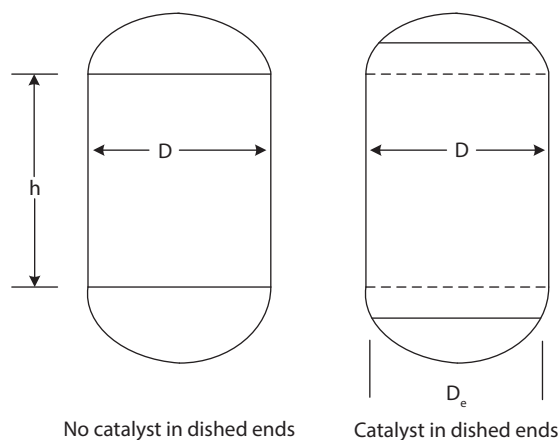


Figure 7.9 Design dimensions of catalyst vessels.

$$\text{Re} = \frac{\rho v_s D_p}{\mu}$$

$$= \left(\frac{0.9487 \times 1.475 \times 0.003}{3.1 \times 10^{-3}} \right) \left(\frac{\text{kg}}{\text{m}^3} \cdot \frac{\text{m}}{\text{sec}} \cdot \frac{\text{m}}{\frac{\text{kg}}{\text{m} \cdot \text{sec}}} \right)$$

$$= 135$$

The friction factor f from Eq. 7.27 is:

$$f = \frac{(1-0.33)}{0.33^3} \left[1.75 + \frac{150(1-0.33)}{135} \right]$$

$$= 46.5$$

The pressure drop $-\Delta P_t$ is

$$-\Delta P_t = f \frac{\rho v_s^2 L}{g_c D_p}, \frac{N}{\text{m}^2}$$

$$-\Delta P_t = 46.5 \frac{(0.9487)(1.475)^2 (2.5)}{(1)(0.003)} = 79,981 \text{ N/m}^2 = 0.799 \text{ bar}$$

McDonald *et al.* equation: $a = 1.8$, $b = 180$, $f = 50.2$ and $-\Delta P_t = 86,368 \text{ N/m}^2 = 0.86 \text{ bar}$

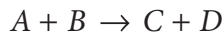
Hicks equation: $f = 43.9$ and $-\Delta P_t = 75,509 \text{ N/m}^2 = 0.755 \text{ bar}$.

Tallmadge equation: $a = 1.75$, $b = 4.2 \text{Re}^{5/6}$, $f = 55.76$ and $-\Delta P_t = 95,908 \text{ N/m}^2 = 0.959 \text{ bar}$

An Excel spreadsheet program (Example 7-1.xlsx) was developed to determine ΔP s of packed beds with known parameters.

Example 7-2 Packed Bed Reactor Design for a Gas Phase Catalytic Reaction [16]

The irreversible gas phase catalytic reaction is:



is to be carried out in a packed bed reactor with four different catalysts. For each catalyst, the rate expression has a different form as follows:

$$(-r'_{A1}) = \frac{kC_A C_B}{1 + K_A C_A} \quad (7.50)$$

$$(-r'_{A2}) = \frac{kC_A C_B}{1 + K_A C_A + K_C C_C} \quad (7.51)$$

$$(-r'_{A3}) = \frac{kC_A C_B}{(1 + K_A C_A + K_B C_B)^2} \quad (7.52)$$

$$(-r'_{A4}) = \frac{kC_A C_B}{(1 + K_A C_A + K_B C_B + K_C C_C)^2} \quad (7.53)$$

The molar feed flow rate of A is $F_{AO} = 1.5 \text{ g-mol/min.}$, and the initial concentration of the reactants are $C_{AO} = C_{BO} = 1.0 \text{ g-mol/dm}^3$ at the reactor inlet. There is a total of $W = 2 \text{ kg}$ of each catalyst used in the reactor. The reaction rate constant and the various catalyst rate parameters are given by:

$$k = 10 \text{ dm}^6/\text{kg} \cdot \text{min}$$

$$K_A = 1 \text{ dm}^3/\text{g-mol}$$

$$K_B = 2 \text{ dm}^3/\text{g-mol}$$

$$K_C = 20 \text{ dm}^3/\text{g-mol}$$

- Calculate and plot the conversion versus catalyst weight for each of the catalytic rate expressions when the reactor operation is at constant pressure. Summarize the expected outlet conversions.
- Determine the pressure profile against the catalyst weight.

Solution

The design equation for a packed bed reactor is:

Mole balance:

$$\frac{dX}{dW} = \frac{-r'_A}{F_{AO}} \quad (7.54)$$

Stoichiometry:

$$C_A = C_B = C_{AO}(1-X) \quad (7.55)$$

$$C_C = C_D = C_{AO} X \quad (7.56)$$

(b) When the pressure varies within the reactor, the stoichiometric equations relating the concentrations to conversion need to be altered to include the change of pressure by

$$C_A = C_B = C_{AO}(1-X)y \quad (7.57)$$

$$C_C = C_D = C_{AO} X y \quad (7.58)$$

The differential form of Ergun equation for the packed pressure drop in packed beds is:

$$\frac{dy}{dW} = \frac{-\alpha}{2y} \left(1 + \varepsilon X\right) \frac{T}{T_o} \quad (7.59)$$

where

$$\alpha = \frac{2\beta_o}{A_c \rho_c (1-\phi) P_o} \quad (7.60)$$

and

β_o is a constant down the reactor that depends only on the properties of the packed bed and the entrance conditions and is expressed by:

$$\beta_o = \frac{G(1-\phi)}{\rho_o g_c D_p \phi^3} \left[\frac{150(1-\phi)\mu}{D_p} + 1.7G \right] \quad (7.61)$$

A = cross sectional area

ρ_c = density of the solid catalyst particles

ϕ = $\frac{\text{volume of void}}{\text{total bed volume}}$ = void fraction

D_p = diameter of particle in the bed

G = ρu = superficial mass velocity

ρ_o = gas density at the entrance

g_c = $32.174 \text{ lb}_m \cdot \text{ft}/\text{s}^2 \cdot \text{lb}_f$ (conversion factor)
 = $4.17 \times 10^8 \text{ lb}_m \cdot \text{ft}/\text{h}^2 \cdot \text{lb}_f$

P_o = entering total pressure

P = pressure

T_o = entering temperature

T = temperature

y_{AO} = entering mole fraction of A

F_{AO} = entering molar flow rate of A

F_{TO} = total molar flow rate

δ = change in the total number of moles per moles of A reacted.

ε = $y_{AO} \delta$

$$\varepsilon = y_{AO} \delta = \frac{F_{AO}}{F_{TO}} \delta \quad (7.62)$$

For isothermal condition (i.e. $T = T_o$) with $\varepsilon=0$ [17], Equation 7.59 becomes

$$\frac{dy}{dW} = \frac{-\alpha}{2y} \quad (7.63)$$

where $y = \frac{P}{P_o}$ (dimensionless) and α is a constant ($\alpha=4$).

Full derivation of the pressure drop in packed bed reactors is provided by Fogler [17]. Table 7.12 shows the parameters of the differential pressure drop equation that is coupled with the differential equations for the conversions of A, B, C and D against the catalyst weight for four different catalysts.

The problem can be solved with the POLYMATH Simultaneous Differential Equation Solver using the following equations (Example 7-2.pol) and the parameters as shown in Table 7.12. Table 7.13 shows the results using POLYMATH program (Example 7-2.pol) and Figure 7.10 shows the plots of conversions of A, B, C and D, and pressure drop against catalyst weight for the different catalysts. Table 7.14 shows a process data sheet calculation of pressure drop in fixed catalyst beds

7.10 Increased ΔP

The pressure drop through a catalyst bed can be higher for a variety of reasons, namely [19]:

Breakage or Erosion of Catalyst Particles

Breakage of catalyst particles can result from incorrect charging of the catalyst or from different expansion and contraction between the catalyst and the containing vessel due to temperature cycling at start-up and shut-down. The breakage of catalyst particles gives a smaller particle diameter, while erosion of the corners of the particles gives a lower voidage due to the eroded particles packing more closely together.

Disintegration of Catalyst Particles

This can occur at the top of catalyst beds if the inlet gas distribution is poor and if the bed is not covered by a mesh or large particles of other material. When the inlet gas distribution is poor, high velocities will cause catalyst particles to be thrown around the space at the top of the vessel resulting in continuous erosion and disintegration. Powder from the disintegration of the particles will percolate through the catalyst bed, clogging spaces between other particles giving a low voidage and higher pressure drop.

Deformation of Catalyst Particles

If some catalysts become wet, especially in the reduced state, then the catalyst strength decreases, leading to deformation of the particles and reduced voidage that results in creased pressure drop across the catalyst bed.

Carry-over on to Catalyst Bed

Carry-over of dust in the gas streams will cause the spaces between particles to become blocked giving a high pressure drop.

Table 7.12 Parameters used in the POLYMATH program.

Ordinary Differential Equations (RKF45)	
1	$d(XA1)/d(W) = (k/FA0) \cdot (CA0 \cdot (1-XA1)^y)^2 / (1+KA \cdot CA0 \cdot (1-XA1)^y)$
2	$d(XA2)/d(W) = (k/FA0) \cdot (CA0 \cdot (1-XA2)^y)^2 / (1+KA \cdot CA0 \cdot (1-XA2)^y + KC \cdot CA0 \cdot XA2^y)$
3	$d(XA3)/d(W) = (k/FA0) \cdot (CA0 \cdot (1-XA3)^y)^2 / (1+KA \cdot CA0 \cdot (1-XA3)^y + KB \cdot CA0 \cdot (1-XA3)^y)^2$
4	$d(XA4)/d(W) = (k/FA0) \cdot (CA0 \cdot (1-XA4))^2 / (1+KA \cdot CA0 \cdot (1-XA4)^y + KB \cdot CA0 \cdot (1-XA4) + KC \cdot CA0 \cdot XA4^y)^2$
5	$d(y)/d(W) = -ALPHA / (2 \cdot y)$
Explicit equations as entered by the user	
1	ALPHA = 0.4
2	k = 10
3	FA0 = 1.5
4	CA0 = 1
5	KA = 1
6	KC = 20
7	KB = 2
Initial Conditions	
1	W(0) = 0
2	XA1(0) = 0
3	XA2(0) = 0
4	XA3(0) = 0
5	XA4(0) = 0
Final value:	
1	W(f) = 2

Table 7.13 Results of Example 7-2 using POLYMATH Program.

Calculated values of DEQ variables

	Variable	Initial value	Minimal value	Maximal value	Final value
1	ALPHA	0.4	0.4	0.4	0.4
2	CA0	1.	1.	1.	1.
3	FA0	1.5	1.5	1.5	1.5
4	k	10.	10.	10.	10.
5	KA	1.	1.	1.	1.
6	KB	2.	2.	2.	2.
7	KC	20.	20.	20.	20.
8	W	0	0	2.	2.
9	XA1	0	0	0.8625937	0.8625937
10	XA2	0	0	0.538934	0.538934
11	XA3	0	0	0.5353206	0.5353206
12	XA4	0	0	0.219375	0.219375
13	y	1.	0.4472136	1.	0.4472136

(Continued)

Differential equations

1	$d(XA1)/d(W) = (k/FA0) \cdot (CA0 \cdot (1-XA1) \cdot y)^2 / (1 + KA \cdot CA0 \cdot (1-XA1) \cdot y)$
2	$d(XA2)/d(W) = (k/FA0) \cdot (CA0 \cdot (1-XA2) \cdot y)^2 / (1 + KA \cdot CA0 \cdot (1-XA2) \cdot y + KC \cdot CA0 \cdot XA2 \cdot y)$
3	$d(XA3)/d(W) = (k/FA0) \cdot (CA0 \cdot (1-XA3) \cdot y)^2 / (1 + KA \cdot CA0 \cdot (1-XA3) \cdot y + KB \cdot CA0 \cdot (1-XA3) \cdot y^2)$
4	$d(XA4)/d(W) = (k/FA0) \cdot (CA0 \cdot (1-XA4) \cdot y)^2 / (1 + KA \cdot CA0 \cdot (1-XA4) \cdot y + KB \cdot CA0 \cdot (1-XA4) + KC \cdot CA0 \cdot XA4 \cdot y)^2$
5	$d(y)/d(W) = -ALPHA / (2 \cdot y)$
	pressure drop balance

Explicit equations

1	ALPHA = 0.4
2	k = 10
3	FA0 = 1.5
4	CA0 = 1
5	KA = 1
6	KC = 20
7	KB = 2

General

Total number of equations	12
Number of differential equations	5
Number of explicit equations	7
Elapsed time	1.157 sec
Solution method	RKF_45
Step size guess. h	0.000001
Truncation error tolerance. eps	0.000001

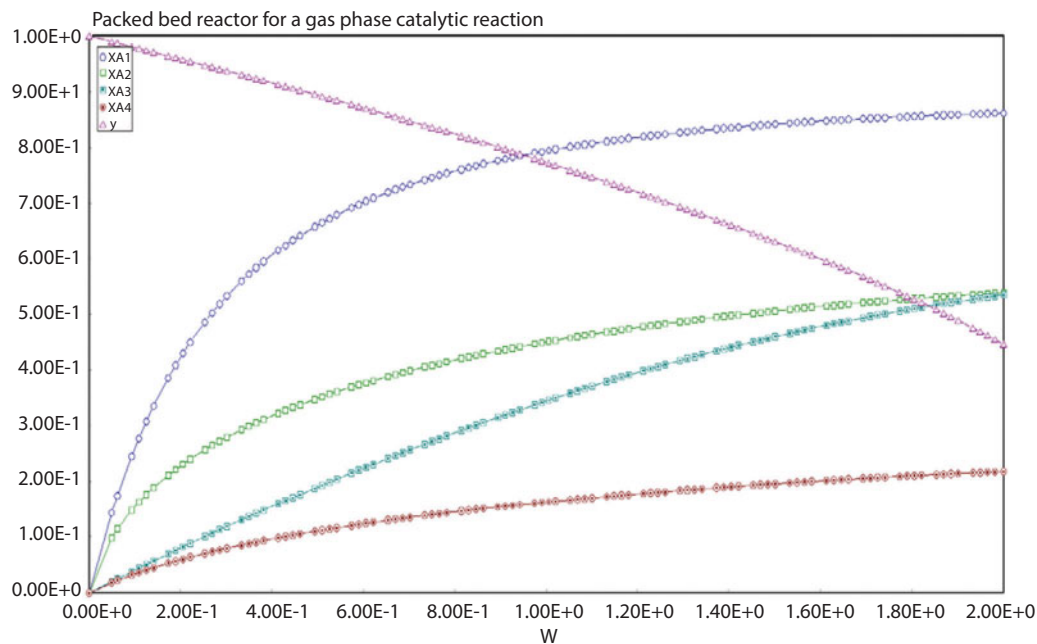


Figure 7.10 Profiles of Conversions and pressure drop against Catalyst weight.

Collapse of Bed Support

If there is a collapse of the bed support grid, or whatever device is used to hold catalyst away from the vessel exit nozzle, then the exit nozzle will be partly screened, causing a high pressure drop at the exit nozzle.

7.11 Factors Affecting Reaction Rate

Variables that affect reaction rate are:

- Process variables, e.g., weight average bed temperature (WABT), partial pressure of H₂, space velocity and gas rate
- Feed properties, e.g., nitrogen, aromaticity, True boiling point (TBP)
- Type of catalyst, poisoning, catalyst deactivation

The space velocity is:

$$\text{Space velocity} = \left(\frac{\text{Feed flow rate, m}^3/\text{h}}{\text{Catalyst, m}^3} \right) \quad (7.64)$$

In order to use the equation in designing cracking equipment, it is essential to assume that X represents the percentage of product that is produced. Figure 7.11 shows various definitions of the term X:

1. Hydrocarbons (ethane (C₂H₆) – heptane (C₇H₁₆)). The term X is used as mole (or gas volume) percentage and it refers to the disappearance of the feedstock hydrocarbon
2. Cracking stocks (naphtha – residuum). The term X is used as the liquid volume percentage of 400 E.P. gasoline that is produced.
3. High-boiling products (vacuum decomposition). The term X refers to liquid-volume percentage of various gravities of products obtained by the vacuum decomposition of asphalt or high-boiling feeds.

These distillates and lubricating oil products can only be determined at the sub-atmospheric pressure when decomposing higher-boiling materials than the products desired. Further, the pressures that apply to each of the lines on Figure 7.11 are the conventional pressures in conducting the processes. For ethane, propane and butane, the pressure is very low (0–50 psig). At high pressures (1500–2500 psig), the reaction rate constants of propane and isobutane are about 20 times

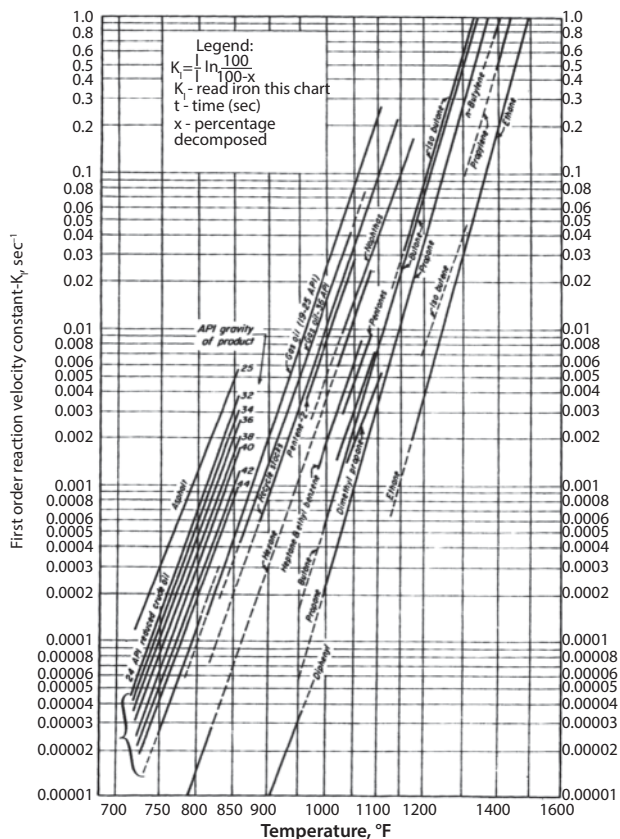


Figure 7.11 Reaction rate constants for the decomposition of hydrocarbons and petroleum fractions into various products (Source: W. L. Nelson, *Petroleum Refinery Engineering*, 4th ed., McGraw-Hill Series in Chemical Engineering, 1958).

greater than shown in Figure 7.11, and the constants for butane are 6–9 times greater.

Hydrocracking conversion can also be defined in terms of a change of the end point [1]:

$$\% \text{ Conversion} = \left[\frac{\left(EP^+ \right)_{\text{feed}} - \left(EP^+ \right)_{\text{products}}}{\left(EP^+ \right)_{\text{feed}}} \right] \times 100 \quad (7.65)$$

where EP⁺ is the fraction of material in the feed or product boiling above the desired end point usually as wt% or vol %.

There are several successive reactions in the hydrocracking of polyaromatics and naphthenes (Figure 7.12) and therefore, the detailed analysis of reaction kinetics can be complex, as different reaction rate constants indicate the relative reaction rate of each reaction.

The sequence of hydrogenation and cracking reactions in the hydrocracking of light catalytic cycle oil

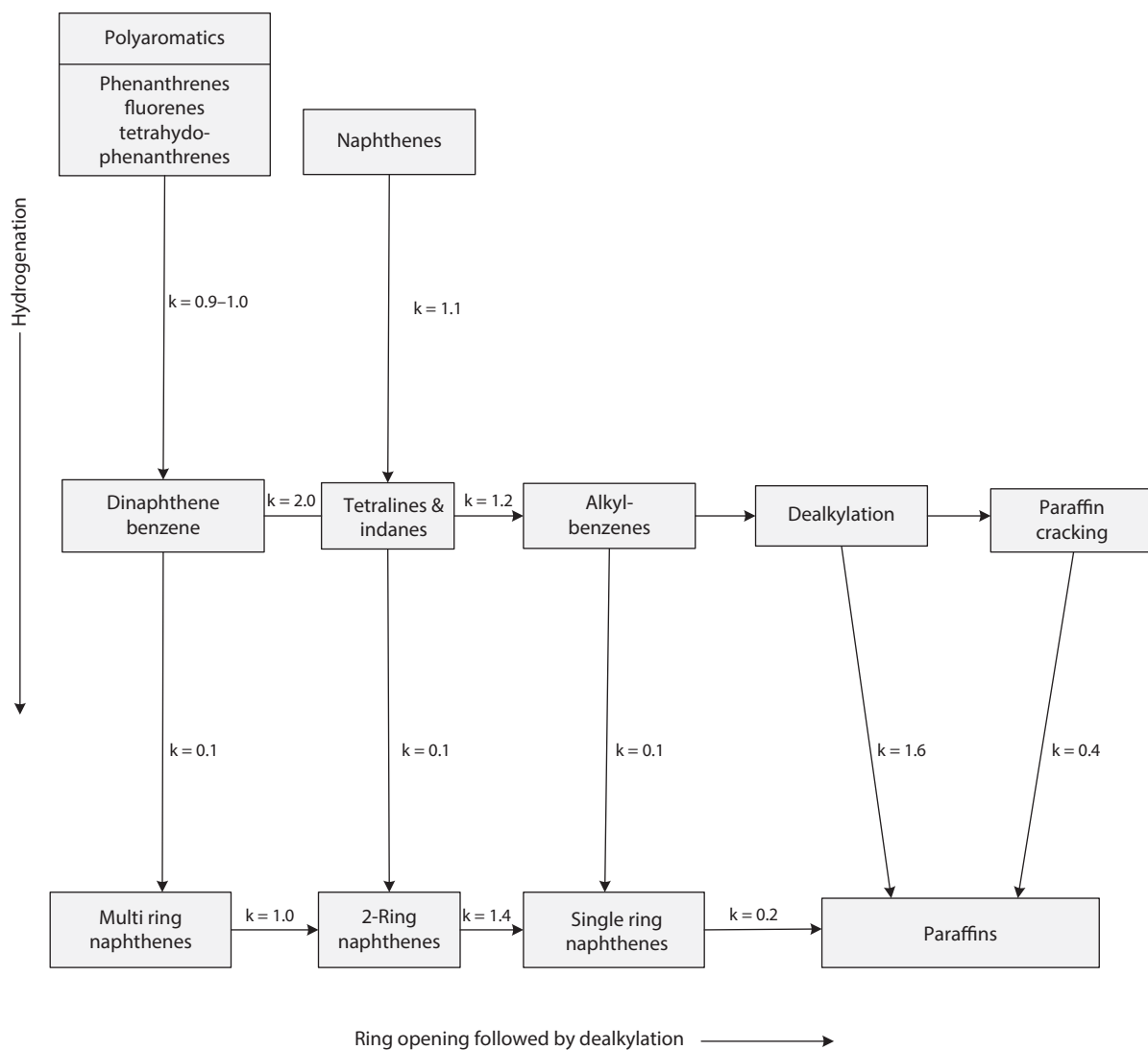


Figure 7.12 Relative rates of reactions under hydrocracking conditions (Source: Filimonov, A. V., *et al.* The rates of reaction of individual groups of hydrocarbons in hydrocracking, *Int. Chem. Eng.*, 12 (1), 7521, 1972.)

has been reviewed and the rate constants of the various reactions have been determined. The results in Figure 7.12 show that:

- Polycyclic aromatics are partially hydrogenated rapidly.
- Naphthene rings in polycyclic compounds are readily removed by ring-opening followed by cracking.
- Single-ring naphthenes and paraffins are more resistant to cracking.
- Single-ring aromatics are difficult to hydrogenate.

It was found that saturated compounds, particularly paraffins and single-ring naphthenes appear

to react more slowly at low feed conversions than at high conversion levels. This is because of the displacement of saturates from the catalyst by the strong adsorption of heavy aromatics initially present in the feedstock.

7.12 Measurement of Performance

The following measurement techniques are used to determine data for the evaluation of catalyst performance: analysis of inlet and exit gas, catalyst bed temperature rise, catalyst bed temperature profiles, radioactive tracing and pressure drop. These are discussed as follows [19]:

Analysis

Analysis of a gas stream from a reactor is normally the main source of information used to calculate the conversion within the reactor, and thus to determine the reactor performance. Analysis can be carried out by taking individual gas samples and analyzing them in a laboratory, by continuous analyzers on the plant or by passing a measured gas flow through a solution for a measured time, and analyzing this solution. Due to errors in such plant analyses, other techniques are usually also used to calculate the conversion in a reactor.

Mass Balance

In circulation loops, a mass balance around the loop and the circulation rate are used as checks on the conversion.

Catalyst-bed Temperature Rises

The temperature rise in a catalyst bed can be measured quite accurately by thermocouples at the inlet and exit of the bed, and thus enables an accurate calculation of the conversion of the reactor to be ascertained. This information can be used to check the analysis at either the inlet or the exit of the reactor.

Measurement of temperature gradients within catalyst beds is an important part of monitoring catalyst performance and is done using fixed thermocouples. However, it is also possible to use movable thermocouples within a sheath to provide an almost continuous measurement of temperature along the path of the thermosheath. Figure 7.13 shows different techniques of placing the thermocouple sheath in catalyst beds. The design of method A is favored over method B. Here, the thermosheath passes vertically through the bed, and advantages of the method are [19]:

1. There is only one entry into the vessel.
2. The risk to damage to the sheath inside the vessel during catalyst charging or discharging is less than in method B. The risk of damage on the outside of the vessel during routine maintenance is less than with method C.
3. The problem of the conduction of heat along the thermosheath is minimized compared with the other methods. This enables a truer indication of the temperatures in the reactor to be obtained.
4. A "traveling" thermocouple can be introduced into the sheath enabling very accurate monitoring of catalyst performance to be carried out. Having measurements in a single vertical

direction provides data more accurately interpreted than method B.

With this method, an air purge should be provided to remove water in the event of failure of the weather seal.

In method C, a series of relatively short thermosheaths pass horizontally into the catalyst bed. The principal advantages are [19]:

1. The position of the thermocouples is well defined, but it is unusual to be able to monitor the central regions of the bed.
2. There is less chance of rain water collecting in the bottom of the sheath due to failure of the weatherproof gland.
3. The thermosheath should normally extend into the vessel to within 40% of the center line. The arrangement permits ease of access for vessel maintenance and avoids measurement errors due to heat loss to the vessel wall. However, the top thermosheath should not be positioned too close to the top of the catalyst bed since normal settling and shrinkage could result in the duplication of the gas inlet temperature.

7.13 Catalyst-Bed Temperature Profiles

Catalyst-bed temperature profiles can be measured at regular intervals by passing a travelling thermocouple through a sheath in the bed and measuring the temperature at different points through the bed. Temperature profiles can be used directly to calculate the catalyst activity or the active volume of catalyst in the bed.

Radioactive Tracing

This technique is used to check whether there is poor distribution or by-passing in the reactor. A small amount of a radioactive species is injected upstream of the reactor and the radioactivity measured at the exit from the reactor. The decay of the level of radioactivity with time at the exit of the reactor is used to determine the residence time distribution in the reactor, and hence to establish whether by-passing is taking place [20].

Pressure Drop (ΔP)

If the pressure drop across a reactor is measured regularly, any increase of ΔP with time on-line can be monitored. The ΔP should always be measured by using the

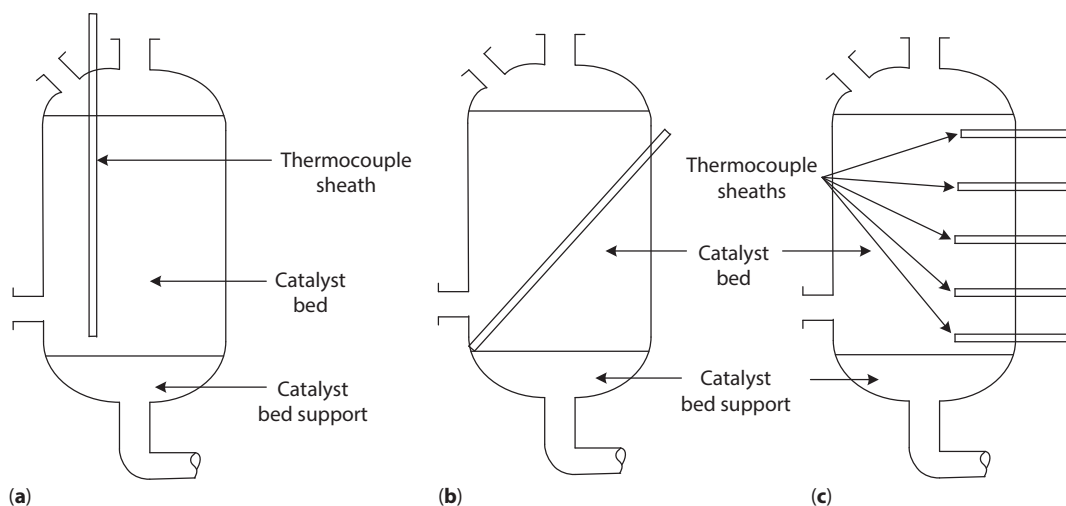


Figure 7.13 Possible arrangements of thermocouple sheaths in catalyst beds. (a) single vertical thermosheath; (b) single diagonal thermosheath; (c) multiple horizontal thermosheaths. Traveling thermocouples are often used in (a) and (b).

same pressure gauge on pressure tapplings at the inlet and exit of the reactor, or by connecting a differential pressure cell (DP cell) between pressure tapplings at the inlet and exit of the reactor.

7.14 Factors Affecting Hydrocracking Process Operation

The following factors can affect operation (product quality), yield (quantity) and the total economics:

- Process configuration: one stage (once-through or recycle) or two stages
- Catalyst type
- Operating condition (depends on process objective)
- Conversion level
- Maximization of certain product
- Product quality
- Catalyst cycle
- Partial hydrogen pressure
- Liquid hourly space velocity
- Feed/hydrogen recycle ratio

7.15 Hydrocracking Correlations

Yield Correlations

This correlation in conventional hydrocracking depends upon the feed properties, hydrogen severity and type of operation. There are three types of operation: maximum

gasoline, maximum Aviation Turbine Kerosene (ATK) (jet fuel) and maximum diesel fuel. In all of these types, gasoline yield is used to correlate the other yields. Using mild hydrocracking (low severity) will add a fourth type of operation, maximum low sulfur fuel oil (LSFO). The hydrogen severity ranges between 1.5–4 wt % of feed. In mild hydrocracking, it is assumed 1.5 wt % and in conventional hydrocracking as 3.0 wt %. In high severity (high aromatic feeds), it is assumed as 4.0 wt % of feed. ATK type is frequently used because of the high demand for aviation fuels, and Table 7.15 shows typical hydrocracking yields.

The yields from the hydrocracker are dependent upon the type of crude oil, operating conditions, previous processing operations and type and activity of catalyst used. The yields for hydrocracking to produce gasoline as the primary product can be determined from charts and equations developed by Nelson [2, 6, 7]. The data required to start the calculations are the Watson characterization factor (K_w) of the feed and the hydrogen consumption in scf/bbl feed. The calculations are as follows:

1. Use Figure 7.14 to determine the vol % (C_{5-} 180 °F) naphtha.
2. With Figure 7.15, use the vol % (C_{5-} 180 °F) naphtha and feed K_w to obtain vol% (180–400 °F) naphtha.
3. Calculate the liquid vol % butanes formed using;

$$\text{LV \% } iC_4 = 0.377 [\text{LV \% } (C_{5-} \text{ 180 } ^\circ\text{F})]$$

$$\text{LV \% } nC_4 = 0.186 [\text{LV \% } (C_{5-} \text{ 180 } ^\circ\text{F})]$$
4. Calculate the wt % propane and lighter using:

$$\text{wt\% } C_3 \text{ and lighter} = 1.0 + 0.09 [\text{LV \% } (C_{5-} \text{ 180 } ^\circ\text{F})]$$

Weight and hydrogen balances are made on the unit, and the gravities of the product streams can be calculated using the K_w factors of the product streams obtained from Figure 7.15 and average mid-boiling

Table 7.15 Hydrocracking Yields [5].

	Naphtha	Jet	Diesel
Yields on coker gas oil and FCC decanted oil (vol% on feed)			
Butanes	17	8	5
C ₅ -180 °F	32	15	9
180-380 °F	81	24	20
Jet or diesel	-	74	84
Total	130	121	118
Yields on coker gas oil and FCC decanted oil (vol% on feed)			
Butanes		5.2	
C ₅ -180 °F		8.8	
180-435 °F		31.8	
435-650 °F, diesel		33.8	
650 °F+, gas oil		35.0	
Total		114.6	

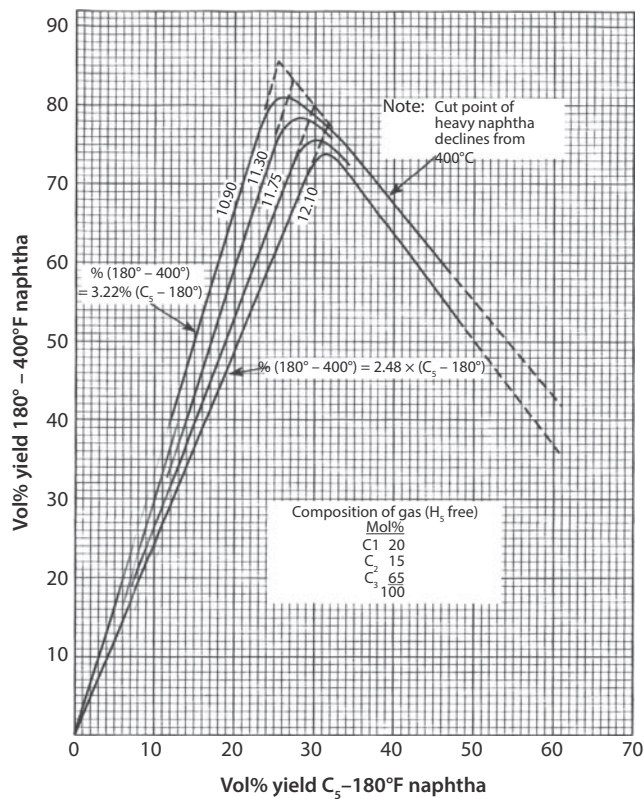


Figure 7.14 Relationship between yields of C₅-180 °F and 180-400 °F hydrocrackates (Source: Gary James H., et al., *Petroleum Refining - Technology and Economics*, 5th ed., CRC Press, Taylor & Francis Group, 2007).

points of 131, 281 and 460 °F for the C₅-180 °F naphtha, 180-400 °F naphtha and 400+ °F streams respectively. The weight of the 400+ °F stream is obtained by difference. The chemical hydrogen consumed should be included with the total weight of the feed.

Hydrogen contents of the streams can be estimated using the wt% hydrogen for each stream, except the heavy hydrocrackate (180-400 °F) obtained from Figure 7.16 [8]. The heavy hydrocrackate is highly naphthenic and contains from 13.3-14.5 wt % hydrogen (avg. 13.9%). Assume that hydrogen loss by solution in the products of 1 lb/bbl feed (range 0.8-1.3 lb H₂/bbl feed [9]). If the yield of C₅-180 °F naphtha is greater than 25-30 vol%, the yield of heavy hydrocrackate (180-400 °F naphtha) will be determined from a curve having a negative slope. This indicates an economically unattractive case because heavy hydrocrackate is being cracked to lighter materials and therefore a less severe operation should be applied.

In general, hydrocracking yields are increased by:

- High temperature
- High pressure
- Low space velocity

In order to obtain high product quality and yields, it is necessary to carefully control the hydrocracking and aromatization reactions. Reactor temperatures are also carefully monitored to observe the extent of each of these reactions.

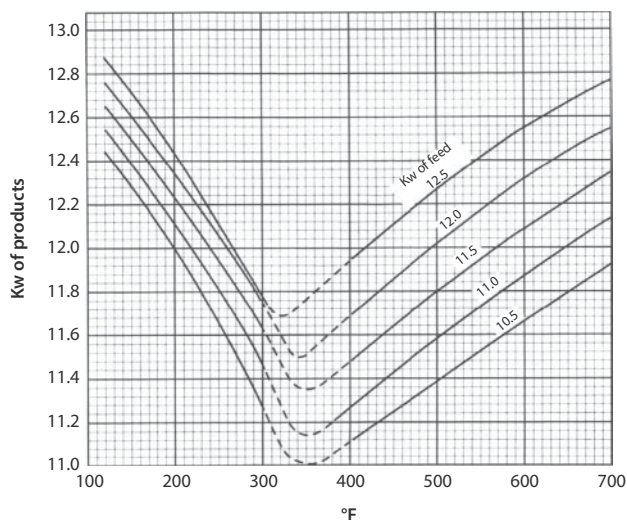


Figure 7.15 Characterization factor of hydrocracker products (Source: Gary James H., et al., *Petroleum Refining - Technology and Economics*, 5th ed., CRC Press, Taylor & Francis Group, 2007).

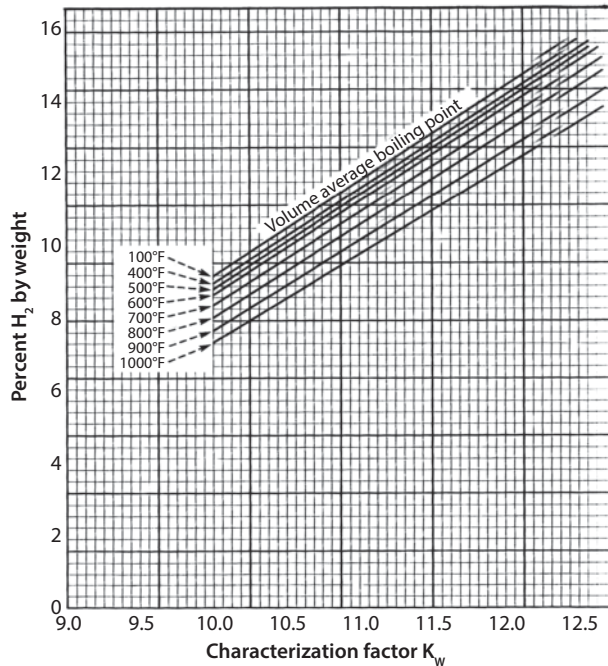


Figure 7.16 Hydrogen content of hydrocarbons (Source: Gary James H., et al., *Petroleum Refining – Technology and Economics*, 5th ed., CRC Press, Taylor & Francis Group, 2007).

7.15.1 Maximum Aviation Turbine Kerosene (ATK) Correlations

The ATK mode yield correlations are developed from plant data and are provided as an example:

Hydrocracking severity H where

$$H \text{ wt \%} = \frac{\text{lb. Hydrogen}}{\text{lb of feed}} \times 100$$

For maximum ATK, assume H = 3 wt %

$$\text{In this case, } V_H = \frac{\text{thousands of ft}^3 \text{ hydrogen}}{\text{bbl of feed}}$$

And is related to hydrocracking severity as:

$$V_H = 0.6621 \times H \times \text{SpGr}$$

Calculate liquid volume % (LV %) of gasoline

$$\text{Gasoline LV \%} = -0.03734 \text{ API}_f^2 + 1.57575 \text{ API}_f + 0.014923 K_w - 1.36473 V_H - 0.16324 V_H / K_w$$

$$\text{where } K_w = \frac{T_B^{1/3}}{\text{SpGr}}$$

Butanes (iC₄ and nC₄)

$$\text{C}_4 \text{ LV \%} = 0.020359 (\text{LV \% Gasoline})^2 + 0.04888 (\text{LV \% Gasoline}) + 0.108964 \text{ API}_f$$

Heavy naphtha (HN) (180–380 °F) [82–193 °C]

$$\text{HN LV \%} = -0.10322 (\text{LV \% Gasoline})^2 + 2.981215 (\text{LV \% Gasoline}) - 0.07898 \text{ API}_f$$

ATK

Calculated by mass difference between feed and products

The following equation is used to convert LV% to wt% hydrocarbon products

$$\text{Product wt \%} = 0.8672 \times \text{Product LV \%} - 0.9969$$

Example 7-3

A feed of VGO of 40,000 BPCD is hydrocracked to maximize the ATK production. The API of the feed is 25 and the mean average boiling point TB = 580 °F. Make the material balance around the hydrocracker.

Solution

Example 7-3.xlsx shows the Excel spreadsheet of Example 7-3, and the following calculations of the mass balance are as follows:

The specific gravity from API is:

$$^\circ \text{API} = \frac{141.5}{\text{SpGr}} - 131.5$$

$$\text{SpGr} = \frac{141.5}{(^\circ \text{API} + 131.5)} = \frac{141.5}{(25 + 131.5)} = 0.904$$

Assume H = 3 wt%, then

$$V_H = 0.6621 \times 3 \times 0.904 = 1.796 \text{ ft}^3/\text{bbl}$$

$$K_w = \frac{T_B^{1/3}}{\text{SpGr}} = \frac{(580 + 460)^{1/3}}{0.904} = 11.21$$

$$\begin{aligned} \text{Gasoline LV \%} &= -0.03734 \text{ API}_f^2 + 1.57575 \text{ API}_f + 0.014923 K_w - 1.36473 V_H - 0.16324 \\ &\quad V_H / K_w \\ &= -0.03734 (25)^2 + 1.57575 (25) + 0.014923 \times 11.21 - 1.36473 \times 1.796 \\ &\quad - 0.16324 (1.796/11.21) = 13.746 \end{aligned}$$

$$\text{Gasoline wt \%} = 0.8672 \times 13.746 - 0.9969 = 11.82$$

Butanes (iC₄ and nC₄)

$$\text{C}_4 \text{ LV \%} = 0.020359 (\text{LV \% Gasoline}) + 0.04888 (\text{LV \% Gasoline}) + 0.108964 \text{ API}_f$$

$$= 0.020359 (13.746)^2 + 0.04888 (13.746) + 0.108964 (25)$$

$$= 7.24$$

$$C_4 \text{ wt \%} = 0.8672 \times 7.24 - 0.9969$$

$$= 5.28$$

$$\text{HN LV\%} = -0.10322 (\text{LV\% Gasoline})^2 + 2.981215 (\text{LV\% Gasoline}) - 0.07898 \text{API}_f$$

$$= -0.10322 (13.746)^2 + 2.981215 \times 13.746 - 0.07898 \times 25$$

$$= 19.50$$

$$\text{HN wt \%} = 0.8672 \times 19.50 - 0.9969$$

$$= 15.91$$

$$\text{ATK wt \%} = 100 + 3 - 11.82 - 5.28 - 15.91$$

$$= 69.99$$

Material balance summary:

Feed	VGO	100
	Hydrogen	3
	Total	103
Products	C ₄	5.28
	Gasoline (C ₅ -180 °F)	11.82
	HN (180-400 °F)	15.91
	ATK (+ 400 °F)	69.99
	Total	103.0

7.15.2 Process Description

Figure 7.17 shows a typical hydrocracking process flow diagram. The gas oil feed is combined with recycle hydrogen heated by exchange with the reactor product via a furnace and fed to a reactor bed. The net heat of reaction is exothermic, and the reacted mixture is cooled by quenching with hydrogen into the reactor beds before entering the second reactor bed, as this is to control the reactor temperature.

The resultant product from the second reactor bed is cooled by exchange with the feed and sent to a series of separators where the liquid products are removed from the unreacted hydrogen and light gases. A water wash is used to remove some of the impurities from the hydrogen recycle stream. An amine treating process removes any remaining ammonia (NH₃) and hydrogen sulfide (H₂S) from the recycle gas prior to recirculation to the process. Fresh hydrogen is added to the system as required to replace the hydrogen consumed in the reaction and to maintain a desired level of hydrogen in the recycle gas. Depending on the process and the feedstock, there may also be a hydrotreating reactor prior to the hydrocracking reactor (s) to remove catalyst poisons and improve the product distribution and catalyst life for the hydrocracking reactor(s).

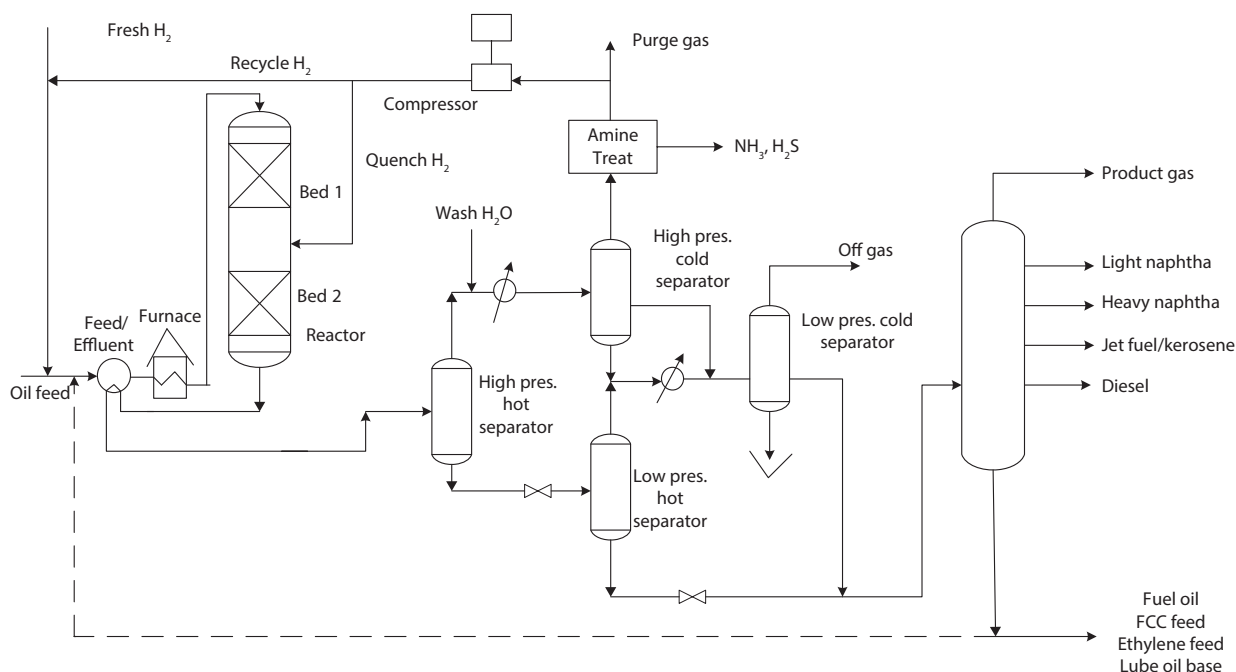


Figure 7.17 Flow diagram of a hydrocracking process with and without recycle.

The reactors are fixed beds of catalyst that must be taken off-line periodically for regeneration of the catalyst and/or replacement. The run cycle is dependent on the feedstock being processed and the severity of the operating conditions. Catalysts are often regenerated several times before replacement is due.

The cracking feedstocks are diesel fuel, atmospheric and vacuum gas oils, FCC cycle oils, coker cycle oils and residual oils. These stocks contain higher concentrations of unsaturated compounds than virgin products and have higher consumptions of hydrogen in the reactor. An essential reaction in the hydrocracker is the hydrogen saturation and conversion of aromatic rings into naphthene rings that may be cracked. Aromatic rings are very stable and cannot be cracked with standard catalytic cracking processes.

Hydrogen saturation of olefins (C_nH_{2n} , $n = 2, 3, 4$ etc.) and aromatics (C_nH_{2n-6} , $n = 6, 7, 8$, etc.) results in a substantial volumetric increase and liquid volume gains of up to 25%. This process also produces less propane (C_3H_8) and dry gas than other cracking processes. Saturation of feed olefins and olefins produced by cracking is very rapid and complete. Furthermore, significant saturation of aromatic rings may be accomplished depending upon the feedstock and the operating severity.

Feed olefins and olefins created in the reactor are rapidly saturated in the high hydrogen atmosphere. Isomerization is also favored in the reactor, and high-octane isoparaffins are present in the reactor product. Condensed aromatic rings are also saturated to cycloparaffins that may be cracked to smaller molecules. Hydrogen sulfide (H_2S) tends to inhibit the saturation of aromatic rings; this conserves hydrogen and produces a gasoline of higher octane than straight naphthenic gasoline.

The reactor operating pressures vary from 1000 - 2000 psig (70 - 139 bar), depending on the process and the feedstock. Temperatures are in the range of 600–850 °F (316–445 °C), which are controlled between reaction beds with quench hydrogen. Hydrogen consumption is dependent on the feedstock being cracked and the severity of the operating conditions. It varies from 500–3000 SCF/barrel charge (89–534 scm/m³).

In a single stage, without liquid recycle, the conversion can be optimized between 60–90%. The very paraffinic residue is used to make lubricant oil bases of high viscosity index within the range of 150 N to 350 N; the residue can be used as feedstock to steam cracking units to produce ethylene and propylene yields equal to those of paraffinic naphthas or as additional feedstock to catalytic cracking units.

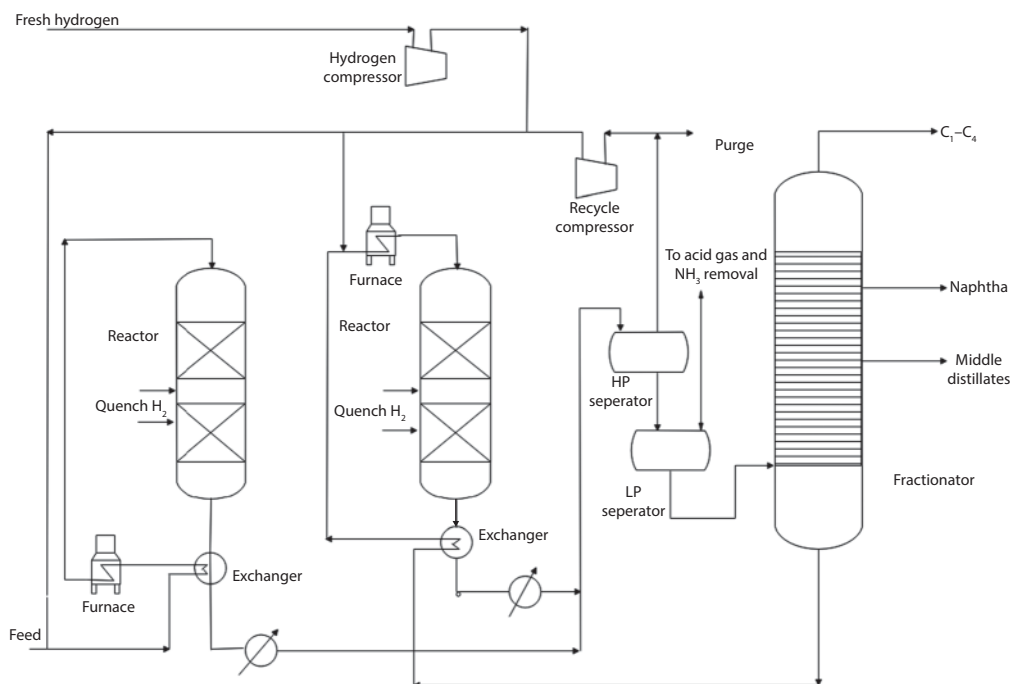


Figure 7.18 Two-stage hydrocracking process.

Figure 7.18 shows a typical hydrocracking process where the feed is mixed with recycled and fresh hydrogen. The first stage cracking is carried out in the first reactor and the products are sent to separators to separate the unreacted hydrogen. The separated liquid is distilled in a fractionator which produces $C_1 - C_4$ gases at the top, naphtha and middle distillates as side draws. The bottoms are heated and sent to the second hydrocracker reactor whose cracked products are also mixed with those of the first reactor. In both of these configurations, the hydrogen is separated in the high pressure separator and recycled back to the reactor. The hydrocracking catalyst in the first stage has a high hydrogenation/acidity ratio causing sulfur and nitrogen removal. In the second reactor, the catalyst used is of a low hydrogenation/acidity ratio in which naphtha production is maximized. The main reactions occurring in each reactor are depicted in Figure 7.19. Maximizing the side draws such as the middle distillate, kerosene and diesel and jet fuel requires a high hydrogenation/acidity ratio, and a hydrotreatment reactor may be added before the first hydrocracker to help in removing sulfur, and nitrogen compounds from the feed (Figure 7.20). Since the sour gases (H_2S and NH_3) are separated before entering the second reactor,

special catalysts can be selected in the reactor without the poisoning effect of the sour gases, which invariably allow greater conversion. The two-stage configuration is more flexible than the single stage, and it is better adaptable to heavy feedstocks.

There are two levels of hydrocracking severity: conventional and mild. In mild hydrocracking, the process proceeds as less severe operating conditions similar to hydrotreating (i.e., desulfurization) conditions. A comparison of hydrotreating, conventional hydrocracking and mild hydrocracking operating conditions are shown in Table 7.16. A one-stage reactor without recycle is used in the mild hydrocracking process as the major characteristics are the production of a high yield of fuel oil and a savings of hydrogen. The process operates at nearly half of the consumption of hydrogen as compared with the conventional process. Figure 7.21 shows a comparison of the products in each of these processes.

Figure 7.22 is a block diagram of a hydrocracking process with other processes, and Figure 7.23 illustrates the description of the hydrocracking process of this facility. Here, the hydrocracker unit processes a waxy distillate from a high-vacuum unit to produce lighter distillates and fuel gas. The hydrocracker uses a

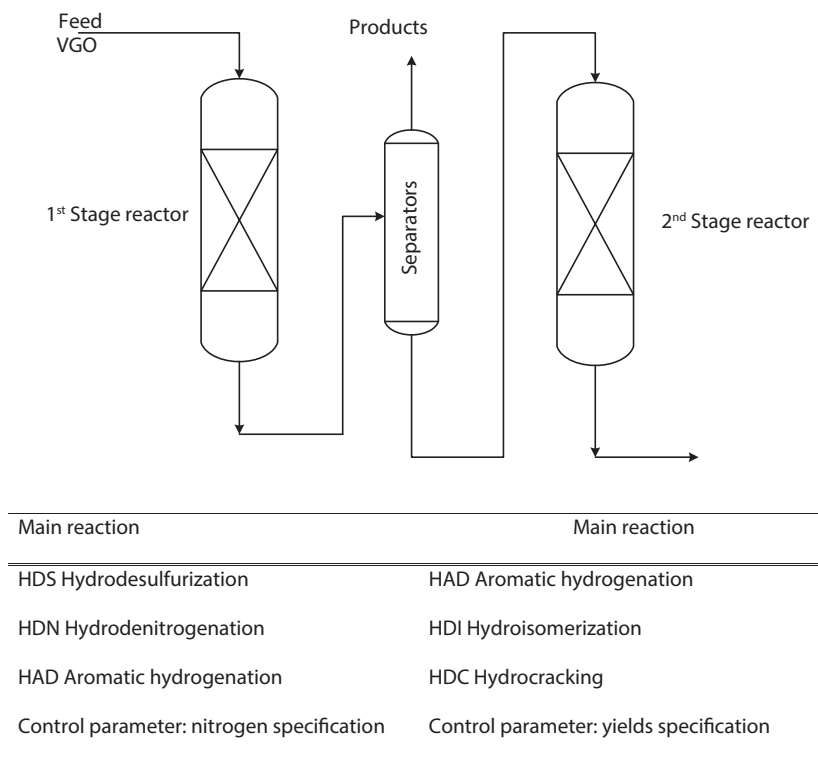


Figure 7.19 Main reactions in the two-stage hydrocracking process.

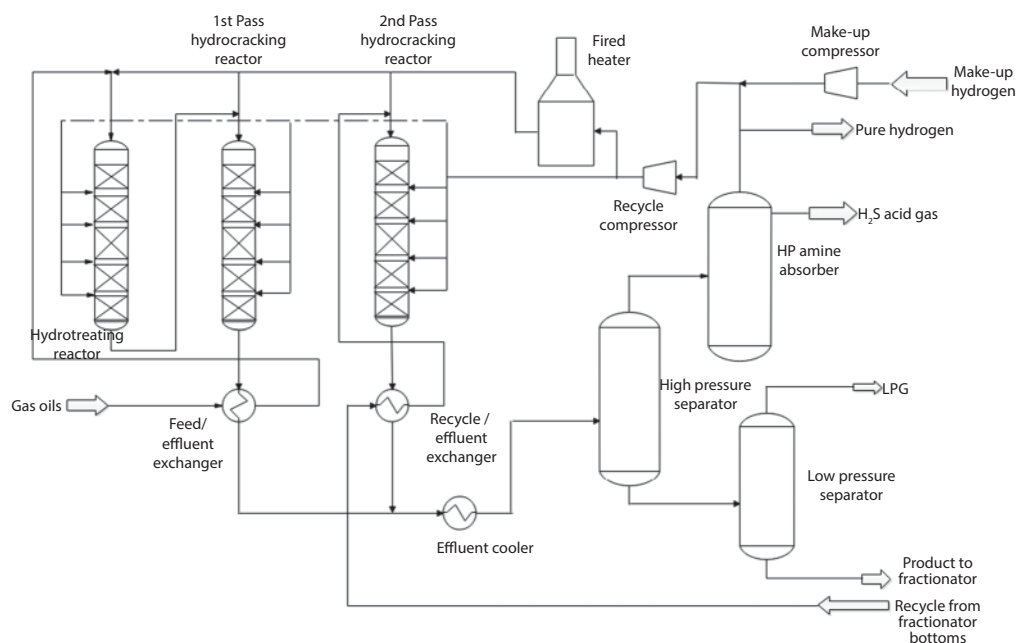


Figure 7.20 Schematic of the two-stage hydrocracking process with a hydrotreating reactor.

Table 7.16 Comparison of operating conditions of mild hydrocracking, conventional hydrocracking and hydrotreating processes [3].

Operating conditions	Mild hydrocracking	Conventional hydrocracking	Hydrotreating
Conversion (%)	20–70	70–100	–
H ₂ pressure, bar	35–70	85–140	25–50
H ₂ flow (l/min)	300–1000	1000–2000	300
Temperature, °C	350–440	350–450	360–400
LHSV (h ⁻¹)	0.3–1.5	0.5–2.0	0.5–2.5
Catalyst			
Hydrogen transfer	Ni/Mo	Ni/Mo	Co/Mo
(Metal)	Co/Mo	Ni/W Pd	Ni/Mo
Support	Alumina	Si - Al	Alumina
Cracking (acid)	Si - Al	Zeolite	

two-stage reactor system lined up in a series flow-type operation. Due to capacity, two reactor trains operating in parallel are required to optimize equipment size. The process consumes hydrogen, which is supplied by the hydrogen manufacturing unit (HMU).

The hydrocracking catalyst is sensitive to the presence of organically bonded nitrogen compounds in the feed. The objective of the first reaction stage is to obtain nitrogen-free hydrocarbons as feed to the second reactor. Desulfurization, denitrification, together with hydrogenation and some hydrocracking reactions

take place in the first reactor, consuming hydrogen and yielding hydrogen sulfide (H₂S), ammonia (NH₃) and cracked products. The resultant stream is reduced in aromatic content. The catalyst employed in this case is a fluorided nickel/molybdenum formulation on an alumina carrier.

The major hydrocracking reaction takes place in the second-stage reactor. More hydrogen is consumed and light products are formed. The catalyst used in this reactor is a nickel/tungsten formulation on a zeolite carrier.

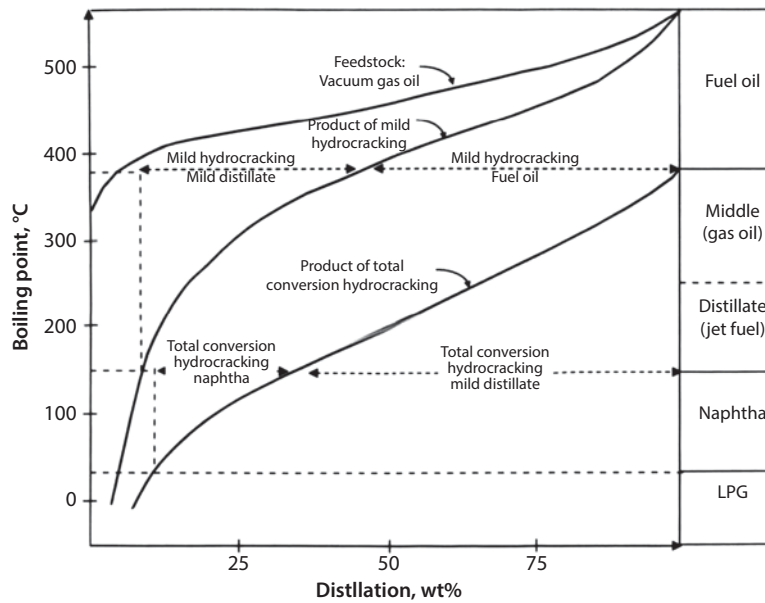


Figure 7.21 Comparison of products obtained by mild and conventional hydrocracker (Source: Secherzer, J., and A. J. Gruia, *Hydrocracking Science and Technology*, Marcel Dekker, New York, 1996).

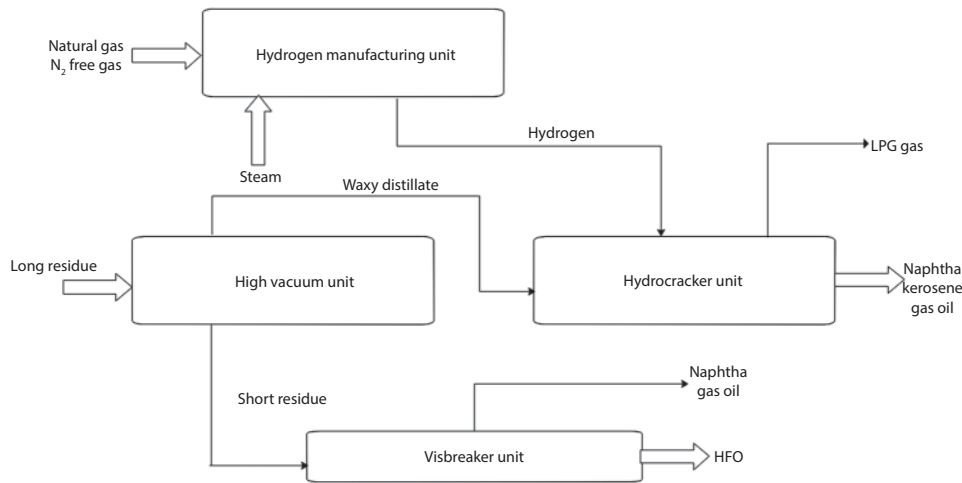


Figure 7.22 A schematic block diagram of hydrocracking unit with other processing units.

The hydrocracker reactor unit comprises several sections, which have been grouped to form the following main systems:

1. Fresh feed and recycle liquid system.
2. Reactor trains.
3. Liquid and vapor separation.
4. Water wash separation.
5. Recycle gas compression and distribution.
6. Hydrogen distribution.
7. Control of the hydrogen system.

7.15.3 Fresh Feed and Recycle Liquid System

Hot feed from the high-vacuum unit enters feed surge vessel controlled by a level controller. The entering feed passes through the catalyst filled filter to remove solid particles. The feed is then pumped to the first-stage reactors via feed preheat exchangers. The controls of the fresh feed pump minimize the power consumption while fulfilling process requirements. The unconverted feedstock from the bottom of the mild vacuum column of the hydrocracker fractionation unit is recycled

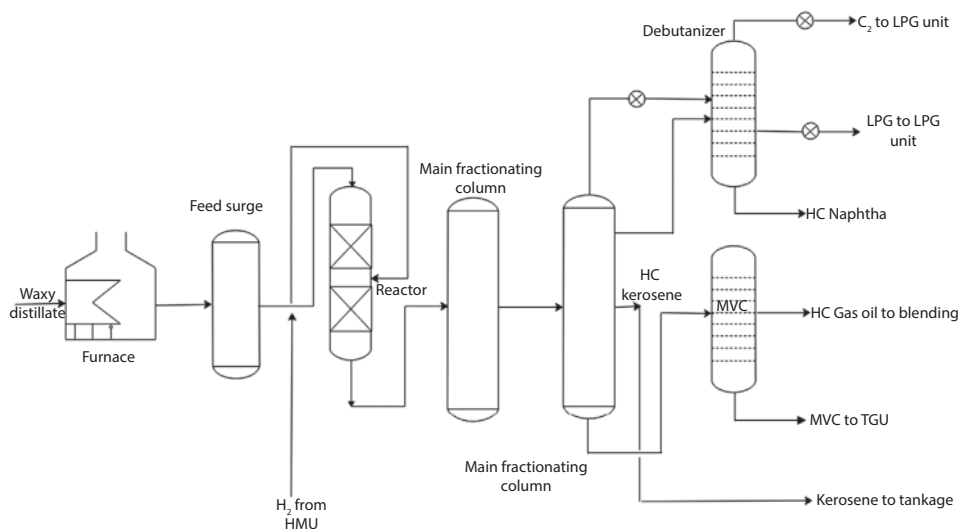


Figure 7.23 Process flow diagram of hydrocracking unit of a facility.

to second-stage reactors. The recycle liquid enters the catalyst filled filter before it enters the liquid recycle surge vessel.

Reactor Trains

The reactor trains consist of first-stage reactors, second-stage reactors, reactor effluent heat exchangers and air coolers. Various streams are used as the cooling medium in the series of effluent heat exchangers.

The fresh feed stream is split and flows to the first-stage reactors via effluent heat exchangers. The preheated feed is then mixed with recycle gas at the inlet of the first-stage reactors. To achieve the required denitrification (10 ppmw), the temperature of the mixture is controlled, which adjusts the recycle gas temperature prior to the mixing. The mixture then enters the first of the four catalyst beds in the first-stage reactor.

The reactions that occur in the catalyst beds are highly exothermic and to limit the temperature rise, cold recycle gas is introduced between the beds as a quench. The amount of quench gas added upstream of catalyst beds is regulated by temperature controllers. The quench gas is provided to limit the temperature rise over each bed to 77 °F (25 °C) over the first two beds and 68 °F (20 °C) over the remaining beds.

The first-stage reactor effluent is cooled by heat exchange with fresh feed, and the recycle is added to the effluent after the heat exchanger. The combined, effluent and liquid recycle is mixed with recycle gas at the inlet of the second-stage reactor. The mixture then enters the first catalyst bed of the second-stage reactor.

The major hydrocracking reactions take place in a series of fixed catalyst beds in the second-stage reactor. These reactions are also exothermic, and therefore, cold recycle gas is introduced between the catalyst beds to control the temperature as in the first reactor. The amount of quench gas added upstream of catalyst beds is regulated by the temperature controllers; the quench is provided to limit the temperature rise over the beds to 50 °F (10 °C) per bed.

The effluent from the second-stage reactor is cooled by heat exchange with fresh feed as described earlier. Additional heat recovery is obtained by preheating the fractionator feed with heat exchangers and are used to preheat the recycle gas. The tube wall temperatures in the reactor effluent side of the heat exchangers must be kept above 302 °F (150 °C) to prevent sublimation and deposition of fluorine salts. A bypass of fresh feed from the feed/effluent exchangers is provided to ensure that this precaution is achieved. Wash water is injected upstream of the air coolers to prevent corrosion and plugging by the deposition of salts as the reactor effluent is cooled. This injection is primarily for the safe operation of the unit and must be maintained over the entire length of the run. The wash water is then cooled and free of oxygen; the parallel effluent streams are combined to form a single stream.

7.15.4 Liquid and Vapor Separators

The reactor effluent downstream consists of a mixture of gas, oil, and water phases. High-pressure separator allows the phases to disengage and to separate. The

top of the separator serves as a knock-out drum, of the recycle gas compressor.

The oil phase in the high-pressure separator is released to low-pressure separator by a level controller where it is flashed. The off-gas produced is sent to an aqueous diisopropanolamine (ADIP) treatment unit for H_2S recovery. Pressure is maintained in the low-pressure separator by a controller; the oil-phase from the low-pressure separator is on a level control, and is pumped via a coalescer feed pump, coalescer feed filter and fractionator feed coalescer. The pump boosts the pressure to overcome the system pressure drop and to prevent flashing in the coalescer. The coalescer removes free water, which is drained to the low-pressure separator or to sour water flash vessel. The oil is then used to cool the reactor effluent as described earlier. The flow splits upstream of the exchanger, and exchanges heat with the reactor effluent in each train and then flows to the hydrocracker fractionation unit.

Wash Water System

A water circuit is used in the separator section to dissolve ammonia salts, which can deposit in the cooler parts of the plant. H_2S and NH_3 produced in the reactors together with fluorine stripped from the catalyst, combine to form the salts, which can cause corrosion. Wash water is injected at appropriate points to dissolve these salts, thus reducing corrosion and avoiding plugging. The water phase from the high-pressure separator flows to sour water flash vessel. The off-gas is sent to the ADIP treating unit for H_2S recovery. The flash vessel contains baffles of skim oil off the sour water. Both the skimmed oil and sour water are sent to sour water stripper for transfer to slops and further treating respectively.

7.15.5 Recycle Gas Compression and Distribution

The gas from the top of the high-pressure separator is circulated through the reactor trains by the recycle gas compressor. The make-up hydrogen is connected with the recycle gas at the discharge of the gas compressor, and then flows to the two reactor trains. The distribution of gas is the same in each train. The recycle gas compressor is a turbine-driven centrifugal compressor equipped with lube oil, seal oil, control oil systems and an alternate external buffer gas supply. The bulk of the recycled gas is preheated by heat exchange with the reactor effluent. The quench gas bypasses the heat

exchanger, and is injected into the reactors, as required to limit the temperature increase through the various catalyst beds. A second bypass delivers unheated recycle gas to each of the furnaces to maintain operating flexibility in the firing of the furnaces. The amount of bypass to each furnace is manually adjusted.

The recycled gas from the furnace in the second-stage reactor heats the remainder of the recycled gas to the proper temperature for hydrocracking. The cooled reactor effluent is then returned to the high-pressure separator to complete the recycled gas flow cycle. The process temperatures in the furnace are extremely high so that there is a large amount of useful heat in the flue gas. Some of this heat is recovered by generating high-pressure, superheated steam in common waste heat boiler. The steam is sent to the refinery high-pressure steam system.

7.15.6 Hydrogen Distribution

The hydrogen-rich make-up gas is supplied by the hydrogen manufacturing unit (HMU). The make-up gas allows for the chemical consumption of hydrogen, leakage, and solution losses. The make-up gas is sent to fresh gas compressors, where each compressor supplies 50% of design requirements that are normally in operation and a spare on standby.

The fresh gas compressors are the central distribution points of the hydrogen supply and control system. Since the hydrocracker is the largest consumer of hydrogen, the system is handled as part of the hydrocracker reactor. Other hydrogen consumers are the hydrodealkylation, hydrodesulfurization and ultra low-sulfur diesel (ULSD) and platformer hydrotreater units.

High-purity feed hydrogen enhances the operation of gas oil desulfurization unit. The hydrogen header pressure is controlled by a pressure controller in the supply line to the kerosene hydrodesulfurization unit. The hydrogen production from the platformer unit also supplies the hydrogen header. The gas is fed to booster compressors and compressed into the header. The remaining H_2 consumers are supplied with the gas from the H_2 header.

7.15.7 Control of the Hydrogen System

The hydrogen manufacturing unit (HMU) is capable of producing more hydrogen than all of the process units can consume. The excess hydrogen is discharged

into the refinery fuel gas system under pressure control. The maximum flow through the let down control valve occurs when the hydrocracker is shut down, and the hydrogen manufacturing unit is operating at 40% capacity. The recycle of hydrogen production to the hydrogen manufacturing unit fuel gas is then at a maximum. The refinery fuel gas system can absorb the hydrogen-rich gas without disturbing the burner operation. Additional excess gas is then flared.

7.15.8 Reactor Design

Fixed-bed reactors are used for hydrocracking, hydro-treating, isomerization and catalytic cracking reforming. The reactors have an internal refractory lining that insulates the shell from the high reaction temperatures and thereby reduces the required metal thickness. The metal parts exposed to the high-temperature hydrogen atmosphere are constructed from steel containing at least 5% chromium (Cr) and 0.5% molybdenum (Mo) to resist hydrogen embrittlement. Proper distribution of the inlet vapor is required to make maximum use of the available catalyst volume. Some reactor designs provide for radial vapor flow rather than the simpler straight-through type as shown in Figure 7.24. The important feature of vapor distribution is to provide maximum contact time with minimum pressure drop.

Temperature measurement at a minimum of three elevations in the catalyst bed is considered necessary to determine catalyst activity and helps in coke burn-off operation. The catalyst pellets are generally supported on a bed of ceramic spheres about 12–16 in. (300–400 mm) deep. The spheres vary in size from about 1

in. (25 mm) on the bottom to about 0.35 in. (9 mm) on the top.

Catalyst Loading of the Fixed-Bed Reactors

Typical fixed-bed catalyst loading in the two hydrocracker reactors and design operating parameters are:

1 st Stage Hydrocracking reactor	
Design pressure, bar	157
Design temperature, °C	435
Internal diameter (ID), mm	3300
Overall length, mm	27,850
Number of beds	4
Catalyst volume, m ³	139
Materials of construction	
Internals	321 Stainless steel
Reactor	321 Stainless steel cladding

2 nd Stage Hydrocracking reactor	
Design pressure, bar	157
Design temperature, °C	435
Internal diameter (ID), mm	
Overall length, mm	32,550
Number of beds	6
Catalyst volume, m ³	162
Materials of construction	
Internals	321 Stainless steel
Reactor	321 Stainless steel cladding

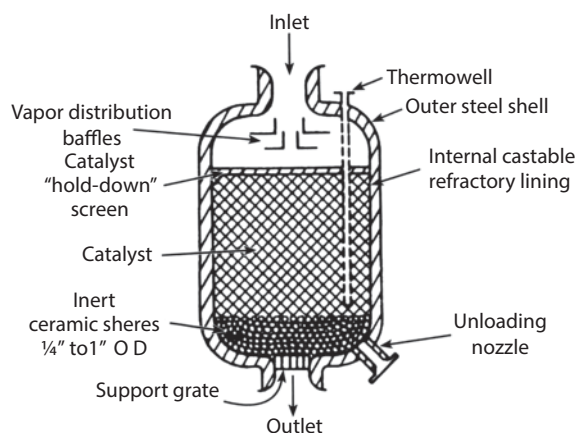


Figure 7.24 Typical fixed-bed downflow catalytic reactor (Source: Gary, James H., et al., *Petroleum Refining Technology and Economics*, 5th ed., CRC Press, Taylor & Francis Group, 2007).

All the reactors are similar in design with the exception of the number and size of catalyst beds. Each reactor starts with an inlet filter tray system prior to the process stream entering the first bed. The filters are the cartridge type, using catalysts as a filter medium. Each catalyst bed consists of a distributor tray, a top layer of 1-in., Raschig rings and a second layer of ¼ in. Raschig rings, a predetermined amount of catalyst, and 150 – mm of ¼ in. ceramic balls, which support this catalyst. The Raschig rings, catalyst, and ceramic balls all rest on three layers of a 9-mesh support screen, which is supported by the quench deck grating.

The quench deck section consists of the deck grating, quench ring, swirl vane outlet and the deck plate. All the beds are constructed in this manner, except the lower portion of the bottom bed.

The lower portion of the bottom bed consists of a 402 mm layer of ½ in. ceramic balls and a 250 mm layer of ¼ in. ceramic balls supporting the bottom bed. The remaining pieces of equipment in the bottom bed are the outlet basket and screen, which are completely covered by the K-aggregate, and the quench pipes, which are in the reactor connected to the individual quench decks.

The reactors have two catalyst downcomer/reactor chain sleeves in each bed for catalyst removal, and two thermowell sleeves for bed temperature measurement. The catalyst downcomer must be filled with K-aggregate around the chain to minimize bypassing. There are no side manways on the reactor as all the work must be carried out from the top nozzle, which has an internal diameter of 625 mm. Also, all equipment must be able to fit through this inside diameter.

The initial loading of the catalyst must commence in the bottom bed. Using a canvas sock, load 402 mm of ½ in. ceramic balls into the bottom bed and then level, followed by another load of 250 mm of ¼ in. ceramic balls and levelled. The ½ in. ceramic balls are used only in the bottom bed. After the ceramic balls are loaded and levelled, loading of the catalyst can then commence. The sock should not be higher than 1 m above the catalyst level to minimize damage and breakage of the catalyst. The catalyst is periodically levelled during loading by raking, e.g., every 2 to 3 m, ensuring that the catalyst is not damaged. During this moment, the sock is emptied retaining a 150 mm layer of ¼ in. Raschig rings and a 250 mm layer of 1 in. Raschig rings are loaded on top of the catalyst bed. The Raschig rings cannot be loaded using the sock or excess breakage might occur. They must be brought down by means of canvas transport bags. After completion of this process, the sock is moved to the next higher bed in the reactor. The loaded bed must be operational by removal of all maintenance material, levelling of Raschig rings, and replacing distributor tray sections that were removed for access.

Catalyst Unloading

The catalyst unloading is an operation that requires preparation for a wide range of problems as:

1. Upon opening the bottom catalyst unloading nozzle, there is a possibility that the catalyst will be free-flowing and the reactor will empty itself. The nozzle should be filled with a slide gate valve so that the flow of catalyst can be halted.

2. The catalyst may be pyrophoric. Fire extinguishing equipment should be available for immediate use, if required.
3. The gas in the reactor is primarily nitrogen, but may contain H₂S and hydrogen.

After removing blind flange and attaching slide gate valve to catalyst unloading nozzles, the internal stop plate is removed by rotating ~ 1/6 of a turn. The catalyst may start to flow, or may require the use of a chain that runs through the length of the reactor, which may be pulled from the top to help loosen the catalyst and filler material in the downcomers and thus to maintain the flow through the catalyst downcomers. Figure 7.25 shows a schematic of a fixed-bed hydrocracking reactor.

7.16 Hydrocracker Fractionating Unit

The hydrocracker fractionating unit processes liquid hydrocarbon product from hydrocracker reactor to separate gas oil, kerosene, naphtha, sour LPG and sour fuel gas. The unit consists of three main sections:

- Main fractionator
- Debutanizer
- Mild vacuum column.

Main Fractionator

The feed to the main fractionator comes from the reactor section low-pressure separator. This is then preheated in the reactor section by heat exchange with the reactor effluent. A bypass of cold liquid from the low-pressure separator provides temperature control. The feed enters the main fractionator on tray no. 16 as a liquid and vapor mixture. The main fractionator reboiler pump circulates the column bottoms through the reboiler furnace. Fuel gas to the burners is controlled and reset by the main fractionator feed flow. A calculated amount of medium-pressure (MP) steam can also be injected as a stripping medium for maximum kerosene gain. The main fractionator bottoms pump, pumps the net bottoms product to the mild vacuum column via the kerosene strippers and debutanizer reboiler. The flow controller is reset by the bottoms level controller in the main fractionator. A slip stream of cooled bottoms product is returned to the main fractionator, which ensures that the heat input from the furnace is adequate to allow reboiling of the kerosene-stripper and debutanizer with the main fractionator bottoms product.

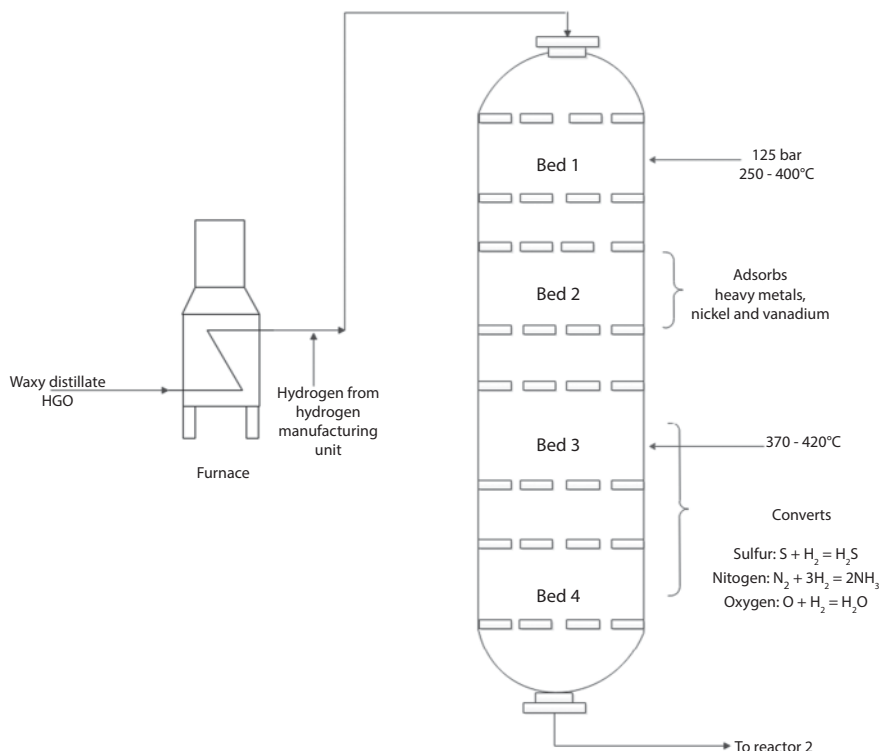


Figure 7.25 1st stage fixed-bed hydrocracking reactor with waxy distillate as feed from VGU.

The kerosene is withdrawn from tray no. 32 and is fed to the top tray of kerosene stripper. The flow is controlled by a flow controller and reset by the temperature on tray no. 28. The kerosene stripper reboiler is reboiled by the fractionator column bottoms. The stripper vapor is returned to the main fractionator below the kerosene draw-off tray. The kerosene stripper bottoms pump, pumps the kerosene to the product blending using a level controller. The total bypass of pumps has provided for normal use, and rather than using pumps, the hot kerosene is first used to preheat the debutanizer feed. The final cooling is achieved by kerosene product air cooler.

The main fractionator overhead vapor is partially condensed in the condenser; the fan pitch of the air cooler is controlled by the outlet temperature controller, which is reset by a level controller. Phase separation occurs in the main fractionator reflux drum and the hydrocarbon liquid is returned to the main fractionator as reflux via the main fractionator reflux pump. The flow controller is reset by the temperature controller on tray no. 47. A boot on the reflux vessel is provided to collect the small amount of the condensate that forms. This is then drained manually as required and sent to the sour water stripper unit.

The vapor from the reflux drum is further cooled and condensed in the main fractionator top product air cooler and trim cooler. Phase separation occurs in the main fractionator top product vessel. The liquid hydrocarbon is fed to the debutanizer. The level is maintained in the vessel by a level controller, which resets the flow controller. The condensate and water from the vessel are collected in the boot of the top product vessel and sent to sour water stripper unit.

The vapor from the top product vessel is compressed and sent to the debutanizer. In protecting the debutanizer feed compressors against H_2S corrosion, the vapor is first fed to the ADIP treating unit. A slip stream of compressed vapor is recycled to the reflux vessel to control the pressure in the main fractionator. The debutanizer feed compressors are motor-driven reciprocating compressors. They are equipped with lube oil systems consisting of pumps, filter, cooler and closed-cooling water system, which has a tank, pumps and cooler.

The liquid hydrocarbon from the top product vessel is pumped through the debutanizer feed preheat train via the debutanizer feed pump. The preheat train consists of naphtha product exchanger, kerosene product heat exchanger and MVC circulating reflux exchanger.

The feed rate is controlled by the level in the top product vessel. The flow control valve is located so that vaporization occurs only in the last exchanger of the preheat train. The preheat feed enters the debutanizer on tray no. 25. The feed temperature is controlled by the MVC circulating reflux around the exchanger. The net flow of vapor from the debutanizer feed compressor is fed to the debutanizer below tray no. 28.

The debutanizer splits the feed streams into LPG and full-range naphtha. The debutanizer reboiler is used to reboil the bottoms product from the main fractionator. The naphtha from the bottom of the debutanizer preheats the debutanizer liquid feed in the exchanger and further cooling is achieved in the naphtha product air cooler. The naphtha is then run down to intermediate storage under the pressure of the column.

The debutanizer overhead vapor is partially condensed in the condenser and trim cooler. Phase separation occurs in the reflux vessel. The reflux is then pumped to the debutanizer via the reflux pump. Flow controller is reset by a combination of pentane content of the overhead vapor as measured by a controller and the level in the reflux vessel as measured by the level controller. Alternatively, the temperature on tray no. 42 can be used as the reflux control point rather than pentane in the overhead vapor.

The net liquid overhead product is pumped to ADIP treating unit via the debutanizer overhead liquid pump. The condensate that separates out in the reflux vessel collects in a boot. The water is drained to a vessel on the interface level control. The light hydrocarbons absorbed in this water steam are flashed off before sent to the sour water stripper unit. The debutanizer off-gas is sent to ADIP treating unit for treatment before being discharged to the LPG unit.

7.16.1 Mild Vacuum Column

The main fractionator bottoms are fed to the mild vacuum column after reboiling the kerosene stripper and the debutanizer. The feed enters the mild vacuum column on tray no. 8. The MVC reboiler pump circulates the column bottoms through MVC reboiler furnace. Fuel gas to the burners is controlled by a flow controller, which is reset by the feed flow rate to the column. The MVC bottoms pump then pumps the net bottoms product through the cooling circuit on the level controller. A slip stream of product returns to the bottom of the column to ensure that there is sufficient flow through the pumps. The MVC bottom is recycled to

the hydrocracker reactor via the air cooler exchangers. The residue is bled to fuel oil blend. In the event of an upset of the hydrocracker reactor, a maximum of 50% of the normal recycle flow is diverted to the flushing oil return system. The product which is directed to storage is then cooled by heat exchange with gas oil to prevent plugging due to its high pour point.

The mild vacuum column has a circulating reflux stream to provide column temperature control. Liquid is withdrawn from tray no. 17 and pumped via MVC circulating reflux pump through the debutanizer preheat train exchanger and MVC circulating reflux trim air cooler. The column temperature control is achieved in the exchanger by adjusting the fan pitch. The reflux is returned to the column on tray no. 21.

The gas oil product is withdrawn from tray no. 22. The tray is a total draw-off tray, and the product is collected in the MVC gas oil product vessel. All gas oil withdrawn is pumped by the MVC top reflux pump and approximately two-thirds of the gas oil is cooled in the MVC top reflux air cooler and is returned to tray no. 23. The remaining one-third of the gas oil is cooled in the MVC gas oil product cooler and sent to the product blending vessel.

When required to use the gas oil to cool the MVC bottoms in the exchanger, the gas oil flow is recycled to the MVC gas oil product vessel. The gas oil flow is controlled by the bottoms product temperature. The column vacuum conditions are maintained by a two-stage ejector set. The non-condensables are drawn through the overhead gas condenser. The condensed ejector steam and any liquid hydrocarbons are collected in MVC ejector condensate vessel.

The separated oil phase is intermittently pumped to wet slops via MVC slop oil pump; the condensate is pumped under level control to sour water stripper unit by MVC sour water pump. The off-gas, flowing via condensate knockout vessel is incinerated in special burners in the main fractionator reboiler furnace.

7.16.2 Steam Generation

Due to the high process temperature in the furnace, the flue gases contain a large amount of useful heat. The flue gases are combined in waste heat boiler and used to generate high pressure, superheated steam, which is discharged to the refinery high-pressure steam system.

High-pressure boiler feed water to the economizer is flow controlled by the set point adjustment by a

computer relay, which receives inputs from steam flow transmitter and level controller of the steam drum. The boiler feed water is heated in the economizer tubes and flows to the steam drum. The waste heat boiler water circulating pumps take suction from the steam drum and the pump the water through the boiler shock tubes and evaporator section back to the steam drum where steam is separated from the water phase. From the steam drum, the steam flows through the superheater. The final steam temperature is controlled by the high-pressure steam attemperator and exits to the high-pressure steam system.

7.17 Operating Variables

The variables that alter the product specifications are pressure, temperature, reflux, heat input and product draw-off rates. The system pressure normally remains constant and is not considered as a variable.

Main fractionator

The overhead naphtha product cut-point is controlled by adjusting the temperature controller, which resets the flow controller and maintains the desired temperature to produce a specification product. An ASTM distillation 95 percentage point analyzer QR-8 is provided as a guide.

The kerosene product flash-point is controlled by adjusting the flow of hot oil through the kerosene stripper reboiler, thereby changing the reboiling rate. A flash point analyzer QR-10 is provided as a guide. The kerosene cut-point is controlled by adjusting a temperature controller, which resets its flow controller and maintains the desired temperature to produce a specification product. A 95 percentage point analyzer, QR-9 is provided as a guide.

A gas-fired furnace provides the primary heat input to the fractionator. The firing rate is adjusted by ratio controller, which is reset by flow transmitter, feed to the fractionator.

Debutanizer

A choice of two methods is provided to control the pentane content in the overhead liquid. The first uses a chromatograph analyzer QRC-11 to master the split of the overhead liquid product and the reflux. The second option uses the temperature controller to master the same split. The chromatograph is the preferred option of control.

The butane content of the debutanizer bottoms product is contingent on the proper heat input with the reboiler, while the column has the proper reflux. The heat input is controlled by a flow of hot oil through the reboiler, and a true vapor pressure analyzer, QR-7 is provided as a guide.

Mild Vacuum Column

The gas oil cut-point is controlled by controlling the temperature of tray no. 15, which in turn resets the temperature controller on the circulating reflux stream that will regulate the rate of production. An ASTM 95 percentage point analyzer, QR-17 is provided as a guide.

A gas-fired furnace provides the primary heat input to the mild vacuum column. The firing rate is adjusted by the ratio controller, which is reset by a flow transmitter feed to the vacuum column. Figure 7.26 shows a schematic of the mild vacuum distillation column.

A Case Study: Process Simulation of Hydrocracking [1]

A vacuum gas oil (VGO) containing 950 lb mol/h, n-C₁₆H₃₄ and 30 lb mol/h, C₂H₆S (ethyl mercaptan) and 20 lb mol/h of C₅H₅N (pyridine) available at 500 °F and 100 psia requires to be hydrocracked. This feed is pumped to raise its pressure up to 900 psia before mixing with hydrogen stream that also needs to be compressed from 150 psia to 900 psia. The hydrogen is available at 400 °F. The mixed stream of oil feed and hydrogen is then heated to 600 °F before entering the hydrocracking reactor. The reactor products are then cooled before entering the distillation column to separate the gases and light components at the top. C₈H₁₈ is withdrawn in a side stream of the column. Also, heavier hydrocarbons are exiting the bottom of the distillation column. Perform a material and energy balance for the hydrocracking process. The reactions in the hydrocracking unit are:

Rxn	Reaction	Reaction type	Conversion (%)
1.	$C_{16}H_{34} + H_2 \rightarrow C_6H_{14} + C_{10}H_{22}$	Conversion	50
2.	$C_{16}H_{34} + H_2 \rightarrow 2C_8H_{18}$	Conversion	50
3.	$C_2H_6S + H_2 \rightarrow C_2H_6 + H_2S$	Conversion	100
4.	$C_5H_5N + 5H_2 \rightarrow C_5H_{12} + NH_3$	Conversion	100

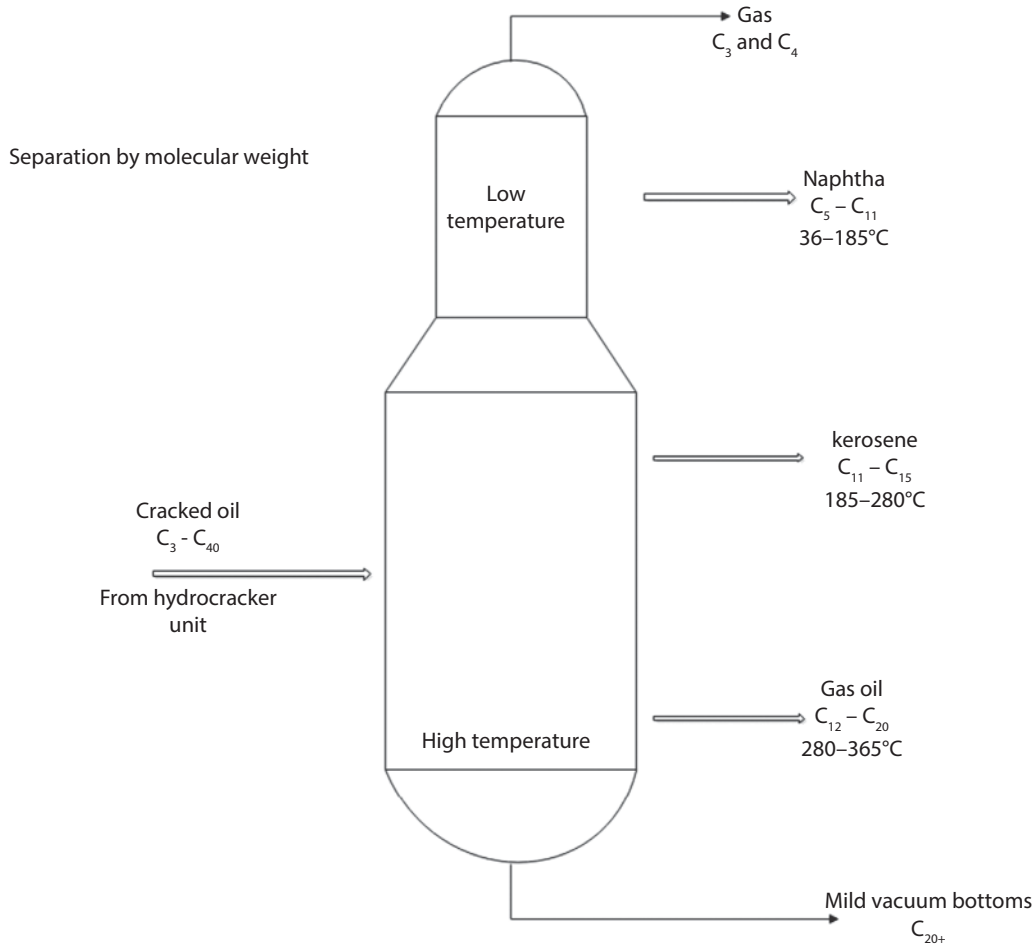


Figure 7.26 Separation by distillation from hydrocracker unit.

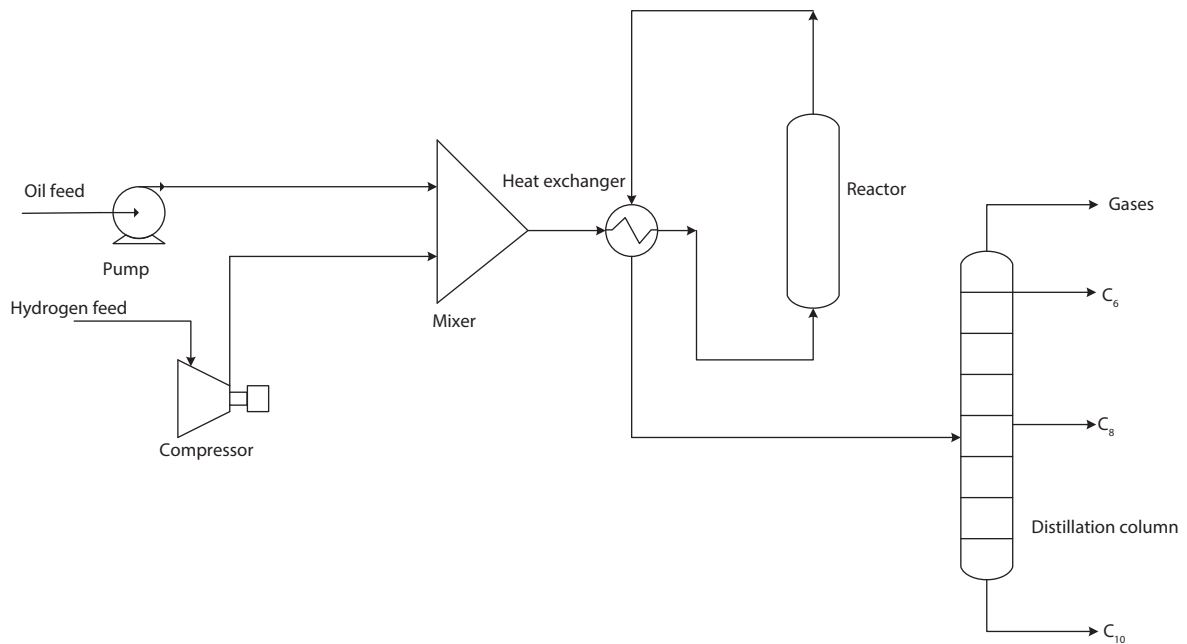


Figure 7.27 Schematic of hydrocracking process.

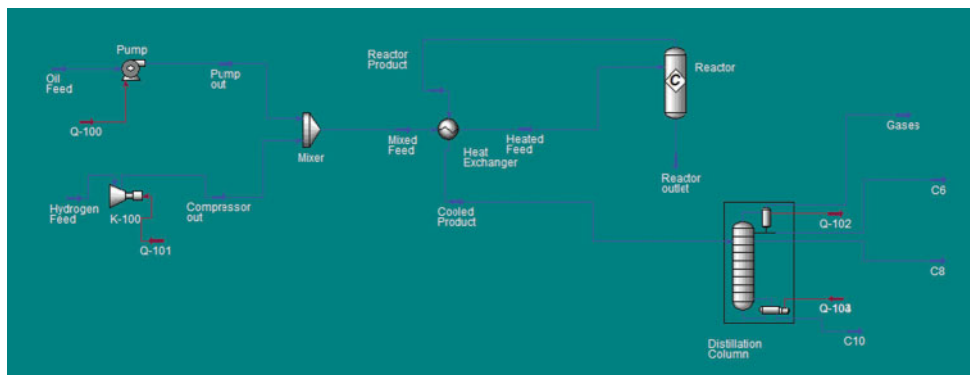


Figure 7.28 A snapshot of process flow diagram of hydrocracking simulation (Courtesy of Honeywell Process Solution, UniSim Design R443 (R), Honeywell (R) and UniSim (R) are registered trademarks of Honeywell International, Inc).

Solution

The schematic of the hydrocracking process is shown in Figure 7.27, and UniSim Honeywell simulation package was used to perform the mass and energy balance for the hydrocracking process. The process flow diagram from Honeywell Process Solution is shown in Figure 7.28. The procedure involves the following.

- To start a new case, select **File/New/Case** or press **Ctrl+N** or click on the **New Case**. This will open up the **Simulation Basis Manager** in UniSim.
- To add components to the simulation, click on the **Add** button in the Simulation Basis Manager. Clicking on **Add** will bring up the **Component List View** which is a list of all the components available in UniSim.
- Select the desired components as shown in Table 7.17 for the simulation. This can be searched through the list of components in one of three ways:
 - Sim Name
 - Full Name
 - Formula
- Once you have located the desired component, either double click on the component or click **←--- Add Pure** to add it to the list of components for the simulation.
- From the simulation basis manager, select the **Fluid Pkgs** tab.
- Click the **Add** button to create a new fluid package
- From the list of fluid packages, select the desired thermodynamic package. The list of available packages can be narrowed by selecting a filter to the left of the list (such as EOSs, activity models etc.)
- Once the desired model has been located, select it by clicking on it once. In this case study, select **Peng-Robinson** property package for the simulation.
- Click on Reactions tab in the Simulation Basis Manager window and Insert Reaction -1 stoichiometry and conversion; do the same for the subsequent Reaction -2, Reaction -3 and Reaction -4 as shown above.
- After the reaction set has been created, it must be added to the current fluid package in order for UniSim to use them.
 - Highlight the desired Reaction Set and Press **Add to FP**.
 - Select the only available Fluid Package and press the **Add Set** to the Fluid **Package** button.
- Once the reaction set is added to the Fluid Package, Click **Return to the Simulation Environment** and begin construction of the simulation. Make sure the **Solver** is active.
- To set the units, Click on the **Tools** menu and select **Preferences**. Then click on the **Variables** tab in the Session Preferences window. This displays **Available Unit Set**. e.g., NewUser, SI, etc. Click on the required unit for the simulation.
- Insert the first unit for the oil feed as shown in the flow chart with compositions, temperature and pressure.
- Continue inserting the units as shown in the chart.
- From the Object Palette, click **General Reactors** and select the **Conversion Reactor**.

Table 7.17 Material and energy balance results from UniSim simulation.

Stream name	Oil feed	H ₂ feed	Pump out	Compressor out	Mixed feed	Heated feed	Reactor product	Cooled product	Gases	C ₆ Stream	C ₈ Stream	C ₁₀ Stream
Temperature, °F	500	400	505.4	1157	529.3	600	707	643.3	95.9	95.48	376.8	466.3
Pressure, psia	100	150	900	900	900	898	898	896	50	50	63.33	70
Total molar flow (lb mol/h).	1000	1081.0	1000	1081.0	2081.0	2081.0	2001.0	2001.0	21.09	622.1	858.1	500
n-C ₁₆ H ₃₄ (lb mol/h)	950	0	950	0	950	950	0	0	0	0	0	0
Hydrogen (lb mol/h)	0	1081.0	0	1081.0	1081.0	1081.0	1.34	1.30	1.25	0	0	0
C ₂ H ₆ S (lb mol/h)	30	0	30	0	30	30	0	0	0	0	0	0
C ₅ H ₅ N (lb mol/h)	20	0	20	0	20	20	0	0	0	0	0	0
H ₂ S (lb mol/h)	0	0	0	0	0	0	30	30	6.99	23.0	0	0
NH ₃ (lb mol/h)	0	0	0	0	0	0	20	20	2.84	17.17	0	0
C ₂ H ₆ (lb mol/h)	0	0	0	0	0	0	30	30	8.23	21.77	0	0
n-C ₅ H ₁₂ (lb mol/h)	0	0	0	0	0	0	20	20	0.21	19.78	0	0
n-C ₆ H ₁₄ (lb mol/h)	0	0	0	0	0	0	475	475	1.62	470.23	3.09	0
n-C ₈ H ₁₈ (lb mol/h)	0	0	0	0	0	0	950	950	0	69.98	760	120

The simulation program (**Hydrocracking.usc**) can be accessed from Scrivener dedicated web site of this text.

Enter it into the PFD of the UniSim Simulation Environment window.

- The distillation column is 10 trays with partial reflux. The active specifications to run the distillation column are: C₁₀ recovery of 80%, C₈ recovery of 80%, C₆ recovery of 99% and draw rate is 226.8 kg mol/h. The pressure drop from top to bottom is 344.7 and 482.6 kPa respectively.
- Table 7.17 lists summary of the results and UniSim software (hydrocracking.usc) gives the results of the simulation exercise.

7.18 Hydrotreating Process

Hydrotreating in the refinery is the term used to describe the process of removing sulfur, nitrogen and metal impurities in the feedstock by hydrogen in the presence of suitable catalysts. Hydrotreating and hydrocracking set the two ends to the spectrum, and those processes with a substantial amount of sulfur or nitrogen removal and a significant change in boiling range of the products against the feed are referred to as hydroprocessing.

Hydrotreating is a process to catalytically stabilize petroleum products by converting olefins to paraffins or removes objectionable elements from

products or feedstocks by reacting them with hydrogen. Stabilization involves converting unsaturated hydrocarbons such as olefins and gum-forming unstable diolefins to paraffins. Elements removed by hydrotreating are: sulfur, nitrogen, oxygen, halides and trace metals as nickel, vanadium, etc. The process can be applied to a wide range of feedstocks from naphtha to reduced crude. When it is used to remove sulfur, it is referred to as hydrodesulfurization. Further, to meet environmental objectives, it also may be required to hydrogenate aromatic rings to reduce the aromatic content by converting it to paraffins.

Residuum desulfurization (RDS) and Vacuum residuum desulfurization (VRDS) hydrotreating processes are employed by refiners to produce low-sulfur fuel oils and to prepare feeds for vacuum gas oil (VGO) fluid catalytic crackers (FCCs), residuum FCCs (RFCCs), visbreakers and delayed cokers.

RDS/VRDS hydrotreaters upgrade residual oils by removing impurities and cracking heavy molecules in the feed to produce lighter product oils. Early applications of residuum hydroprocessing technology were used to remove sulfur from atmospheric residues (ARs) and vacuum residues (VRs), hence the term desulfurization. However, recent RDS/VRDS hydrotreaters perform excellently in removing nitrogen, carbon residue, nickel, vanadium from the oil and

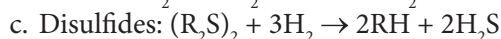
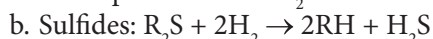
cracking heavy VR molecules to VGO, distillates and naphtha products. The amount of impurities removed depends on the feed and on the product specifications. Sulfur removal > 95 percent, metal removal (e.g., nickel and vanadium) > 98 percent, nitrogen removal > 70 percent, carbon residue reduction > 70 percent, and cracking of vacuum residue (1000 °F [538 °C] + material converted to 1000 °F [538 °C] -) as high as 60 liquid volume percent (LV %) had been commercially processed.

RDS/VRDS hydrotreating uses fixed beds of catalyst that operate at moderately high pressures [150–200 atm (152–203 bar)] and temperatures [662–797 °F (350–425 °C)] in a hydrogen-rich atmosphere (80–95 mol % hydrogen at the reactor inlet) to process the oil feed. The feed to a VRDS hydrotreater is normally the VR from a crude unit vacuum column with a typical starting true boiling point (TBP) cut point of 1000 °F

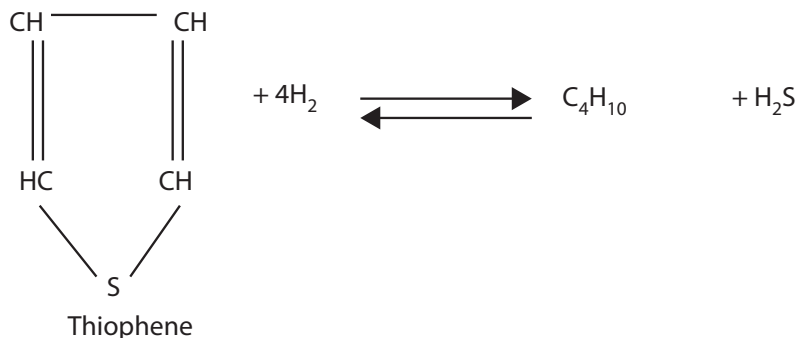
(538 °C), although cut points of 1067 °F (575 °C) and higher are suitable. The feed to an RDS hydrotreater is generally AR from a crude unit atmospheric column with a typical starting TBP cut point of 698 °F (370 °C). Other feed as solvent deasphalted oil, vacuum gas oil, and cracked gas oils from visbreakers, FCCs, (RFCCs, and cokers) can also be processed in either RDS or VRDS hydrotreaters.

The RDS hydrotreating unit has provided significant economic benefit to the refinery, and coke production has been reduced and the proportion of light products is higher than it would have been without the RDS. This involves converting VR (which would otherwise be fed to the coker unit) to VGO, diesel and naphtha in the RDS hydrotreater. Additionally, the hydrotreater VR from the RDS produces lower weight percent coke in the coker than the straight-run VR. Both of these effects result in lower coke production

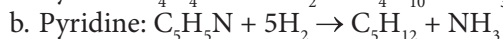
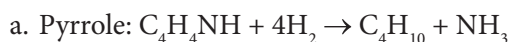
1. Desulfurization



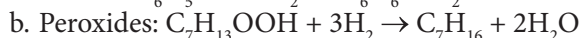
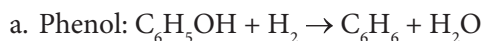
d. Thiophenes:



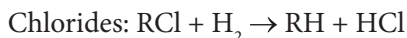
2. Denitrogenation



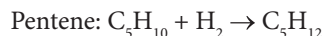
3. Deoxidation



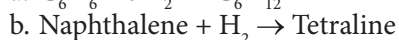
4. Hydrogenation of chlorides



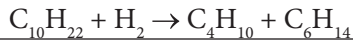
5. Hydrogenation of olefins



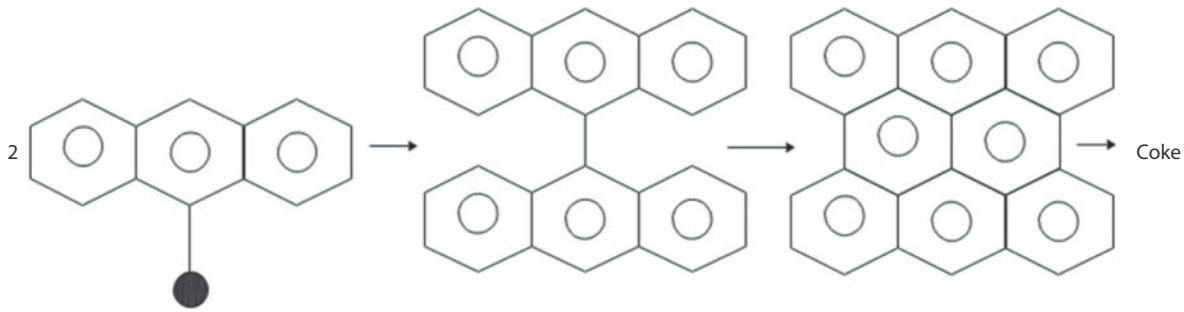
6. Hydrogenation of aromatics



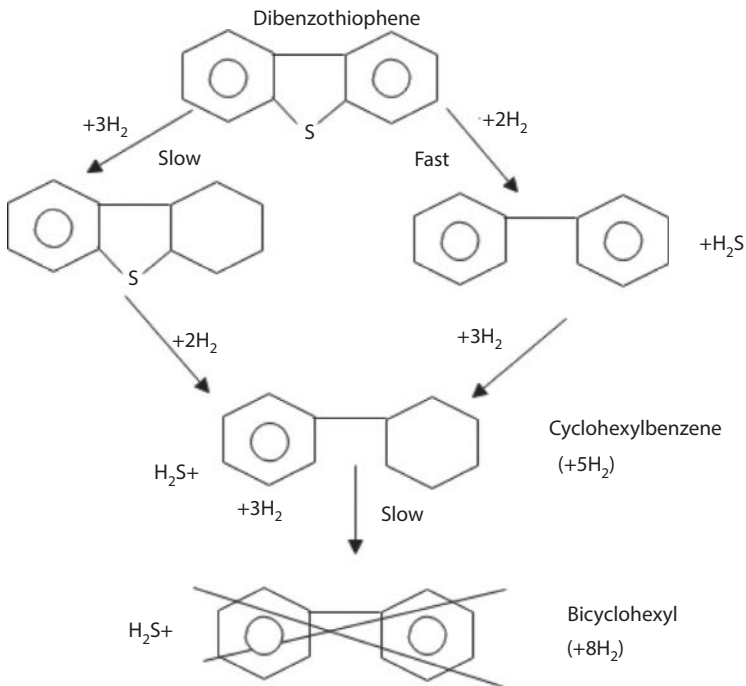
7. Hydrocracking



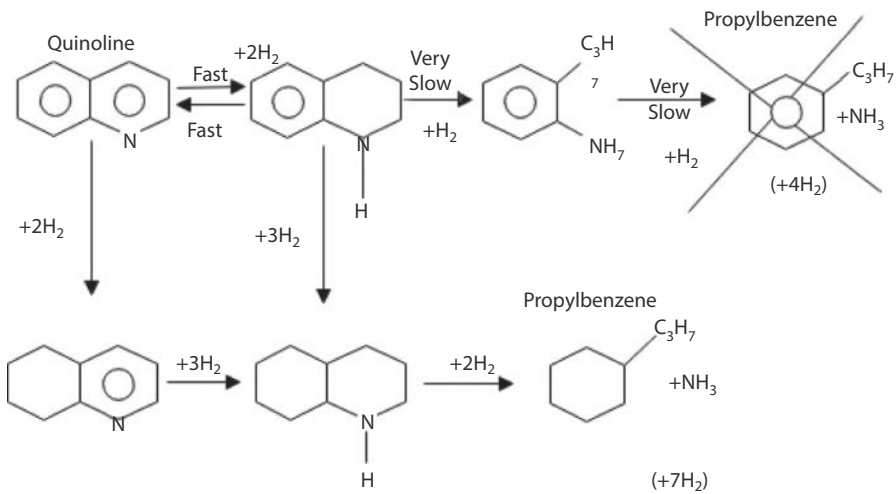
8. Coke formation by the chemical condensation of polynuclear radicals.



9. Typical desulfurization reaction. Sulfur can usually be removed without having to saturate aromatic rings.



10. Typical denitration reaction. Nitrogen can seldom be removed without saturating aromatic rings



and lighter products from the refinery. The main role of hydrotreating can be summarized as follows:

1. Meeting finished product specification
 - Kerosene, gas oil and lube oil desulfurization.
 - Olefin saturation for stability improvement.
 - Nitrogen removal.
 - De-aromatization for kerosene to improve cetane number, which is the percentage of pure cetane in a blend of cetane and alpha-methyl-naphthalene. The latter matches the ignition quality of kerosene sample.
2. Feed preparation for downstream unit.
 - Naphtha is hydrotreated for removal of metal and sulfur.
 - Sulfur, metal, polyaromatics and Conradson carbon removal from vacuum gas oil (VGO) to be used as FCC feed.
 - Pretreatment of hydrocarbon feed to reduce sulfur, nitrogen and aromatics.

Figure 7.29 shows the role of hydrotreating in the refinery.

Reactions

Any atom in a crude oil molecule that is neither hydrogen nor carbon is referred to as heteroatom. Heteroatoms are sulfur, nitrogen, oxygen, nickel, vanadium, iron, sodium, calcium and other less common atoms.

The main reaction in hydrotreating is that of desulfurization; however, many others take place to a certain degree proportional to the severity of the operation. Typical reactions are:

The ease of desulfurization is dependent upon the type of compound. Lower boiling compounds are desulfurized more readily than high-boiling ones. The difficulty of sulfur removal increases in this order: paraffins, naphthenes, aromatics [5]. Nitrogen removal requires more severe operating conditions than does desulfurization. For middle distillate fractions from crude oils containing high concentrations of nitrogen compounds, more efficient nitrogen reduction is achieved by using a catalyst charge of 90% nickel-molybdenum (NiMo) and 10% nickel-tungsten (NiW).

Hydrogen consumption of feed per percentage of sulfur is ~ 70 scf/bbl ($12.5 \text{ Nm}^3/\text{m}^3$), ~ 320 scf/bbl ($57 \text{ Nm}^3/\text{m}^3$) oil feed per percentage nitrogen and 180 scf/bbl ($32 \text{ Nm}^3/\text{m}^3$) per percentage oxygen removed. Hydrogen consumption for olefin and aromatics reduction can be determined from the stoichiometric

amounts required. It increases rapidly if operating conditions are high enough for an appreciable amount of cracking to occur. Hydrogen consumption can increase very rapidly. Therefore, it is important to note that actual hydrogen makeup requirements are from two to ten times the amount of stoichiometric hydrogen that is required.

7.18.1 Process Description

The oil feed is mixed with hydrogen-rich gas either before or after it is preheated to the reactor inlet temperature. Most hydrotreating reactions are carried out below 800 °F (427 °C) to minimize cracking, and the feed is heated to 500–800 °F (260–427 °C). The oil feed combined with the hydrogen-rich gas enters the top of the fixed-bed reactor. In the presence of the metal-oxide catalyst, the hydrogen reacts with the oil to produce hydrogen sulfide, ammonia, saturated hydrocarbons and free metals. The metals remain on the surface of the catalyst, and the other products leave the reactor with the oil-hydrogen stream. The reactor effluent is cooled before separating the oil from the hydrogen-rich gas. The oil is stripped of any remaining hydrogen sulfide and light ends in a stripper. The gas may be treated to remove hydrogen sulfide and ammonia, and then recycled to the reactor. Figure 7.30 shows the various reactor types used for hydrotreating and Figure 7.31 shows a typical process flow diagram of hydrotreating in the refinery.

7.18.2 Process Variables

The operating variables in hydrotreating processes are temperature, hydrogen partial pressure, and space velocity. Increasing hydrogen partial pressure and temperature invariably increases sulfur and nitrogen saturation but reduces coke formation. The hydrogen partial pressure must be greater than the hydrocarbon partial pressure, and these are ensured by high pressure and high hydrogen flow rate (make-up and recycle). The space velocity is an inverse of the residence time, and increasing space velocity reduces conversion, hydrogen consumption and coke formation. Higher temperatures will increase the reaction rate constant and improve the kinetics. The increase of temperature in the reactor improves the removal of sulfur and nitrogen, but an excessive temperature will result in thermal cracking and an increased coke formation.

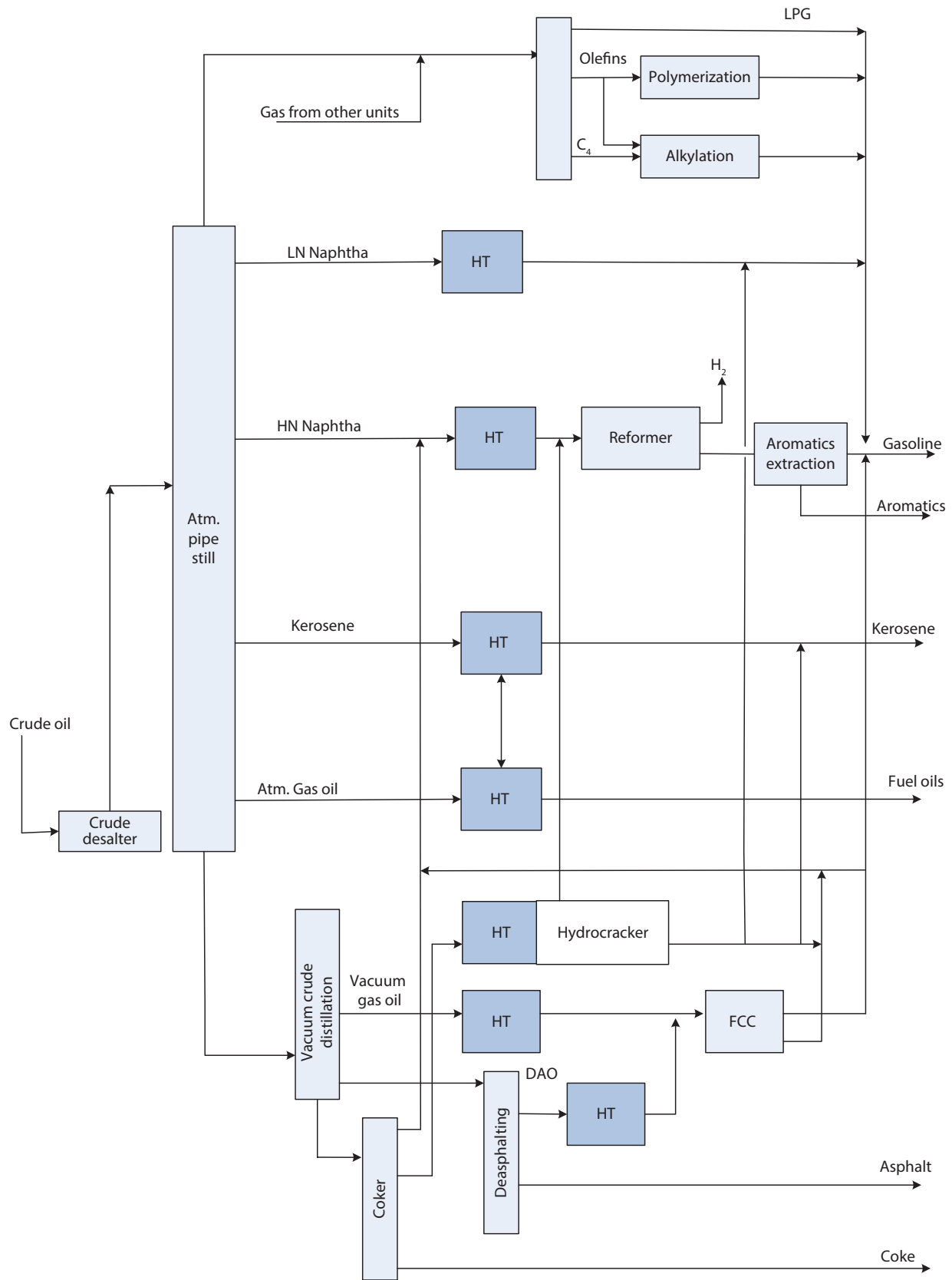


Figure 7.29 Role of hydrotreating (HT) in the refinery.

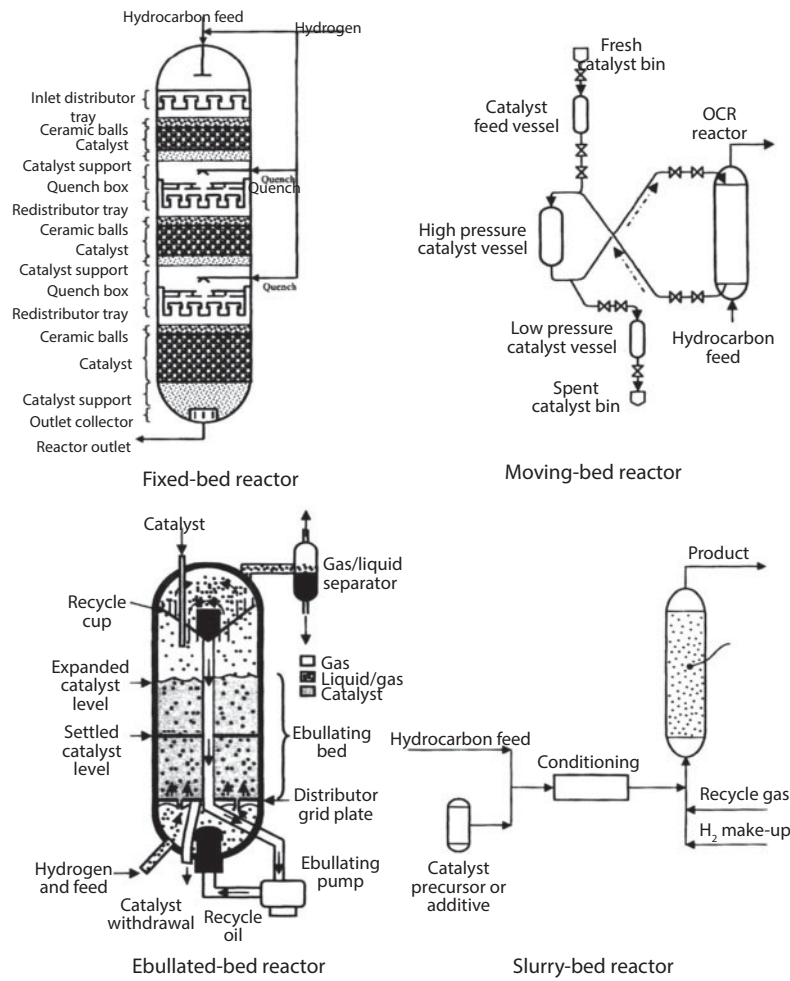


Figure 7.30 Examples of FBR, MBR, EBR and SPR for catalytic hydrotreating (Source: Jorge Ancheyta, *Modeling and Simulation of Catalytic Reactors for Petroleum Refining*, John Wiley & Sons, Inc., 2011).

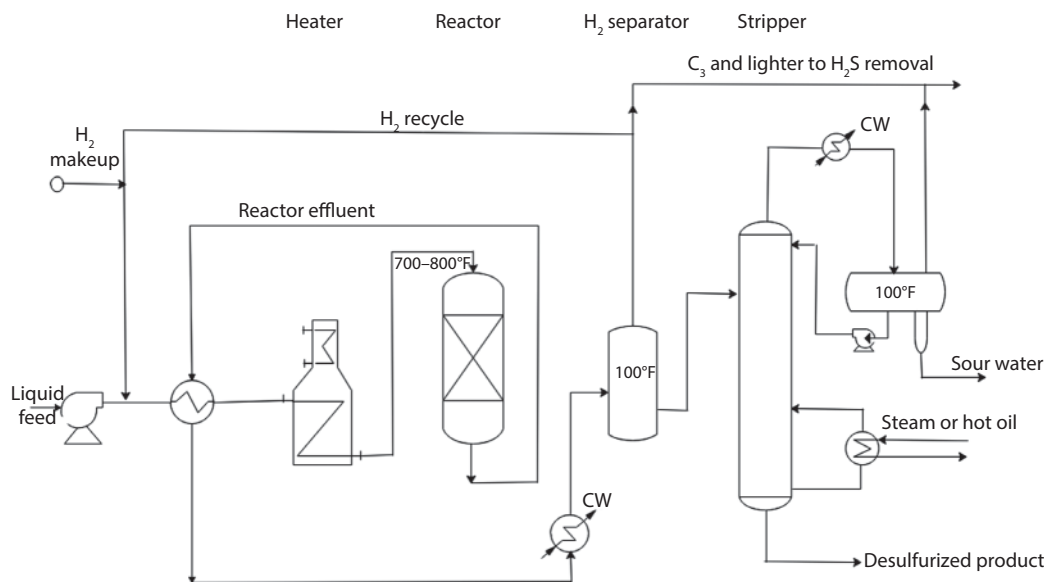


Figure 7.31 Process flow diagram of hydrotreating.

Typical ranges of process variables in hydrotreating operations are [5]:

Temperature	520–645 °F	270–340 °C
Pressure	100–3,000 psig	690–20,700 kPag
Hydrogen, per unit of feed recycle	2,000 scf/bbl	360 Nm ³ /m ³
Consumption	200–800 scf/bbl	36–142 Nm ³ /m ³
Space velocity (LHSV)	1.5–8.0	

Heinrich and Kasztelan [16] have provided process parameters for hydrotreating different feedstocks as shown in Table 7.18.

7.18.3 Hydrotreating Catalysts

Suitable catalysts are essential for hydrotreating process of RDS/VRDS and other oil feed that are mixed with hydrogen-rich gas. These catalysts include tungsten (W) and molybdenum sulfides on alumina. Cobalt and molybdenum sulfides (CoMo) on alumina supports are the most economic catalysts for sulfur removal. However, the most efficient removal of nitrogen are catalysts composed of nickel-cobalt-molybdenum or nickel-molybdenum (NiMo) compounds supported on alumina (Al₂O₃). Since nitrogen is usually more difficult to remove from hydrocarbon streams than sulfur, any treatment that reduces excess nitrogen concentration usually will effectively remove excess sulfur.

Nickel-containing catalysts require activation by presulfiding with carbon disulfide (CS₂), mercaptans (CH₃SH), or dimethyl sulfide (C₂H₆S₂) before bringing up to reaction temperature. However, some refiners employ activated cobalt-molybdenum catalysts by injecting the sulfiding chemical into the oil feed during start-up. The sulfiding reaction is highly exothermic, and due caution is required to prevent excessive

temperatures during activation thus preventing permanent catalyst deactivation.

Cobalt-molybdenum (CoMo) catalysts are selective for sulfur removal, and nickel-molybdenum (Ni Mo) catalysts for nitrogen removal, although these types will remove both sulfur and nitrogen. Nickel-molybdenum catalysts have a higher hydrogenation activity than cobalt-molybdenum, which results at the same operating conditions in a greater saturation of aromatic rings. This is because, if sulfur reduction is required, then a cobalt-molybdenum catalyst will reduce the sulfur at a given amount, and at the least severe operating conditions with lower hydrogen consumption than a nickel-molybdenum catalyst. However, if nitrogen reduction or aromatic ring saturation is required, nickel-molybdenum catalyst is the preferred catalyst.

Also, the ability to adjust pore size to concentrate pores around a particular diameter can impact the hydrotreating activity. A smaller size will favor hydrodesulfurization (HDS) on the expense of hydrometallization (HDM). In the hydrotreating of gas oils (400–1050 °F [200–566 °C]), the reactions taking place require a minimum pore size to overcome most diffusional restrictions. Pores that are larger than required do not improve diffusional characteristics, and as the pore diameters of the catalyst increase, the surface area decreases (at constant pore volume). Activity of the catalyst generally decreases with surface area, and loss in pore volume occurs in the smallest diameter pores. Figure 7.32 illustrates how catalysts with different pore diameters can influence the balance between hydrodesulfurization and hydrometallization and Table 7.19 shows the reactivities of each catalyst.

7.19 Thermodynamics of Hydrotreating

There are differences in the removal of various impurities, mainly because of the structure of the different

Table 7.18 Process parameters for hydrotreating different feedstocks [16].

Feedstock	Naphtha	Kerosene	Gas oil	Vacuum gas oil	Residue
Boiling range, °C	70–180	160–240	230–350	350–550	> 550
Operating temperature, °C	260–300	300–340	320–350	360–380	360–380
Hydrogen pressure, bar	5–10	15–30	15–40	40–70	120–160
Hydrogen consumption, wt %	0.05–0.1	0.1–0.2	0.3–0.5	0.4–0.7	1.5–2.0
^a LHSV, hr ⁻¹	4–10	2–4	1–3	1–2	0.15–0.3
H ₂ /HC ratio, std m ³ /m ³	36–48	36–48	36–48	36–48	12–24

^aLHSV = Liquid volume hourly flow rate at 15 °C (ft³/h)/Volume of catalyst (ft³).

molecules. Hydrodesulfurization (HDS) and olefin saturation are the most rapid reactions and hydrodenitrogenation (HDN), and hydrodearomatization (HAD) are the most difficult. In contrast to HDS, for HDN the aromatic must first be saturated, and then the nitrogen is removed. Most of the reactions are reversible with the exception of HAD, which is equilibrium that is limited at high temperatures; as at these conditions the reverse reaction of naphthene dehydrogenation is favored.

The reactions taking place in hydrotreating processes are highly exothermic, causing an increase in the reactor temperature as the feed passes through the catalyst beds. The reactor ΔT value depends on the concentration of each heteroatom and the extent of each reaction during hydrotreatment. The heat of the reaction varies significantly among the different reactions and from one compound to the other (Table 7.20). As the number of moles of hydrogen required removing

each organocompound increases, the amount of heat released also increases.

Table 7.20 shows the equilibrium constants of different hydrotreating reactions and the following observations are:

- The values of K_{eq} of HDS and HDN are positive over a wide range of temperatures (within values commonly reported on a commercial scale), which indicate that these reactions are essentially reversible and can proceed to completion if hydrogen is present in stoichiometric quantity.
- In general, as the temperature increases, the value of K_{eq} decreases, which is in agreement with the exothermicity of the reactions.

HDS reactions are generally straightforward except those of aromatic sulfur species that start with ring opening and sulfur removal, followed by saturation of the resulting olefin. In the HDS of dibenzothiophenes, there are two pathways: direct hydrodesulfurization where the sulfur atom is removed from the structure and then replaced by hydrogen without hydrogenation of any of the other carbon-carbon double bonds; and the hydrogenation route that assumes at least one aromatic ring adjacent to the sulfur-containing ring is first hydrogenated before the removal of sulfur. Additionally, an aromatic ring may be hydrogenated after sulfur removal. The hydrogenation pathways are subjected to thermodynamic equilibrium constraints. Therefore, the partially hydrogenated intermediates have lower equilibrium concentrations at higher temperatures and HDS via the hydrogenated route becomes limited at low pressures and high temperatures.

The hydrogenation of aromatic ring compounds is also an exothermic reaction, and the equilibrium yields are favored by low temperatures. The maximum aromatic reduction (i.e., optimum reaction temperature) is dependent on the types and amount of aromatic compounds in the feed, space velocity, hydrogen partial pressure and catalyst type. However, complete

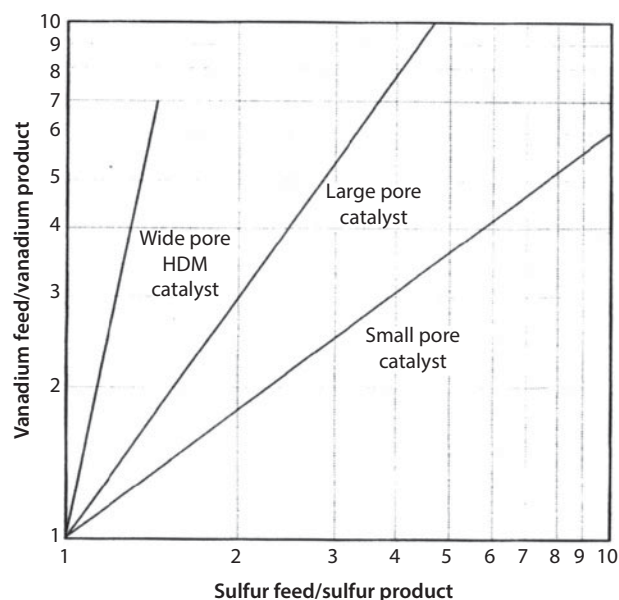


Figure 7.32 General relationship between vanadium and sulfur removal for different Co-Mo catalyst (Source: Raseev, S., *Thermal and Catalytic Processes in Petroleum Refining*, Marcel Dekker, New York, 2003).

Table 7.19 Reactivities of hydrotreating catalyst.

Catalyst	Hydro-desulfurization	Hydro-denitrogenation	Aromatics hydrogenation
Co - Mo/Alumina	Excellent	Good	Fair
Ni - Mo/Alumina	Very good	Very good	Good
Ni - W/Alumina	Good	Good	Excellent

Table 7.20 Equilibrium constants and standard enthalpies of various hydrotreating reactions [12].

Reactions	$\log_{10} K_{eq}$ at Temperature (°C)					ΔH ^o _a
	25	100	200	300	400	
Hydrodesulfurization						
$C_3H_7SH + H_2 \rightleftharpoons C_3H_8 + H_2S$	10.37	8.57	6.92	5.87	5.15	-57
Thiophene + $3H_2 \rightleftharpoons nC_4H_{10} + H_2S$	30.84	21.68	14.13	9.33	6.04	-262
Benzothiophene + $H_2 \rightleftharpoons$ ethylbenzene + H_2S	29.68	22.56	16.65	12.85	10.20	-203
Dibenzothiophene + $2H_2 \rightleftharpoons$ biphenyl + H_2S	24.70	19.52	15.23	12.50	10.61	-148
Hydrodenitrogenation						
Indole + $3H_2 \rightleftharpoons$ ethylbenzene + NH_3	-	-	-	7.8	5.0	-49
Carbazole + $2H_2 \rightleftharpoons$ biphenyl + NH_3	-	-	-	6.8	5.1	-126
Pyridine + $5H_2 \rightleftharpoons$ n-pentane + NH_3	-	-	-	8.9	4.4	-362
Quinoline + $4H_2 \rightleftharpoons$ propylbenzene + NH_3	-	-	-	7.0	3.3	-272
Hydrogenation of aromatics						
Naphthalene + $2H_2 \rightleftharpoons$ tetralin	-	-	1.26	-1.13	-2.80	-140
Tetralin + $3H_2 \rightleftharpoons$ trans-decalin	-	-	0.74	-2.95	-5.56	-193
Cyclohexylbenzen + $3H_2 \rightleftharpoons$ cyclohexylhexane	-	-	2.47	-1.86	-4.91	-295
Phenanthrene + $4H_2 \rightleftharpoons$ octahydrophenanthrene	-	-	1.16	-3.64	-7.12	-251

^aStandard enthalpy of reaction in kJ/mol organic reactant.

hydrogenation of aromatics is not feasible due to equilibrium limitations under typical hydrotreating conditions.

For the hydrodearomatization reaction to proceed, the polynuclear aromatics are first hydrogenated to three-ring to two-ring to one-ring and to the end products (naphthenic rings). Saturation of the final aromatic ring is difficult because of the resonance stabilization of the monoaromatic ring.

Olefin saturation is very rapid and highly exothermic. HDN shows a heat of reaction of 1 Btu/lb of feed for each 100 ft³ of hydrogen consumed, and the olefin saturation generates 1 Btu/lb of feed for each 2ft³ of hydrogen consumed. Diolefins are readily hydrogenated to olefins at low temperatures. Heats of hydrotreating reactions reported by Tarhan [13] and used for hydrotreating of straight-run gas oil are:

Hydrodesulfurization	-251,000 kJ/mol
Hydrodeoxygenation	-68,200 kJ/mol
Hydrodenitrogenation	-64,850 kJ/mol
Hydrocracking	-41,000 kJ/mol
Hydrogenation	-125,520 kJ/mol

The reaction rates increase with temperature and hydrogenation of aromatic ring compounds is a compromise between using low reactor temperatures to achieve maximum reduction of aromatic content and

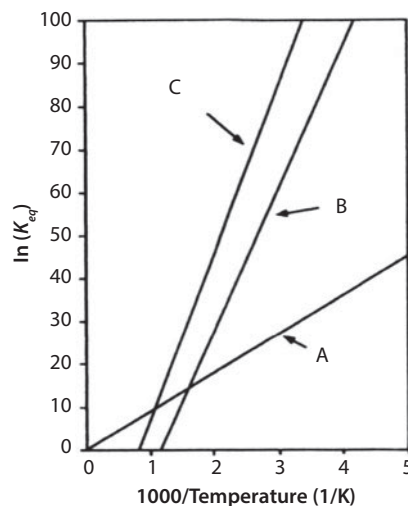
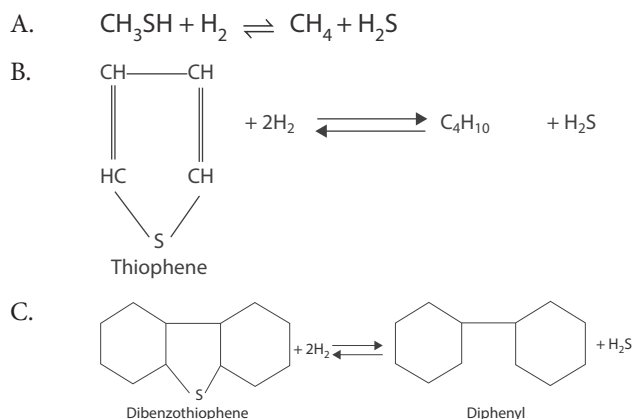


Figure 7.33 Thermodynamic limitations of hydrodesulfurization reactions.

a high temperature to give high reaction rates and a minimum amount of catalyst charge per barrel of feed.

The equilibrium constants, K_{eq} are positive (Figure 7.33) for several hydrodesulfurization reactions indicating that these reactions can proceed to completion if hydrogen is present in the stoichiometric quantity. The equilibrium conversions decrease with increase in temperature, and commercial hydrotreating process is carried out at high temperatures to

promote the kinetics of these reactions, as illustrated in the following reactions:



A conversion of 0.99 for thiophene hydrogenated to butane can be achieved at 220 psia (15 bara) and 743 °F (395 °C), while pyridine conversion to pentane at the same condition is 0.97. A conversion of 0.4 is achieved for hydrogenation of naphthalene (aromatics) to tetrahydronaphthalene at the same operating conditions.

For aromatic reduction, the maximum that can be achieved is between 700–750 °F (370–400 °C) and it is usually between 705–725 °F (375–385 °C). This is due to the interrelation between thermodynamic equilibrium and reactions rates. Figure 7.34 shows the relationship between reaction temperature and pressure. For a given pressure, the optimum temperature is dependent on the types of aromatic compounds in the feed and space velocity.

7.20 Reaction Kinetics

Most of the kinetic studies of the various hydrotreater reactions were conducted using pure compounds (i.e., model compounds) as well as binary and multicomponent mixtures [13]. The available kinetic data with model compounds are represented by pseudo-first order rate equations or with Langmuir-Hinshelwood rate equations. However, the complexity of the individual reactions taking place in an extremely complex mixture and the interference of the products with those from other components of the mixture is unpredictable. Therefore, caution is required when applying the data from model compound studies to the behavior of petroleum and its distillates.

For the HDT of real feed, n^{th} -order kinetics with respect to total concentration of the heteroatom is

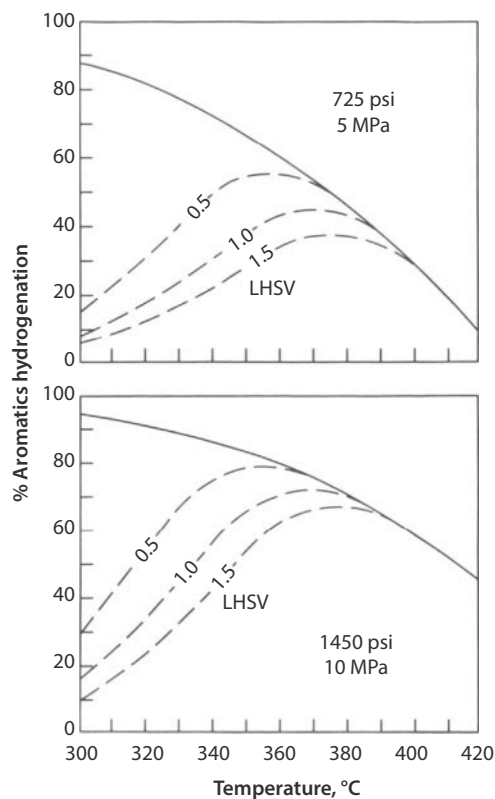


Figure 7.34 Kinetic rate and thermodynamic equilibrium effects on aromatic reduction [5].

normally used, in which the n value depends on several factors, such as type and concentration of the heteroatom, catalyst properties, type of feed, operating conditions, and experimental system, etc.

When the analysis is carried out as the total content of the heteroatom (e.g., total sulfur content, total nitrogen content), the kinetics is represented by n^{th} -order kinetics with respect to the total concentration of that heteroatom. The value of n for most hydrotreating reactions is in general > 1.0 . Table 7.21 shows reaction orders and activation energies for the dehydrosulfurization of different real feedstocks.

Yui and Sanford [10] developed a kinetic model for aromatics hydrogenation of Arabian gas oil and compared the results with a kinetic model based on a first order reversible reaction (Figure 7.35). This reaction is restricted by equilibrium at temperature above 680 °F (360 °C) and operating pressures of 725–1450 psia (5–10 MPa), which gave good agreement between the results and the model. At higher space velocities, a lower conversion is attained.

Table 7.21 Reaction Orders and Activation Energies for Hydrodesulfurization of Different Feedstocks [14].

Feed*	Density at 15 °C	Sulfur (wt %)	Distillation Range (°C)	n	E _A (kcal/mol)
Reaction Orders Calculated from Experimental Data					
SRGO	0.861	1.31	213–368	1.57	20.3
SRGO	0.843	1.32	188–345	1.53	
HSRGO	0.862	1.33	142–390	1.65	
SRGO-LCO	0.879	1.78	209–369	1.63	16.5
VGO	0.907	2.14	243–514	2.09	33.1
SRGO-LCO	0.909	2.44	199–370	1.78	16.37
Residue oil	0.910	3.45	–	2.0	68.6
Residue oil	0.950	3.72	281–538	2.0	29.0
Residue oil	1.007	5.30	–	2.5	36.1
AR	0.995	5.86	–	2.0	29.0
Reaction Orders Calculated from Experimental Data					
Used oil	0.900	0.70	–	1.0	19.6
Residue oil	0.969	1.45	–	1.0	24.0
SRGO	–	1.47	–	1.65	25.0
Residue oil	0.964	2.90	–	1.0	18.3
CGO	0.984	4.27	196–515	1.5	33.0

* SRGO, straight-run gas oil; HSRGO, heavy straight-run gas oil; LCO, light cycle oil; VGO, vacuum gas oil; AR, atmospheric residue; CGO, coker gas oil.

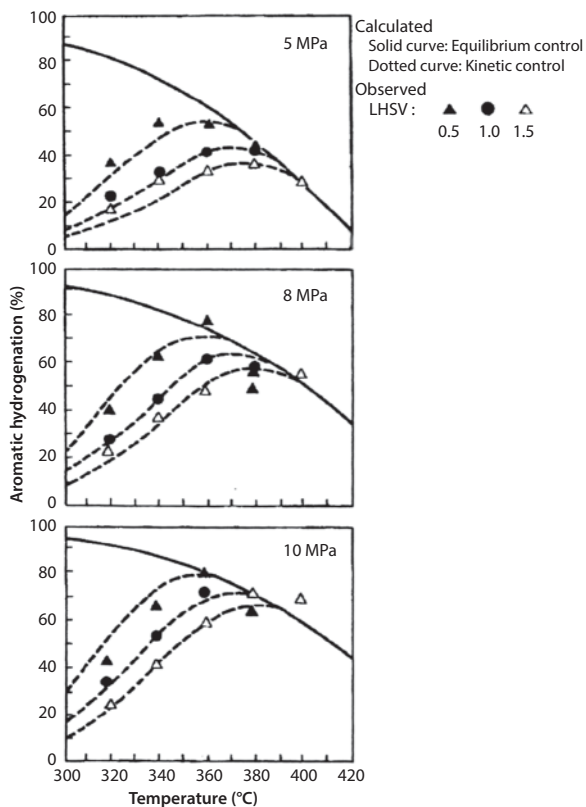


Figure 7.35 Observed and calculated percentage (%) aromatic hydrogenation at various operating conditions Arabian light gas oil (Source: Yui and Sandford [10]).

Example 7-4

Find the catalyst volume needed for hydrotreating gas oil containing 1.5 wt % sulfur to a final residual sulfur of 0.05 wt %. The reaction rate can be expressed as;

$$k = 3.7 \times 10^9 \exp\left(\frac{-13,200}{T}\right)$$

The desulfurization reaction temperature is 350 °C and the pressure is 2.1MPa. The reaction order is 1.5. The feed flow rate is 150,000 kg/h and has a density of 850 kg/m³.

Solution

The rate constant k is:

$$T = ^\circ\text{C} + 273.15 = (350 + 273.15) = 623.15\text{K}$$

$$k = 3.7 \times 10^9 \exp\left(\frac{-13,200}{623.15}\right) = 2.337 \text{ h}^{-1}$$

The feed volumetric rate, Q from the feed mass flow rate is:

$$Q = \frac{G}{\rho} = \frac{\text{Mass flowrate}}{\text{Density}} \left\{ \frac{\text{kg}}{\text{h}} \cdot \frac{\text{m}^3}{\text{kg}} \right\}$$

$$= \frac{150,000}{850}$$

$$= 176.47 \text{ m}^3/\text{h}$$

At $T = 625.15\text{K}$ and $k = 2.337 \text{ h}^{-1}$ using Eq. (7.13)

$$k = \frac{SV}{1-n} (C_{AO}^{1-n} - C_{Af}^{1-n}) \quad (7.13)$$

The liquid hourly space velocity (LHSV) or SV is:

$$2.337 = \frac{SV}{1-1.5} (1.5^{1-1.5} - 0.05^{1-0.5})$$

$$SV = \frac{(0.5)(2.337)}{3.656}$$

$$= 0.32 \text{ h}^{-1}$$

$$\text{Catalyst volume} = \frac{\text{volume of hourly feed rate}}{\text{Liquid hourly space velocity}}$$

$$= \frac{176.47}{0.32} = 552 \text{ m}^3$$

7.21 Naphtha Hydrotreating

Naphtha from the crude unit (CDU) or from the Visbreaker unit (VBU) is usually hydrotreated to remove the impurities so that the hydrotreated naphtha is then introduced to the catalytic reformer to improve octane or steam reforming for hydrogen production. The expensive platinum based catalyst used in the reformer is sensitive to poisoning by such impurities. The naphtha reformer consists of a feed heater, reactor, high and low pressure separators, recycle compressor and treated naphtha fractionator. A hydrogen sulfide (H_2S) scrubber is placed between the high and low pressure separators. Some of the recycle gas is purged to lower the concentration of light hydrocarbons ($\text{C}_1 - \text{C}_4$), and a catalyst of cobalt-molybdenum (Co Mo) on alumina is used in the reactor. Figure 7.36 shows a schematic of naphtha hydrotreating process. The operating conditions of a naphtha HDS unit for catalytic reformer feed are shown in Table 7.22. Corresponding feed and product properties and unit yields are shown in Tables 7.23 and 7.24 respectively.

7.21.1 Hydrotreating Correlations

Maples [15] provided empirical equations to predict the amount of hydrogen required for certain feeds.

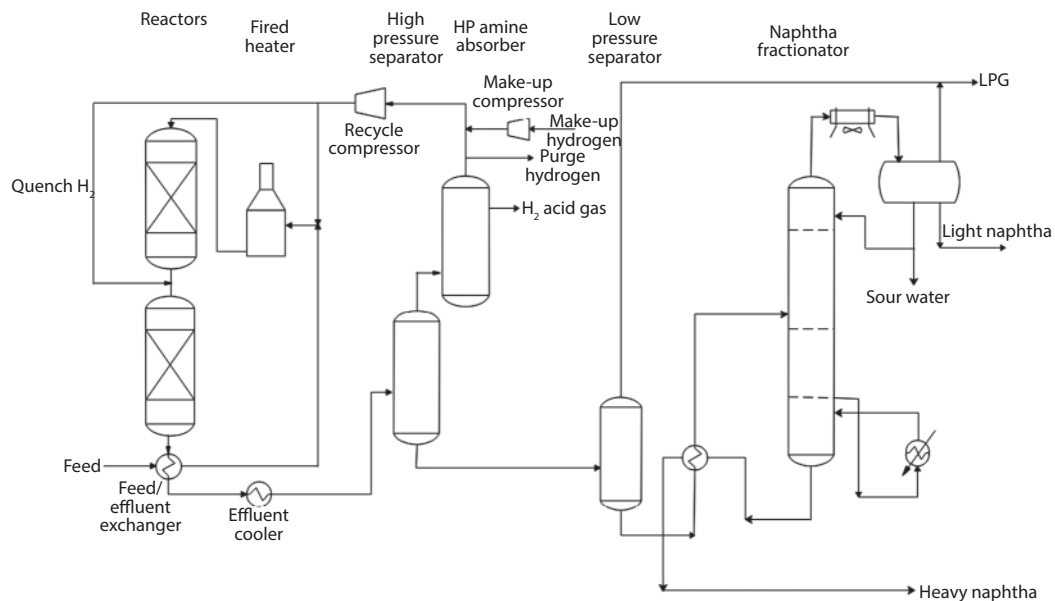


Figure 7.36 Process flow diagram of naphtha hydrotreating process.

Table 7.22 Naphtha hydrodesulfurization operating conditions [11].

Operating Parameters	Units	
Reactor inlet temperature		
SOR	°F	608
EOR	°F	698
Total pressure at separator drum	psia	303
Hydrogen partial pressure at reactor outlet	psia	160
Liquid hourly space velocity (LHSV)	hr ⁻¹	4.00
Hydrogen consumption	scf/bbl	45
Catalyst Co-Mo on Alumina support		
Typical Composition and Properties		
Co = 2.2 %, Mo = 12.0%		
Surface area = 225 m ² /gm		
Pore volume = 0.45 cm ³ /gm		
Crush strength = 30 kg		

Table 7.23 Naphtha hydrodesulfurization feed (Sulfur-run) and Product Properties [11].

Quality	Units	
Sulfur gravity		0.734
TBP Distillation		
IBP	°F	194
10%	°F	203
30%	°F	221
70%	°F	239
90%	°F	257
FBP	°F	284
Hydrocarbon type		
Paraffins	Vol%	69
Naphthenes	Vol%	20
Aromatics	Vol%	11
Total Sulfur	Wt%	0.015
Mercaptan		
Sulfur	Wt%	0.008
Total nitrogen	ppmw	1
Molecular weight		111
Product Sulfur	ppmw	0.5

IBP = Initial boiling point; FBP = Final boiling point

Table 7.24 Naphtha Hydrodesulfurization Unit Yields [11].

Yield Weight	
Feed	Fractions
Naphtha Feed	1.0
Hydrogen	0.08
Total Feed	1.000
Products	
Acid gas	0.0012
Hydrogen rich gas	0.0110
LPG Rich gas	0.0058
Hydrotreated naphtha	0.9900
Total product	1.0080

Naphtha and Gas Oil Hydrotreating

Correlations

The standard ft³ of hydrogen per barrel of feed (SCFB) required for complete sulfur removal is:

$$SCFB H_2 = 191S_f - 30.7 \quad (7.66)$$

where

S_f = sulfur wt % in feed

The increase in the API gravity of a product is:

$$\Delta(\text{API})_p = 0.01 \times (\text{SCFB } H_2) + 0.036 \times (\text{API})_f - 2.69 \quad (7.67)$$

where

p and f refer to product and feed respectively.

In cases where saturation of aromatics and naphthenes to the corresponding paraffin is required, a set of correlations for PNA analysis is required to predict the naphtha composition. These are expressed by:

$$\text{Vol \% Paraffins} = 12.8K_f^2 - 259.5K_f + 1330.0 \quad (7.68)$$

$$\text{Vol \% Naphthene} = -78.5K_f^2 + 1776.6K_f - 9993.7 \quad (7.69)$$

$$\text{Vol \% Aromatics} = 38.4K_f^2 - 894.3K_f + 5219.4 \quad (7.70)$$

where K_f is the feed Watson Characterization factor.

$$K_f = \frac{(^{\circ}F + 460)^{1/3}}{\text{SpGr}} \quad (7.71)$$

Example 7-5

It is necessary to hydrotreat naphtha that has 1.5 wt % S and API = 50. Determine:

- The amount of hydrogen required to remove all the sulfur in the feed by empirical correlations.
- The amount of H_2 required for chemical requirements.
- The means average boiling point of naphtha is 140 °F, and assuming the naphthene and aromatic present in the naphtha are cyclohexane (C_6H_{12}) and benzene (C_6H_6) respectively. Determine the volume of hydrogen in standard ft^3 of hydrogen per barrel of feed (SCFB) to convert all cyclohexane and benzene into hexane (C_6H_{14}).

Solution

Assume 1 bbl of naphtha feed:

- a. Hydrogen required for desulfurization:

$$SCFB H_2 = 191(1.5) - 30.7 = 255.8 \text{ ft}^3 / \text{bbl}$$

Hydrogenated naphtha API:

$$\Delta(API)_p = 0.01 \times (255.8) + 0.036 \times (50) - 2.69 \\ = 1.7$$

$$(API)_p = 50 + 1.7 = 51.7$$

- b. To determine hydrogen required for chemical requirements:

API = 50, the specific gravity SpGr is:

$${}^\circ API = \frac{141.5}{SpGr} - 131.5$$

$$SpGr = \frac{141.5}{(50 + 131.5)} = \frac{141.5}{181.5} \\ = 0.78$$

Density, ρ is $62.4 \times 0.78 = 48.67 \text{ lb}/ft^3$

$$\rho = 48.67 \frac{lb}{ft^3} \times \frac{ft^3}{7.4805 \text{ US gal}} \times \frac{42 \text{ US gal}}{1 \text{ US barrel}} \\ = 273.3 \text{ lb} / \text{bbl}$$

Amount of sulfur, S in the feed = $273.3 \times 0.015 = 4.10 \text{ lb}/\text{bbl}$

Mole of sulfur, S = $4.10 \text{ (lb/bbl)} / 32 \text{ (lb/lb mol)} = 0.128 \text{ lb mol}/\text{bbl}$

For the reaction: $S + H_2 \rightarrow H_2S$

H_2 required = $0.128 \text{ lb mol}/\text{bbl} \times 379 \text{ ft}^3/\text{lb mol} = 48.5 \text{ ft}^3/\text{bbl}$

(Note: At standard gas condition, 1 lb mol occupies 379 ft^3)

The difference in H_2 requirement = $255.8 - 48.5 = 207.3 \text{ ft}^3/\text{bbl}$

This difference includes purge and dissolution of hydrogen.

- c. From API = 50, SpGr = 0.78 at $T = 136 \text{ }^\circ\text{F}$, K_f is:

$$K_f = \frac{({}^\circ F + 460)^{1/3}}{SpGr} = \frac{(136 + 460)^{1/3}}{0.78} \\ = 10.81$$

Vol% Paraffins(hexane)

$$= 12.8(10.81^2) - 259.5(10.81) + 1330.0 \\ = 25.95 \text{ vol } \%$$

Vol % Naphthenes(cyclohexane)

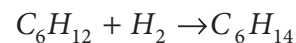
$$= -78.5(10.81) + 1776.6(10.81) - 9993.7 \\ = 38.142 \text{ vol } \%$$

Vol% Aromatics (benzene)

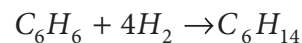
$$= 38.4(10.81^2) - 894.3(10.81) + 5219.4 \\ = 39.29 \text{ vol } \%$$

Hexane does not require H_2

1 mole of cyclohexane requires 1 mole of H_2 to produce 1 mole of hexane:



1 mole of benzene requires 4 moles of H_2 to produce 1 mole of hexane:



The volume of H_2 required to convert cyclohexane and benzene to hexane (assuming 1 bbl feed) is as follows:

	Molecular weight (lb/lb mol)	SpGr	Density lb/bbl	Volume fraction	Weight lb	Moles	Moles H ₂ required (lb mol/bbl)
Hexane (C ₆ H ₁₄)	86	0.655	229.5	0.2596	59.58	0.207	0
Cyclohexane (C ₆ H ₁₂)	84	0.811	284.1	0.3814	108.36	0.377	0.377
Benzene (C ₆ H ₆)	78	0.87	304.8	0.3929	119.76	0.416	1.664
					287.70		2.041

The final amount of H₂ required is:
 H₂ required = 2.041 (lb mol/bbl) x 379 ft³/lb mol = 774 ft³/bbl

The amount of hydrogen required for naphthenes and aromatics saturation is much higher than that required for other requirements such as sulfur removal.

7.21.2 Middle Distillates Hydrotreating

Middle distillate consists of saturated paraffins and some aromatics that include compounds with up to three aromatic rings. Kerosene, jet fuel (ATK) and diesel fuel are all derived from middle distillate fractions. Figure 7.37 shows a schematic of diesel fuel hydrotreating process. The feed stream is combined with recycled hydrogen and make-up hydrogen and heated in a fired heater. The reactor effluent is separated in a high-pressure separator into liquid and recycled hydrogen. The liquid is then flashed into

the low-pressure separator, producing a gas which is sent to the C₃ and C₄ recovery unit and a liquid which is sent to a fractionator that produces gases, naphtha, and hydrotreated diesel. A H₂S scrubber and gas purging are normally used to improve the quality of the recycled hydrogen. Figure 7.38 shows a photograph of kerosene hydrodesulfurizer reactor with feed/effluent shell and tube heat exchangers in series. Table 7.25 shows the operating conditions of a kerosene hydrotreating unit and the corresponding feed and product properties, unit yields and utility consumption, and specifications of dual-purpose kerosene are shown in Tables 7.26–7.29.

7.21.3 Middle Distillate Hydrotreating Correlations

The amount of hydrogen required is:

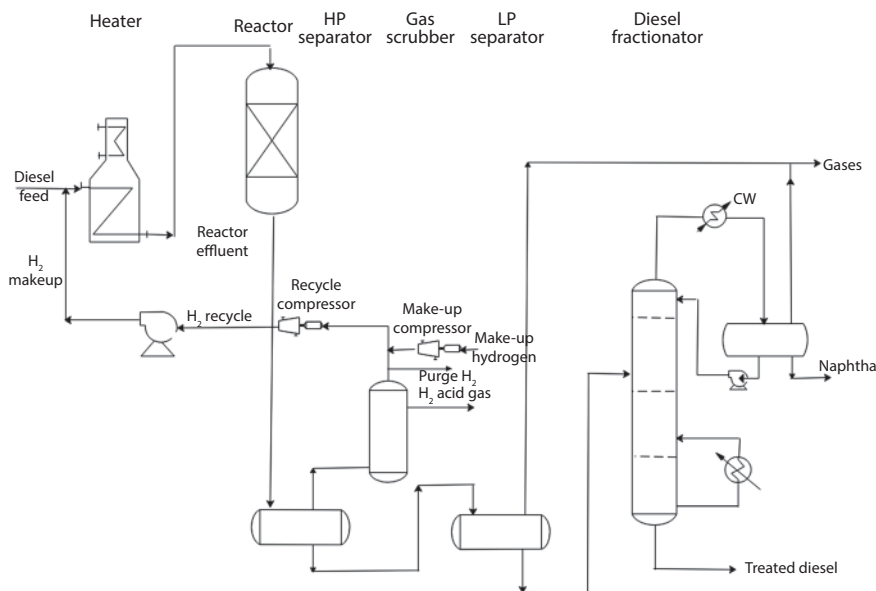


Figure 7.37 Diesel fuel hydrotreating process.



Figure 7.38 A photograph of kerosene hydrodesulfurizer reactor with feed/effluent shell and tube heat exchangers in series.

Table 7.25 Kerosene Hydrodesulfurization Operating Conditions [11].

Operating Parameters Units		
Temperature (W.A.B.T)		
SOR	°F	600
EOR	°F	698
Reactor ΔT	°F	30
Reactor Δp	psi	35
Total Reactor pressure	psig	1350
Hydrogen partial pressure	psia	1105
Recycle ratio	scf/bbl	3072
Hydrogen consumption	scf/bbl	555
% Desulfurization	wt %	99.6
% Denitration	wt %	98.0
Separator Drum		
Pressure	psig	1240
Temperature	°F	140
Recycle Gas Compressor		
Suction pressure	psig	1200
Discharge pressure	psig	1390
Discharge temperature	°F	161

W.A.B.T. = Weighted Average Bed Temperature.

$$\text{SCFH}_2/\text{bbl} = 110.8S_f + 10.2(\text{HDS}\%) - 659 \quad (7.72)$$

where S_f is the wt % sulfur in the feed and HDS % is the percentage of hydrodesulfurization required (degree of severity). The increase in product API is:

$$\begin{aligned} \Delta(\text{API})_p &= 0.00297 \times (\text{SCFH}_2/\text{bbl}) - 0.11205 \\ &\quad \times (\text{API})_f + 5.54190 \end{aligned} \quad (7.73)$$

where

p and f refer to product and feed respectively

Eq. 7.72 is used for feed sulfur content of 0.5–6.0 wt.

Example 7-6

Sulfur content of 2.0 wt% is fed into a hydrotreater. It is necessary to carry out HDS at a severity of 95%. Calculate the hydrogen required and the product API.

Solution

Assume 1 bbl of Gas oil, API = 35, the specific gravity SpGr is:

$$^\circ\text{API} = \frac{141.5}{\text{SpGr}} - 131.5$$

$$\text{SpGr} = \frac{141.5}{(35 + 131.5)} = \frac{141.5}{166.5}$$

$$= 0.85$$

Density, ρ is $62.4 \times 0.85 = 53.04 \text{ lb/ft}^3$

$$\begin{aligned} \rho &= 53.04 \frac{\text{lb}}{\text{ft}^3} \times \frac{\text{ft}^3}{7.4805 \text{ US gal}} \times \frac{42 \text{ US gal}}{1 \text{ US barrel}} \\ &= 298 \text{ lb / bbl} \end{aligned}$$

The amount of sulfur in the feed = $298 \times 0.02 = 5.96 \text{ lb/bbl}$

Total hydrogen required (SCFB H_2) is:

$$\begin{aligned} \text{SCFH}_2/\text{bbl} &= 110.8(2) + 10.2(90) - 659 \\ &= 480.6 \text{ ft}^3/\text{bbl} \end{aligned}$$

The increase in product API is:

$$\begin{aligned} \Delta(\text{API})_p &= 0.00297 \times (480.6) - 0.11205 \\ &\quad \times (35) + 5.54190 \\ &= 3.04 \end{aligned}$$

Product API = $35 + 3.04 = 38$

Table 7.26. Kerosene HDS Unit Feed and Product Properties [11].

Property	Feed	Naphtha	Light kerosene	ATK	Heavy kerosene
Aniline point °F	143				156.5
API Gravity	46.44	58.89	47.93	44.82	41.17
Density	0.7952	0.7432	0.7886	0.8025	0.8195
Aromatics (vol %)	22	10.8	18.2	19.1	19.9
Cloud point (°F)					2
ASTM distillation (°F)					
IBP	192	124	322	384	452
5 vol %	306	178	338	396	464
10 vol %	342	202	342	400	472
20 vol %	346	232	346	404	478
30 vol %	362	256	350	406	484
50 vol %	396	292	362	412	500
70 vol %	440	316	382	422	518
90 vol %	504	348	418	440	544
95 vol %	526	360	436	448	556
FBP	556	394	470	470	576
Flash point (°F)			140	184	226
Freeze point (°F)			-59	-54	
Pour point (°F)					Zero
Smoke point, mm	24		27	26	25
Sulfur, ppm	4500	1900	3	3.6	41.1
Kinematic viscosity at 122 °F, cSt	1.1		0.99	1.32	2.2

IBP = Initial Boiling Point; FBP = Final Boiling Point; ATK = Aviation Turbine Kerosene

Table 7.27 Kerosene HDS Unit Overall Yields [11].

Stream	Weight fraction
Feed	
Kerosene Feed	1.0000
H ₂ Gas	0.0137
Total Feed	1.0137
Products	
Gas from Unifiner	0.0109
HP Gas	0.0060
Acid Gas	0.0018
Naphtha	0.1568
ATK	0.7582
Heavy Kerosene	0.0800
Total Product	1.0137

Table 7.28 Kerosene Hydrodesulfurization (HDS) Unit Utility Consumption per Ton Feed [11].

Utility	Units	Consumption
Fuel	mmBtu	1.7
Power	kW/hr	15
Steam	mmBtu	0.03
Cooling Water	MIG	0.48
Distilled Water	MIG	0.0034

7.22 Atmospheric Residue Desulfurization

Long or atmospheric residue from the CDU can also be desulfurized to remove the metals and reduce the sulfur content to a lower permissible level. Middle East atmospheric residue has a sulfur content of 4–5 wt% and

Table 7.29 Typical Specifications of Dual-Purpose Kerosene (DPK) [11].

Acidity, Total	mg KOH/gm	Max.	0.015	ASTM D3242
Aniline Gravity Product		Min.	4800	ASTM D611
Or				
Net Specific Energy	J/gm	Min.	42800	ASTM D240
Aromatics	vol %	Max.	22	ASTM D1319
Color Saybolt		Min.	+25	ASTM D156
Corrosion Cu Strip				ASTM D130
2 hours, 100 °C		Max.	No.1	
Corrosion Silver Strip				IP 227
4 hours, 50 °C		Max.	No. 1	
Density, 15 °C	kg/liter	Min.	0.775	
		Max.	0.83	
Distillation				ASTM D86
IBP	°C	Min.	145	
10 % Recovered	°C	Max.	205	
95 % Recovered	°C	Max.	275	
EP	°C	Max.	300	
Flash point, ABEL	°C	Min.	40	IP 170
Freezing Point	°C	Max.	-47	ASTM D2386
Hydrogen Content	wt %	Min.	13.8	ASTM D3701
Mercaptan Sulfur	wt %	Max.	0.003	ASTM D3227
Naphthenes	vol %	Max.	3	ASTM D1840
Olefins	vol %	Max.	5	ASTM 1319
Smoke Point	mm.	Min.	23	IP 27
Sulfur	wt %	Max.	0.04	ASTM 1266
Thermal Stability				ASTM D3241
Filter Pressure				
Differential	mm Hg	Max.	25	
Tube Deposit Rating				
Visual		Max.	<3	
Kinematic viscosity at -20 °C	cSt	Max.	8	ASTM D445
Water Reaction				ASTM 1094
Interface Rating		Max.	1b	
Separation Rating		Max.	2	

IBP = Initial Boiling Point; EP = End Point

metals (Ni + V) of 75–90 wppm. The sulfur content can be reduced to less than 0.5 wt %. The feed is introduced into the heater where steam is injected to prevent coking and to a temperature below 700 °F (371 °C). The heated recycled hydrogen is mixed with feed and is introduced into a guard reactor, which contains a hydrogenation catalyst similar to that in the main reactor. The guard

reactor is the first reaction vessel and contains 8% of the total catalyst used in the process. Its function is to remove sodium and other fouling material from the feed and to minimize plugging in the main reactors. The reactants leaving the guard chamber are quenched with cold recycled gas. The quenched mixture then flows into the first main reactor. The guard chamber catalyst is

the same as in the main reactors. There are three main reactors in series, in which all reactors are of the same size and one bed of catalyst. The flow through the reactors is downward; as the desulfurization reaction is exothermic, cold recycle gas is injected between the reactors to control the inlet temperature to each succeeding reactor. Scale baskets and liquid distribution trays are provided in each reactor. Additionally, layers of size-graded catalyst are installed in the top of each reactor.

The catalyst has wide pores to avoid plugging due to metal deposition. In the reactor, organ-metallic compounds are hydrogenated and the metals are deposited. Salts from the crude desalters are also removed. Two reactors are used as one is in operation while the catalyst is changed in the other due to the fast deactivation of the catalyst. Desulfurization, denitrification and hydrodemetallization reactions are taking place under severe conditions, and thus three to four reactors are used with different combinations of catalysts to achieve the desired specifications of the products.

The steam leaving the guard reactor is quenched with cold recycle hydrogen and introduced to the first of the three fixed-bed reactors. The main reactions of hydrodemetallization, hydrodesulfurization, denitrification and aromatic hydrogenation take place in these reactors.

7.22.1 High-Pressure Separator

The effluent from the last reactor flows to high-pressure hot separator, where the necessary separation takes place between the desulfurized liquid product and recycled gas. Vapor from HP hot separator is cooled to 500 °F (260 °C) by heat exchange with recycled gas. The cooled partially condensed HP hot separator vapors are fed to HP warm separator, where asphaltenes that may be entrained in the vapor leaving the HP hot separator are removed. If the asphaltenes are not removed, an oil/water emulsion may form when water and oil condense in the high-pressure loop. The HP warm separator operates at 500 °F (260 °C), which is well above the dew point of water at 300 °F (149 °C).

Liquid from the HP warm separator is combined with liquid from the HP hot separator and let down in pressure through a power recovery turbine. Vapor from the HP warm separator is cooled to 105 °F (66 °C) by heat exchange with recycled gas by an air-cooler and finally by water cooler. The partially condensed HP warm separator vapor at 105 °F (66 °C) feeds HP cold separator. The final separation between the liquid and

recycled gas is made in this vessel. The condensed water is removed, and water and oil are separated here, where both of these streams flow to the low-pressure LP cold separator. The separation of oil and water in the HP cold separator is required to avoid emulsification of an oil/water mixture across the pressure let-down valve in the line to the low-pressure cold separator.

7.22.2 Low-Pressure Separator

Liquids from high-pressure hot and warm separators after let-down in pressure are fed to the low-pressure hot separator, as the flashed mixture is separated in this vessel. The liquid from the LP hot separator flows directly to the fractionator feed heater. Flashed vapor from the LP hot separator is partially condensed by heat exchange and flows to LP cold separator. The feeds to LP cold separator consist of separated oil and water streams from HP cold separator. LP cold separator off-gas is sent to the hydrocarbon recovery system. Water from the LP cold separator is sent to sour water stripping unit. The liquid stream from the separators is pumped to a fractionator to produce naphtha, diesel, and low-sulfur fuel oil (LSFO).

7.22.3 Hydrogen Sulfide Removal

The vapor from the high-pressure cold separator flows through the recycle gas filter, where the entrained oil and scale are removed to prevent foaming in the amine system. The vapor flows to H₂S absorption column where it is contact with a lean amine solution. The rich amine solution goes to a regeneration unit.

7.22.4 Recycled Gas Compressor

The absorbed recycled gas is sent to recycle gas compressor, driven by a steam turbine. The compressed recycled gas is combined with makeup hydrogen and split into two streams. One stream is heated in the recycled gas preheater by heat exchange with HP warm separator and hot separator off-gases and finally in recycled gas heater. The other stream is recycled gas from the compressor and is used to quench the effluent from each reactor before entering the next reactor.

7.22.5 Process Water

Water is used to increase the activity of the catalyst and to prevent the deposit of solids in the reactor effluent

cooler. Water is also used to wash recycled gas before and after the amine wash. Water used to increase catalyst activity is added to the resid charge upstream of the charge heater and called injection water.

7.22.6 Fractionation Column

The fractionation section is to separate the desulfurized liquid stream from hot and cold low-pressure separators into the following products:

1. An overhead hydrogen-rich vapor to be processed in the gas handling plant.
2. A stabilized naphtha stream for processing in naphtha hydrotreater.
3. A distillate side cut product with an ASTM end point of 735 °F (391 °C).
4. A 680 plus bottom product.

The fractionating column has ~ 26 trays. The heated resid feed enters the column on tray No. 6, and a small amount of the distillate from the low-pressure cold separator enters the column on tray No. 10. A stripping steam is introduced below the bottom tray to strip the material boiling below 680 °F (360 °C) from the column.

The ARDS unit reactor temperature is increased at the end of the run (EOR) to burn off any deposited carbon,

where thermal cracking occurs at these temperatures. Figure 7.39 shows a schematic of atmospheric residue desulfurization process and Figure 7.40 is a photograph of heavy gas oil hydrodesulfurizer reactor with feed/effluent shell and tube heat exchangers. Tables 7.30 and 7.31 show ARDS feed and product properties and yields.

7.22.7 Operating Conditions of Hydrotreating Processes

The operating conditions include temperature, pressure, feed flow rate, hydrogen partial pressure and catalyst loading. The hydrogen partial pressure must be greater than the hydrocarbon partial pressure, as this is caused by high pressure and high hydrogen flow rate (make-up and recycle). Increasing hydrogen partial pressure improves the removal of sulfur and nitrogen compounds and reduces coke formation.

An increase in the reaction rate constant and an improvement in the kinetics are caused by high temperatures, but excessive temperatures can result in thermal cracking and coke formation. The space velocity (SV) is the inverse of the residence time; a high SV (low residence time) results in low conversion, low hydrogen consumption and low coke formation.

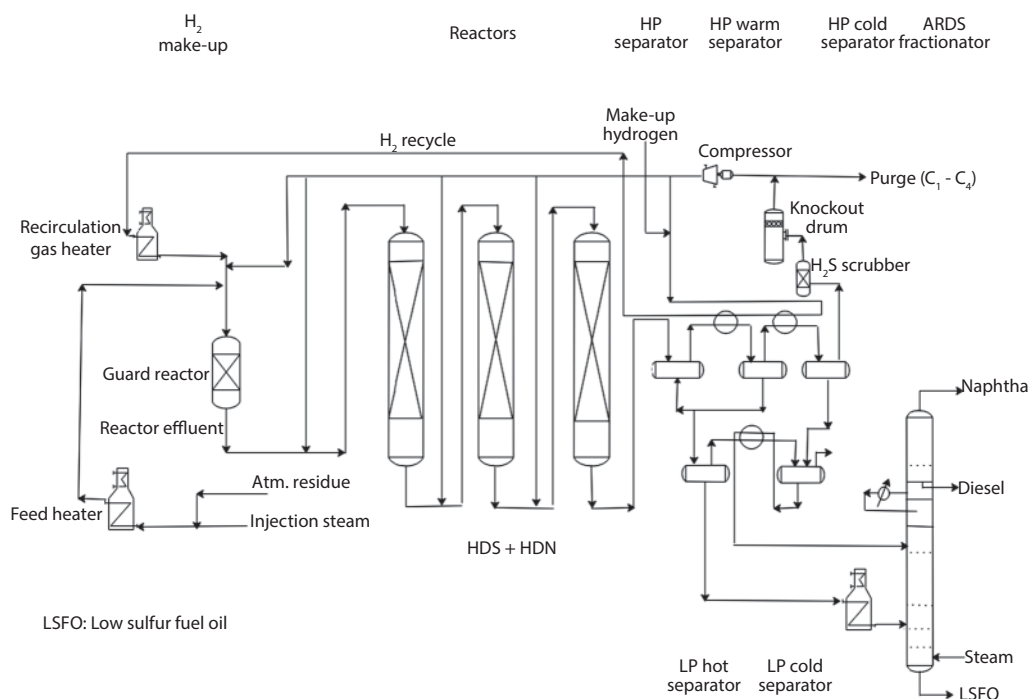


Figure 7.39 Atmospheric residue desulfurization process.



Figure 7.40 Heavy gas oil hydrodesulfurizer reactor with feed/effluent shell and tube heat exchangers.

Table 7.30 Typical Atmospheric Residue Desulfurization (ARDS) feed and product properties.

	Feed	Naphtha	Diesel	LSFO
TBP cut point (°F)	680	C ₅ -320	320-680	680
API gravity	13.2	52.5	33.5	22.7
Sulfur (wt %)	4.2	0.1	0.05	0.5
Nitrogen (wt %)	0.26	-	0.02	0.13
Metal (Ni + V) (wppm)	75-90	-	-	28

Table 7.31 Typical Atmospheric Residue Desulfurization (ARDS) yields.

	Weight fraction
Feed	
Atmospheric Residue	1
Hydrogen	0.016
Total input	1.016
Products	
Acid gases	0.038
C ₁ - C ₄	0.02
Naphtha	0.027
Diesel	0.186
LSFO	0.745
Total input	1.016

Table 7.32 shows operating conditions of hydrotreating of different feed fractions.

A Case Study [1]

A heavy residue stream that contains mostly n-C₃₀ (990 lb mol/h) and some amount of thiophene (10 lb mol/h) is prepared to enter an atmospheric residue desulfurization process to crack the heavy component n-C₃₀ to more lighter components such as n-C₂₀, n-C₁₀ and n-C₄. Additionally, thiophenes should be completely removed. The feed stream is initially at 100 °F and 120 psia. This feed requires to be mixed with hydrogen stream (1250 lb mol/h) available at 150 °F and 200 psia. The mixed feed should be heated and compressed to 700 °F and 1500 psia before entering the reactor. The reactions are shown in Table 7.33.

The reactor products are cooled to 200 °F before entering a gas-liquid separator, 300 lb mol/h of the hydrogen coming from this separator is recycled back with the feed. The rest is vented to the atmosphere. The liquid stream coming out from the separator is then expanded by a valve to reduce the pressure to 250 psia. This makes it ready to enter a distillation column in order to separate the extra hydrogen left with the hydrocarbons. A typical flowsheet of the ARDS process is shown in Figure 7.41. Perform a material and energy balance for the ARDS process using UniSim simulator.

Solution

The schematic of the hydrocracking process is shown in Figure 7.41, and UniSim Honeywell simulation package was used to perform the mass and energy balance for the hydrocracking process. The process flow diagram from Honeywell Process Solution is shown in Figure 7.42. The procedure involves the following.

1. To start a new case, select **File/New/Case** or press **Ctrl+N** or click on the **New Case**. This will open up the **Simulation Basis Manager** in UniSim.
2. To add components to the simulation, click on the **Add** button in the Simulation Basis Manager. Clicking on **Add** will bring up the **Component List View** which is a list of all the components available in UniSim.
3. Select the desired components as shown in Table 7.34 for the simulation. This can be searched through the list of components in one of three ways:
 - Sim Name

Table 7.32 Process parameters for hydrotreating different feedstocks [18].

Feedstock	Naphtha	Kerosene	Gas oil	Vacuum gas oil	Residue
Boiling range, °C	70–180	160–240	230–350	350–550	> 550
Operating temperature, °C	260–300	300–340	320–350	360–380	360–380
Hydrogen pressure, bar	5–10	15–30	15–40	40–70	120–160
Hydrogen consumption, wt%	4–10	2–4	1–3	1–2	0.15–0.3
LHSV, hr ⁻¹	4–10	2–4	1–3	1–2	0.15–0.3
H ₂ /HC ratio, std m ³ /m ³	36–48	36–48	36–48	36–48	12–24

Table 7.33 Typical reactions in atmospheric residue desulfurization.

Rxn #	Reaction	Reactor type	Conversion
1.	$C_4H_4S + 4H_2 \rightarrow C_4H_{10} + H_2S$	Conversion	100%
2.	$C_{30}H_{62} + H_2 \rightarrow C_{20}H_{42} + C_{10}H_{22}$	Conversion	70%

- Full Name
 - Formula
4. Once you have located the desired component, either double click on the component or click ←--- Add Pure to add it to the list of components for the simulation.
 5. From the simulation basis manager, select the **Fluid Pkgs** tab.
 6. Click the **Add** button to create a new fluid package
 7. From the list of fluid packages, select the desired thermodynamic package. The list of available packages can be narrowed by selecting a filter to the left of the list (such as EOSs, activity models etc.)
 8. Once the desired model has been located, select it by clicking on it once. In this case study, select **Peng-Robinson** property package for the simulation.
 9. Click on Reactions tab in the Simulation Basis Manager window and Insert Reaction – 1 stoichiometry and conversion; do the same for the subsequent Reaction –2, as shown above.
 10. After the reaction set has been created, it must be added to the current fluid package in order for UniSim to use them.
 1. Highlight the desired Reaction Set and Press **Add to FP**.
 2. Select the only available Fluid Package and press the **Add Set** to the **Fluid Package** button.
 11. Once the reaction set is added to the Fluid Package, Click **Return to the Simulation Environment** and begin construction of the simulation. Make sure the **Solver** is active.
 12. To set the units, Click on the **Tools** menu and select **Preferences**. Then click on the **Variables** tab in the Session Preferences window. This displays **Available Unit Set**. e.g., NewUser, SI, etc. Click on the required unit for the simulation.
 13. Insert the first unit for the oil feed as shown in the flow chart with compositions, temperature and pressure.
 14. Continue inserting the units as shown in the chart.
 15. From the Object Palette, click **General Reactors** and select the **Conversion Reactor**. Enter it into the PFD of the UniSim Simulation Environment window.
 16. The distillation column is 15 trays with reflux ratio equal to 1.0 and full reflux. The active specification to run the distillation column is a hydrogen recovery of 100% and an n-decane C₁₀ recovery of 90%.
 17. Table 7.34 lists summary of the results.

Figure 7.42 shows a snapshot of the simulation using UniSim process simulator. Figures 7.43 and 7.44 show the temperature and pressure vs. tray position profiles of the ARDS simulation respectively and Table 7.34 shows a summary of the results. The simulation program (**ARDS.usc**) can be accessed from Scrivener dedicated web site of this text.

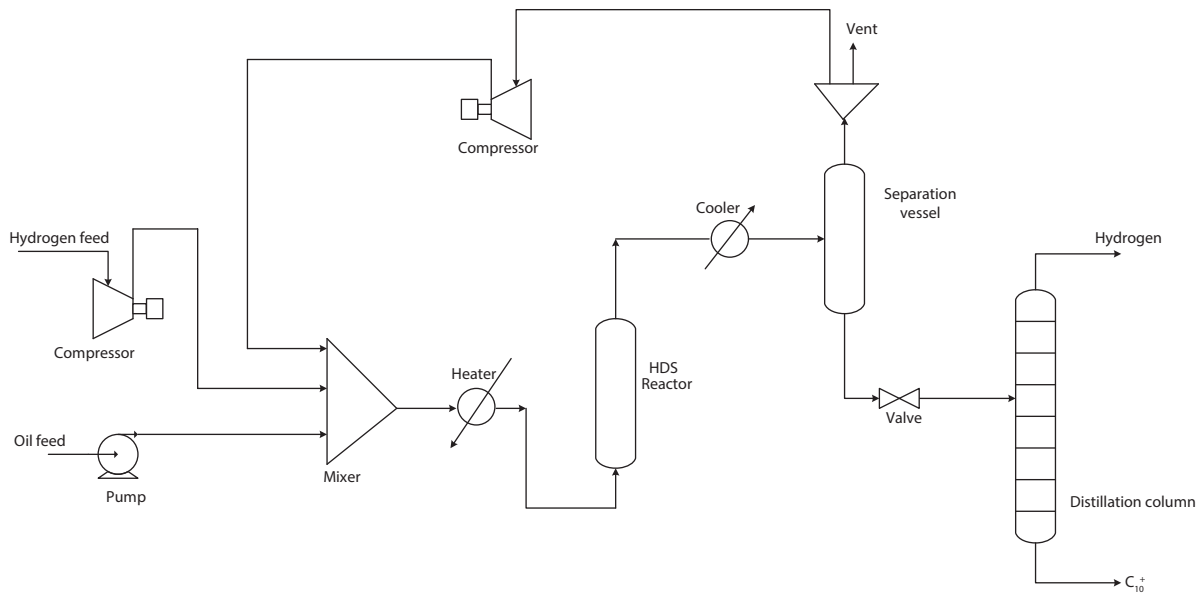


Figure 7.41 Schematic of Atmospheric residue desulfurization (ARDS) process.

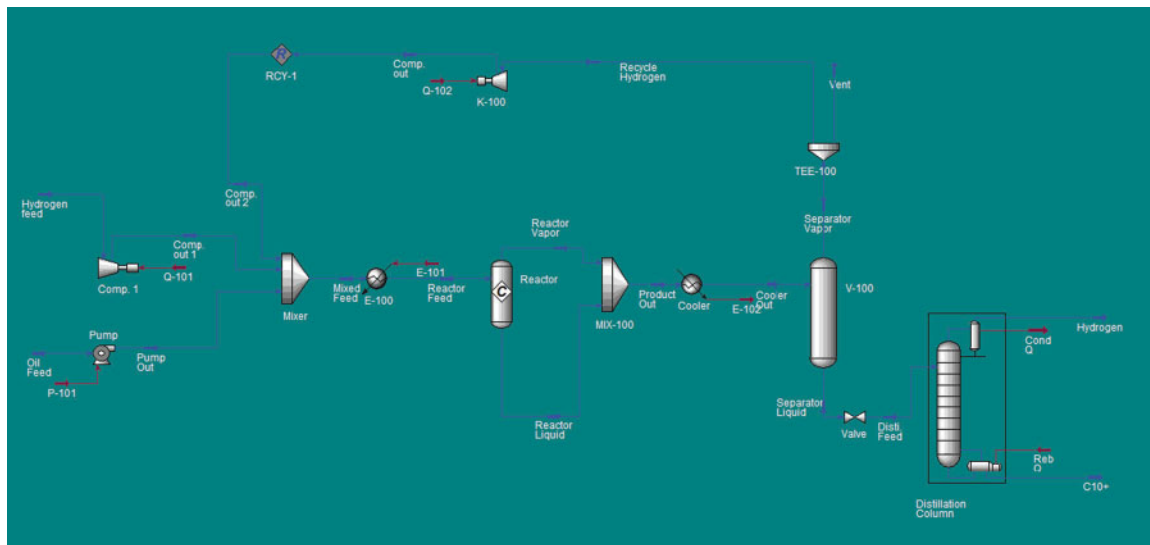


Figure 7.42 A snapshot of process flow diagram of ARDS simulation (Courtesy of Honeywell Process Solution, UniSim Design R433), Honeywell (R) and UniSim (R) are registered trademarks of Honeywell International Inc.)

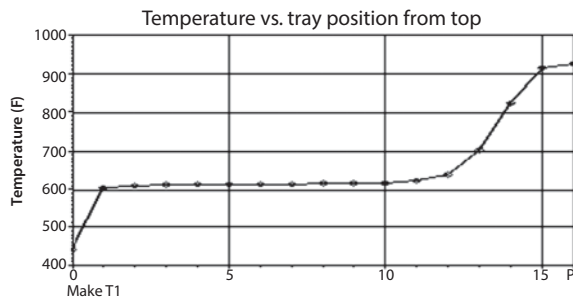


Figure 7.43 Profile of Temperature vs. Tray position of the distillation column of ARDS simulation (Courtesy of Honeywell Process Solution, UniSim Design R433).

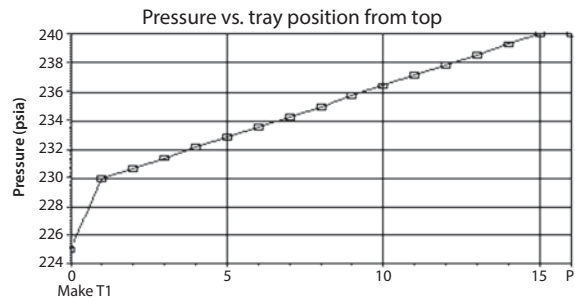


Figure 7.44 Pressure vs. Tray position of the distillation column of ARDS simulation of ARDS simulation (Courtesy of Honeywell Process Solution, UniSim Design R433).

Table 7.34 UniSim results of ARDS simulation.

Stream name	Hydrogen feed	Comp. out 1	Oil feed	Pump out	Comp. out 2	Mixed feed	Reactor feed	Reactor vapor	Reactor liquid	Product	Cooler out	Separator vapor	Separator liquid	Vent	Recycle hydrogen	Dist. feed	Hydrogen	C ₁₀ ⁺
Temperature, °F	150	790.2	100	101.5	200.7	126.3	700	756.6	756.5	765.5	200	200	200	200	200	209	443	929
Pressure, psia	200	1500	120	1500	1500	1500	1498	1498	1498	1498	1496	1496	1496	1496	1496	250	225	240
Total molar flow (lb mol/h)	1250	1250	1000	1000	300	2550	2550	200.9	2319	2520	2520	635.7	1884	335.7	300	1884	271	1613
Thiophene (lb mol/h)	0	0	10	10	0	10	10	0	0	0	0	0	0	0	0	0	0	0
H ₂ S (lb mol/h)	0	0	0	0	1	1	1	1.4	9.6	11	11	2	9	1	1	9	9	0
H ₂ (lb mol/h)	1250	1250	0	0	299	1549	1549	163.5	652.1	815.6	815.6	632.8	182.9	334.1	298.6	182.9	182.9	0
n-C ₃₀ (lb mol/h)	0	0	990	900	0	990	990	0.8	296.3	297	297	0	297	0	0	297	0	297
n-C ₂₀ (lb mol/h)	0	0	0	0	0	0	0	6.9	686.1	693	693	0	693	0	0	693	0	693
n-C ₁₀ (lb mol/h)	0	0	0	0	0	0	0	27.3	665.9	693.2	693.2	0.3	692.8	0.2	0.2	693	69.5	623
n-C ₄ (lb mol/h)	0	0	0	0	0	0	0	1	9.3	10.3	10.3	0.6	9.7	0.3	0.3	10	10	0

7.23 Health, Safety and Environment Considerations

Fire Prevention and Protection: Hydrotreating unit operates at high temperatures and pressures; therefore, control of both hydrocarbon leaks and hydrogen releases is important to prevent fires. In some processes, care is required to ensure that explosive concentrations of catalytic dust do not form during recharging.

Safety: Inspection and testing of safety relief devices are important due to the very high pressures in this unit. Proper process control is essential to protect against plugging reactor beds. Unloading coked catalyst requires special precautions to prevent iron-sulfide fires. The coked catalyst should either be cooled to below 120 °F (49 °C) before dumping or be placed in nitrogen-inserted containers until cooled.

Because of the operating temperatures and in the presence of hydrogen, the hydrogen-sulfide (H₂S) content of the feedstock must be strictly controlled to a minimum to reduce the possibility of severe corrosion. Corrosion of wet carbon dioxide (CO₂) in areas of condensation also must be considered. When processing high-nitrogen feedstock, the ammonia (NH₃) and hydrogen sulfide (H₂S) form ammonium hydrosulfide (NH₃)HS, which causes serious corrosion at temperatures below the water dew point. Ammonium hydrosulfide is also present in sour water stripping.

Health: Since this is a closed process, exposures are expected to be minimal under normal operating conditions. However, there is potential for exposure to hydrocarbon gas and vapor emissions, hydrogen and hydrogen sulfide gas due to high-pressure leaks. Large quantities of carbon monoxide may be released during catalyst regeneration and changeover. Catalyst steam stripping and regeneration create waste streams containing sour water and ammonia. Safe work practices and the use of appropriate personal protective equipment may be required for exposure to chemicals and other hazards such as noise and heat, during process sampling, inspection, maintenance, and turnaround activities, and when handling spent catalyst.

References

1. Fahim, M. A., Al-Shahaf, T. A., and A. S. Elkilani, *Fundamentals of Petroleum Refining*, Elsevier, 2010.
2. Nelson, W. L., *Oil & Gas J.*, 71 (44), p 108, 1973

3. Secherzer, J., and A. J. Gruia, *Hydrocracking Science and Technology*, Marcel Dekker, New York, 1996.
4. Billon, A., and P. H. Bigeard, Hydrocracking, Chapter 10, In *Conversion Processes Petroleum Refining*, Vol. 3, Leprince, P., ed., TECHNIP, France, 2001.
5. Gary, James, H., Handwerk, Glenn, E. and Mark, J. Kaiser, *Petroleum Refining – Technology and Economics*, 5th ed., CRC Press Taylor & Francis Group, 2007.
6. Nelson, W. L., *Oil & Gas J.*, 65 (26), pp 84–85, 1967.
7. Nelson, W. L., *Oil & Gas J.*, 65 (26), pp 84–85, 1971.
8. Hougen, D. A. and K. M. Watson, *Industrial Chemical Calculations*, John Wiley & Sons, New York, 1938.
9. Pedersen, B. S., Elkwall, G. R., Gruia, A. J., Humbach, M. J, Kauff, D. A., and Meurling, P. J., UOP Technology Conference, 1990.
10. Yui, S. M., and E. C. Sanford, “Kinetics of aromatics hydrogenation and prediction of cetane number of synthetic distillates”, *Proceedings – Refining Dept., 50th Mid year Meeting (Kansas City), MO*, pp 290–297, May 1985.
11. Parkash, Surinder, *Refining Processes Handbook*, Gulf Publishing Co., Elsevier, 2003.
12. Ali, S. A. Chapter 4: Thermodynamics of hydroprocessing reactions, Inc. *Hydroprocessing of Heavy Oil and Residua*, Ancheyta, J., Speight, J.G. (eds), CRC Press, Taylor & Francis, New York, 2007.
13. Tarhan, O. M., *Catalytic Reactor Design*, McGraw-Hill, New York, 1983.
14. Ancheyta, Jorge, *Modeling and Simulation of Catalytic Reactors for Petroleum Refining*, John Wiley & Sons, Inc., New Jersey, 2011.
15. Maples, R. E., *Petroleum Refining Process Economics*, PennWell Books, Tulsa, OK, 1993.
16. Cutlip, M. B., and M. Shacham, *Problem Solving in Chemical Engineering with numerical Methods*, Prentice-Hall, Int., 1999.
17. Fogler, H. Scott, *Elements of Chemical Reaction Engineering*, 4th ed., Prentice Hall, 2006.
18. Heinrich, G., and Kasztelan, S., “Hydrotreating”, Chapter 16, In *Conversion Processes, Petroleum Refining*, vol. 3, Leprince, P, ed., TECHNIP, France, 2001.
19. Martyn, V., Twigg, *Catalyst Handbook*, 2nd ed., Manson Publishing Ltd., 1996.
20. Coker, A.K., *Modeling of Chemical Kinetics and Reactor Design*, Gulf Publishing Co., 2001.
21. Handley, D and P.J. Heggs, *Trans. Instn. Chem. Engr.*, 46 – T251, 1968.
22. McDonald, I.F., El-Sayed, M.S., Mow, K., and F. A. L. Dullien, *Ind. Eng., Chem. Fund.*, 18, 199, 1979.
23. Hicks, R. E., *Ind. Eng. Chem. Fund.*, 9, 500, 1970.
24. Wentz, G. A. and G. Thodos, *AIChEJ.* 9, 81, 1963.
25. Tallmadge, J. A., *AIChEJ.* 16, 1092, 1970.
26. Perry, R., and D. Green, *Perry's Chemical Engineering Handbook*, 6th ed., pp 5–54, McGraw-Hill Int., ed., 1984.

8

Catalytic Cracking

8.1 Introduction

The most important and widely used refinery process for converting heavy oils into more valuable gasoline and lighter products is catalytic cracking process. There are more than 10.6 MMBPD (over 1 million tons/day) of oil processed worldwide. Fluid catalytic cracking (FCC) naphtha provides 35–45% of the blending stocks in refinery gasoline blending pools. As we discussed in an earlier chapter, cracking was accomplished thermally, but the catalytic process has almost completely replaced thermal cracking because more gasoline has higher octane, and fewer heavy fuel oils and light gases are produced. It has been shown that the light gases produced by catalytic cracking contain more olefins than those produced by thermal cracking (Table 8.1).

The cracking process produces coke that remains on the surface of the catalyst particle, and invariably reduces its activity. Therefore, to maintain the catalyst activity at a useful level, it is necessary to burn off this coke with air by regenerating the catalyst. As a result, the catalyst is continuously removed from the reactor to the regenerator and then returned to the reactor. The cracking reaction is endothermic (i.e., absorbing heat), and the regeneration reaction is exothermic (i.e.,

releasing heat). Some units are designed to use the regeneration heat to supply that required for the reaction and to heat the feed up to the reaction temperature. The average riser reactor temperatures are in the range 900–1050 °F (480–566 °C) with oil feed temperatures from 500–800 °F (260–425 °C) and regenerator exit temperatures for the catalyst from 1200–1500 °F (650–815 °C). There are various types of cracking processes, namely: fixed-bed and fluidized-bed units. There are modifications for these units depending upon the designer; however, the basic operation is very similar. For a fixed-bed unit, the Thermafor catalytic cracking (TCC) process is a representative; while the fluid catalytic cracking unit (FCC) is representative of the fluidized bed units. This unit can be classified as either bed or riser (transfer line) cracking units depending upon where the major fraction of the cracking reaction occurs. Recently, almost all the FCCs have been designed to operate with riser cracking. There are two different configurations for FCCs. One is the stacked type (Figure 8.1a) where the reactor, and the catalyst regenerator are contained in a single vessel with the reactor above the catalyst regenerator and the “side-by-side” (Figure 8.1b) type where the reactor and catalyst regenerator are in two separate vessels.

Table 8.1 Thermal vs. catalytic yields on similar topped crude feed [1].

	Thermal cracking		catalytic cracking	
	wt %	vol %	wt %	vol %
Fresh feed	100.0	100.0	100.0	100.0
Gas	6.6		4.3	
Propane	2.1	3.7	1.3	2.2
Propylene	1.0	1.8	6.8	10.9
Isobutane	0.8	1.3	2.6	4.0
n-butane	1.9	2.9	0.9	1.4
Butylene	1.8	2.6	6.5	10.4
C ₅ + gasoline	26.9	32.1	48.9	59.0
Light cycle oil	1.9	1.9	15.7	15.0
Decant oil			8.0	7.0
Residual oil	57.0	52.0		
Coke	0		5.0	
Total	100.0	96.5	100.0	100.9

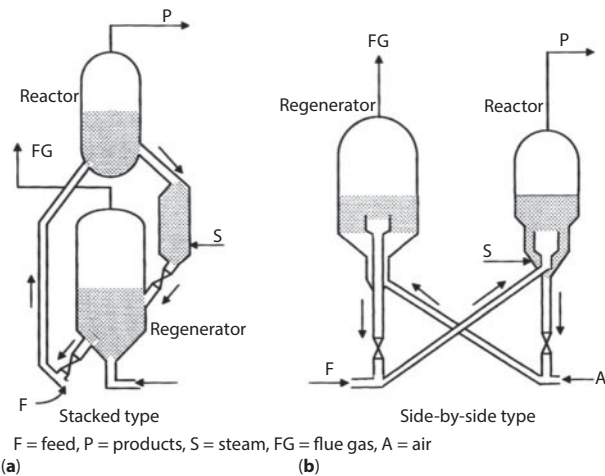


Figure 8.1 FCC type configurations.

The feedstocks to the FCC are primarily in the heavy vacuum gas oil range; boiling ranges are 640 °F (338 °C) (10%) to 980 °F (527 °C) (90%), and typical feedstock properties are shown in Table 8.2. The gas oil is limited in end point by maximum tolerable metals, although the new zeolite catalysts have demonstrated higher metals tolerance than the older silica-alumina catalyst. The process has considerable flexibility; apart from processing the more conventional waxy distillates to produce gasoline and other fuel components, feedstocks ranging from naphtha to a suitably pre-treated residuum are successfully processed to meet specific product requirements.

Table 8.2 Feedstock properties of FCC unit [7].

	Desulfurized vacuum gas oil	Atmospheric residue
Specific gravity (15/4 °C)	0.896	0.889
API	26.3	27.5
Gas oil fraction (GO), wt % (boiling point < 343 °C)	7	4
VGO fraction (VGO), wt % (boiling point 343–538 °C)	88.5	52.5
Vacuum residue fraction (VR), wt % (boiling point > 538 °C)	4.5	43.5
Conradson Carbon Residue (CCR), wt % Sulfur, wt%	0.2	4.2
Sulfur, wt%	0.4	0.11
Nitrogen, wt%	0.064	0.19
Nickel (Ni), wppm	0.26	17
Vanadium (V), wppm	0.15	0.5

Figure 8.2 shows a block diagram of how the fluid catalytic cracking unit plays a central role in refining operation. FCC units are preceded by basic separation processes such as atmospheric and vacuum distillation units, catalytic reacting processes such as hydrotreatment; minor additional units, pumps, stabilization towers, etc. Downstream, FCC units supply products, mainly to the gasoline pool, but also to other units that require light hydrocarbons. Finally, when there is a high level of sulfur in the gasoline, FCC units supply feedstock for hydrodesulfurization processes. Therefore, FCC units interact very little with downstream processes and some with upstream processes.

The feedstocks can be hydrotreated vacuum gas oil (VGO), and atmospheric residue desulfurized (ARDS) oil. More recently vacuum residues are desulfurized and then used as the feed. The FCC takes the heavy desulfurized feedstock and cracks it into lighter, mainly high octane gasoline. In a typical refinery, FCC is used mainly to produce gasoline. It also produces olefins (C₄ and C₅) and LPG. Olefins can be employed for alkylation and for petrochemical production of a

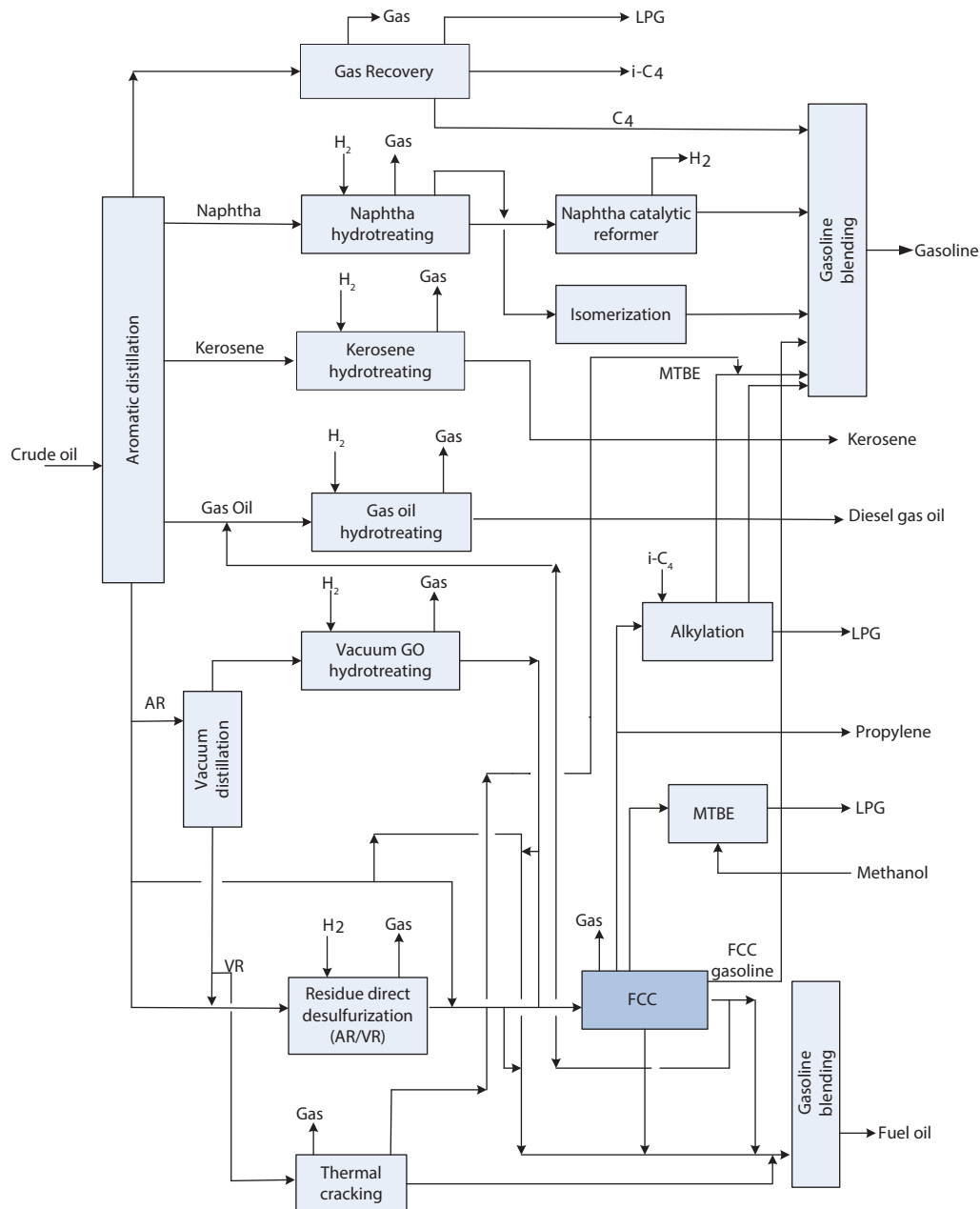


Figure 8.2 Role of fluid catalytic cracking in refining operation.

high-octane oxygenated methyl tertiary butyl ether (MTBE). MTBE is formed by catalytic etherification of isobutylene with methanol. MTBE and other tertiary alkyl ethers are primarily used in gasoline blending as an octane enhancer to improve the hydrocarbon combustion efficiency. However, MTBE which has a Research Octane Number of 118 is now excluded as an enhancer when governments mandated minimum oxygen content in gasoline to enable more complete combustion and reduce emissions of volatile organic compounds. It has also been found that MTBE pollutes

aquifers as it is miscible with water; it has an unpleasant smell, taste and carcinogenic.

In a typical FCC unit, the cracking reactions are carried out in a vertical reactor referred to as a riser in which liquid oil stream contacts the hot powdered catalyst. The oil vaporizes and cracks to lighter products as it moves up the riser and carries the catalyst powder along with it. The reactions are rapid, and only a few seconds of residence time are necessary in most applications. With the desired reactions, coke, a carbonaceous material having a low ratio of hydrogen

to carbon (H/C), deposits on the catalyst and thus renders it less active. The spent catalyst and the converted products are then separated, and the catalyst passes to a separate chamber, the regenerator, where the coke is combusted to rejuvenate the catalyst. This is then sent to the bottom of the riser where the cycle is repeated.

Figure 8.3 shows a schematic of FCC unit, where the objective is to convert low value gas oils to valuable products such as naphtha, diesel and slurry oils. The primary technique involves catalytic cracking, which increases H/C ratio by carbon rejection in a continuous process. The gas oil feed is dispersed into the bottom of the riser using steam where thermal cracking occurs on the surface of the catalyst. Disengaging drum separates spent catalyst from the product vapors, and steam strips the residue hydrocarbons from the spent catalyst. Air is introduced to burn away the carbon film from the catalyst in either a partial burn or full-burn mode of operation, and the regenerated catalyst enters the bottom of the riser-reactor.

The products from the FCC converter are classified as a mixture from dry gas (DG) up to heavy cycle oil (HCO). This blend is separated by the boiling point (atmospheric pressure) in a fractionator followed by a vapor recovery unit. The main fractionator sends heavy products to a non-isothermal decanter, where cycle oils are separated into light (LCO) and heavy (HCO). Top products are compressed and cooled down to separate those that are condensable; these are stabilized (debutanized) in order to obtain gasoline and to separate liquefied petroleum gas (LPG) plus dry gas (DG). Finally, LPG and DG are separated by condensation, sending DG as a fuel to the rest of the refinery. The products from the disengaging vessel are fed to a distillation column where they are separated.

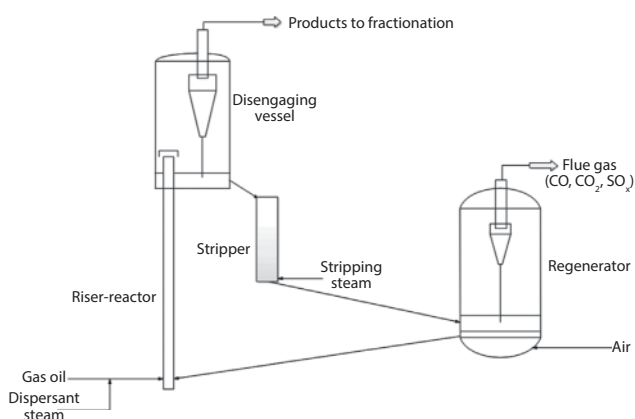


Figure 8.3 Schematic of FCC unit.

Common Yields and Product Quality

The most important product from the FCC unit is gasoline and its yield ranges from 46–51 wt% for standard feedstock, which could increase to ~60 wt% for hydrotreated feedstock. Quality parameters for gasoline are motor octane number (MON), research octane number (RON), and anti-knocking index [AKI = (RON + MON)/2], which is related with the content of paraffins, olefins, naphthenes and aromatics. When this classification was proposed, it was considered that a perfect gasoline should exhibit AKI = 100, which corresponds to pure 2, 2, 4-trimethylpentane (i.e., isooctane, $i\text{-C}_8\text{H}_{18}$) and the zero point is n-heptane ($n\text{C}_7\text{H}_{16}$). The second commercial product is LPG, especially if the FCC unit supplies it to downstream processes. LPG yield is ~12–15 wt%, dry gas (~5wt%), LCO (~15 wt%), and HCO (~8 wt%). It is possible to incorporate LCO in diesel fuel, but it requires hydro-treatment to decrease the sulfur and aromatic contents. Finally, ~4–6 wt% of the original feedstock converts to coke, which is a solid that forms on the catalyst surface, blocking the pores and consequently decreasing the catalyst activity. These yields are dependent upon the feedstock types, (i.e., from heavy to hydrotreated) and the production objectives of the catalyst. Table 8.3 shows products and yields and corresponding characteristics of FCC process.

8.2 Fluidized Bed Catalytic Cracking

8.2.1 Process Description

The principle in the fluid cracking process is that finely divided powders behave like a fluid when aerated with a gas. A bed of cracking catalyst of 60–70 average particle size undergoes fluidization at upward gas velocities of 60–100 cm/s, which acts like a fluid density of 400–650 kg/m³. In this state, catalyst can easily move through pipes and from one vessel to another. As the velocity of the gas increases, the finer catalyst particles get elutriated from the bed and at velocities of 3 m/s., the gas stream transports the entire catalyst. The catalyst circulation rate is maintained in such a way that it is 5–8 times greater than the feed rate. In order to make the catalyst flow in the desired direction, around 0.35 atm positive-pressure differential has to be maintained across the catalyst control valves.

The feedstock to an FCC unit is usually a heavy distillate boiling within the range 662–932 °F (350–500 °C)

Table 8.3 Typical products of FCC.

Products	Characteristics	Yield (wt %)
Dry gas + H ₂ S (C ₁ + C ₂ + C ₃ + H ₂) + H ₂ S	H ₂ S must be removed	3–5
LPG: C ₃ , C ₃ ⁼ , C ₄ , C ₄ ⁼	Petrochemical feedstock	8–20
Gasoline	Main product, good octane number	35–60
Light cycle oil (LCO)	Rich in aromatics, high sulfur content, diluent for fuel	12–20
Heavy cycle oil (HCO + slurry)	Very rich in aromatics, slurry of solids, (mainly catalyst coke)	10–15
Coke	Consumed in regenerator	3–5

obtained by the distillation of reduced crude under vacuum. The cracking of a feedstock is inversely proportional with the concentration of aromatic carbon atoms. In general, the highly paraffinic feedstock having a Watson characterization factor $K_w = 12.0$ gives the maximum gasoline yield; naphthenic feedstocks having K_w values between 11.5–11.6 give intermediate yields and the highly aromatic feedstock of $K_w = 11.3$ gives the very poor yields.

Figure 8.4 shows a typical flow diagram of fluid catalytic cracking unit (FCC). The high-boiling feedstock consisting of long-chain hydrocarbon molecules is preheated between 599–806 °F (315–430 °C). This is combined with recycled slurry oil from the bottom of the distillation column and injected into the catalyst riser of the reactor. It is vaporized and cracked into smaller molecules by contact with hot powdered catalyst recycled from the regenerator. The cracking of the molecules takes place in this section as the upcoming vapors fluidize the powdered catalyst; the mixture of vapors and the catalyst flows upwards to enter the reactor at a temperature of ~ 995 °F (~535 °C) and a pressure of about 1.72 barg.

In the early stages of FCC, the catalyst used was aluminum trichloride (AlCl₃) solution. Later, the catalyst was amorphous silica alumina. It had superior properties as high thermal and attrition stability, high activity and optimal pore structure. Recently, the catalysts are zeolite-based, which are mixtures of crystalline alumina silicates, active alumina, silica-alumina, clay and rare-earth oxides. These catalyst types are more active, more stable, form less coke and have higher acidity. Since zeolite crystals are too active for practical use in the reactors, the zeolite is diluted with porous silica-alumina material. The dilution also has the benefit of increasing the pore diameter, which allows bigger size molecules to enter the pores and be cracked [2].

In the FCC, an oil feed composed of heavy hydrocarbon molecules is mixed with the catalyst and enters a fluidized bed reactor. The long molecules react on the surface of the catalyst and are cracked into lighter products molecules (e.g., gasoline), which leave the reactor from the top. During the cracking process, carbon and other heavy uncracked organic materials are deposited on the surface of the catalyst and very quickly reduce its activity resulting in its deactivation. The catalyst is regenerated in the regenerator by burning coke with air blown into the regenerator. The regenerator operates at a temperature of ~1382 °F (~715 °C) and a pressure of ~35 psig (~2.41 barg) (Figure 8.5a). The regenerated catalyst then moves through a control valve to the base of the riser to complete the cycle. Abrasion-resistant refractory linings are used throughout the reactor/regenerator system to prevent erosion due to the catalyst. The combustion of the coke is exothermic, which produces a large amount of heat that is partially absorbed by the regenerator catalyst, which in turn provides further heat required for the vaporization of the feedstock and the endothermic cracking reactions that take place in the catalyst riser. This makes the FCC system a largely heat-balanced system.

The hot catalyst (at about 1319 °F [715 °C]) leaving the regenerator flows into a catalyst withdrawal well where any entrained combustion flue gases are allowed to escape and flow back into the upper part of the regenerator. The flow of regenerated catalyst to the feedstock injection point below the catalyst riser is regulated by a slide valve in the regenerated catalyst line. The hot flue gas exits the regenerator after passing through multiple sets of two-stage cyclones (Figure 5.5b) that remove the entrained catalyst from the flue gas. The amount of catalyst circulating between the regenerator and the reactor is about 5 kg per kg of feedstock, which is equivalent to ~ 4.66 kg per liter of feedstock. Therefore, the FCC unit that processes

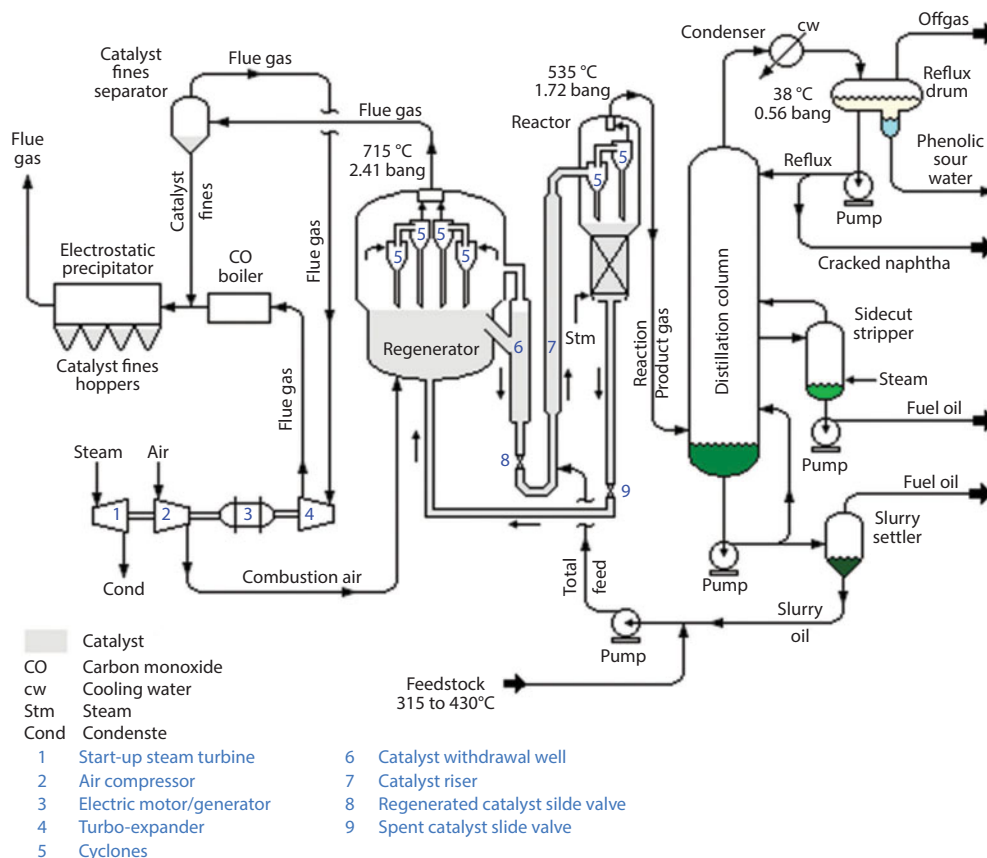


Figure 8.4 A schematic flow diagram of a fluid catalytic cracking unit as used in petroleum refineries. (Source: Mbeychok, : http://en.wikipedia.org/wiki/Fluid_catalytic_cracking)

75,000 barrels per day (11,900 m³/day) will circulate ~ 55,900 tonnes per day of catalyst.

A salient feature of the fluidized bed reactor is that it operates at a nearly constant temperature in the range 896–1004 °F (480–540 °C) to control the degree of conversion, and is therefore, easy to control. Furthermore, there is no opportunity for hot spots (a condition where a small increase in the wall temperature causes the temperature in a certain region of the reactor to increase rapidly resulting in uncontrollable reactions) to develop as in the case of the fixed-bed reactor. However, the fluidized bed is not as flexible as the fixed bed in adding or removing heat. The loss of catalyst due to carryover with the gas stream from the reactor reduces their size to such an extent where they are no longer fluidized, but instead flow with the gas stream. For this reason, cyclone separators are placed in the effluent lines from the reactor and the regenerator to recover the fine particles. These cyclones remove the majority of the entrained equilibrium size catalyst particles and smaller fines.

The catalyst fines are attrition products caused by the collision of catalyst particles with each other and the reactor walls. These fines can escape in the cyclones because the removal efficiency of cyclones for particles of uniform density decreases with decreasing particle size. The catalyst fines captured in the reactor cyclones are transferred to the catalyst regenerator. Here, the fines are carried with the exhausted air and combustion products known as fuel gas. Most of the fine catalyst particles that are entrained in the flue gas are first captured in a two-stage cyclone within the regenerator vessel and then returned to the catalyst bed.

Reactor cyclones are employed to separate cracking catalyst from vaporized reaction products; regenerator cyclones perform the same function for flue gas. In both services, the erosive nature of the catalyst combined with rapid gas velocities may affect the steel cyclones. Typically, the reactor cyclone is exposed to 950–1,000 °F (510–538 °C) while the regenerator cyclones must handle flue gas from 1,250–1,500 °F (677–816 °C). Due to the high temperature, the

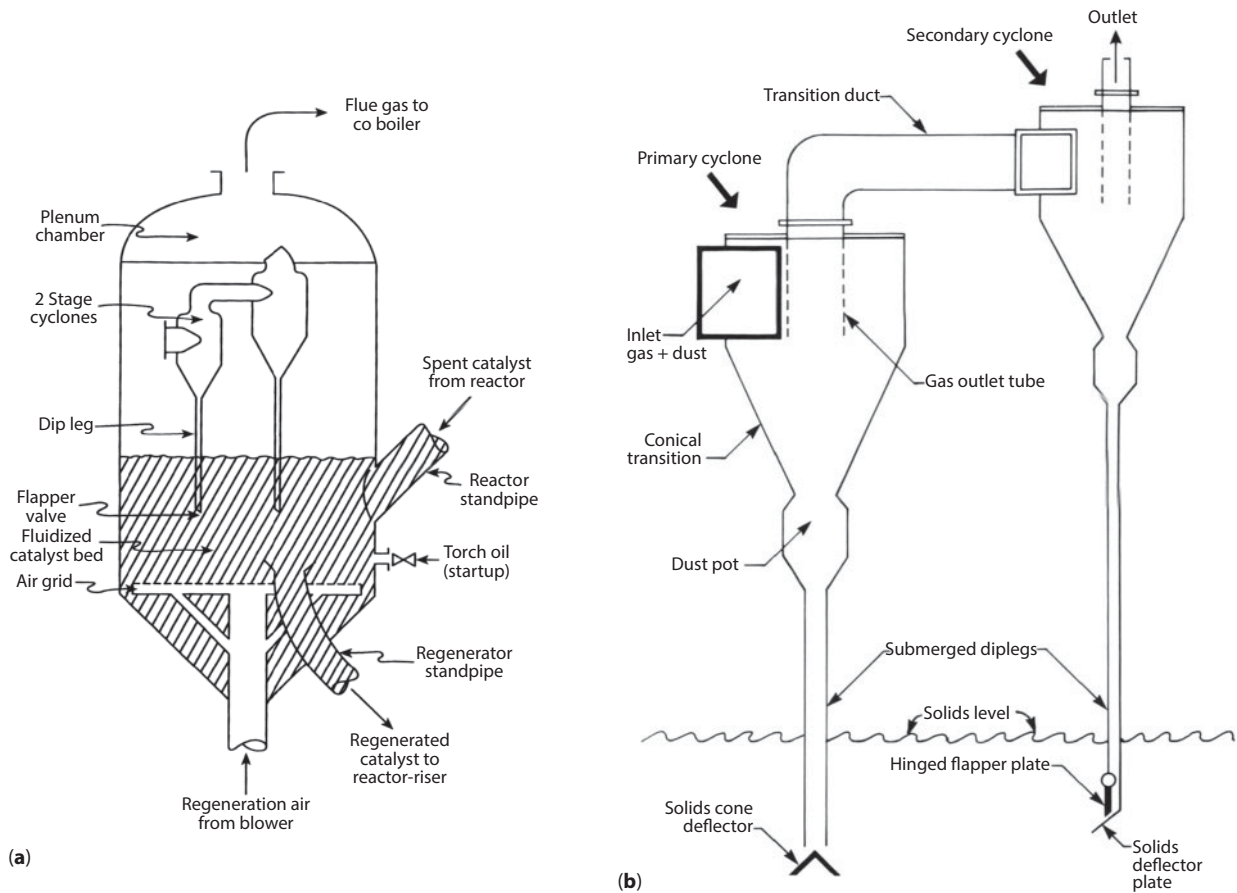


Figure 8.5 (a) FCC regenerator (Source: Gary, James, H. *et al. Petroleum Refining—Technology and Economics* 5th ed., CRC Press, Taylor & Francis Group, 2007). (b) Typical two-stage cyclone (Source: Lieberman, Norman P., *Troubleshooting Process Operations*, 2nd ed., PennWell Publishing Co., 1985).

regenerator cyclones are susceptible to failure. Some of the common causes of cyclone operational failures are:

- Dipleg unsealed
- Dipleg plugged
- Dipleg failure
- Cyclone volute plugged.
- Hole in cyclone body.

Cyclone malfunctions could result in catalyst loss; a deficient reactor cyclone may be identified by high bottom sediment and water levels in the slurry oil product. Regenerator cyclone problems are visibly identified by the increased opacity of the regenerator flue gas or by reduced rates of spent catalyst withdrawal [15]. Coker [9] illustrated the design of a cyclone separator, which is an economical device for removing particulate solids from a fluid system. Cyclone separators have been successfully employed in catalytic cracker operations. Designing cyclones often requires a balance between

the desired collection efficiency, pressure drop, space limitations and installation cost.

As the cracking proceeds, the activity of the catalyst gradually reduces due to the continuous cycling between the reactor and regenerator conditions (high temperature and the presence of ~20% steam). Therefore, to compensate for this, fresh catalyst is continuously added at about 1–2 % of the catalyst inventory per day. Some catalyst may also exit from the system through the regenerator and reactor cyclones to the stack.

The excessive temperature of 1355 °F (735 °C) or more in the regenerator can result in hydrothermal deactivation thus damaging the catalyst structure. The presence of vanadium (V) or sodium (Na) can also result in irreversible loss of catalyst activity. These metals being highly mobile in the catalyst structure act in a way to neutralize the active acid sites. Furthermore, at high concentrations, they can form low melting point eutectics thereby damaging the catalyst pore structure. Nickel

(Ni) is also an important catalyst poison, but instead of reducing its activity tends to promote undesirable dehydrogenation side reactions. This could be reduced by injecting an additive containing antimony (Sb) into the cracker feedstock. The dehydrogenation activity of nickel reduces substantially due to the passivation of nickel and the formation of an antimony nickel complex.

The catalyst that exits from the FCC reactor generally contains about 1 wt % coke with a C to H ratio of unity. In the regenerator, the coke formed during the reaction is burned off from the catalyst to restore its activity and to maintain the heat balance of the unit. The coke formed consists of a condensed, highly aromatic hydrocarbon containing traces of sulfur, and nitrogen compounds. In the regenerator, this is burnt to produce CO₂, CO, water vapor, SO₂ and oxides of nitrogen NO_x. Modern regenerators are able to burn the CO completely to CO₂. Regeneration of the catalyst is a highly important aspect in the case of zeolite catalysts because in modern FCC units, short residence time riser reactors, only 2–3 wt % carbon can be allowed on the regenerated catalyst for satisfactory performance. The amount of catalyst circulating between the regenerator and the reactor is about 5 kg per kg of feedstock [3].

The product vapors exiting from the top of the reactor at temperatures between 896–1004 °F (480–540 °C) and a pressure of 25 psig (1.72) barg are fed to the bottom of the main fractionating/distillation column. Here, the column serves the dual purpose of cooling and condensing the incoming vapors and separating the products. Gasoline and lighter products pass as overhead to the gas concentration section while cracked naphtha and the light cycle oil (LCO) exit as distillate side-draws. The fractionator bottoms product, which also contain the catalyst fines, goes to a slurry settler to concentrate the catalyst in a slurry stream, which is then recycled to the reactor feed.

About 30–50 percent of the sulfur present in the feedstock decomposes under the catalytic cracking conditions to give H₂S. This goes along with the tail gas product and sometimes is recovered for sulfur manufacture by alkanolamine extraction. The remaining sulfur compounds, which tend to be aromatic (e.g., thiophenes, benzthiophenes, etc.) are distributed in the light cycle oil and residual oil portions. Nitrogen compounds present at ppm levels partially decompose to NH₃ and HCN while the rest leaves the unit with coke and liquid products. After further processing for the removal of sulfur compounds, the cracked naphtha becomes a high-octane component of the refinery's

blended gasolines. The main fractionator off gas is sent to a recovery unit where it is separated into butanes and butylenes, propane and propylene, and lower molecular weight gases (hydrogen, methane, ethylene, and ethane).

The degree of cracking is given by the total distillate yield, which represents the volume percentage yield of products boiling in the range C₅–662 °F (350 °C). The main products separated from a catalytic cracker unit are: LPG, gasoline, light cycle oil, and residual oil. The main properties of these are as follows:

- a. **C₃–C₄ LPG product:** The C₃–C₄ LPG product obtained usually contains H₂S and mercaptans impurities. These are removed first by alkanolamine and caustic soda (NaOH) extraction before feeding to the C₃–C₄ splitter. The C₃ product exiting from the splitter contains ~ 70% propene and can be used either as a petrochemical feedstock or by alkylation or catalytic polymerization can be upgraded into motor gasoline. Similarly the C₄ product obtained from the splitter contains 50% butene and 35% isobutene, which can be either blended directly into motor gasoline or can be upgraded by alkylation or catalytic polymerization.
- b. **Gasoline:** Catalytically cracked gasoline is characterized by a rather high research octane number (RON) but a low motor octane number (MON). Octane number improvement can be obtained by operating at high reactor temperatures and by selecting a catalyst having low hydrogen transfer activity to minimize olefin saturation. The malodorous mercaptan sulfur compounds are removed generally by UOP Merox treatment.
- c. **Light Cycle Oil:** Light Cycle Oil (LCO) is characterized by a very high aromatic content (mainly two-ring naphthene derivatives) and this is the reason for its high density (940–980 kg/m³ at 15 °C). As its cetane index is very low (15–25), it becomes a poor quality diesel fuel-blending component. Thus, it is most often used as a diluent in heavy oil blends. It is also possible to upgrade LCO into gasoline by hydrocracking.
- d. **Residual Oil:** The residual oil is also characterized by its high aromatic content and density (1050–1100 kg/m³ at 15 °C). Most often this material is blended directly into fuel oil or used as feedstock for carbon black or needle coke manufacture.

Figures 8.6a–i show diagrams of FCC units from various licensors [13], and Figure 8.7 is a photograph of an FCC unit in a refinery.

FCC gas plant

Most of the refinery products from the main fractionator (Figure 8.4) cannot be sent directly into the

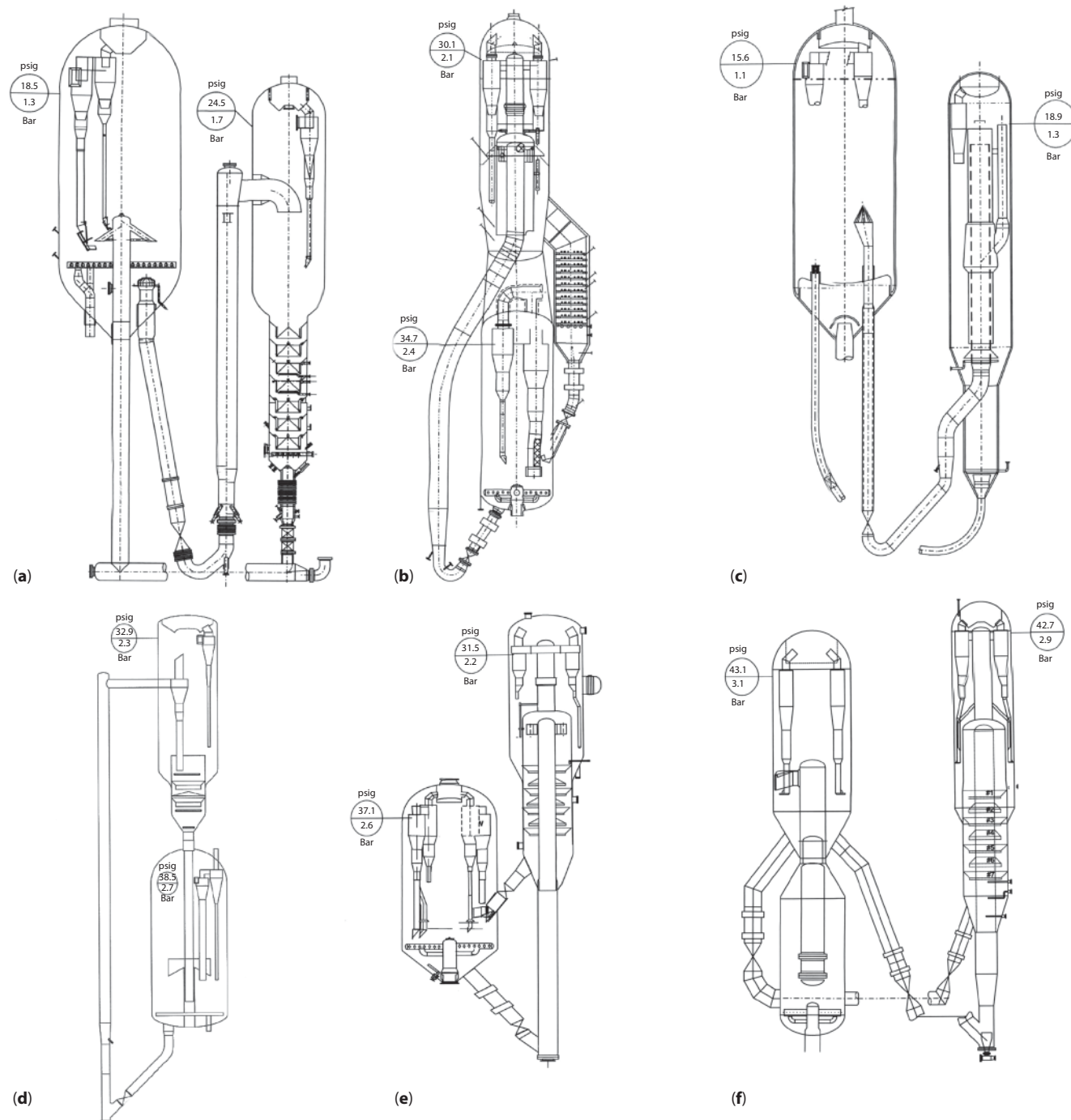


Figure 8.6 (a) Example of a Model II cat cracker with enhanced RMS design internals (Source: Sadeghbeigi, Reza, *Fluid Catalytic Cracking Handbook*, 3rd ed., Elsevier, 2012.). (b) Example of a UOP stack design FCC unit (Source: Sadeghbeigi, Reza, *Fluid Catalytic Cracking Handbook*, 3rd ed., Elsevier, 2012.). (c) Example of a Model IV design FCC unit (Source: Sadeghbeigi, Reza, *Fluid Catalytic Cracking Handbook*, 3rd ed., Elsevier, 2012.). (d) Example of KBR Orthoflow design FCC unit (Source: Sadeghbeigi, Reza, *Fluid Catalytic Cracking Handbook*, 3rd ed., Elsevier, 2012.). (e) Example of a side-by-side design FCC unit (Source: Sadeghbeigi, Reza, *Fluid Catalytic Cracking Handbook*, 3rd ed., Elsevier, 2012.). (f) Example of a UOP high-efficiency design FCC unit (Source: Sadeghbeigi, Reza, *Fluid Catalytic Cracking Handbook*, 3rd ed., Elsevier, 2012.).

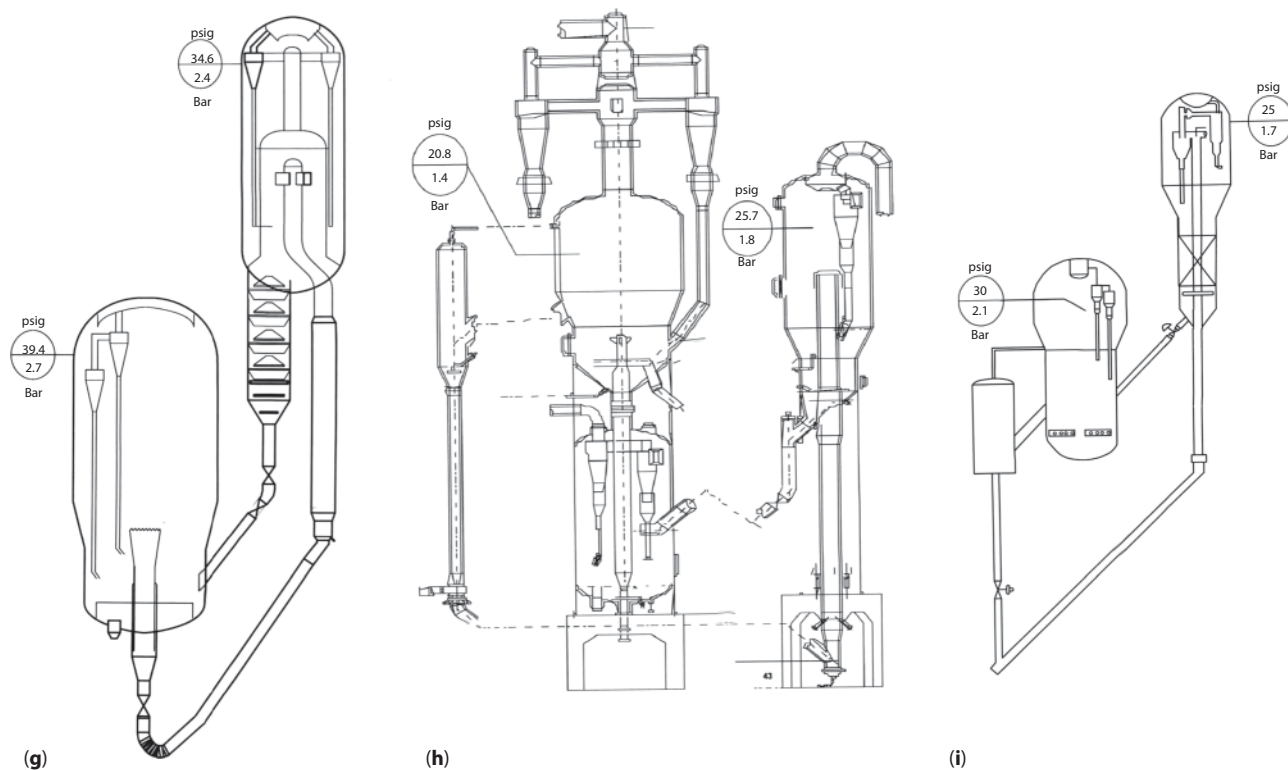


Figure 8.6 (g) Example of a flexicracker (Source: Sadeghbeigi, Reza, *Fluid Catalytic Cracking Handbook*, 3rd ed., Elsevier, 2012.). (h) Example of the Shaw Group Inc. design FCC unit (Source: Sadeghbeigi, Reza, *Fluid Catalytic Cracking Handbook*, 3rd ed., Elsevier, 2012.). (i) Example of Lummus Technology Inc. FCC unit (Source: Sadeghbeigi, Reza, *Fluid Catalytic Cracking Handbook*, 3rd ed., Elsevier, 2012.)



Figure 8.7 A photograph of an FCC. (Source: http://en.wikipedia.org/wiki/Fluid_catalytic_cracking).

refinery’s product blending pool. Additional fractionation and product isolation occur in the gas plant associated with the FCC units as shown in Figure 8.8. Here, the overhead vapor contains some C₅ components, which must be recovered into the product gasoline. A portion of the LCO product is drawn off as sponge oil to recover gasoline in a sponge oil absorber. The liquid from the overhead condenser flows to the primary absorber where C₃–C₄ components are recovered.

There is a significant value in separating and isolating the C₃–C₄ components, as these may be sold as LPG or as valuable feedstock for other petrochemical processes. The FCC gas plant is responsible for the separation of C₃–C₄ components and stabilization of gasoline. The stabilization of gasoline involves controlling the amount of C₄ components present in the product gasoline. The overhead vapor from the main fractionation column (Figure 8.8) enters the wet gas compressor train. The vapor leaving the compressor train then enters a high-pressure flash system. The vapor from the high-pressure flash enters the primary absorber. The C₅ components leave with the bottom product from

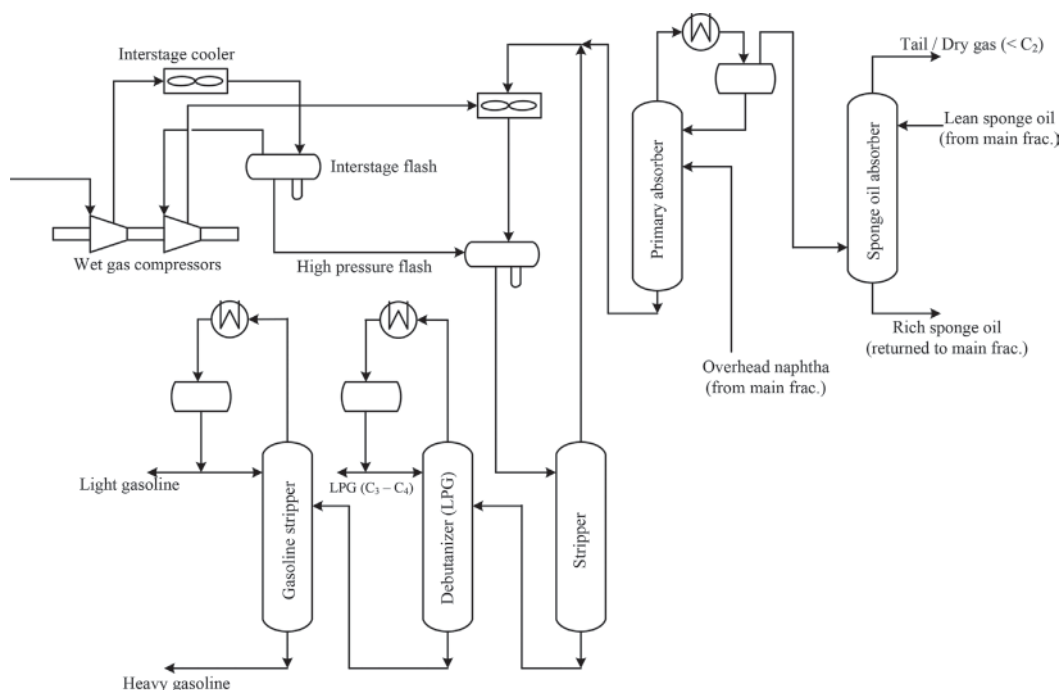


Figure 8.8 FCC gas plant unit.

the primary absorber. This bottom product reenters the high-pressure flash. The overhead vapor product enters a sponge oil absorber where it is contacted with LCO drawn off from the main fractionator. The overhead products of the sponge oil absorber are H_2 , C_1 and C_2 components that are feeds to the refinery's energy requirements. The bottoms product from the sponge oil absorber is recycled back to the main fractionator (Figure 8.8).

The liquid product from the high-pressure flash enters the primary stripping column. The overhead product from the stripping column consists mainly of C_2 components. This product is recycled back to the high-pressure flash. The bottom product from the column consists mainly of C_3 – C_4 components and gasoline. This product feeds the primary stabilizer (known as a debutanizer), which separates most of the C_3 – C_4 components into the overhead liquid. The stabilized gasoline (containing a regulated amount of C_4) leaves as the bottom product.

Some FCC gas plants further separate the gasoline product leaving the stabilizer into light and heavy gasoline. Additionally, most plants contain a water wash or injection system to control the presence of acidic compounds that result in corrosion. This water injection occurs between the stages of the overhead wet gas compressor. Most of this water leaves the process flow before entering the columns of the gas plant.

8.3 Modes of Fluidization

When fluid flows upward through a packed bed of catalyst particles at low velocity, the particles remain stationary. As the fluid velocity increases, the pressure drop (ΔP) increases. Further increase in velocity creates a balance of ΔP multiplied by the cross-sectional area equals the gravitational force on the particle mass. The particle begins to move. This is the minimum fluidizing velocity as illustrated in Figure 8.9. The stable fluidization starts at a certain ΔP . As the velocity increases, the bed expands and bed porosity increases while the ΔP remains constant. This is the practical region that includes all modes of fluidization such as bubbling, slugging and pneumatic transport.

Modes of Fluidization in FCC unit

The principle in the mode of fluidization is employed to operate the different parts of the FCC unit. The regenerator is operated at the higher velocity of the stable turbulent fluidization. The line connecting the regenerator to the riser is carried out at the “bubbling fluidization” zone. The riser is operated at the “pneumatic transport” zone, where the catalyst and products are carried out from the riser. In the stripper section

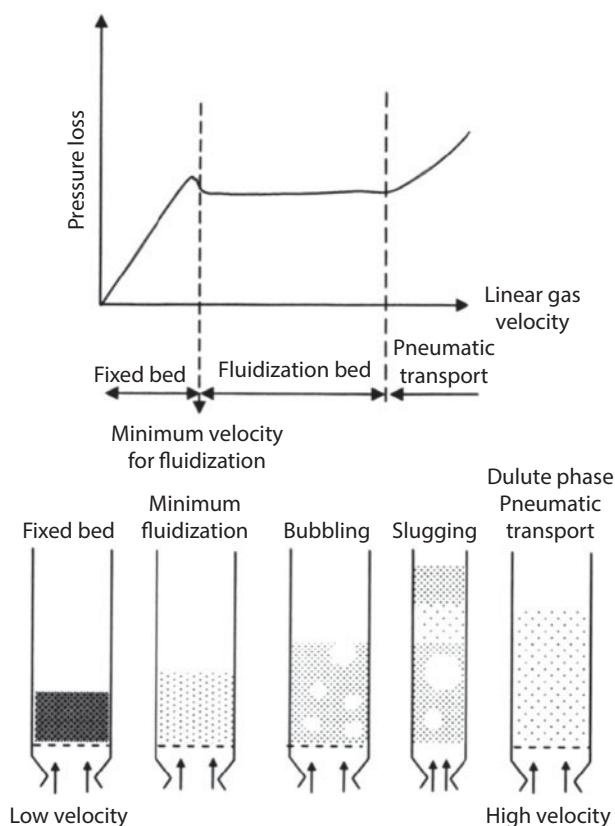


Figure 8.9 Modes of fluidization.

Table 8.4 Modes of fluidization in FCC.

Location in FCC	Modes of fluidization
Regenerator	Turbulent fluidization: to attain uniform burning temperature in the bed.
Line for catalyst transport from regenerator to the riser	Bubbling fluidization
Riser	Pneumatic transport: Catalyst and products are carried out from the riser. Plug flow has a few seconds of residence time.
Stripper	Bubbling fluidization: Steam is injected in the stripper to vaporize and recover heavy oil and reduce coke formation
Lift line from regenerator to the reactor	Pneumatic transport.

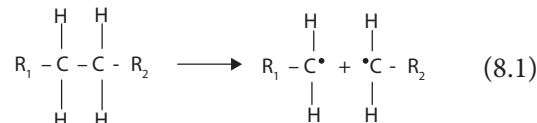
where steam is injected, the mode is “bubbling fluidization”. The regenerated catalyst is transported back in the left line in a “pneumatic transport” mode. These modes are summarized in Table 8.4.

8.4 Cracking Reactions

Thermal Cracking

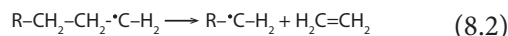
This is the primary process of converting low-value feedstocks into lighter products. Thermal cracking processes are employed in vacuum distillation unit (VDU), visbreaker unit (VBU) and delayed coking unit (DCU) for cracking or residual hydrocarbons as illustrated in earlier chapters.

Thermal cracking is a function of temperature and time. The reaction occurs when hydrocarbons in the absence of a catalyst are exposed at high temperature in the range of 800–1,200 °F (425–650 °C). The initial step in the chemistry of thermal cracking is the formation of free radicals by splitting the C–C bond. A free radical is an uncharged molecule with an unpaired electron. The rupturing gives two uncharged species that share a pair of electrons. Eq. 8.1 illustrates the formation of a free radical when a paraffin molecule is thermally cracked.



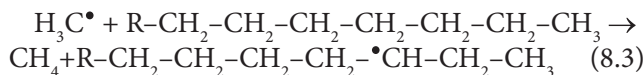
Free radicals are extremely reactive and short-lived. They can undergo alpha (α)-scission, beta (β) scission and polymerization. α -scission is a break of one carbon away from the free radical, β -scission, and two carbons away.

β -scission produces an olefin (ethylene) and a primary free radical that has two fewer carbon atoms as in Eq. 8.2.

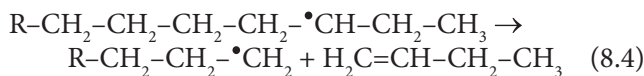


The newly formed primary free radical can undergo further β -scission to produce more ethylene.

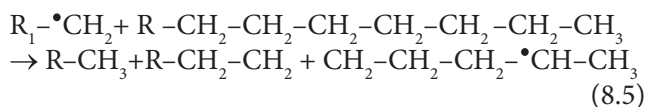
α -scission produces a methyl radical that can extract a hydrogen atom from a neutral hydrocarbon molecule. The hydrogen extraction produces methane and a secondary or tertiary free radical as in Eq. 8.3.



This radical can undergo β -scission. The products will be an α -olefin and a primary free radical as in Eq. 8.4



Similar to the methyl radical, the $R-\bullet\text{CH}_2$ radical can also extract a hydrogen atom from another paraffin to form a secondary free radical and smaller paraffin as in Eq. 8.5.



$R-\bullet\text{CH}_2$ radical is more stable than $\text{H}_3\bullet\text{C}$; consequently the hydrogen extraction rate of $R-\bullet\text{CH}_2$ is lower than that of the methyl radical. This sequence of reactions forms a product rich in C_1 and C_2 and small amount of α -olefin. Free radicals undergo little branching (isomerization).

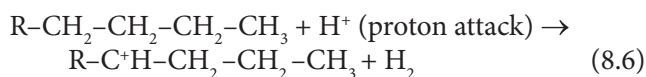
A drawback of thermal cracking in FCC is that a high percentage of the olefins formed during intermediate reactions polymerizes and condenses directly to coke.

Catalytic Cracking

Mechanism of Catalytic Cracking Reactions

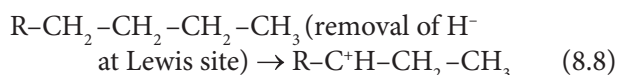
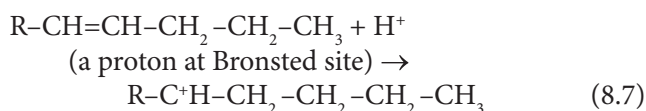
When feed contacts the regenerated catalyst, it vaporizes, and the positive-charged atoms referred to as carbocations are formed. Carbocation is a term used for a positively charged carbon ion. This can either be carbonium or carbenium ions.

A carbonium ion, CH_5^+ , is formed by adding a hydrogen ion (H^+) to a paraffin molecule (Eq. 8.6). This is accomplished via direct attachment of a proton from the catalyst Bronsted site. The resulting molecule will have a positive charge with five bonds to it.



The carbonium ion's charge is not stable, and the acid sites on the catalyst are not strong enough to form many carbonium ions. Nearly all the catalytic cracking chemistry is carbenium ion chemistry.

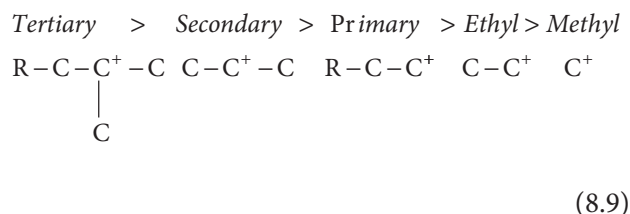
A carbenium ion, $R-\text{CH}_2^+$, comes either from adding a positive charge to an olefin or from removing a hydrogen and two electrons from a paraffin (Eqs. 8.7 and 8.8)



Both the Bronsted and Lewis acid sites on the catalyst generate carbenium ions. The Bronsted site donates

a proton to an olefin and the Lewis site removes electrons from a paraffin molecule. In commercial units, olefins come in with the feed or are produced through thermal cracking reactions.

The stability of carbocations depends upon the nature of alkyl groups attached to the positive charge. The relative stability of carbenium ions is as follows with tertiary ions being the most stable.

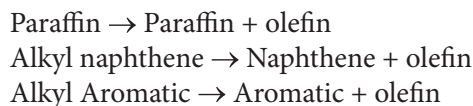


A benefit of catalytic cracking is that the primary and secondary ions tend to rearrange to form a tertiary ion (a carbon with three other carbon bonds attached), and the increased stability of tertiary ions accounts for the high degree of branching associated with catalytic cracking operation.

Catalytic cracking reactions can be classified into two broad categories:

1. Primary cracking of the gas oil molecules
2. Secondary rearrangement and re cracking of cracked products.

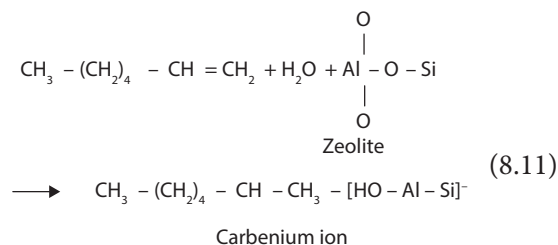
The primary reactions are those involving the initial carbon-carbon bond scission and the intermediate neutralization of the carbonium ion involving the following steps:



Step. 1: Olefin is formed by mild thermal cracking of paraffin.

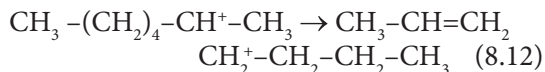


Step. 2 Proton shift



Step. 3 Beta scission:

Carbon-carbon scission takes place at the carbon in the position beta to the carbenium ions and olefins.

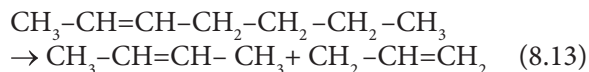


The newly formed carbonium ion reacts with another paraffin molecule and further propagates the reaction.

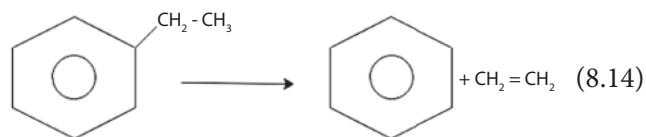
The chain reaction is terminated when (a) the carbenium ion loses a proton to the catalyst and is converted to an olefin or (b) the carbenium ion picks up a hydride ion from a donor (e.g., coke) and converts to paraffin.

Other hydrocarbons that are formed by primary cracking are:

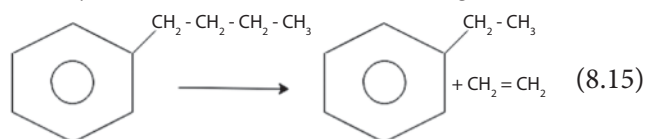
1. Olefins – smaller olefins



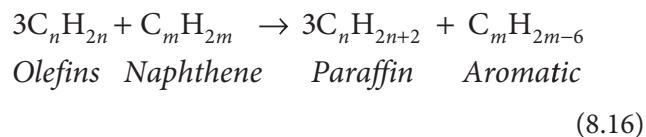
2. Alkylaromatics – Dealkylation



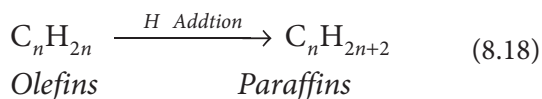
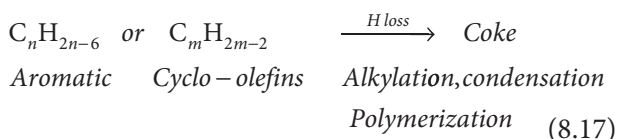
3. Alkylaromatics – Side chain cracking



Hydrogen transfer plays a principal role in the gas oil cracking process as it reduces the amount of olefins in the product and contributes to coke formation. This influences the molecular weight distribution of the product. Through this process, highly reactive olefins are converted to more stable paraffins and aromatics as follows:



Further loss of hydrogen to olefins by aromatics or other hydrogen-deficient products results in more paraffins and coke.

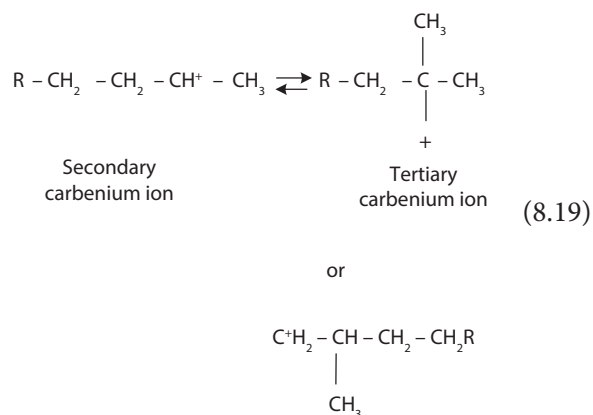


8.4.1 Secondary Reactions

Gasoline formed from primary cracking can further undergo secondary cracking, which is generally caused by hydrogen transfer mechanisms such as isomerization, cyclization and coke formation.

Isomerization

Isomerization reactions occur frequently in catalytic cracking and infrequently in thermal cracking. In both reactions, breaking of a bond is via β-scission. However, in catalytic cracking, carbocations tend to rearrange to form tertiary ions. Tertiary ions are more stable than secondary and primary ions; they shift around and crack to produce branched molecules (Eq. 8.19). In thermal cracking, free radicals give normal or straight-chain compounds.

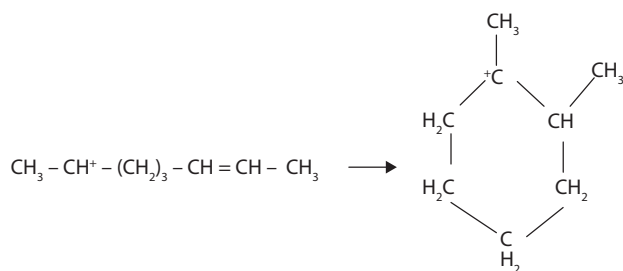


The final product is the termination of paraffins and olefins to iso-paraffins.

Some of the advantages of isomerization are as follows:

- Higher octane in gasoline fraction. Isoparaffins in the gasoline boiling range have higher octane than normal paraffins.
- High-value chemical and oxygenate feedstocks in the C₃/C₄ fraction. Isobutylene and isoamylene are used for the production of methyl tertiary butyl ether (MTBE) and tertiary amyl methyl ether (TAME). MTBE and TAME can be blended into the gasoline to reduce auto emissions.
- Lower cloud point in the diesel fuel. Isoparaffins in the LCO boiling range improve the cloud point.

Cyclization



The final result is the cyclization of olefins to naphthenes and possibly further cyclization to coke.

The main reactions in the FCC reactor are summarized as follows [19]:

Paraffins

Thermal catalytic cracking

Paraffin cracking \rightarrow Paraffins + Olefins

Olefins

The following reactions can occur with olefins:

Olefin cracking \rightarrow LPG olefins

Olefin cyclization \rightarrow Naphthenes

Olefin isomerization \rightarrow Branched olefins + Branched paraffins

Olefin H-transfer \rightarrow Paraffins

Olefin cyclization \rightarrow Coke

Naphthenes

Naphthene cracking \rightarrow Olefins

Naphthene dehydrogenation \rightarrow Aromatics

Naphthene isomerization \rightarrow Restructured naphthenes

Aromatics

Aromatics (side chain) \rightarrow Aromatics + Olefins

Aromatic transalkylation \rightarrow Alkylaromatics

Aromatic dehydrogenation \rightarrow Polyaromatics \rightarrow Coke

Other Reactions

Cracking, isomerization and hydrogen transfer reactions account for the majority of catalytic cracking reactions. Other reactions play an essential role in unit operations. Two principal reactions are dehydrogenation and coking.

Dehydrogenation: Under ideal conditions, i.e., a “clean” feedstock and a catalyst with no metals, cat cracking does not yield any appreciable amount of molecular hydrogen. Therefore, dehydrogenation reactions will proceed only if the catalyst is contaminated with metals such as nickel (Ni) and vanadium (V).

Coking: Cat cracking yields a residue called coke. The chemistry of coke formation is complex; similar to hydrogen transfer reactions; catalytic coke is a “bimolecular” reaction. It proceeds via carbenium ions or free radicals. Generally, coke yield should increase as the hydrogen transfer rate increases. However, it is postulated that reactions producing unsaturates and multi-ring aromatics are the principal coke-forming compounds. Unsaturates such as olefins, diolefins and multi-ring polycyclic olefins are very reactive and can polymerize to form coke [14]. Table 8.5 shows the important reactions that take place in the FCC unit.

8.5 Thermodynamics of FCC

The principal reaction taking place during cracking in FCC unit is β -scission that is not equilibrium limited. Thus, the thermodynamics are limited in either estimating the extent of a reaction or adjusting the operating variables. Cracking of long-chain paraffins and olefins can rise up to 95% completion at cracking conditions.

In some cases, hydrogen transfer reactions occur in the same way. However, isomerization, transalkylation, dealkylation and dehydrogenation reactions are intermediate in reaching equilibrium. Condensation reactions, such as olefin polymerization and paraffin alkylation, are often less favorable to higher temperatures. Table 8.6 shows the equilibrium constants and the heat of reaction of these reactions, where the type and magnitude have an impact upon the heat balance of the unit. A catalyst with fewer hydrogen transfer characteristics will cause the net heat of reaction to be more endothermic, and this will require a higher catalyst circulation and possibly a higher coke yield to maintain the heat balance.

8.5.1 Transport Phenomena, Reaction Patterns and Kinetic models

The riser (the transported solid-bed reactor) is the main reactor of the FCC unit. Inside the riser, catalytic cracking of the paraffins, naphthenes and aromatics takes place. Before the chemical reactions, there are several physical phenomena that occur on a molecular scale. Figure 8.10 shows the sequence of steps that takes place.

1. Transport of reactants (A, B, ...) from the fluid bulk to the catalyst surface.

Table 8.5 Important reactions occurring in the FCC unit [13].

1.	Cracking	
	Paraffins cracked to olefins and smaller paraffins	$C_{10}H_{22} \rightarrow C_4H_{10} + C_6H_{12}$
	Olefins cracked to smaller olefins	$C_9H_{18} \rightarrow C_4H_8 + C_5H_{10}$
	Aromatic side-chain scission	$ArC_{10}H_{21} \rightarrow ArC_5H_9 + C_5H_{12}$
	Naphthenes (cycloparaffins) cracked to olefins and smaller ring compounds	$Cyclo - C_{10}H_{20} \rightarrow C_6H_{12} + C_4H_8$
2.	Isomerization	
	Olefin bond shift	$1 - C_4H_8 \rightarrow trans - 2 C_4H_8$
	Normal olefin to iso-olefin	$n - C_5H_{10} \rightarrow iso - C_5H_{10}$
	Normal paraffin to iso-paraffin	$n - C_4H_{10} \rightarrow iso - C_4H_{10}$
	Cyclohexane to cyclopentane	$C_6H_{12} \rightarrow C_5H_9CH_3$
3.	Hydrogen transfer	$Naphthene + olefin \rightarrow aromatic + paraffin$
	Cycloaromatization	$C_6H_{12} + 3C_5H_{10} \rightarrow C_6H_6 + 3C_5H_{12}$
4.	Transalkylation/alkyl-group transfer	$C_6H_4(CH_3)_2 + C_6H_6 \rightarrow 2C_6H_5CH_3$
5.	Cyclization of olefins to naphthenes	$C_7H_{14} \rightarrow CH_3cyclo - C_6H_{11}$
6.	Dehydrogenation	$n - C_8H_{18} \rightarrow C_8H_{16} + H_2$
7.	Dealkylation	$Iso - C_3H_7C_6H_5 \rightarrow C_6H_6 + C_3H_6$
8.	Condensation	$Ar - CH=CH_2 + R_1CH=CHR_2 \rightarrow Ar - Ar + 2H$

2. Transport of reactants inside the catalyst pores.
3. Adsorption of reactants to the catalytic site.
4. Surface reaction among molecules or atoms adsorbed.
5. Desorption of products (R, S, ...)
6. Transport of products from pores to the catalyst surface.
7. Transport of products from the catalyst surface to the fluid bulk.

There are a great number of compounds that are present in a feedstock of the FCC unit; it is almost impossible to model each step in the catalytic reaction taking place inside the riser. Thus global average approaches are considered. During catalytic cracking reactions, another family of hydrocarbons that is absent in the original feedstock is produced: olefins (i.e., alkenes), unsaturated compounds. These are

compounds that are characterized by the presence of double bonds between adjacent carbons and thus show the formation of energies different from those of their analogous paraffins (i.e., alkanes), saturated compounds. Among the cracking reactions that break C-C bonds, there are simpler ones:

Cracking of long paraffins in order to form lighter ones:



Cracking of naphthenes to yield olefins:

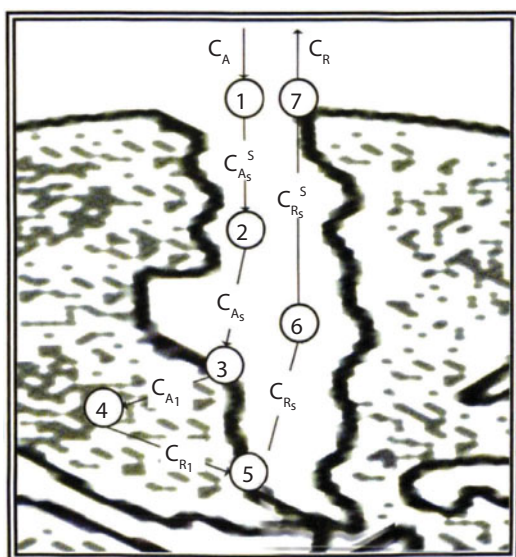


Cracking of olefins:

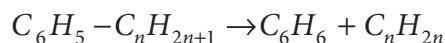


Table 8.6 Typical thermodynamic data for idealized reactions of importance in catalytic cracking [13].

Reaction class	Specific reaction	Log K_E Equilibrium constant			Heat of reaction
		850 °F	950 °F	980 °F	950 °F
Cracking	$n - C_{10}H_{22} \rightarrow n - C_7H_{16} + C_3H_6$	2.04	2.46	-	32,050
	$1 - C_8H_{16} \rightarrow 2C_4H_8$	1.68	2.1	2.23	33,663
Hydrogen transfer	$4C_6H_{12} \rightarrow 3C_6H_{14} + C_6H_6$	12.44	11.09	-	109,681
	$cyclo - C_6H_{12} + 3 1 - C_5H_{10} \rightarrow 3n - C_5H_{12} + C_6H_6$	11.22	10.35	-	73,249
Isomerization	$1 - C_4H_8 \rightarrow trans - 2 - C_4H_8$	0.32	0.25	0.09	-4,874
	$n - C_6H_{10} \rightarrow iso - C_6H_{10}$	-0.2	-0.23	-0.36	-3,420
	$o - C_6H_4(CH_3)_2 \rightarrow m - C_6H_4(CH_3)_2$	0.33	0.30	-	-1,310
	$cyclo - C_6H_{12} \rightarrow CH_3 - cyclo - C_5H_9$	1.00	1.09	1.10	6,264
Transalkylation	$C_6H_6 + m - C_6H_4(CH_3)_2 \rightarrow 2C_6H_5CH_3$	0.65	0.65	0.65	-221
Cyclization	$1 - C_7H_{14} \rightarrow CH_3 - cyclo - C_6H_{11}$	2.11	1.54	-	-37,980
Dealkylation	$iso - C_3H_7 - C_6H_5 \rightarrow C_6H_6 + C_3H_6$	0.41	0.88	1.05	40,602
Dehydrogenation	$n - C_6H_{14} \rightarrow 1 - C_6H_{12} + H_2$	-2.21	-1.52	-	56,008
Polymerization	$3C_2H_4 \rightarrow 1 - C_6H_{12}$	-	-	-1.2	-
Paraffin alkylation	$1 - C_4H_8 + iso - C_4H_{10} \rightarrow iso - C_8H_{18}$	-	-	3.3	-


Figure 8.10 Typical steps of a catalytic reaction process (Source: Froment and Bischoff [17]).

Dealkylation of alkali aromatics:



Breaking of alkali side chains of aromatics



Also, there are several second-step reactions as hydride transfer (e.g., naphthene + olefin \rightarrow aromatic + paraffin), isomerization, transfer of alkali groups, condensation reactions, and low olefin disproportionation, which are all important in the final product distribution. Some reactions such as paraffin and olefin alkylation, aromatic hydrogenation and olefin polymerization (except ethylene polymerization) are not as significant; however, there are three main reaction groups [23]:

1. **Primary reaction:** mainly the formation of compounds in gasoline (C_5 to C_{12}), n-butane, butenes, and propylenes. It is important to note that gasoline compounds can follow secondary (or overcracking) reactions due to their reactivity.
2. **Hydride transfer:** reactions that reduce the amount of olefin, influence the molecular weight distribution of products, and increase the selectivity to gasoline; moreover they increase the antiknock index (AKI). However, they also favor coke formation and consequently catalyst deactivation.
3. **Coke formation:** reactions currently under study that provide coke deposition on the catalyst surface. Coke is an entity that forms under almost any operating conditions and from many precursors. Also, coke is formed by the polymerization of ethylene, the condensation of aromatics, etc. Coke is considered to be a carbon formation similar to graphite, whose molecular weight is in the range of 940–1010Da [24].

The FCC process involves a network of reactions as described and producing a large number of components. Therefore, some simplifying approaches have been developed; one is lumping the agglomeration of several chemical compounds into a single compound (i.e., a lump), which exhibits some or several common properties (e.g., boiling point, molecular weight, reactivity).

The FCC modeling is classified into two categories: kinetic and unit-level models. Kinetic models focus on chemical reactions taking place within the riser or reactor sections of the FCC unit, and quantify the feed as a mixture of chemical entities to describe the rate of reaction from one chemical entity to another. However, the unit-level models contain several sub-models that account for the integrated nature of the modern FCC units. For example, a basic unit-level model contains sub-models for the riser/reactor, regenerator and catalyst transfer sections. The riser requires a kinetic model that describes the conversion of chemical entities. The regenerator contains another kinetic model that describes the process of coke removal from the catalyst, while the unit-level model solves the heat balance between the riser and the regenerator.

Weekman and Nace [18] proposed the first lumped kinetic scheme for FCC, which consists of three observable lumps, called feedstock (VGO), gasoline,

and coke + gases (Figure 8.11a). These were chosen because it was possible to measure the first two and the coke produced drives the energy dynamics of the entire unit. Furthermore, the kinetics depend on only three rate constants (k_1 , k_2 and k_3), which are a function of feedstock composition, operating conditions, etc. However, it was noted that there are more observable products that were not included in the scheme, and further studies have improved on this model to four-, five- and seven-lump models [19, 20 and 21] as illustrated in Figures 8.11b, 8.11c and 8.11d, respectively. Chang *et al.* [21] have reviewed various kinetic models and their limitations in FCC units.

8.5.2 Three- and Four-Lump kinetic models

Assuming that vacuum gas oil (VGO) produces two products: gasoline and a combined product of gas and coke, where y refers to the mass fraction of each lump and k is the reaction rate constant. Assuming that the VGO cracking rate is second order and gasoline rate is first order. The catalyst deactivation rate ϕ is considered equal for all reactions.

Three-lump kinetic model (Figure 8.11a)

For VGO

$$r_1 = \frac{dy_1}{dt} = -k_1 y_1^2 \phi - k_3 y_1^2 \phi = -(k_1 + k_3) y_1^2 \phi \quad (8.20)$$

For gasoline:

$$r_2 = \frac{dy_2}{dt} = k_1 y_1^2 \phi - k_2 y_2 \phi = (k_1 y_1^2 - k_2 y_2) \phi \quad (8.21)$$

For gas + coke:

$$r_3 = \frac{dy_3}{dt} = (k_3 y_1^2 + k_2 y_2) \phi \quad (8.22)$$

Four-lump kinetic model (Figure 8.11b):

For VGO:

$$r_1 = \frac{dy_1}{dt} = -(k_{12} + k_{13} + k_{14}) y_1^2 \phi \quad (8.23)$$

For gasoline:

$$\begin{aligned} r_2 = \frac{dy_2}{dt} &= k_{12} y_1^2 \phi - k_{23} y_2 \phi - k_{24} y_2 \phi \\ &= (k_{12} y_1^2 - k_{23} y_2 - k_{24} y_2) \phi \end{aligned} \quad (8.24)$$

For gas:

$$r_3 = \frac{dy_3}{dt} = (k_{23} y_2 + k_{13} y_1^2) \phi \quad (8.25)$$

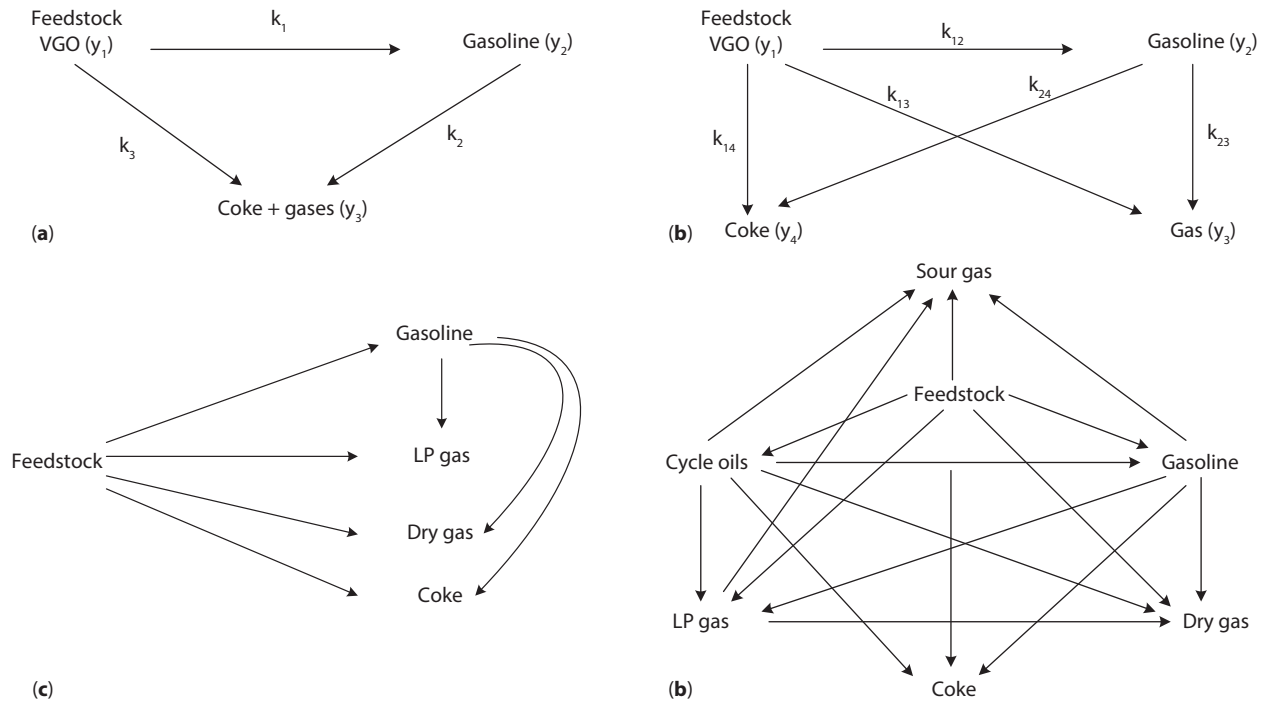


Figure 8.11 (a) Three-lump kinetic model (Source: Weekman and Nace [18]). (b) Four-lump kinetic model (Source: Fahim, M. A., *et al.* [10]). (c). Five-lump model (Source: Ancheytta-Juarez, *et al.* [19]). (d) Seven-lump model (e.g. Maya-Yescas, *et al.* [20]).

Table 8.7 Experimental data at 548.9 °C and catalyst to oil ratio (C/O = 4) (Ancheytta-Juarez and Murillo-Hernandez [19]).

Space velocity (h ⁻¹)	Conversion (wt %)	VGO (wt %)	Gasoline (wt %)	Gas (wt %)	Coke (wt %)
10	82.38	17.62	54.16	21.08	7.14
20	71.18	28.82	48.65	16.81	5.72
30	62.04	37.96	43.85	13.6	4.59
60	49.26	50.74	37.67	8.85	2.74

For coke:

$$r_4 = \frac{dy_4}{dt} = (k_{14} y_1^2 + k_{24} y_2) \phi \quad (8.26)$$

Table 8.7 shows experimental data used to determine the reaction rate constants.

Example 8-1

Determine the concentration profiles of VGO, gasoline and gas+ coke with time for the rate constant values of $k_1 = 23\text{h}^{-1}$, $k_2 = 3.1\text{h}^{-1}$ and $k_3 = 7.5\text{h}^{-1}$ using the three-lump kinetic model with $\phi = 1.0$.

Solution

For the three-lump kinetic model and $\phi = 1.0$. The rate equations are:

$$\frac{dy_1}{dt} = -(k_1 + k_3) y_1^2 \quad (S8.1.1)$$

$$\frac{dy_2}{dt} = (k_1 y_1^2 - k_2 y_2) \quad (S8.1.2)$$

$$\frac{dy_3}{dt} = (k_3 y_1^2 + k_2 y_2) \quad (S8.1.3)$$

Initial conditions at $t_o = 0$ are $y_1 = 1$, $y_2 = 0$, and $y_3 = 0$. The final $t_f = 0.5$ and the differential equations S8.1.1, S8.1.2 and S8.1.3 are solved numerically using the POLYMATH software. Figure 8.12a shows the profiles vs. time of VGO, gasoline and gas + coke. The results from the POLYMATH software were imported into Excel spreadsheet (Example 8.1.xlsx) to determine

the conversion and yields. Figure 8.12b shows plots of VGO, gasoline, gas and coke yields vs. conversion.

POLYMATH report	No Title
Ordinary Differential Equations	10-Feb-2017

Calculated values of DEQ variables

	Variable	Initial value	Minimal value	Maximal value	Final value
1	K1	23.	23.	23.	23.
2	K2	3.1	3.1	3.1	3.1
3	K3	7.5	7.5	7.5	7.5
4	t	0	0	0.5	0.5
5	Y1	1.	0.0615385	1.	0.0615385
6	Y2	0	0	0.4558894	0.1925894
7	Y3	0	0	0.7458722	0.7458722

Differential equations

1	$d(Y3)/d(t) = (K3*Y1^2+K2*Y2)$
2	$d(Y2)/d(t) = (K1*Y1^2-K2*Y2)$
3	$d(Y1)/d(t) = -(K1+K3)*Y1^2$

Explicit equations

1	$K3 = 7.5$
2	$K2 = 3.1$
3	$K1 = 23$

General

Total number of equations	6
Number of differential equations	3
Number of explicit equations	3
Elapsed time	0.000 sec
Solution method	RKF_45
Step size guess. h	0.000001
Truncation error tolerance. eps	0.000001

Data file: c:\users\hp\desktop\polymath files\example 8.1.pol

8.6 Process Design Variables

Many FCC design variables are used to tailor the unit design to the requirements of a specific application. These variables are:

- Feed temperature.
- Feed dispersion steam rate.
- Regenerator combustion mode

- Regenerator heat removal
- Disengager and regenerator pressures

These are briefly discussed as follows [4]:

Feed temperature: The design feed temperature affects the feed preheat exchanger train configuration and the possible requirement of a fired feed heater. In general, modern FCC designs do not include fired feed heaters, except for those units designed for the production of middle distillates.

Feed Dispersion Steam Rate: The selection of a design feed dispersion steam rate influences the sizing of the feed injection nozzles, so that dispersion steam rate is both a design and an operating variable. Design dispersion steam rates are commonly in the range between 2 and 5 wt % of feed, depending on the feed quality. The lower values are most appropriate for vacuum gas oil feedstocks, while dispersion steam rates near the upper end of the range are most appropriate for higher-boiling, more difficult to vaporize residual feedstocks. Once the feed nozzle design has been specified, a dispersion steam operating range is chosen for optimizing the unit.

Regenerator Combustion Mode: Oxygen-lean regeneration (partial CO combustion) is most suitable for use with heavy residuals, where regenerator heat release and air consumption are high due to high coke yield. Additionally, oxygen-lean regeneration offers improved catalyst activity maintenance at high catalyst vanadium levels, due to reduced vanadium mobility at lower oxygen levels. Factors that impact the selection of regeneration mode are:

- A unit designed to operate in oxygen-lean mode of regeneration must include a CO boiler to reduce CO emissions to environmentally safe levels. If a CO boiler is included, the FCC may also be operated in a full CO combustion mode, with the CO boiler serving to recover sensible heat from the flue gas.
- Unit investment cost is lower for oxygen-lean regeneration due to reduced regenerator, air blower, and flue gas system size.
- Steam production can be maximized by operating in oxygen-lean mode of regeneration due to combustion in the CO boiler.
- Regenerator heat removal system (such as catalyst coolers) may be avoided in some cases if the unit is operated in oxygen-lean mode regeneration.
- In some cases, complete CO combustion will allow the unit to operate with a lower coke yield, thereby increasing the yield of liquid products.

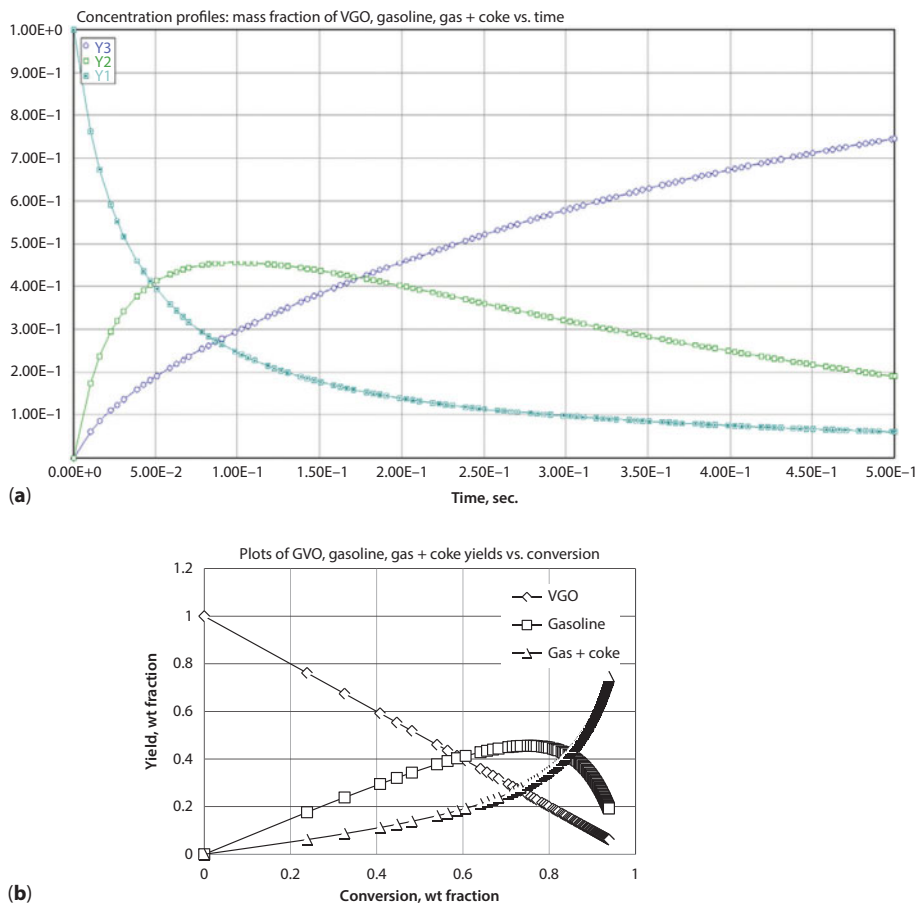


Figure 8.12 (a) Profiles of VGO, gasoline, gas + coke vs. time. (b) Plots of VGO, gasoline, gas + coke vs. conversion.

- SO_x emissions can be controlled to lower levels with complete CO combustion, due to a lower coke-burning rate and because SO_x-reducing catalyst additives are more effective at the higher regenerator oxygen content.

8.6.1 Process Variables

The major operating variables that affect the conversion and product distribution are the cracking temperature, catalyst-to-oil ratio, space velocity, catalyst type and activity, and recycle ratio. These terms are defined:

Activity:	Ability to crack a gas oil to lower boiling fractions.
Catalyst-to-oil ratio (Cat/Oil)	lb catalyst/lb feed.
Conversion	100 (volume of feed-volume of cycle stock)/volume of feed.
Cycle stock	Portion of catalytic cracker effluent not converted to naphtha and lighter products [generally the material boiling above 430°F (220°C)].

Efficiency	(% gasoline) x Conversion
Selectivity	The ratio of the yield of desirable products to the yield of undesirable products (coke and gas).
Space velocity	Space velocity may be defined on either a volume (LHSV) or a weight (WHSV) basis. In a fluidized bed reactor, the LHSV has little meaning because it is difficult to establish the volume of the bed. The weight of the catalyst in the reactor can be easily determined or calculated from the residence time and catalyst-to-oil ratio (Cat/Oil).
LHSV	(Liquid hourly space velocity in volume feed)/(volume catalyst) (hr).
WHSV	(Weight hourly space velocity in lb feed)/(lb catalyst) (hr). If t is the catalyst residence time in hours, then WHSV = 1/(t) (Cat/Oil)

Within the limits of normal operation, increasing reaction temperature, catalyst-to-oil ratio, catalyst activity and contact time result in an increase in

conversion. Conversely, a decrease in space velocity increases conversion. However, an increase in conversion does not necessarily mean an increase in gasoline yield, as an increase in temperature above a certain level can increase conversion, coke and gas yields and octane number of the gasoline but decrease gasoline yield [5, 6]. In many FCC units, conversion and capacity are limited by the regenerator coke-burning ability. This limitation can be due to either air compression limitation or the after burning temperatures in the last stage regenerator cyclones. Generally, FCC units are operated at the maximum practical regenerator temperature with the reactor temperature and throughput ratio selected to minimize the secondary cracking of gasoline to gas and coke. As heavier feedstocks are being processed, the carbon-forming potential of catalytic cracker feeds is increasing, and some units limited in carbon-burning ability because of limited blower capacity and adding oxygen contents of the gases to the regenerator temperature capacity and heat removal capacity [1].

The reactor pressure is generally limited to 15–20 psig (1.03–1.38 barg) by the design for the units, and

therefore, is not widely used as an operating variable. An increase in pressure increases coke yield and the degree of saturation of the gasoline but decreases the gasoline octane. Furthermore, it has little effect on the conversion. The initial charge to FCC using riser cracking is ~3 to 5 tons of catalyst per 1000 BPSD charge rate. Catalyst circulation rate is approximately 1 ton/min per MBPD charge rate. Figure 8.13 shows a process and instrumentation diagram of a typical FCC unit, and Table 8.8 gives a typical operation of these units.

8.6.2 Process Operational Variables

FCC operating variables can be classified as dependent and independent variables. The dependent ones are regenerator temperature, catalyst circulation rate because operators do not have direct control of these variables; correspondingly the independent ones that operators have direct control are the recycle rate or the riser outlet temperature; feed preheated temperature, fresh feed rate; catalyst makeup rate and gasoline end point.

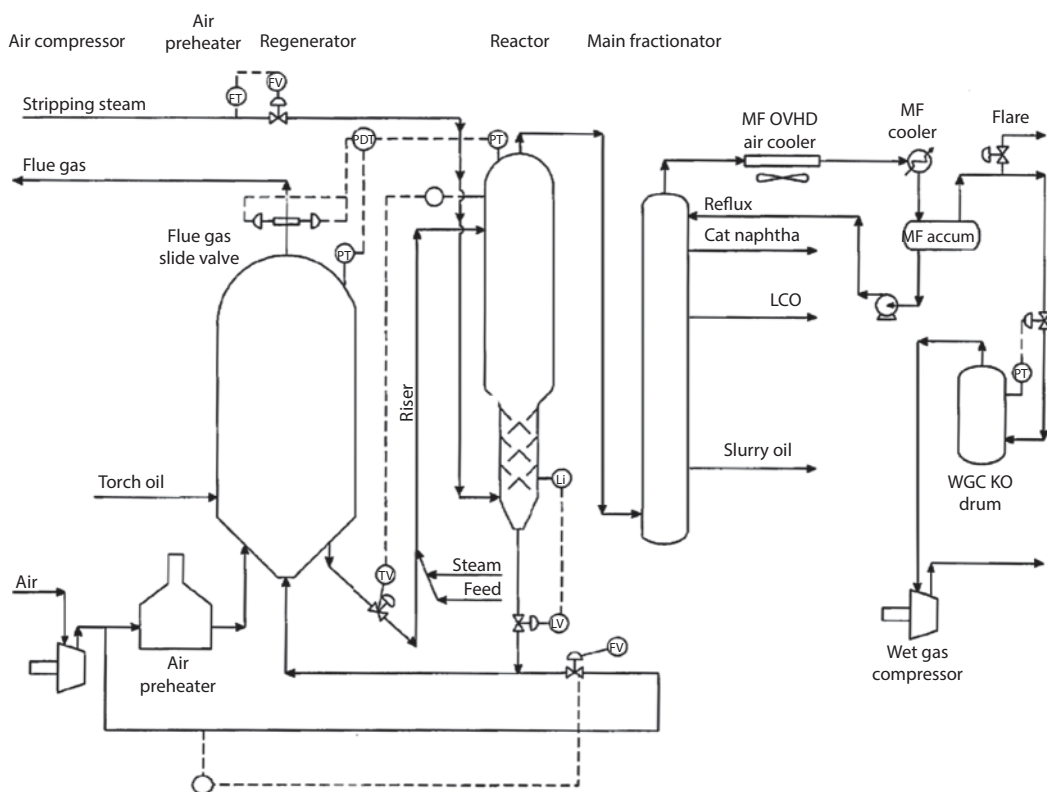


Figure 8.13 Typical Process & Instrumentation diagram of an FCC unit. [FV = flow control valve, FT = flow transmitter, KO = knock out drum, LI = level indicator, LV = level control valve, MF = main fractionator, OVHD = overhead, PDT = pressure differential transmitter, PT = pressure transmitter, TV = temperature control valve.] (Source, Sadeghbeigi, Reza, *Fluid Catalytic Cracking Handbook*, 3rd ed., Elsevier, 2012.)

Table 8.8 Comparison of Fluid, Thermafor, and Houdry Catalytic Cracking Units [1].

	FCC	TCC	HCC
Reactor space velocity	1.1–13.4 ^a	1–3 ^b	1.5–4 ^b
Catalyst-to-oil ratio (Cat/Oil)	5–16 ^c	2–7 ^d	3–7 ^d
Recycle/fresh feed, vol	0–0.5	0–0.5	0–0.5
Catalyst requirement, lb/bbl feed	0.15–0.25	0.06–0.13	0.06–0.13
Cat. crcl. rate, ton cat./bbl total feed	0.9–1.5	0.4–0.6	0.4–0.6
On-stream efficiency, %	96–98		
Reactor temp., °F	885–950 ^e	840–950	875–950
°C	475–510	450–510	470–510
Regenerator temp., °F	1200–1500	1100–1200	1100–1200
°C	650–815	595–650	595–650
Reactor pressure, psig (barg)	8–30 ^e (0.54–2.0)	8–12 (0.54–0.8)	9–10 (0.6–0.8)
Regenerator pressure, psig, (barg)	15–30 (1–2)		
Turndown ratio			2.1
Gasoline octane, clear			
RON	92–99	88–94	88–94
MON	80–85		

^a lb/hr/lb^b v/hr/v^c wt^d vol^e One company has operated at 900 °F and 40 psig to produce a 98% RON (clear) gasoline with a C₃–650 °F liquid yield of 120 vol % on feed (once-through) there was approximately 90% yield of the C₅–650 °F product.

Two dependent operating variables useful in a discussion of other variables are conversion and catalyst-to-oil (Cat/Oil) ratio. Conversion is a measure of the degree to which the feedstock is cracked to lighter products and coke during processing in the FCC. It is defined as 100 percent minus the volume percent yield of light cycle oil (LCO) and heavier liquid products. In general, as conversion of feedstock increases, the yields of LPG, dry gas and coke increase, while the yields of LCO and fractionator bottoms decrease; gasoline yield either increases, decreases or remains constant depending on the situation. The catalyst-to-oil ratio (Cat/Oil) is the ratio of catalyst circulation rate to charge rate on a weight basis. At a constant charge rate, Cat/Oil increases as catalyst circulation increases. At constant riser temperature, conversion increases as Cat/Oil increases due to the increased contact of feed and catalyst.

8.7 Material and Energy Balances

The material and energy balances around the reactor and regenerator are calculated by defining the input and output streams.

8.7.1 Material Balance

The input and output streams to the reactor (Figure 8.14) are:

Reactor input:

- Oil feed (VGO) to the riser: F (BPD) or m_f (lb/h)
- Injection steam: S_{in} (lb/h).
- Regenerated catalyst: m_{cat} (lb/h)

Reactor output:

- Masses of products m_i as calculated from FCC yield correlations. These correlations require some feed properties such as: API, sulfur content and degree of severity expressed as conversion
- Spent catalyst circulation rate m_{scat} (lb/h)
- Steam present in cracked products, S_{out} (lb/h)

Thus, a material balance around the reactor is [10]:

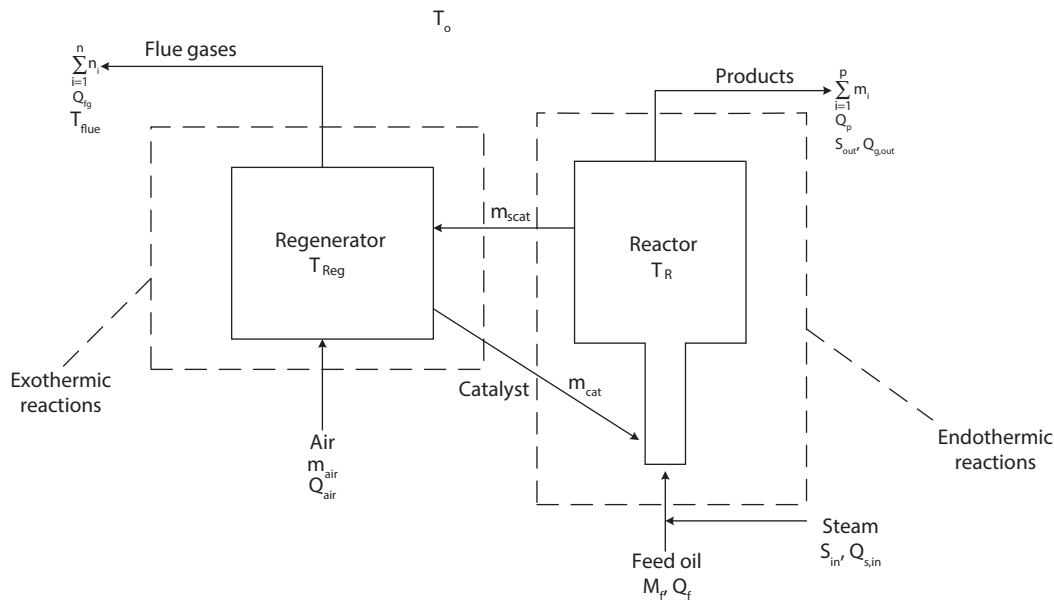


Figure 8.14 Input and output streams for reactor and regenerator in FCC unit.

$$m_f + S_{in} + m_{cat} = \sum_{i=1}^p m_i + S_{out} + m_{scat} \quad (8.27)$$

where p is the total number of vapor products and assuming S_{in} does not condense and is present in the exiting vapor products at the same rate (S_{in} = S_{out}), m_i is the mass of each product that can be calculated using the FCC correlations. The product coke is present in spent catalyst. Thus

$$m_{coke} = m_{scat} - m_{cat} \quad (8.28)$$

Eq. 8.27 can be written as:

$$m_f = \sum_{i=1}^p m_i + m_{coke} \quad (8.29)$$

Regenerator Material Balance:

Regenerator input:

- Spent catalyst circulation rate m_{scat} (lb/h)
- Air for coke burning m_{air} (lb/h).

Regenerator Output:

- Flue gases n_i (lb/h)
- Regenerated catalyst m_{cat} (lb/h)

The material balance around the regenerator:

$$m_{air} + m_{scat} = \sum_{i=1}^N n_i + m_{cat} \quad (8.30)$$

where n_i is the mass of each gas produced from the coke burning which may contain CO₂, CO, H₂O, SO₂, N₂ and O₂ (from excess air).

8.7.2 Energy Balance

Reactor Heat Balance

Heat input:

- Heat of feed oil Q_F (Btu/h) at inlet feed temperature (T_f)
- Heat of steam injected Q_s (Btu/h) at T_s
- Heat of regenerated catalyst Q_{cat} (Btu/h) at regenerator outlet temperature (T_{Reg}).

Heat output:

- Heat in vapor products, Q_p (Btu/h) at reactor outlet temperature (T_R)
- Heat of spent catalyst Q_{scat} (Btu/h) at T_R
- Heat of exit stream Q_{s,out} (Btu/h) at T_R

Then the energy balance at a reference temperature T_o, can be expressed as:

$$\begin{aligned} & m_f C_{p,f} (T_f - T_o) + m_f (-\Delta H_R) \\ & + m_{cat} C_{p,cat} (T_{Reg} - T_o) + S_{in} C_{ps} (T_s - T_o) \\ & = (T_R - T_o) \sum m_i C_{P,i} + m_{scat} C_{P,scat} (T_R - T_o) \\ & + S_{out} C_{ps} (T_R - T_o) \end{aligned} \quad (8.31)$$

Since, $m_{\text{coke}} = m_{\text{scat}} - m_{\text{cat}}$ and $S_{\text{in}} = S_{\text{out}}$, then equation (8.31) becomes

$$\begin{aligned} & m_f C_{p,f} (T_f - T_o) + m_f (-\Delta H_R) \\ & + m_{\text{cat}} C_{p,\text{cat}} (T_{\text{Reg}} - T_R) + S_{\text{in}} C_{ps} (T_s - T_R) \\ & = (T_R - T_o) \sum m_i C_{p,i} + m_{\text{coke}} C_{p,\text{coke}} (T_R - T_o) \end{aligned} \quad (8.32)$$

Regenerator Heat Balance

The heat in the reactor-regenerator section is supplied by the burning of coke in the regenerator. The heat from the combustion of the coke primarily performs the following [11]:

1. Heats the spent catalyst from the reactor temperature to the regenerator temperature (after regeneration-, the hot catalyst flows out to heat the preheated feed to the reactor temperature and provides heat for the endothermic cracking reaction).
2. Heats the air used for combustion to the flue gas temperature.
3. Heats the coke from the reactor temperature to the regenerator temperature.
4. Provides the heat loss to the surrounding.

Inputs required

1. Regenerator flue gas compositions on dry basis (Orsat analysis).
2. Air flow rate to regenerators and air temperature.
3. Catalyst temperature from reactor and first regenerator.
4. Flue gas temperature leaving the regenerators.
5. Heat of formation of CO_2 , SO_2 , H_2O and CO
6. Specific heat, (C_p in Btu/lb. $^\circ\text{F}$ [kcal/kg. $^\circ\text{C}$]) of the catalyst, coke and flue gas at corresponding temperatures.

Steps Involved

1. Calculate average molecular weight of the dry flue gas.
2. Calculate weight formed during coke burning and calculate wet flue gas composition through stoichiometric calculations.
3. Calculate the average molecular weight of the wet flue gas and wet flue gas quantity

corresponding to 100 t-moles of dry flue gas (by adding the water formed with the dry flue gas quantity).

4. Calculate actual rate of wet flue gas from actual rate of air using the nitrogen balance.
5. Calculate coke burned in the regenerator.
6. Calculate heat liberation per mole of the flue gas from the heat formation of CO_2 , CO , H_2O
7. Calculate total heat liberation based on actual wet flue gas flow.
8. Perform heat balance around regenerator to calculate catalyst circulation rate.

Heat input:

- Heat of spent catalyst Q_{scat} (Btu/h) at T_R
- Heat of input air for coke burning Q_{air} (Btu/h) at T_{air}
- Heat of coke combustion q_{coke} (Btu/h)
- **Heat output:**
- Heat of flue gas Q_{fg} (Btu/h) at T_{fluc}
- Heat of regenerated catalyst Q_{cat} (Btu/h) at T_{Reg}

Therefore, the heat balance around the regenerator can expressed as:

$$\begin{aligned} & m_{\text{air}} C_{p,\text{air}} (T_{\text{air}} - T_o) + m_{\text{coke}} C_{p,\text{coke}} (T_R - T_o) \\ & + m_{\text{scat}} C_{p,\text{cat}} (T_R - T_o) + q_{\text{coke}} \\ & = (T_{\text{Flue}} - T_o) \sum n_i C_{p,gi} + m_{\text{cat}} C_{p,\text{cat}} (T_{\text{Reg}} - T_o) \end{aligned} \quad (8.33)$$

8.8 Heat Recovery

Fuel and energy costs are the principal direct costs of refining crude oil and due to the ever fluctuation and increase in crude oil and natural-gas prices, there is a need to conserve fuel by the efficient utilization of the energy in the off-gases from the catalytic cracker regenerator. It is easier to control the temperature in the regenerator if the carbon catalyst is burned to carbon dioxide (CO_2) rather than carbon monoxide (CO), but much more heat is given off and the regenerator temperature limits may be exceeded. However, a better yield with lower coke laydown and higher gasoline yield is obtained at a given conversion level when burning to carbon dioxide to obtain a lower residual on the catalyst. The hot gases are at high temperatures [1100–1250 $^\circ\text{F}$ (595–675 $^\circ\text{C}$) in the former case

and 1250–1500 °F (675–815 °C) in the latter] and at pressures of 15–25 psig (103–172 kPa). Some catalytic cracker units include waste heat boilers that recover sensible heat by steam generation while others use turbines to generate electric power or compress the air used in the regenerator. Some refineries recover the heat of combustion of the carbon monoxide in the flue gas by installing CO-burning waste heat boilers in place of that using sensible heat of the gases. Pinch technology is increasingly employed in the efficient utilization of the energy in the various units of the refinery as this is reviewed later in the text. Assuming a regenerator flue gas discharge temperature 1000 °F (538 °C) and pressure of 20 psig (138 kPa), the available horsepower per pound per second of gas flow for the various schemes is [1]:

	hp	kW
Waste heat boiler only	45	34
Power recovery only	78	58
Power recovery plus waste heat boiler	106	79
CO-burning waste heat boiler	145	108
Power recovery plus CO-burning waste heat boiler	206	154

8.9 FCC Yield Correlations

The FCC units are flexible in processing all types of hydrocarbon streams that are complex mixtures in which the mixing processes are not always efficient to ensure completely homogeneous blends. FCC feeds are blends of atmospheric and vacuum gas oils (VGOs), atmospheric residues; coker and visbreaking gas oils (VGOs), hydrocracking residues, hydrotreated gas oils (HGOs), and residues, furfural extracts, demetalized oil (DMO), etc. One of the problems in the refineries is the lack of physical-chemical analyses for proper feed characterization, as it is important to predict the impact of changing feedstock quality on product yield, operating conditions (heat balance) and product quality.

The feed quality of FCC depends on several factors: quality and type of crude processed by the crude distillation units, other processing units, products from other processes such as thermal conversion units, e.g., delayed coking, coking, visbreaking, hydrogen addition units like gas oil (GO) and residue hydrotreaters and hydrocracking of gas oil. Product streams from lubricant production are also sent to the FCC unit.

The potential yields of the feed can be determined by chemical composition, and these potential yields are determined using properties typically analyzed in the refinery laboratories, such as specific gravity, distillation, sulfur content, refractive index, etc.

Navarro *et al.* [16] conducted studies on more than 100 types of FCC feeds, where the hydrocarbons were analyzed by saturate, aromatic, resin and asphaltene (SARA) analysis. This is a method that divides crude oil components according to their polarity, mass spectrometry (MS), ultraviolet-visible spectroscopy (UV-Vis) and hydrogen nuclear magnetic resonance (1H-NMR) to quantify hydrogen (H₂) content, which is an important property of FCC feeds. The feeds were analyzed under a reaction temperature of 980 °F (527 °C), reaction time of 30 sec., feed flow of 3 g/min, catalyst-to-oil (Cat/Oil) ratio of 4, 6 and 8 and using deactivated catalysts. The catalysts were deactivated in the absence of metals as the study was to evaluate the interaction of the active sites of the catalyst (matrix and zeolite) with the different hydrocarbon types in the selected feeds, and metal contaminants [nickel (Ni) and vanadium (V)] interfering with the reactions of hydrogen transfer, dehydrogenation and catalyst activity.

Feed Classification

Navarro *et al.* [16] studied feeds and used the correlation index (CI) and Hydrogen content (H₂) to determine FCC feed composition. CI is a property developed to classify crudes and petroleum fractions by the U.S. Bureau of Mines and is expressed as:

$$CI = 473.7 \text{ Sp.Gr.} + 48,640 / (T + 273) - 456.8 \quad (8.34)$$

where

T is the mid-boiling point in °C, and Sp.Gr. is specific gravity. CI ranges between 0–100, e.g., n-heptane = 0, cyclohexane = 50 and benzene = 10. Therefore, low CI values for hydrocarbon compounds correspond to be paraffinic feeds; values close to 50 are typical of naphthenic feeds, and higher values are of feeds that have large proportions of aromatic hydrocarbon compounds.

Navarro *et al.* [16] studied feeds with a wide °API range: between 11.4–32.4, which is equivalent to hydrogen content between 9.5% and 14.25% and a CI ranging from 24–88, as the wide range comprises all of the combined feeds and different components used

in the different FCC units worldwide. A correlation between CI and hydrogen content is expressed by:

$$H_2, \% = 15.7243 - 0.06798 \times CI \quad (8.35)$$

Figure 8.15 shows a strong correlation between H_2 and CI with a correlation coefficient of 1.0.

Another property that defines feed quality is the saturate content, which is defined by the sum of paraffinic and cycloparaffinic (naphthenic) hydrocarbons. The chemistry of the cracking reactions, the interactions with the active sites of the catalyst, catalyst morphology to allow diffusion through the pore system, the mechanical and operating conditions of the FCC units require these hydrocarbons to be converted into valuable products, namely gasoline and LPG at an efficiency of ~90%. Thus, it is important to determine and quantify the saturated hydrocarbon content in FCC feeds as expressed by:

$$\begin{aligned} \text{Saturate content \%} \\ = 1 / \left[0.15498 - 0.05378 \ln(\%H_2) \right] \quad (8.36) \end{aligned}$$

Figure 8.16 shows a plot of the saturate content. The lowest H_2 and saturate value belong to the heavy cycle oil (HCO), which in some FCC units, is sent to the riser as recycled. Additionally, the highest values belong to the combined feeds of excellent quality and hydrocracking (HCK) residues.

Other hydrocarbons in the feed are the aromatics, which cannot be cracked due to the difficulty in accessing the active sites of the catalyst. These hydrocarbons are normally dealkylated, i.e., the lateral paraffinic chains are broken along with the cycloparaffinic rings attached to the aromatic ring. In these hydrocarbons,

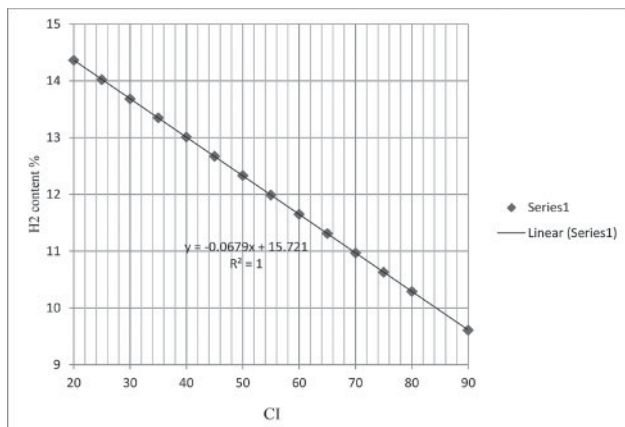


Figure 8.15 Feed classification.

monoaromatics are dealkylated, and the monoaromatic ring with minor lateral groups is sent to the naphtha fraction, providing a good octane rating. The correlation between the H_2 content and aromatic concentration of the FCC feeds is expressed by:

$$\begin{aligned} \text{Aromatic content, \%} = & -95.1947 + 33.86928 \times (H_2) \\ & - 1.82886 \times (H_2)^2 \quad (8.37) \end{aligned}$$

Figure 8.17 shows the correlation between the H_2 content and aromatic concentration of the FCC feeds. The calculations using Eqs. 8.36 and 8.37 were validated by analyzing several feeds using mass spectrometry (MS), which shows the full distribution of the hydrocarbons in the crude oil. Table 8.9 summarizes the comparative distribution of the hydrocarbons in hydrocracking (HCK) residue and vacuum coker gas oil (VCGO). The table lists the properties of H_2 content, °API and sulfur content. Furthermore, when H_2 is added, the saturate content of the HCK residue is high, while the aromatic content is low. Correspondingly, the vacuum coker gas oil (VCGO) is quite the contrary; the aromatic content increases, and saturate concentration decreases. The hydrocarbon distribution shows the behavior of the two feeds when sent to the FCC riser. The HCK residue increases gasoline and LPG

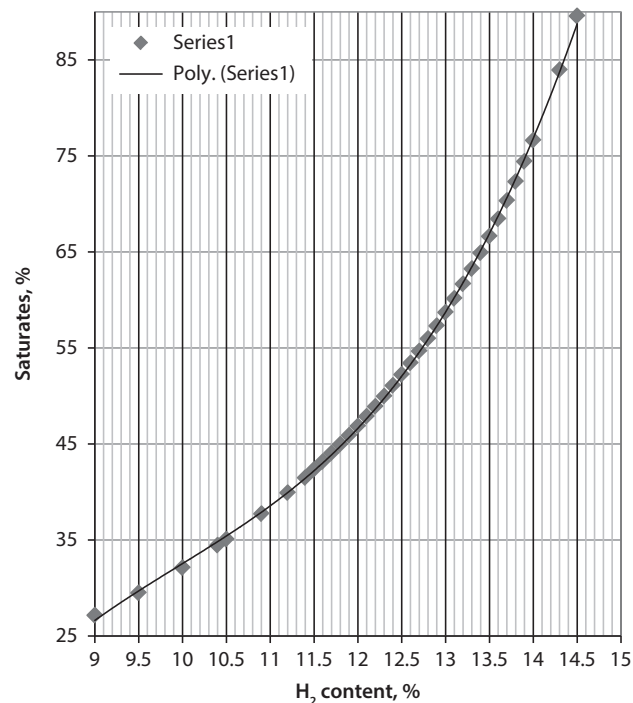


Figure 8.16 Saturate content.

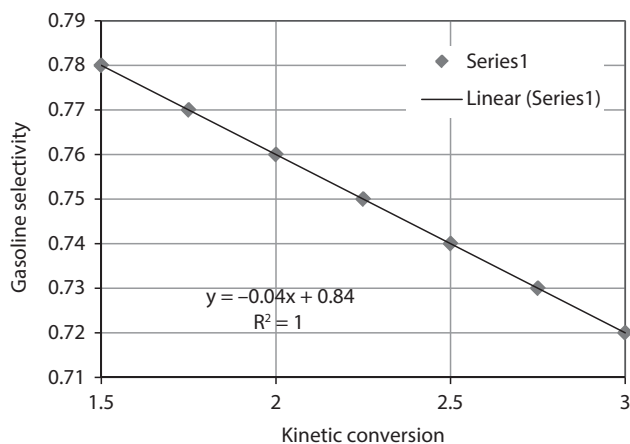


Figure 8.17 Gasoline selectivity vs. kinetic conversion.

Table 8.9 Hydrocarbon distribution by Mass Spectrometry (MS) [16].

	HCK residue	CC-VGO
Hydrogen content, %	14.04	11.66
API gravity, °API	32.67	15.51
Sulfur content, %	0.02	3.55
Paraffins (C _n H _{2n+2})	30.63	2.03
Monocycloparaffins (C _n H _{2n})	32.57	12.00
Dicycloparaffins (C _n H _{2n-2})	14.53	10.83
Tricycloparaffins (C _n H _{2n-4})	6.43	7.47
Tetracycloparaffins (C _n H _{2n-6})	0.33	3.70
Total saturate, %	84.50	36.03
Aromatics		
Alkylbenzenes (C _n H _{2n-6})	4.53	5.73
Benzocycloparaffins (C _n H _{2n-8})	2.70	5.17
Benzodicycloparaffins (C _n H _{2n-10})	0.60	4.97
Total monoaromatics	7.83	15.87
Naphthalenes (C _n H _{2n-12})	0.47	3.33
Other diaromatics (C _n H _{2n-14})	1.80	15.33
Total diaromatics	2.27	18.67
Total Triaromatics	4.77	17.83
Total tetraaromatics	0.20	2.60
Total aromatics %	15.07	54.97
Thiophenes, (C _n H _{2n-4})S,	0.00	0.53
benzothiophenes (C _n H _{2n-8})S,	0.47	5.43
dibenzothiophenes (C _n H _{2n-16})S,	0.00	3.10
Total sulfurized aromatics, %	0.47	9.06

yield and it cools the regenerator as Δ coke make is low. Conversely, due to its high diaromatic content, the vacuum coker gas oils (VCGOs) increase light cycle oil (LCO) yield, while triaromatics and tetraaromatics are bottom (slurry) and coke precursors. Furthermore, the high level of S-containing compounds in coker gas oil explains its high sulfur content.

8.10 Estimating Potential Yields of FCC Feed

Gasoline yields and the conversion obtained for each feed at three severities, i.e., the three Cat/Oil ratios were linearized and used to graph gasoline selectivity (gasoline yield/conversion) as a function of kinetic conversion ($C/100-C$), where C is the conversion obtained from Figure 8.17.

Navarro *et al.* [16] determined the maximum conversion from the H₂ content of the feed by:

$$CF = 85.87257 / \left[1 + 399.7161 \exp(-0.6393 H_2) \right] \quad (8.38)$$

Figure 8.18 shows that the majority of the feeds used in the FCC units have a maximum conversion > 70%, where lower values are related to coker gas oils and heavy cycle oils (HCO).

Maximum gasoline yield

The potential maximum gasoline is defined as the yield at the maximum conversion point, which is guided by the chemical component of the feed and the distribution of the hydrocarbons present. It is essential for the refiners to know this value when optimizing the FCC unit to obtain the potential yield. The maximum gasoline yield can be predicted directly based on H₂, saturate content and correlation index. Using Eq. 8.39, the maximum gasoline yield can be determined by:

$$\text{Maximum gasoline, \%} = 46.457 + 0.6382(CI) - 0.011(CI)^2 \quad (8.39)$$

Figure 8.19 illustrates the relationship between the maximum gasoline yield and the correlation index (CI). Figure 8.19 shows that most FCC feeds have a correlation index (CI) between 35 and 60 for a maximum gasoline yield that can range from 45–56%, where the higher values are from highly paraffinic, hydrotreated gas oils, and hydrocracked residues.

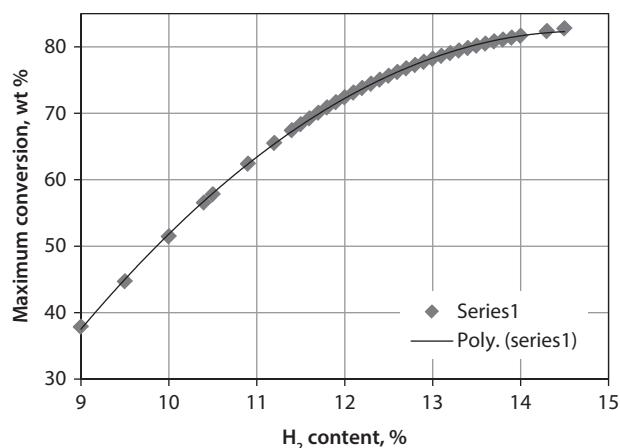


Figure 8.18 Maximum conversion vs. H₂ content, %.

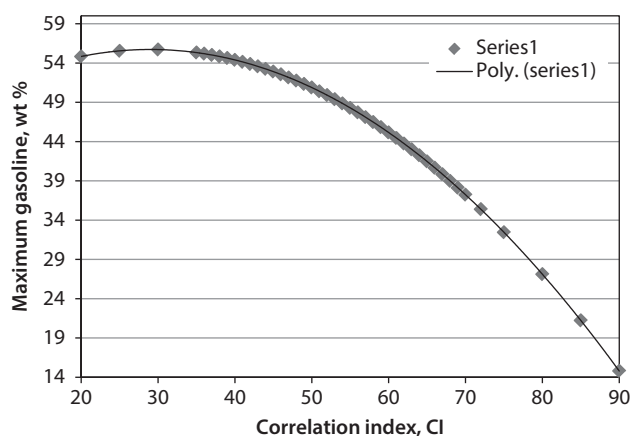


Figure 8.19 Maximum gasoline yield vs. correlation index.

Other parameters such as the yields of LPG, LCO and Δ coke have been reported by Navarro *et al.* [16]. They inferred that the behavior of the feeds and the components in FCC units are governed by chemical composition, type and distribution of hydrocarbon families. The H₂ content of FCC feeds is an important property to define and study; that the conversion factor, i.e., conversion at the maximum gasoline conversion point is an important property in defining FCC feed quality, Δ coke is an important property to define feed impact on heat balance and catalyst coke selectivity, and that these parameters can be employed to optimize the FCC unit. The most important properties to characterize an FCC feed are: density at 15 °C, distillation (D -1160, SimDis), refractive index, nitrogen (N) and sulfur (S) contents and Conradson carbon residue (CRR).

FCC products are commonly reported on an inert-free basis as the volume and weight fractions of the fresh feed. In a rigorous weight balance, gasoline, LCO, slurry oil yields, and unit conversion are reported based on fixed cut points. The common cut points are 430 °F (221 °C) TBP cut points for gasoline and 670 °F (354 °C), TBP cut point for LCO. Using fixed cut points isolates the reactor yields from the distillation system performance.

Conversion is defined as the volume or weight percent of feedstock converted to gasoline and other lighter products, including coke. However, conversion is typically determined by:

Conversion %

$$= \frac{\text{Fresh feed} - \left(\begin{array}{l} \text{LCO product} + \text{HCO product} \\ + \text{slurry oil product} \end{array} \right)}{\text{Feed}} \times 100 \quad (8.40)$$

The yields of the products in FCC are obtained by the regression of plant data compiled by Maples [8] using a zeolite catalyst. Table 8.10 shows yield correlation that requires target conversion (LV%), feed API and sulfur in the feed. These correlations have been provided by Fahim *et al.* [10] and have not been substantiated by other researchers in this field. Conversion is defined as the percentage of the oil feed that has been cracked into lighter fraction than gasoline and lighter products.

$$\text{CONV \%} = \left(\frac{\text{volume of oil feed} - \text{volume of cycle stock}}{\text{volume of oil feed}} \right) \times 100 \quad (8.41)$$

The recycle stock is the purpose of the feedstock, which is not cracked to fractions lighter than gasoline, e.g., for 75% conversion, the cycle stock is 25%.

Conversion from LV % to wt % of hydrocarbon products:

$$\text{Product wt \%} = 0.8672 \times \text{Product LV \%} - 0.9969 \quad (8.42)$$

The recycle stock is the portion of the feedstock, which is not cracked to fractions lighter than gasoline. For example, for 75% conversion, the cycle stock is 25%.

Example 8-2

A feed of 30,000 BPD of AGO (650–850 °F) having an API of 25 and a sulfur content of 0.25 wt %, is mixed with another of feed of 20,000 BPD of VGO (850–1050 °F) that has an °API of 20 and a sulfur content of 0.4wt %. They are used as a feed to FCC unit. Use the FCC correlations to find the material balance around the reactor unit. Assume a conversion of 75 LV %.

Solution

Figure 8.20 shows a schematic of the input and output streams to the reactor.

AGO: °API = 25, SpGr = 0.904

Density of AGO

$$= 0.904 \times 62.4 \frac{\text{lb}}{\text{ft}^3} \times \frac{\text{ft}^3}{7.4805 \text{ gal}} \times 42 \frac{\text{US gal}}{\text{bbl}}$$

$$= 316.7 \text{ lb / bbl}$$

$$\text{Flowrate} = 30,000 \frac{\text{bbl}}{\text{day}} \times 316.7 \frac{\text{lb}}{\text{bbl}} \times \frac{1 \text{ day}}{24 \text{ h}}$$

$$= 395,875 \frac{\text{lb}}{\text{h}}$$

VGO: °API = 20, SpGr = 0.934

Density of VGO

$$= 0.934 \times 62.4 \frac{\text{lb}}{\text{ft}^3} \times \frac{\text{ft}^3}{7.4805 \text{ gal}} \times 42 \frac{\text{US gal}}{\text{bbl}}$$

$$= 327.23 \text{ lb / bbl}$$

$$\text{Flowrate} = 20,000 \frac{\text{bbl}}{\text{day}} \times 327.23 \frac{\text{lb}}{\text{bbl}} \times \frac{1 \text{ day}}{24 \text{ h}}$$

$$= 272,692 \frac{\text{lb}}{\text{h}}$$

Sulfur in AGO: = 395,875 × 0.25/100 = 990 lb/h.

Sulfur in VGO: = 272,692 × 0.4/100 = 1091 lb/h.

Sulfur in Feed: = (2081/668,567) × 100 = 0.311 %.

Conversion

$$= \left(\frac{\text{Vol. of feed} - \text{Vol. of cycle stock}}{\text{Vol. of feed}} \right) \times 100$$

$$= 75\%$$

Cycle stock = unconverted portion below gasoline = (LCG + HCGO) = 25%

°API mixture

Total feed = 668,567 lb/h

SpGr for AGO = 0.904 and SpGr for VGO = 0.934

Then SpGr for mixed feed

$$= \frac{30,000}{(30,000 + 20,000)} (0.904)$$

$$+ \frac{20,000}{(30,000 + 20,000)} (0.934)$$

$$= 0.916$$

$$\text{°API} = \frac{141.5}{\text{SpGr}} - 131.5 = \frac{141.5}{0.916} - 131.5$$

This gives feed °API = 23.0

A summary of the feed mixture is shown in Table 8.11a, and using the data and the yield correlations from Table 8.10, the material balance and product properties are calculated as shown in Table 8.11b.

Example 8-3

Calculate the catalyst circulation rate for the FCC unit by carrying out a heat balance around the regenerator as shown in Figure 8.21.

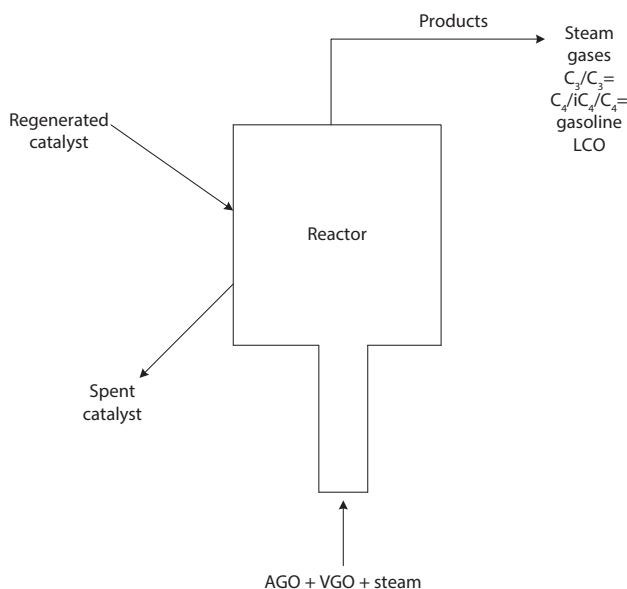


Figure 8.20 Reactor input and output streams.

Table 8.10 FCC yield correlations [10].

Products	Correlation
Coke wt%	$0.05356 \times \text{CONV} - 0.18598 \times \text{API} + 5.966975$
LCO LV%	$0.0047 \times \text{CONV}^2 - 0.8564 \times \text{CONV} + 53.576$
Gases wt%	$0.0552 \times \text{CONV} + 0.597$
Gasoline LV%	$0.7754 \times \text{CONV} - 0.7778$
iC ₄ LV%	$0.0007 \times \text{CONV}^2 + 0.0047 \times \text{CONV} + 1.40524$
nC ₄ LV%	$0.0002 \times \text{CONV}^2 + 0.019 \times \text{CONV} + 0.0476$
C ₄ ⁼ LV%	$0.0993 \times \text{CONV} - 0.1556$
C ₃ LV%	$0.0436 \times \text{CONV} - 0.8714$
C ₄ ⁼ LV%	$0.0003 \times \text{CONV}^2 + 0.0633 \times \text{CONV} + 0.0143$
HCO wt %	$100 - \text{CONV} - (\text{LCO LV}\%)$
wt % S in Gases	$3.9678 \times (\text{wt \% S in feed}) + 0.2238$
wt % S in LCO	$1.04994 \times (\text{wt \% S in feed}) + 0.00013$
wt S in HCO	$1.88525 \times (\text{wt \% S in feed}) + 0.0135$
S in coke ^a	$(\text{lb/h S in feed} - \text{lb/h S in gases} - \text{lb/h S LCO} - \text{lb/h S HCO})/\text{lb/h of Coke}$
Gasoline API	$-0.19028 \times \text{CONV} + 0.02772 \times (\text{Gasoline LV}\%) + 64.08$
LCO API	$-0.34661 \times \text{CONV} + 1.725715 \times (\text{Feed API})$

^aAssuming no sulfur in gasoline

Table 8.11a Feed properties.

Stream	BPD	°API	lb/h	wt % S	lb S/h
AGO	30,000	25.0	395,875	0.25	990
VGO	20,000	20.0	272,692	0.40	1091
		23.0	668,567		2081

Table 8.11b Yields and properties of products.

		wt % S	lb/h
Coke, wt%	$0.05356(75) - 0.18598(23.0) + 5.966975$	5.7	38,108
LCO, LV%	$0.0047(75)^2 - 0.8564(75) + 53.576 = 15.8$	12.7	84,908
Gases wt%	$0.0552(75) + 0.597$	4.7	31,423
Gasoline LV%	$0.7754(75) - 0.7778$	57.4	383,757
iC ₄ LV%	$0.0007(75)^2 + 0.0047(75) + 1.40524 = 5.7$	3.95	26,408
nC ₄ LV%	$0.0002(75)^2 + 0.019(75) + 0.0476 = 2.6$	1.26	8424
C ₄ ⁼ LV%	$0.0993(75) - 0.1556 = 7.3$	5.3	35,434
C ₃ LV%	$0.0436(75) - 0.8714 = 2.4$	1.08	7221
C ₄ ⁼ LV%	$0.0003(75)^2 + 0.0633(75) + 0.0143 = 6.4$	4.55	30,420
HCO wt%	$100 - 75 - 15.8$	9.7	64,851
S in H ₂ S wt%	$3.9678(0.311) + 0.2238$	1.46	459
S in LCO wt%	$1.04994(0.311) + 0.00013$	0.33	280
S in HCO wt%	$1.88525(0.311) + 0.0135$	0.60	389
S in Coke wt%	$(2081 - 459 - 280 - 389)/38,108$	2.50	953
Gasoline °API	$-0.19028(75) + 0.02772(57.4) + 64.08$	51.4	
LCO °API	$-0.34661(75) + 1.725715(23)$	13.7	

Conversion from LV % to wt % of hydrocarbon products:

Product wt % = 0.8672 x Product LV % - 0.9969

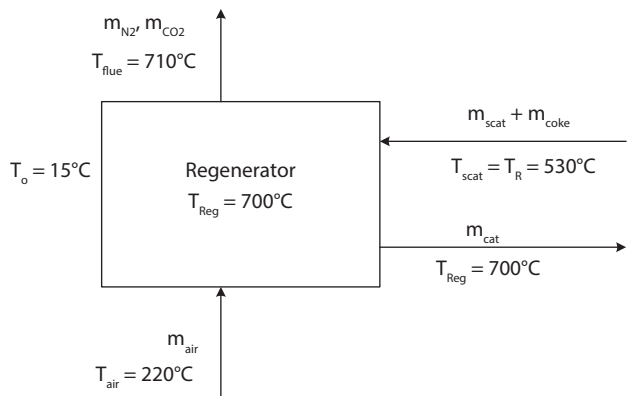


Figure 8.21 Regenerator.

Data:

Assuming the amount of coke produced = 38,000 lb/h
 Heat of combustion of coke, $(-\Delta H_C) = 0.393 \times 10^6$ kJ/kmol.

$C_{p,cat} = 1.11$ kJ/kg.K $C_{p,air} = 29.6$ kJ/kmol.K, $C_{p,N_2} = 32.6$ kJ/kmol.K,

$C_{p,CO_2} = 46.9$ kJ/kmol.K, $C_{p,coke} = 21.1$ kJ/kg.K

The reference/ambient temperature, $T_o = 15^\circ\text{C}$

Solution

Coke produced = 30,000 lb/h = 13,607 kg/h

$$\begin{aligned} \text{Coke} &= 13607 / 12 \left(\frac{\text{kg}}{\text{h}} \times \frac{\text{kmol}}{\text{kg}} \right) \\ &= 1134 \text{ kmol/h} \end{aligned}$$

Mol. Weight = wt/moles

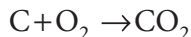
Heat generated by combustion of coke:

$$\begin{aligned} q_{\text{coke}} &= m_{\text{coke}} (-\Delta H_C) \\ &= 1134 \times 0.393 \times 10^6 \left(\frac{\text{kmol}}{\text{h}} \times \frac{\text{kJ}}{\text{kmol}} \right) \\ &= 445.7 \times 10^6 \text{ kJ/h} \end{aligned}$$

Air: (79 % N_2 + 21 % O_2)

Air required: O_2 required/0.21

O_2 required:



From stoichiometry:

$$m_{O_2} = O_2 \text{ required} = 1134 \text{ kmol/h}$$

$$m_{CO_2} = CO_2 \text{ formed} = 1134 \text{ kmol/h}$$

$$\begin{aligned} m_{\text{air}} &= \text{air required} \\ &= 1134 / 0.21 \text{ kmol/h} \\ &= 5400 \text{ kmol/h.} \end{aligned}$$

$$\begin{aligned} m_{N_2} = N_2 \text{ required} &= (0.79 \times 5400) \text{ kmol/h} \\ &= 4266 \text{ kmol/h.} \end{aligned}$$

Therefore, the heat balance from Eq. 8.33 gives:

$$\begin{aligned} m_{\text{air}} C_{p,\text{air}} (T_{\text{air}} - T_o) + m_{\text{coke}} C_{p,\text{coke}} (T_R - T_o) \\ + m_{\text{scat}} C_{p,\text{cat}} (T_R - T_o) + q_{\text{coke}} \\ = (T_{\text{Flue}} - T_o) \sum n_i C_{p,gi} + m_{\text{cat}} C_{p,\text{cat}} (T_{\text{Reg}} - T_o) \end{aligned} \tag{8.33}$$

$$\begin{aligned} 5400 \times 29.6 (200 - 15) + 1134 \times 21.1 (530 - 15) + m_{\text{cat}} \\ \times 1.11 (530 - 15) + 445.7 \times 10^6 \\ = (710 - 15) [1134 \times 46.9 + 4266 \times 32.6] \\ + m_{\text{cat}} \times 1.11 (700 - 15) \end{aligned}$$

$$m_{\text{cat}} = 1.89 \times 10^6 \text{ kg/h} = 1890 \text{ t/h} = 0.53 \text{ t/s}$$

8.11 Pollution Control

Combustion of coke in the FCC regenerator produces several atmospheric pollutants that require controlling. These potential pollutants include carbon monoxide (CO), sulfur oxides (SO_2 , SO_3), nitrogen oxides (NO_x), nickel compounds (Ni) and particulate matter (PM). Furthermore, the flue gases from the FCC are highly polluting since they contain sulfur and nitrogen oxides. Hence, suitable sulfur recovery and effluent treatment measures are important in accordance with regulations. In the U.S., three major regulatory requirements affect the FCC unit flue gas emission controls. These are:

- Continuing application of New Source Performance Standards (NSPS).
- Implementing Maximum Achievable Control Technology (MACTII).
- Implementing the Environmental Protection Agency (EPA) enforcement actions and Consent Decrees.

Carbon Monoxide (CO) Emission

Catalyst leaving the reactor stripper contains 0.5–1.3 wt % coke. This coke has about 7% hydrogen, 93% carbon with traces of organic sulfur and nitrogen compounds. Combustion products from burning coke and some entrained catalyst are constantly moved out of the dense bed into the freeboard region. The entrained catalyst returns to the dense bed via cyclone diplegs.

The flue gas velocity affects the amount of catalyst being entrained in the dilute phase region.

The burning of carbon in the regenerator can be either partial or full combustion. In partial combustion, air rate to the regenerator is controlled either to achieve a concentration of CO in the regenerator flue gas or to maintain a desired regenerator bed temperature. The final concentration of CO is achieved through operation of CO boilers. In full combustion, CO promoter additive and maintaining excess oxygen in the flue gas are used to ensure CO emission of < 500 ppm. For units operating in partial combustion, the concentration of CO in the CO boiler stack depends on the design of CO boiler, firebox temperature, and concentration of incoming CO, stack excess oxygen, residence time of flue gas in the CO boiler and mechanical design of the CO boiler [12].

Many factors affect the CO level in the regenerator flue gas: these are feed quality, catalyst properties, operating conditions, and effectiveness of the air and spent catalyst distribution systems. Regenerator dense bed temperature, regenerator catalyst bed level, catalyst/flue gas residence time in the regenerator, flue gas excess oxygen and the amount/type of CO promoter can affect CO emission.

A heavier FCC feedstock and an active fresh catalyst will increase the regenerator bed temperature and thus promote the combustion of CO to CO₂. Furthermore, the evenness of the air/spent catalyst mixing is extremely essential in ensuring CO compliance, especially with the deep hydrotreated FCC feedstock. There is a trade-off between CO and NO_x levels. Higher CO concentration often lowers the NO_x and vice-versa.

SO_x Emission

Approximately 5–12% of the FCC feed sulfur is converted in the riser and surrounded with the coke on the catalyst. The factors affecting concentration of this coke-laden sulfur depends on the FCC feed sulfur concentration, type of sulfur species, and reactor-regenerator operating conditions. Combustion of this sulfur-laden coke produces > 90 % SO₂, with the remainder largely SO₃. Catalyst additive or flue gas scrubbing is employed to reduce the SO₂ emission. Also, deep hydrotreating of the gas oil feed and or with addition of SO₂-reducing catalyst will reduce SO₂ of < 25 ppm.

The additive is injected separately into the regenerator as the key ingredients of these additives are magnesium oxide (MgO), 40–60%, cerium oxide 12–16% and vanadium oxide 2–5%. Cerium oxide promotes the reaction of SO₂ to SO₃, magnesium captures SO₃

and releases sulfur as H₂S in the reactor. Operating conditions of the regenerator such as partial versus full combustion and excess oxygen level will influence the effectiveness of additive.

Wet gas scrubbing devices are employed to remove particulate and gaseous pollutants. The design attempts to provide good liquid-to-flue gas contact to achieve high removal efficiency (> 95%). Wet gas scrubbers saturate the flue gas stream, thereby creating a water vapor plume, as well as a waste-water stream blow-down that needs to be treated prior to its discharge. This system is effective in neutralizing the SO₂ while removing SO₃ and catalyst particles.

Sulfur Content in Gasoline

Sulfur content in gasoline is an essential regulatory constraint in the refinery, and many methods are employed to reduce the sulfur content in the refinery products. In the case of the FCC unit, a high proportion of the sulfur in the feed leaves the process as a dry gas. The remaining sulfur leaves through the key liquid products.

Sadeghbeigi [3] and Gary *et al.* [1] show that hydrotreating the feed significantly reduces the sulfur content in the non-slurry products, although this may be disadvantageous economically. Additionally, low sulfur may result in an excess low-value residue feeds in the refinery. The refiners look for ways to blend this high-sulfur residue feeds into processing units that can accommodate higher sulfur. Chang *et al.* [21] have considered the situation of a cheaper feedstock such as vacuum residue (VR) is available for blending with the existing vacuum gas oil (VGO) and showed how the sulfur content can be varied to meet the required constraint.

Particulate Matter

Particulate emission limits are expressed in units of milligrams per normal cubic meter (mg/Nm³) of the flue gas. EPA's unit of measurement is pounds of particulate matter per 1,000 pounds of coke burned. Therefore, 1 pound of particulate per 1,000 pounds of coke burned is about 95–125 mg/Nm³, which depends on the mode of catalyst regeneration and the CO₂/CO ratio.

The compliance requirement for the amount of particulates (catalyst and non-catalyst particles) emitted to atmosphere is often expressed as function of the

amount of coke burned in the regenerator. About 90% of FCC units employ some types of separation devices in the regenerator flue gas system to remove residual particles. Some of these devices are:

- Wet flue gas scrubbing.
- Third-stage/fourth-stage cyclone systems.
- Dry electrostatic precipitator.

These devices are well illustrated by Sadeghbeigi [13].

NO_x Emission

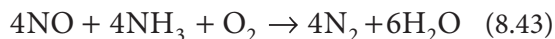
NO_x is nitric oxide (NO) and nitrogen dioxide (NO₂). In the FCC regenerator operating under full combustion mode, over 90% of NO_x is formed as NO with the remainder as NO₂ and nitrous oxide (N₂O). The two main ways that NO_x can be formed are thermally and chemically. Thermal NO_x is formed from fixation of nitrogen in the combustion of air (NO₂ + O₂ → 2NO). The rate of formation of thermal NO_x is a function of temperature > 1500 °F (815 °C), oxygen concentration and residence time. A fraction of NO_x in the regenerator flue gas is thermally produced depending on regenerator bed temperature, catalyst stripper performance and regenerator design.

In full combustion operation in the FCC regenerator, chemical or fuel, NO_x is produced from combustion of nitrogen compounds. About 50% of feed nitrogen is converted and deposited as coke on the spent catalyst entering the regenerator and about 95% of these nitrogen compounds are directly or indirectly converted to elemental nitrogen (N₂) with the remaining 5% as nitrogen oxides such as NO. The regenerator flue gas can contain intermediate nitrogen compounds such as NH₃ and HCN when the partial mode of catalyst regeneration is applied to the absence of excess oxygen.

The catalyst additives are solid catalyst particles that can be used to reduce NO_x emission. Their effectiveness can vary from no reduction up to 50% reduction. The most effective NO_x additives use copper (Cu) as the reducing element. Copper can increase the FCC gas yields by about 10%. The hydrogen fraction of the absorber off-gas can be doubled with the use of these additives, and the CO emission can be increased as well as the regenerator afterburning. Additionally, the effectiveness of an SO₂-reducing additive can be adversely affected using these NO_x reducing additives [13].

Another process that reduces NO_x to < 20 ppm is selective catalytic reduction (SCR). A typical SCR unit

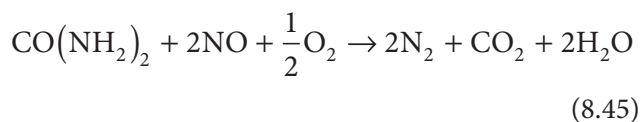
uses a solid catalyst, containing vanadium/tungsten oxides coated on a titanium substrate. Ammonia is used as part of neutralizing NO as follows:



The flue gas operating temperature is between 550–750 °F (288–399 °C) and the process requires a minimum of 1% excess oxygen in the flue gas for the reaction to proceed to completion.

The advantages of SRC are very high NO_x removal (as much as 97%) with lesser ammonia slips (< 10 ppm). Disadvantages include safety concerns with storage and handling of ammonia, high capital cost, high operating conditions and a higher flue gas pressure drop, especially if the catalyst bed is plugged. Furthermore, are requirements of a large plot space and the potential for sulfur to precipitate as ammonium bisulfate (NH₄)HSO₄, a white crystalline solid.

The selective noncatalytic reduction (SNCR) process can be used to reduce NO_x emission. Ammonia (NH₃) or 50% urea solution CO(NH₂)₂ is injected into the hot flue gas, using air or steam as a carrier gas. When urea is used, it first decomposes to ammonia, as the overall reaction is:



The reaction favors good mixing and adequate residence time. SNCR is suitable in the temperature range of 1,800–2,000 °F (982–1,093 °C); therefore, the process is applicable for FCC units that employ CO boilers and/or a fired furnace in their flue gas system. Sadeghbeigi [13] has reviewed various technologies for treating pollutants of FCC units.

8.12 New Technology

The demands for higher gases (LPG and olefins) and the decline for residual oils have been a major drive in improving FCC process. Furthermore, replacing diesel fuels to gasoline will cause FCC technology to reduce its production in favor of lighter products as well as environmental aspects in improving FCC units. The following processes have been developed and commercialized.

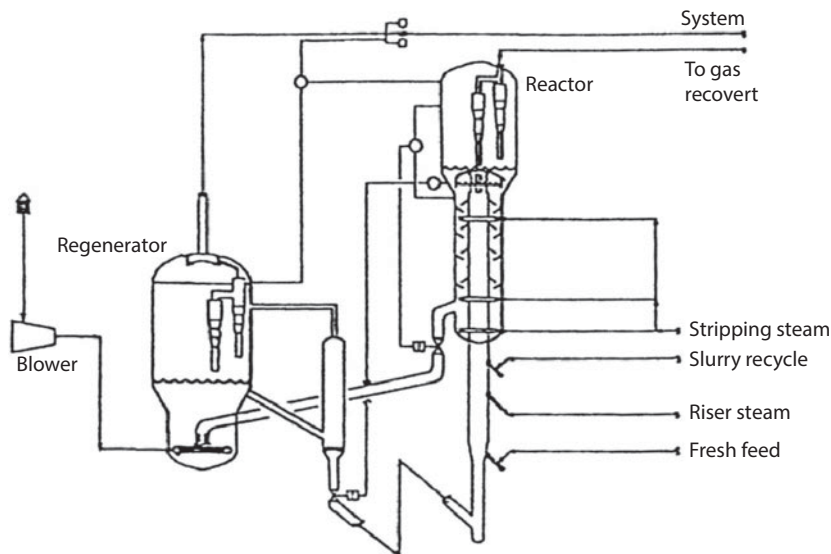


Figure 8.22 Deep catalytic cracking process flow diagram (Courtesy of Stone & Webster Engineering Corporation © 1977 Stone & Webster Engineering Co.)

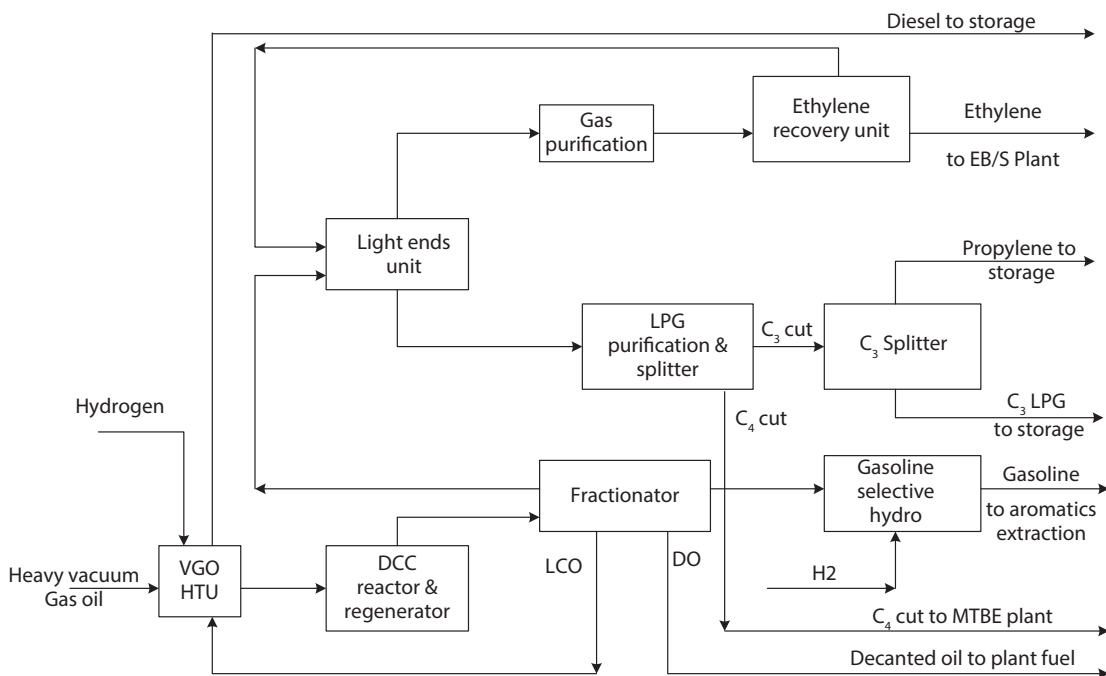


Figure 8.23 DCC plant petrochemicals integration. (Courtesy of Stone & Webster Engineering Corporation, © 1977 Stone & Webster Engineering Corporation).

8.12.1 Deep Catalytic Cracking

A deep catalytic cracking unit (DCC) is designed to produce gasoline from vacuum gas oil (VGO). DCC uses heavy vacuum gas oil (HVGO) as feedstock and has the same features as the FCC unit but with the following differences: special catalyst, high catalyst-to-oil

ratio, higher steam injection rate, operating temperature, and residence time and lower operating pressure.

In the DCC unit, the hydrocarbon feed is dispersed with steam and cracked using a hot solid catalyst in a riser, and enters a fluidized bed reactor. A known injection system is employed to achieve the desired temperature and catalyst to oil contacting. This maximizes the

Table 8.12 Operating parameters.

Item	Deep catalytic cracking (DCC)	Fluidized catalytic cracking (FCC)	Steam cracking (SC)
Typical Residence Time, sec	10–60	1–30	0.1–0.2
Catalyst/Oil	9–15	5–10	
Steam, wt % of feed	10–30	1–10	30–80
Reactor temperature, oF	950–1,070	950–1,020	1,400–1,600
Pressure, psig	10 - 20	15–30	15

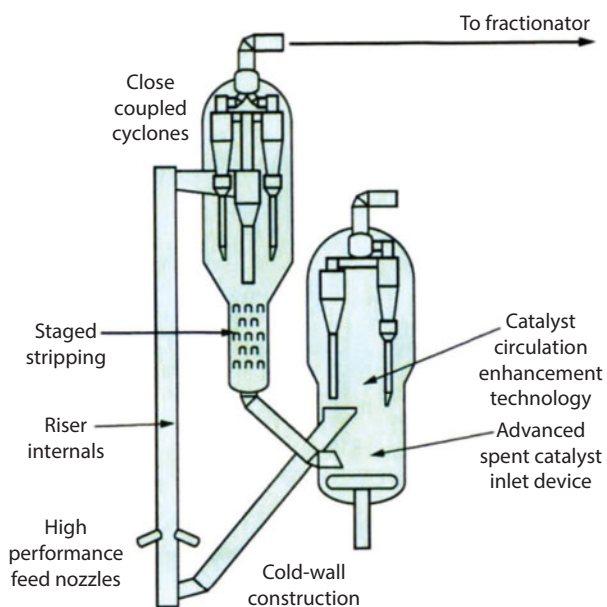


Figure 8.24 Shell's Fluid catalytic cracking (Source: Gulf Publishing Co., 2011).

selective catalytic reactions. The vaporized oil and catalyst flow up the riser to the reactor where the reaction conditions are varied to complete the cracking process. The cyclones located in the top of the reactor effect the separation of the catalyst and the hydrocarbon vapor products. The steam and reaction products are discharged from the reactor vapor line and enter the main fractionator where further processing ensures the separation of the stream into valuable products.

The formed coke on the catalyst particles during cracking reduces its activity and selectivity. The spent catalyst passes into a stripping zone where steam is used to displace the entrained and adsorbed hydrocarbons, which leave the reactor with the products. Stripped catalyst particles are transported into the regenerator where the particles are contacted with air

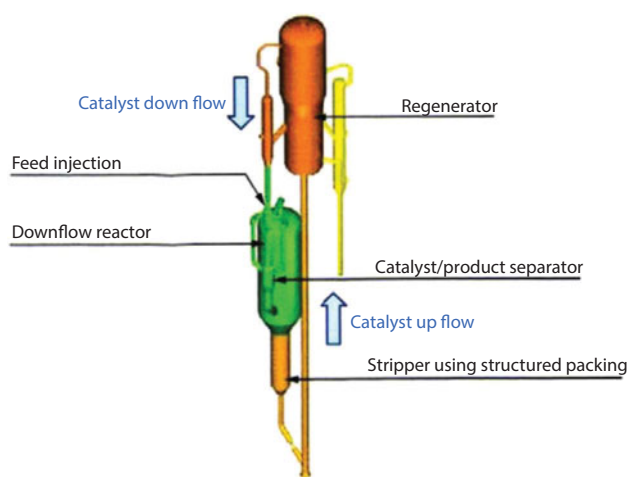


Figure 8.25 HS-FCC unit. (Source: Gulf Publishing Co., 2011).

under controlled conditions. The regeneration process is the same as in the FCC unit. The DCC unit has been shown to produce polymer grade propylene from heavy gas oils, and it produces three and half times more propylene and less than half the gasoline than a conventional FCC unit. Figure 8.22 illustrates a DCC unit, and Figure 8.23 represents a typical DCC plant that produces propylene, which is integrated into a petrochemical complex. Table 8.12 compares the operating variables of the deep catalytic cracking (DCC), fluidized catalytic cracking (FCC) and steam cracking (SC) units.

8.12.2 Shell's Fluid Catalytic Cracking

The FCC unit (Figure 8.24) converts heavy distillates and residues into high-value products, including selective propylene production when required. Shell's high-performance feed nozzle system feeds hydrocarbons to a short contact time riser. The design ensures good mixing and rapid vaporization into the hot catalyst

stream. Cracking selectivity is enhanced by the feed nozzles and riser-internals, which reduce catalyst back mixing while reducing overall riser pressure drop.

The riser termination design incorporates reliable close-a couple of cyclones that provide rapid catalyst/hydrocarbon separation. It minimizes post-riser cracking and maximizes desired product yields, with no slurry clean up required. Stripping begins in the staged stripper, equipped with high-capacity baffle structure.

A single-stage partial or full-burn regenerator delivers excellent performance at low cost. Proprietary internals are used at the catalyst inlet to disperse catalyst and the catalyst outlet to provide significant catalyst circulation enhancement. Catalyst coolers can be added for more feed stock flexibility. The cyclones systems to the reactor and regenerator are robust, reliable and efficient. Flue gas cleanup can be incorporated with Shell's third-stage separator.

8.12.3 Fluid Catalytic Cracking High Severity

This is an alliance comprising of Saudi Aramco, JX Nippon Oil & Energy Corp (JX), King Fahd University of Petroleum and Minerals (KFUPM) and Axens/Shaw. The high-severity FCC unit (Figure 8.25) produces up to 25% of propylene by converting heavy hydrocarbon feedstock under severe FCC conditions, using a novel downflow reactor concept. 3,000 barrels per day are being processed using HS-FCC process, and along with propylene, butenes, gasoline and aromatics are produced as valuable by-products. This can be increased towards propylene and aromatics by further downstream conversion of its less desired products using proven technology approaches.

The HS-FCC unit comprises a downflow reactor, high-reaction temperature, short contact time and high catalyst-to-oil ratio (Cat/Oil). Operating the HS-FCC process at high temperature and high Cat/Oil ratio results in two competing cracking reactions: thermal and catalytic cracking. Thermal cracking contributes to dry gas production while catalytic cracking contributes to enhancing propylene yield and propylene.

The catalyst and the feed flow downward along with gravity to minimize back mixing in the reactor and to obtain a narrower distribution of residence time that allows maximizing intermediate products such as gasoline and light olefins. The downflow reactor allows a higher catalyst-to-oil ratio because the lifting of catalyst by vaporized feed is not required, as the downflow reaction ensures plug flow without back mixing.

The HS-FCC process is operated under higher reaction temperature 1022–1202 °F (550–650 °C) than conventional FCC units. Under these reaction temperatures, thermal cracking of hydrocarbon also takes place concurrently with catalytic cracking resulting in increased undesirable byproducts of dry gas and coke. Short contact time (< 0.5 sec.) of feed and product hydrocarbons in the downer minimize thermal cracking. Undesirable successive reactions such as hydrogen transfer, which consumes olefins are suppressed. In order to attain short residence time, the catalyst and products have to be separated immediately at the reactor outlet. For this purpose, a high-efficiency, short-residence time product separator was developed and is capable of suppressing the side reactions (e.g., oligomerization and hydrogenation of light olefins) along with coke formation.

Compensating a drop in conversion due to short contact time, the HS-FCC unit is operated at high catalyst-to-oil ratio, and therefore, an enhanced contribution of catalytic cracking over thermal cracking is obtained. Further high catalyst-to-oil ratio maintains heat balance and helps to minimize thermal cracking over cracking, and hydrogen transfer reactions.

8.12.4 Fluid Catalytic Cracking for Maximum Olefins

The Lummus technology Indmax FCC (I-FCC) process cracks a wide range of feedstocks such as virgin or hydrotreated gas oil including lube oil extract, coker gas oil, and residue into light olefins. The products, i.e., light olefins (principally propylene, but also ethylene and butylenes), high-octane gasoline, blending

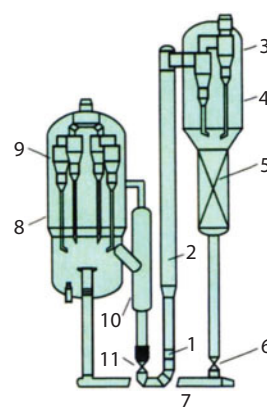


Figure 8.26 The Indmax FCC process (Source: Gulf Publishing Co., 2011).

components, and distillate. This process is flexible as it allows for maximum propylene, propylene plus ethylene, or propylene plus gasoline.

The catalyst is unique, which is proprietary, multi-component, multi-functional catalyst formulation that promotes selective component cracking to provide very high conversion and yield of light olefins. It is highly metals tolerant and produces low Δ coke and dry gas—properties that are particularly important when processing residue to make light olefins.

The I-FCC unit operates at a riser reactor temperature from 1040–1112 °F (560–600 °C), catalyst-to-oil ratio from 12–20, and lower hydrocarbon partial pressure compared to conventional FCC operations. The I-FCC process incorporates an advanced reaction system, high-efficiency catalyst stripper and a mechanically robust, single-stage fast fluidized bed regenerator (Figure 8.26).

Oil is injected into the base of the riser via proprietary Micro-jet feed injection nozzles (1), Catalyst and oil vapor flow upwards through a short-contact time, tall vertical riser (2), where raw oil feedstock is cracked under optimum conditions. Reaction products exiting the riser are separated from the spent catalyst using a direct-coupled cyclone system (3). Product vapors are routed directly to the fractionation column; this eliminates non-selective post-riser cracking and maintains the optimum product yield slate. The spent catalyst that contains small quantities of hydrocarbon is discharged from the diplegs of the direct-coupled cyclones into the cyclone containment vessel (4). The catalyst flows down into the stripper containing modular grid (MG) baffles (5).

Trace hydrocarbons entrained with spent catalyst are removed in the MG stripper using stripping steam. The MG stripper efficiently removes hydrocarbons at low steam rate. The net stripper vapors are routed to the fractionator via specially designed vents in the direct-coupled cyclones. Catalyst from the stripper flows down the spent-catalyst standard pipe and through the slide valve (6). The spent catalyst is then transported in dilute phase to the center of the regenerator (8) through a square-bent spent catalyst transfer line (7). This arrangement provides the lowest overall unit elevation. Catalyst is regenerated by efficient contacting with air for complete combustion of coke. For residue-containing feeds, the optional catalyst cooler is integrated with the regenerator. The resulting flue gas exists via a cyclone (9) to energy recovery/flue gas treating. The hot regenerated catalyst is withdrawn via an external withdrawal well (10). The well allows

independent optimization of catalyst density in the regenerated catalyst standpipe, maximizes slide valve (11) pressure drop and ensures stable catalyst flow back to the riser feed injection zone.

8.13 Refining/Petrochemical Integration

The global trends in fuel consumption favor diesel over gasoline, and with the decline in demand and restrictions of government regulations (e.g., EPA, OSHA), there is a surplus of FCC gasoline. At the same time, there is an increase in demand for various petrochemicals such as propylene and aromatics. FCC unit has successfully produced propylene by high severity operation, but the gasoline yield from these units has been neglected.

Catalytic cracked gasoline contains a high level of olefins, some sulphur and appreciable amount of aromatics. The aromatics were deemed unwanted due to the olefin and sulfur impurities in this stream. However, new technology is being commercialized to separate the aromatics from FCC gasoline in order to use them directly for downstream applications. Additionally, the olefin fraction can be converted into aromatics through a simple fixed-bed reaction system. Therefore, all of the gasoline components are efficiently made into high-value petrochemicals.

This new technique reduces the sulfur and olefins content in the gasoline moving towards an environmentally acceptable applications. This combination of technology is much more efficient than what some operators use, which recycles FCC gasoline to the reforming unit.

8.14 Metallurgy

The FCC units operate at high temperatures with contact involving the gas and solid catalyst, so special metallurgy is required for equipment used [11]:

The reactor shell is made of 1¼ Cr–0.5 Mo or 2¼ Cr–1 Mo.

The riser is a cold wall made of carbon steel with insulating refractory lining inside.

The spent catalyst line is made of carbon steel with refractory lining inside (cold wall).

The regenerator is made of carbon steel with a corrosion allowance. The inside has insulating refractory lining.

The regenerated catalyst stand pipe is made of carbon steel with refractory lining inside (cold wall).

The regenerated flue gas line is made of carbon steel with insulated refractory lining inside.

The regenerated cyclones, air grid and diplegs are made of SS 304.

The regenerated air grid is made of SS 304 with a refractory lining on the outside.

The main column bottom pump casing is made of SS 410 and impeller is made of abrasion resistant cast iron (with 25% Cr, 2.5% Ni, and 3% Mo).

8.15 Troubleshooting for Fluidized Catalyst Cracking Units

The following provides a checklist for fluidized catalytic cracking units [12].

Catalyst Stream Stripping

- Remove oil of catalyst
- Increased regenerator air
- Higher regenerator temperature
- Loss product yield
- Hydrothermal deactivation
- Alter steam rate to test
- Change riser temperature with steam
- Check CO/CO₂ ratio

Raise Riser Temperature

- Higher feed temperature
- Lower cycle oil recycle
- Reduce feed rate
- Increase catalyst circulation
- Raise regenerator temperature

Catalyst Poisoning Effect on Gas Compressor

- May cause flow reversal
- Lowers region slide valve ΔP
- Lowers molecular weight and causes surge
- Increase hydrogen make
- Increased Ni content of feed

Catalyst Deactivation

- Thermal deactivation
- Hydrothermal deactivation
- Metals poisoning (Ni + V)
- Loss of antimony (Sb) flow
- Caustic of salt
- Differentiating between catalyst problems and refractory feed
- Effect of fresh catalyst

Reducing Regenerator Temperature

- Lower feed preheat
- Inject water through torch oil nozzles
- Cut air blower discharge temperature
- Add water to riser feed
- Recycle naphtha and Light cycle oil to riser

Cyclone Malfunctions

- Unsealed diplegs
- Plugged diplegs
- Dipleg failure
- Plugging cyclone volute
- Hole in cyclone body

Catalyst Regeneration Problems

- Coke makes coke
- Damaged air grid
- Insufficient air
- Excessive regenerator velocity
- Poor spent catalyst initial distribution
- Check air grid pressure drop
- After burn problems

Air Blower Problems

- Air intake filters plugged
- Pressure restriction of blower discharge
- Increased ambient temperature
- Compressor rotor fouled
- Blower turbine running slow
- Wet gas compressor problems
- Fractionator condensers plugged
- High regenerator slide valve ΔP

Fluid catalytic cracking units experience some degree of coking and fouling, as coke can be found on the reactor internal walls, reactor top head section, inside/outside of the reactor cyclones, reactor overhead vapor line, main fractionator bottom and fouling of the slurry bottoms pumparound circuit. These anomalies impact throughput or cracking severity. The following steps are taken to minimize coking/fouling in the FCC unit [12].

Avoid dead spots: Coke grows wherever there is a cold spot in the system. Use “dry” dome steam to purge hydrocarbons from the stagnant area above the cyclones. Dead spots cause thermal cracking.

Minimize heat losses from the reactor plenum and the transfer line: Heat loss will cause condensation of heavy components of the reaction products. Insulate as much of the system as possible; when insulating flanges, verify that the studs are adequate for the higher temperature.

Improve the feed/catalyst mixing system and maintain a high conversion: A properly designed feed/catalyst injection system, combined with operating at a high conversion, will crack out high boiling feeds that otherwise could be the precursors for the formation of coke.

Ensure cracking temperature is high enough to vaporize/crack very high boiling fraction of the feedstock:

Follow proper startup procedures: Introduce feed to the riser only when the reactor system is adequately heated up. Local cold spots cause coke to build up in the reactor cyclones, the plenum chamber, or the vapor line.

Keep the tube velocity in the bottoms pumparound exchanger(s) < 5 ft/s (1.5 m/s): Putting the bundles in parallel for more heat recovery may lead to low velocity.

Hold the main column liquid bottoms temperature under 700°F (371°C): For residue operation, this temperature should be < 650 °F (343 °C). Use “pool quench” to control the main column bottoms temperature.

Minimize the bottoms level and residence time of the hot liquid.

Ensure adequate liquid wash to shed trays or grid packing to minimize coking in the bottom of the main column.

Utilize a continuous-cycle oil flush into the inlet of the bottoms exchanger: This keeps the asphaltenes in solution and increases tube velocity.

Verify that no fresh feed is entering the main column: Feed can enter the main column through emergency bypasses, through the feed surge tank vent line or safety relief valve.

The following examples provide leading indicators for high reactor pressure alarm and main fractionator slurry pumps cavitations.

Coking and Fouling

Leading indicator: High reactor pressure alarm

Evidences	Possible Causes
• DCS trend	• Loss of main fractionator overhead cooling
• Feed rate had to be cut back	• Salting of the main fractionator trays or packing
• Blower surging	• Coke deposition in the reactor vapor line
	• Coke deposition in the rough cut cyclone outlet tubes

Coking and Fouling

Leading indicator: Main fractionator slurry pumps cavitation

Evidences	Possible Causes
• Low slurry pumparound rate	• Coke buildup in the main fractionator bottom
• High slurry pumparound return temperature	• Catalyst carryover from the reactor
• High bottoms temperature	• Bottoms temperature too high
• Reactor pressure climbing	• Light components entrained with slurry oil

Increase in Afterburn–High Regenerator Cyclone Outlet Temperatures

Leading indicator: Two out of six cyclone outlet temperatures at 50°F (28°C) higher

Evidences	Possible Causes
• DCS	• Broken air distributor alarms
• Feed rate is cut back	• Broken spent catalyst deflector/distributor
	• Erratic catalyst flow from stripper
	• Low regenerator bed level
	• Low regenerator bed temperature

Operation options to reduce afterburning include the following:

- Maximum feed preheat temperature.
- Using HCO or slurry oil recycle.
- Optimizing the use of CO combustion promoter.
- Ensuring catalyst circulation from reactor is steady.
- Ensuring catalyst stripping steam rate has been optimized.
- Adjusting combustion air rates to each air distributor.
- Changing the ratio of combustion air and carrier rates.
- Increasing regenerator pressure.
- Increasing the regenerator bed level, while ensuring it does not affect the catalyst loss rate.
- Optimizing the flue gas excess oxygen.

8.16 Health, Safety and Environment Considerations

Fire Prevention and Protection: Liquid hydrocarbons in the catalyst or entering the heated combustion air stream should be controlled to avoid exothermic reactions. Because of the presence of heaters in catalyst cracking units, the possibility exists for fire due to a leak or vapor release. In cases where insulation is not feasible and in areas where firewater hose streams cannot reach, fire protection, including concrete or other insulation on columns and supports, or fixed water spray or fog systems should be in place.

In some processes, caution must be taken to prevent explosive concentrations of catalyst dust during recharge or disposal. When unloading any coked

catalyst, the possibility exists for iron sulfide (FeS) fires. Iron sulfide will ignite spontaneously when exposed to air and therefore must be wetted with water to prevent it from igniting vapors. Coked catalyst may be either cooled below 120 °F (49 °C) before it is dumped from the reactor, or dumped into containers that have been purged and inert with nitrogen and then cooled before further handling.

Safety: Regular sampling and testing of the feedstock, product, and recycle streams should be performed to ascertain that the cracking process is working as intended and that no contaminants have entered the process streams. Corrosive or deposits in the feedstock can foul gas compressors. Inspections of critical equipment, including pumps, compressors, furnaces and heat exchangers should be conducted as required. When processing sour crude, corrosion may be expected where temperatures are below 900 °F (482 °C). Corrosion occurs where both liquid and vapor phases exist, and at areas subject to local cooling such as nozzles and platform supports.

When processing high-nitrogen feedstock, exposure to ammonia and cyanide may occur, subjecting carbon steel equipment in the FCC overhead system to corrosion, cracking or hydrogen blistering. These effects may be minimized by water wash or corrosion inhibitors. Water wash may also be used to protect overhead condensers in the main column subjected to fouling from ammonium hydrosulfide (NH₄)SH. Inspection should include checking for leaks due to erosion or other malfunctions such as catalyst build-up on the expanders, coking in the overhead feeder lines from feedstock residues, and other unusual operating conditions.

Health: Because the catalytic cracker is a closed system, there is normally little opportunity for exposure to hazardous substances during normal operations. The possibility exists of exposure to extremely hot 700 °F (371 °C) hydrocarbon liquids or vapors during process sampling or if a leak or release occurs. Additionally, exposure to hydrogen sulfide (H₂S) and/or carbon monoxide (CO) gas may occur during a release of product or vapor.

Catalyst regeneration involves steam stripping and decoking and produces fluid waste streams that may contain varying amounts of hydrocarbon, phenol (C₆H₅OH), ammonia (NH₃), hydrogen sulfide (H₂S), mercaptan (RSH), and other materials depending upon the feedstock, crudes, and processes. Inadvertent formation of nickel carbonyl may occur in cracking

processes using nickel catalysts with resultant potential for hazardous exposures. Safe work practices and the use of appropriate personal protective equipment may be required for exposures to chemicals and other hazards such as noise and heat; during process sampling, inspection, maintenance and turnaround activities; and when handling spent catalyst, recharging catalyst, or if leaks or releases occur.

8.17 Licensors' Correlations

The FCC is usually a licensed process; correlations and techniques are therefore, proprietary to the licensor, although certain data are provided to the clients under the licensor agreement. Such data are often required by the operators of the unit. But these may not be divulged to third parties without the licensor's permission.

Here, we will list the type of data that should be made available to the refinery personnel for operating the unit:

1. Method of calculating the fresh catalyst addition rate.
2. Calculation of metals on equilibrium catalyst.
3. Data on apparent bulk density including:
 - Particle density
 - Skeletal density
 - Surface area
 - Pore volume
4. Catalyst evaluation by the following graphs:
 - Coke yield, wt % vs. conversion to 380 +/90 LV%
 - C₂ yield, wt % vs. conversion to 380 +/90 LV%
 - C₃ yield wt % vs. conversion to 380 +/90 LV%
 - C₄ yield wt % vs. conversion to 380 +/90 LV%
 - Adj. gasoline yields vs. conversion to 380 +/90 LV%
 - Gasoline selectivity vs. conversion to 380 +/90 LV%
5. Calculation methods for:
 - Reactor/regenerator heat balance
 - Combustion heat of coke
 - Reactor heat calculations
 - Overall heat balance
 - UOP characterization 'K' for calculations with data graphs
6. Reactor temperature, pressure, catalyst-to-oil ratio vs. yield and conversion graphs.
7. Residence time calculation

Table 8.13 Routinely monitored properties used for model development and calibration [21].

Feed	Products	FCC	Fractionation
• Flow rate	• Yield	• Temperatures	• Temperature profile
• Distillation curves	• Composition (for light products)	• (feed, riser outlet, regenerator bed and flue gas)	• Pressure profile
• Specific Gravity	• Density	• Pressure	• Draw rates
• Conradson Carbon Residue (CCR)	• RON/MON	• differential between riser/reactor and regenerator	• Pumparound flow rates and duties
• Sulfur content (S)	• Flash point	• Steam usage	• Set points (usually temperatures)
• Metal content (Fe, Na, Vi, V)	• Sulfur content	• Main air blower flow rate	
• Saturates, Resins, Aromatics			
• Asphaltenes (SARA)			

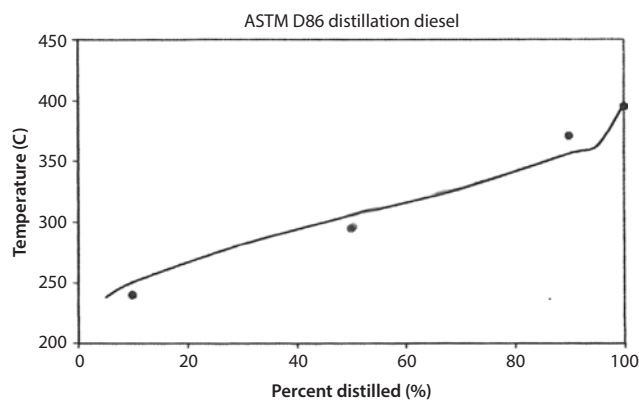


Figure 8.27 ASTM D-86 distillation for the product diesel from the main fractionator (VALID -1) ([Source: Chang, Ai-Fu., *et al.* (21)].

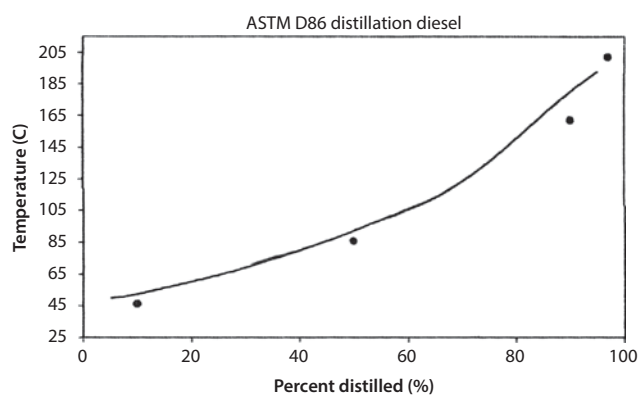


Figure 8.28 ASTM D-86 distillation for the product gasoline from debutanizer column (VALID-1) [Source: Chang, Ai-Fu., *et al.* (21)].

8. Conversion of feed vs. time graph gasoline yield
% of feed vs. time graph.
9. Regenerator severity-kinetics equation.
Effect of carbon level.
Air distribution rate.
Temperature and pressure.
10. Quality and condition of charge.

These and other pertinent instructions such as operating manuals should be provided for the proper operation of the unit. Most of the proprietary data relate to reactor/regenerator side of the process. The recovery side that includes the equipment required to produce the product streams from the reactor effluent as described in this chapter, utilizes conventional techniques in their design and operation evaluation. Further details on the prediction of yields at various severities of operation and feed are illustrated by Jones [22].

8.18 Simulation and Modeling Strategy

Modeling and simulation of FCC depend primarily on data collected while the refinery is in normal operation. Related review of integrated FCC simulation and modeling often relies on pilot plant studies. It is generally difficult to produce a predictive model with plant operation data alone, as the nature of operation means there may be abrupt changes in feed quality or operating parameters, poor measurements due to incorrect calibration or failure of sensors and inconsistent data. Chang *et al.* [21] have outlined the strategy for model development and calibration. Table 8.13 shows routinely monitored properties used for model development and calibration in the FCC.

The evaluation of the model includes comparisons of overall reactor yield, light and heavy product composition, and operating profiles for key equipment in the gas plant. Another set of key indicators are the product

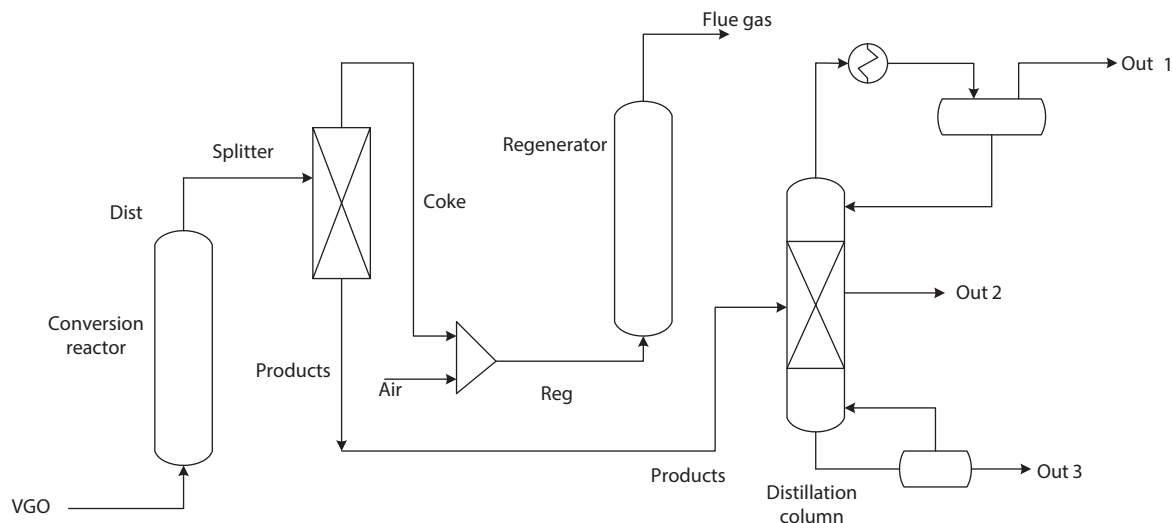


Figure 8.29 UniSim flow diagram of the FCC unit.

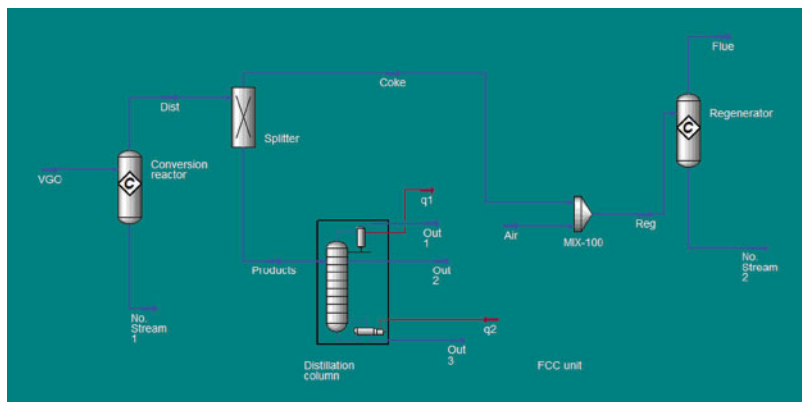


Figure 8.30 A snapshot of process flow diagram of the FCC unit. (Courtesy of Honeywell Process Solution, UniSim Design R433, Honeywell (R) and UniSim (R) are registered trademarks of Honeywell International Inc.).

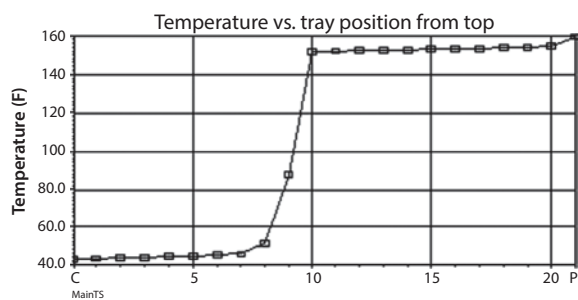


Figure 8.31 Profile of Temperature vs. Tray position of the distillation column of FCC simulation (Courtesy of Honeywell Process Solution, UniSim Design R433).

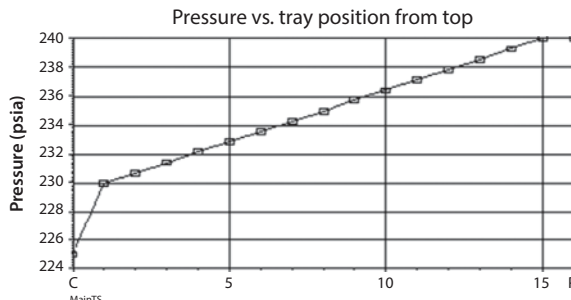
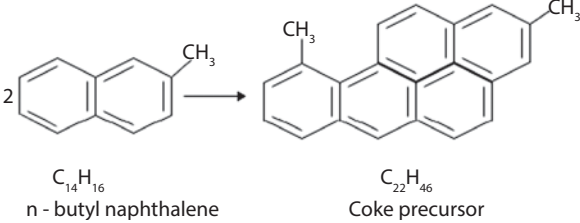


Figure 8.32 Pressure vs. Tray position of the distillation column of FCC simulation (Courtesy of Honeywell Process Solution, UniSim Design R433).

properties of the liquid fuel from the FCC. These properties are density, flash point (volatility), RON/MON (for gasoline), sulfur content and aromatic content, and Chang *et al.* [21] focused in developing their model for

the FCC using these properties. They used the results from the fractionator model to calculate the distillation curves of liquid products for diesel and gasoline as shown in Figures 8.27 and 8.28, respectively.

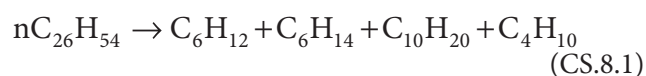
1.	<p>A conversion reactor is used to carry out reactions (CS.8.1) to (CS.8.5) at 950 °F and 25 psia. The product stream is referred to as Dist (Figure 8.29), which is fed to the splitter.</p> $nC_{26}H_{54} \rightarrow C_6H_{12} + C_6H_{14} + C_{10}H_{20} + C_4H_{10} \quad (CS.8.1)$ $C_{10}H_{20} \rightarrow C_6H_{12} + iC_4H_8 \quad (CS.8.2)$ $C_6H_{12} + 3iC_4H_8 \rightarrow 3C_4H_{10} + C_6H_6 \quad (CS.8.3)$  <p style="text-align: center;"> $C_{14}H_{16}$ $C_{22}H_{46}$ n - butyl naphthalene Coke precursor </p> $Hypo - 2000 + 26O_2 \rightarrow 22CO_2 + 8H_2O \quad (CS.8.5)$
2.	The Dist. Stream is split into Hypo-200 as a coke stream and the other products.
3.	Air is injected at 100 °F and 20 psia.
4.	The mixed stream (reg) is sent to the regenerator reactor where coke reacts with oxygen producing hot flue gases (CO_2 , N_2 , H_2O , O_2).
5.	The product stream from the splitter is sent to a fractionating column, where stream components: Out 1, Out 2, Out 3, with components propane (C_3H_8), n-butane (nC_4H_{10}), cyclohexane (C_6H_{12}), cyclodecane ($C_{10}H_{20}$), hexane (C_6H_{14}) and benzene (C_6H_6) are removed.

A Case Study

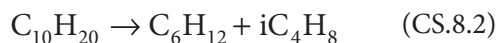
A vacuum gas oil (VGO) feed of 80,000 lb/h is fed to the riser of a FCC unit at 950 °F and 25 psia. Assume that the feed is composed of 95 mol % $C_{26}H_{54}$ paraffin and 5 mol % n-butyl naphthalene ($C_{14}H_{16}$). Perform a simulation on the FCC as shown in Figure 8.29.

The following reactions occur in the riser:

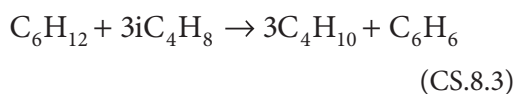
Cracking reaction of paraffin (90% Conversion)



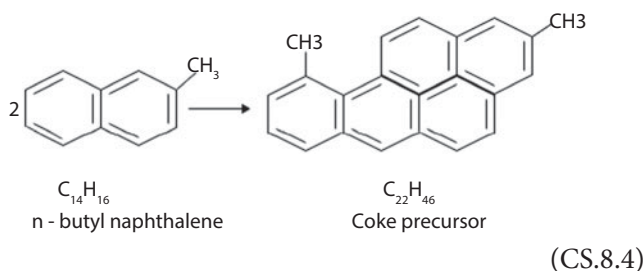
Olefin $C_{10}H_{20}$ is further cracked (95% Conversion)



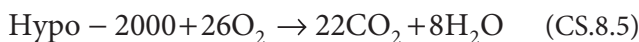
Hydrogen transfer reaction between cyclohexane and isobutane (100% Conversion)



Condensation reaction of coke (100% Conversion)



In UniSim simulation, the coke is defined as a hypothetical component (hypo 2000) with a UNIFAC structure of $[(ACH)_{10}(AC)_8(ACCH_3)_2]$. The coke coming out from the reactor is further burned in the regenerator using air according to the following reaction (100% Conversion):



Solution

The following is carried out in simulating the FCC unit at 80,000 lb/h VGO feed stream to the riser of FCC reactor.

Table 8.14 Summary of FCC simulation results.

Stream composition (mole %)																
Stream name	Feed rate (lb/h)	Temp. (°F)	C ₃	C ₄ H ₁₆	C ₂₆ H ₅₄	C ₁₀ H ₂₀	C ₆ H ₁₄	C ₆ H ₁₂	C ₅ H ₆	n C ₄	Coke	C ₄	O ₂	CO ₂	H ₂ O	N ₂
VGO	80000	950	0.0	5.0	95	0	0	0	0	0	0	0	0	0	0	0
Dist	80000	946.8	0.53	0	0	1.91	20.17	26.29	12.1	38.3	0.61	0	0	0	0	0
Products	78190	951.8	0.53	0	0	1.93	20.29	26.45	12.2	38.6	0	0	0	0	0	0
Coke	1815	896.0	0	0	0	0		0	0	0	1.0	0	0	0	0	0
Air	86550	100	0	0	0	0		0	0	0	0	0	21	0	0	79
Reg	1250	133.0	0	0	0	0		0	0	0	0.22	0	20.95	0	0	78.83
Flue gas	88370	1429	0	0	0	0		0	0	0	0	0	15.3	4.71	1.71	78.32
Out 1	20,210	43.25	1.59	0	0	0	0	0	0	98.4	0	0	0	0	0	0
Out 2	34960	152.1	0.010	0	0	2.85	30.3	39.4	18.2	9.2	0	0	0	0	0	0
Out 3	23010	159.9	0.048	0	0	2.95	30.6	40.9	18.5	7.9	0	0	0	0	0	0

Figure 8.30 shows a snapshot of the simulation using UniSim process simulator. Figures 8.31 and 8.32 show the temperature and pressure vs. tray position profiles of the FCC simulation respectively and Table 8.14 shows a summary of the results. The simulation program (**FCC-akc.usc**) can be accessed from Scrivener dedicated web site of this text.

References

- Gary, James, H., Handwerk, Glenn, E., and Mark, J. Kaiser, *Petroleum Refining Technology and Economics*, 5th ed., CRC Press, Taylor & Francis Group, 2007.
- Wilson, J. W., *Fluid Catalytic Cracking, Technology and Operation*, PennWell Publishing, 1997.
- Sadeghbeigi, Reza, *Fluid Catalytic Cracking Handbook*, 2nd ed., Gulf Publishing Co., 2000.
- Niccum, Philip, K., and Chris R. Santner, Chapter 3.1 KBR Fluid Catalytic Cracking Process, Robert A. Meyers, *Handbook of Petroleum Refining Processes*, 3rd ed., McGraw-Hill, Handbooks, 2003.
- Murcia, A. G., *Oil Gas J.*, 90 (10), pp 68–71, 1992.
- Habib, E. T., *et al.*, *Ind. Eng., Chem. Prod. Res. Dev.*, 16, p 291, 1977.
- Tominaga, H., and M. Tameki, *Chemical Reaction and Reactor Design*, John Wiley & Sons, England, 1997.
- Maples, R. E., *Petroleum Refining Process Economics*, PennWell Publishing Co., Oklahoma, 1993.
- Coker, A.K., Understanding cyclone design, *Chem. Eng. Progr.*, pp 51–55, December 1993.
- Fahim, M. A., Al-Sahhaf, T. A., and A. S. Elkilani, *Fundamentals of Petroleum Refining*, Elsevier, 2010.
- Ashis Nag, *Distillation & Hydrocarbon Processing Practices*, PennWell Corporation, 2016.
- Normal P. Lieberman, *Troubleshooting Process Operations*, 2nd ed., PennWell Books, 1985.
- Sadeghbeigi, Reza, *Fluid Catalytic Cracking Handbook*, 3rd ed., Elsevier, 2012.
- Koermer, G., and M. Deeba, The chemistry of FCC coke formation, *Catal. Rep. Engelhard Corporation*, 7(2), 1991.
- Lieberman, Norman P., *Troubleshooting Process Operations*, 2nd ed., PennWell Publishing Co., 1985.
- Navarro, U, Ni, M and D Orlicki, Clean Fuel, FCC 101: How to estimate product yields cost-effectively and improve operations, *Hydrocarbon Processing*, pp 41–52, February 2015.
- Froment, G. F., and K. B., Bischoff, *Chemical Reactor Analysis and Design*, 2nd, ed., Wiley, 1990.
- Weekman, V. W., Jr., and D. M. Nace, Kinetics of catalytic cracking selectivity in fixed moving and fluid bed reactors, *AIChE J*, 16:397–404, 1970.
- Ancheyta-Juarez, J., Lopez-Isunza, F., Aguilar-Rodriguez, E., and J.C., Moreno-Mayorga, A strategy for kinetic parameters estimation in the fluid catalytic cracking process, *Ind. Eng. Chem. Res.* 36:5170–5174, 1997.
- Maya-Yescas, R., Villafuerte-Macias, E. F., Aguilar, R., and D. Salazar-Sotelo, Sulfur oxides emission during fluidised-bed catalytic cracking, *Chem. Eng., J.*, 106: 145–152, 2005.
- Chang, Ai-Fu, Pashikanti, Kiran and Y.A. Liu, *Refinery Engineering-Integrated Process Modeling and Optimization*, Wiley-VCH, 2012.
- Jones, D.S.J., *Elements of Petroleum Processing*, John Wiley & Sons, 1996.
- Ancheyta, Jorge, *Modeling and Simulation of Catalytic Reactors for Petroleum Refining*, John Wiley & Sons, Inc. 2011.
- Wolf, E. E. and F. Alfani, Catalyst deactivation by coking, *Catal. Rev. Sci. Eng.*, 24: 329–371, 1982.

9

Catalytic Reforming and Isomerization

9.1 Introduction

Catalytic reforming and isomerization are processes that rebuild hydrocarbon structures. These processes are designed to alter the chemical nature of a gasoline feedstock such that the octane number is increased. Cracking is not a viable reaction as it decreases the yield of high-octane gasoline and increases the production of light gases and coke.

Both processes use a high partial pressure of hydrogen in the reactor to promote isomerization reaction and to reduce the deposition of carbon on the catalyst (coking). The naphtha reformer catalyst also promotes the cyclization of paraffins into naphthenes and the dehydrogenation of naphthenes into aromatics. The resulting aromatic compounds have much higher octanes than the feedstock paraffins and naphthenes. These chemical reactions in the reformer and isomerization are provided later in this chapter.

The reforming of naphtha feedstocks over platinum catalysts was first introduced by Universal Oil Products (UOP) with Platforming process in the late 1940s. There are several licensed reforming processes in operation today that employ the use of platinum-based catalysts

to produce aromatic compounds as well as high-octane gasoline blending stock. The reforming process is different from catalytic cracking as the purpose is not to crack the feedstock, but rather to rearrange its molecules to form a product with a higher octane than the feedstock.

The octane of gasoline produced from other refinery units is unchanged, and thus the octane obtained from the naphtha reforming unit is essential for refinery economics. The reformate octane and the use of octane enhancers as MTBE and TAME must be balanced economically. Increasing the reformate octane number invariably reduces the amount of octane enhancers required to make the desired gasoline octane. However, as the reformate octane number increases, the volume of reformate decreases, and it therefore becomes necessary to use octane enhancers to raise the pool gasoline octane without further reduction in total gasoline pool volume.

The increasing demand for unleaded high-octane gasoline has enhanced the use of catalytic reforming. This process produces 30 to 40% of the U.S. gasoline requirements. However, with the restrictions on the aromatic contents of gasoline, this quantity can

be expected to decrease as the U.S. Environmental Protection Agency (EPA) and other countries' governmental bodies impose automobile emissions standards.

Catalytic naphtha reforming maintains its position as a major process in the petroleum refinery with several new units added annually to an installed base of over 250 units worldwide. The processing units provide hydrogen for clean fuels, high-octane reformate product for gasoline and aromatics for petrochemicals production. However, the recent economic climate and the impact of government regulations have impacted the role of the reformer in various regions.

In North America, Europe and Japan, refinery utilizations and reformate demand are generally down due to regulatory demands and market trends. Refiners have responded by reducing the octane and/or throughput to their reformers. However, reforming is still essential to making gasoline and providing hydrogen for hydrotreating various refinery streams and for hydrocracking required for growing diesel demand. Most refiners have indicated that yields are still their major concern regardless of whether the reforming unit is operating at normal or reduced severities. The target is to achieve the most productivity at a given severity. Catalyst activity is also important for process unit flexibility in order to increase severity when needed to take advantage of market opportunities.

The Asia-Pacific region is dominated by China and India and other rapidly growing economies. Fuels and aromatics demand growth in these regions is driving major investment and creating a highly supportive environment for UOP continuous catalyst regeneration (CCR) Platforming process units. The Middle East, with its advantaged economies and low feedstock costs, is also adding reforming capacity for motor fuel and aromatics production. For existing reforming units, increasing the naphtha feed to the reformer can produce additional quantities of gasoline or aromatics. Additionally, more aromatics and hydrogen can be produced by operating at higher severity (i.e., higher temperature and octane operations). These reforming units can attain these types of objectives with more active CCR Platforming catalysts that operate at the lower temperature.

9.2 Catalytic Reforming

The process transforms $C_7 - C_{10}$ hydrocarbons with low octane numbers to aromatic and iso-paraffins, which have high-octane numbers. The change in the boiling

point of the stock passed through the unit is relatively small as the hydrocarbon molecular structures are rearranged to form higher-octane aromatics with a minor amount of cracking. This process increases the octane number of motor gasoline rather than increasing the yield. There is a decrease in the yield because of hydrocracking reactions that take place in the reforming operation and the higher densities of the aromatic compounds containing the same number of carbon atoms as the paraffin in the feed. Figure 9.1 shows a schematic representation of the feedstock, process conditions and the products.

The typical feedstocks to catalytic reformers are heavy straight-run (HSR) naphthas 180–375 °F (82–190°C) and heavy hydrocracker naphthas. These are composed of the four major hydrocarbon groups: paraffin, olefins, naphthenes and aromatics (PONA). Typical feedstock and reformer products have the following PONA analyses (vol%).

Component	Feed	Product
Paraffins	30–70	30–50
Olefins	0–2	0–2
Naphthenes	20–60	0–3
Aromatics	7–20	45–60

The reactions taking place in converting paraffin and naphthenes to higher octane components are cyclization and isomerization. The ease and probability of either of these reactions occurring increase with the number of carbon atoms in the molecules. This is one of the reasons that only the naphthas containing seven to more carbon atoms are used for reformer feed. The LSR naphtha [$C_5 - 180$ °F ($C_5 - 82$ °C)] is largely composed of pentanes and hexanes; the pentanes do not contain enough carbon atoms to make an aromatic ring and the hexanes can be converted into benzene. However, because the benzene content of gasoline is limited by the EPA, the hexane content of the reformer is minimized. Further, hydrocarbons boiling above 400 °F (204 °C) are easily hydrocracked and cause an excessive carbon laydown on the catalyst.

9.3 Feed Characterization

Feeds are characterized by the Watson characterization factor (K_w), naphthenes (N) vol% and aromatics (A) vol%, in which $(N + 2A)$ is defined. Initial boiling point (IBP) and end point (EP) for feeds

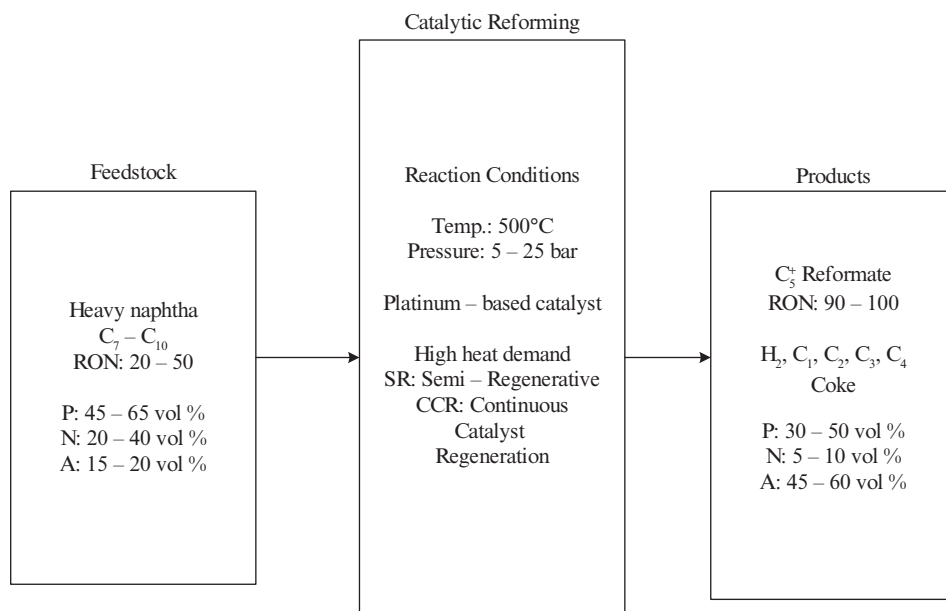


Figure 9.1 Schematic of catalytic reforming process.

Table 9.1 Typical reforming feedstock [19].

ASTM D-86 (vol%)	°C	Group	Paraffin (wt%)	Naphthene (wt%)	Aromatic (wt%)
IBP	76	C ₅	1.00	0.47	–
5%	90	C ₆	6.85	6.66	0.88
10%	94	C ₇	11.25	13.17	2.31
30%	104	C ₈	9.42	14.02	3.02
50%	116	C ₉	7.35	10.79	3.04
70%	131	C ₁₀	4.45	5.31	0.00
90%	152	Total	40.32	50.42	9.25
95%	160	Specific Gravity			0.745
EBP	170	Sulfur/Nitrogen/Halide content (ppm)			0.5/0.5/NA

must be known, and feeds are characterized by the hydrocarbon family and their number of carbon atoms. Naphthenic feeds give a much higher yield than paraffinic feeds. The main feed comes from the hydrotreated heavy naphtha and some from hydrocracked and hydrotreated coker naphthas. Table 9.1 shows the basic compositional analysis of reformer feedstock.

Refiners often consider the total naphthene (N) and aromatic (A) content of the feed as an indicator of how high an octane rating a feedstock can produce. Many correlations for reformer yield exist upon the basis of these indicators. However, Little [3] indicates that these correlations often have included

strong assumptions such as catalyst type and operating conditions.

The feed to the reforming unit is an important process consideration. The feedstock to a reformer is typically a straight-run naphtha cut or hydrotreated gasoline cut from an FCC unit. In general, a feed that has an end boiling point (EBP) of 401–410 °F (205–210 °C) is not included. This feed encourages hydrocracking reactions and excessive coke generation. The feed is usually hydrotreated because sulfur, nitrogen and other trace components can deactivate the catalyst significantly. Many processes may also include several guard reactors to prevent sulfur from entering the reforming unit.

9.4 Catalytic Reforming Processes

The previous reforming processes use three fixed-bed reactors in series, where endothermic dehydrogenation reactions are prevalent in the first two reactors, thus requiring the use of inter-furnaces to heat the effluent to the desired inlet temperature for further reactions in the final reactor. As the catalyst deactivates, exothermic hydrocracking reactions increase and the reheat requirements are decreased. In the final reactor, hydrocracking reactions are significant as there may be a small temperature increase as the catalyst deactivates.

At a certain time in the cycle, it is desirable for the fixed-bed reactors to be off-line and regenerate the catalyst. Regeneration involves burning the coke deposits and treating the catalyst chemically. However, after using the catalyst over a period of time, it is desirable to completely replace it.

Recently, continuous catalytic reforming (CCR) processes have been developed and implemented. Here, the catalyst is circulated through the reactors and regenerated in a continuous cycle, which is similar to the FCC processes. The advantages of CCR are first; the reactors are never taken off-line for the regeneration of the catalyst, second, keeping the catalyst activity level high; the distribution of the products from the reformer is held constant. In non-continuous processes, the catalyst activity declines in the regeneration cycle and the temperature must be increased to maintain the desired reformate properties. As the temperature is increased, the reformate yield declines and the light hydrocarbon and coke production are increased.

Reforming catalysts are poisoned by hydrogen sulfide (H_2S) and other sulfur compounds, nitrogen, and oxygen. Thus, the naphtha feedstock to a reformer is pretreated in a mild hydrotreating operation to remove these impurities prior to reforming. While the majority of reformer feedstocks are virgin (uncracked) naphtha from the crude distillation unit (CDU), other naphtha stocks of suitable boiling point range are acceptable after hydrotreating to remove the catalyst poisons and saturate the unstable olefinic materials.

Figure 9.2 shows a typical three-bed reformer process flowsheet. The heavy naphtha feed is combined with recycle hydrogen and preheated by exchange with the hot reactor effluent from the last reactor. The preheated naphtha/hydrogen feed is brought to the desired inlet temperature for the first reactor in the main furnace. The effluent from the first reactor is reheated to the desired inlet temperature for the second reactor in the first inter-heater, and the effluent from the second reactor are again reheated to the desired inlet temperature for the third reactor in the second inter-heater. The mixture of product and light gases from the last reactor is cooled and separated into hydrogen-rich gas and the liquid products. A portion of the hydrogen-rich gas is withdrawn from the unit to maintain a hydrogen balance, and the remaining hydrogen is recycled to the first reactor.

The naphtha reformer is used to upgrade a significant portion of the crude oil from low-octane heavy naphtha (gasoline) that is unsuitable for motor gasoline into a high-octane gasoline blending component. It is also used to produce aromatics, e.g., benzene for

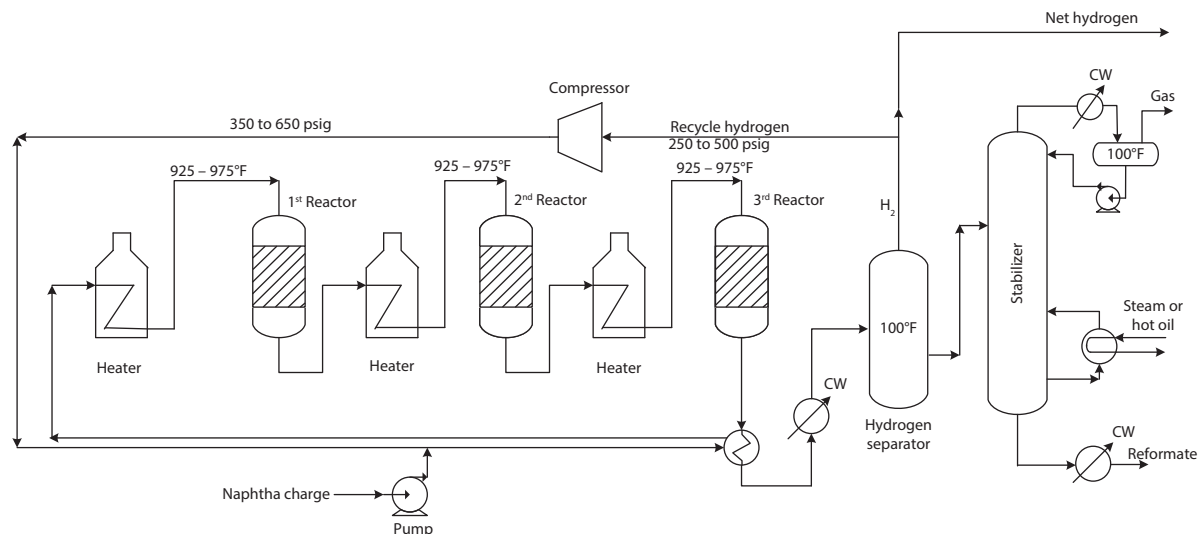


Figure 9.2 Catalytic reforming semi-regenerative process.

the petrochemical industry. A by-product of reforming is a high hydrogen content net gas stream that is used in hydrotreating and hydrocracking operations.

9.4.1 Role of Reformer in the Refinery

Refiners worldwide employ catalytic reforming to produce high-octane reformate for gasoline blending and high-value aromatics (benzene, toluene, and xylene, BTX) for petrochemicals use. Additionally, reforming is a major source of refinery-based hydrogen. Reforming operations continue to be challenged in

lowering gasoline pool and aromatic/benzene content; however, the catalytic reforming unit is still an essential part of refinery operations. The recently increased trend in hydrogen requirements has put even more emphasis on reformer hydrogen production. Figure 9.3 shows a process flow diagram of the reformer in a typical refinery unit. Here, the straight-run naphtha from the crude distillation unit is hydrotreated to remove sulfur, nitrogen, and oxygen, which can all deactivate the reforming catalyst. The hydrotreated naphtha (HTN) is fractionated into light naphtha (LN), which is mainly $C_5 - C_6$, and heavy naphtha (HN), which is

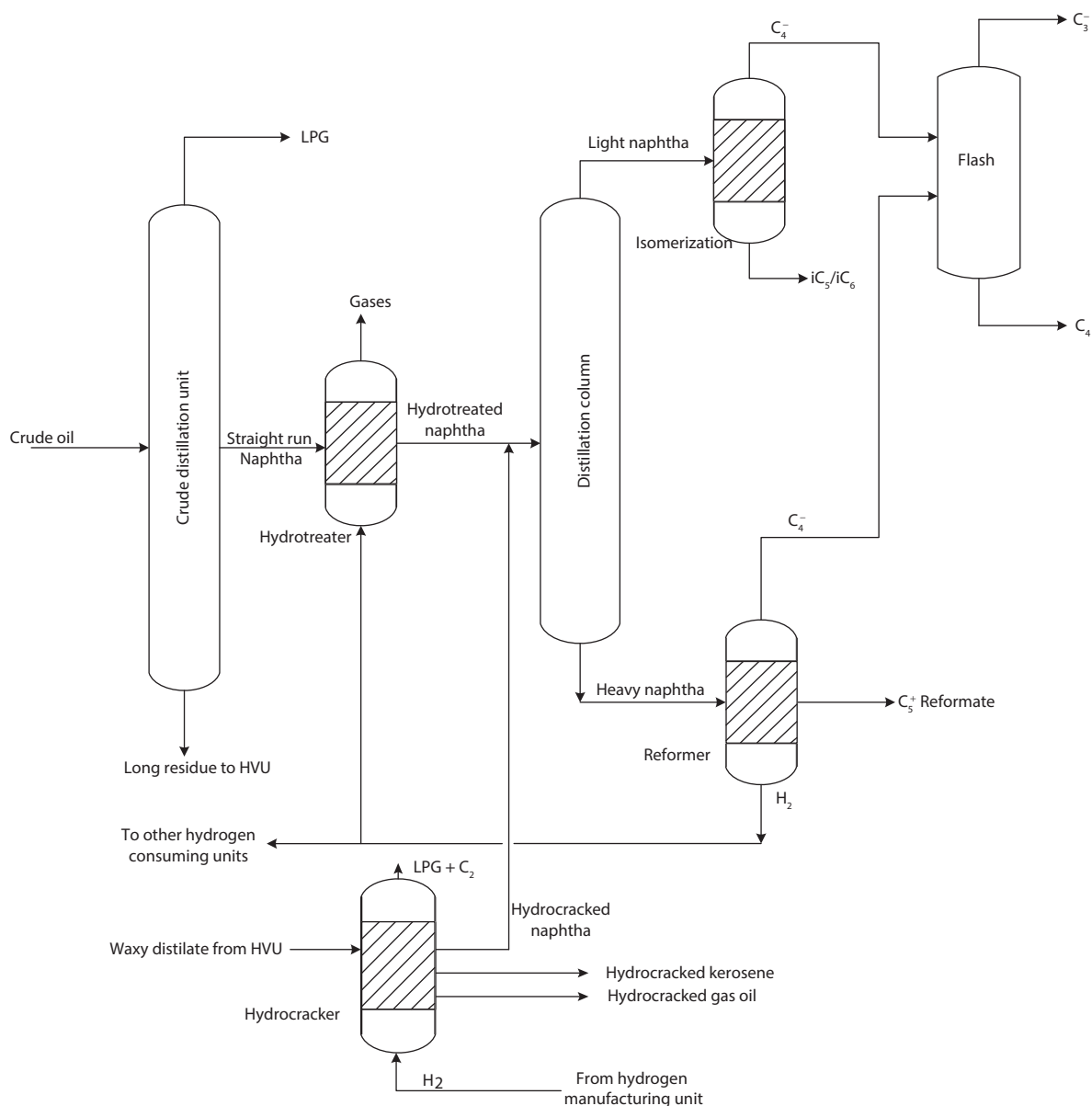


Figure 9.3 Process flow diagram of the reformer in the refinery facility.

mainly $C_7 - C_{10}$ hydrocarbons. C_6 is removed from the reformer feed as this could result in the formation of benzene, which is considered carcinogenic upon combustion. Light naphtha (LN) is isomerized in the isomerization unit. Light naphtha can be cracked if introduced to the reformer. The heavy naphtha (HN) is fed to the reformer, which is a fixed-bed reactor. A by-product of reforming is a relatively high hydrogen content net gas stream that is recycled to the naphtha hydrotreater operation and the rest is routed to another unit such as hydrocracking operation.

9.4.2 UOP Continuous Catalytic Regeneration (CCR) Reforming Process

The first UOP Continuous catalytic regeneration (CCR) reforming process unit was started up in 1971

and ushered in a new era for catalytic reforming. The continuous catalytic reforming process unit consists of either a stacked design in which the reactors are stacked on top of each other (Figure 9.4) or side by side. In both cases, the sequence of flow of the reactants is similar to that shown for the semi-regenerative system (Figure 9.2).

In CCR reforming, the reactants are introduced from the outside of the outer cylinder and flow radially through the catalyst to the center of the inner cylinder. The catalyst flows through the reactors (R1 - R4) in series instead of remaining static in fixed bed of individual reactors. Spent catalyst is continuously removed from the last reactor, transferred to the regeneration section where the carbon is burned from the catalyst, regenerated in a controlled environment and transferred back to the first reactor. The final

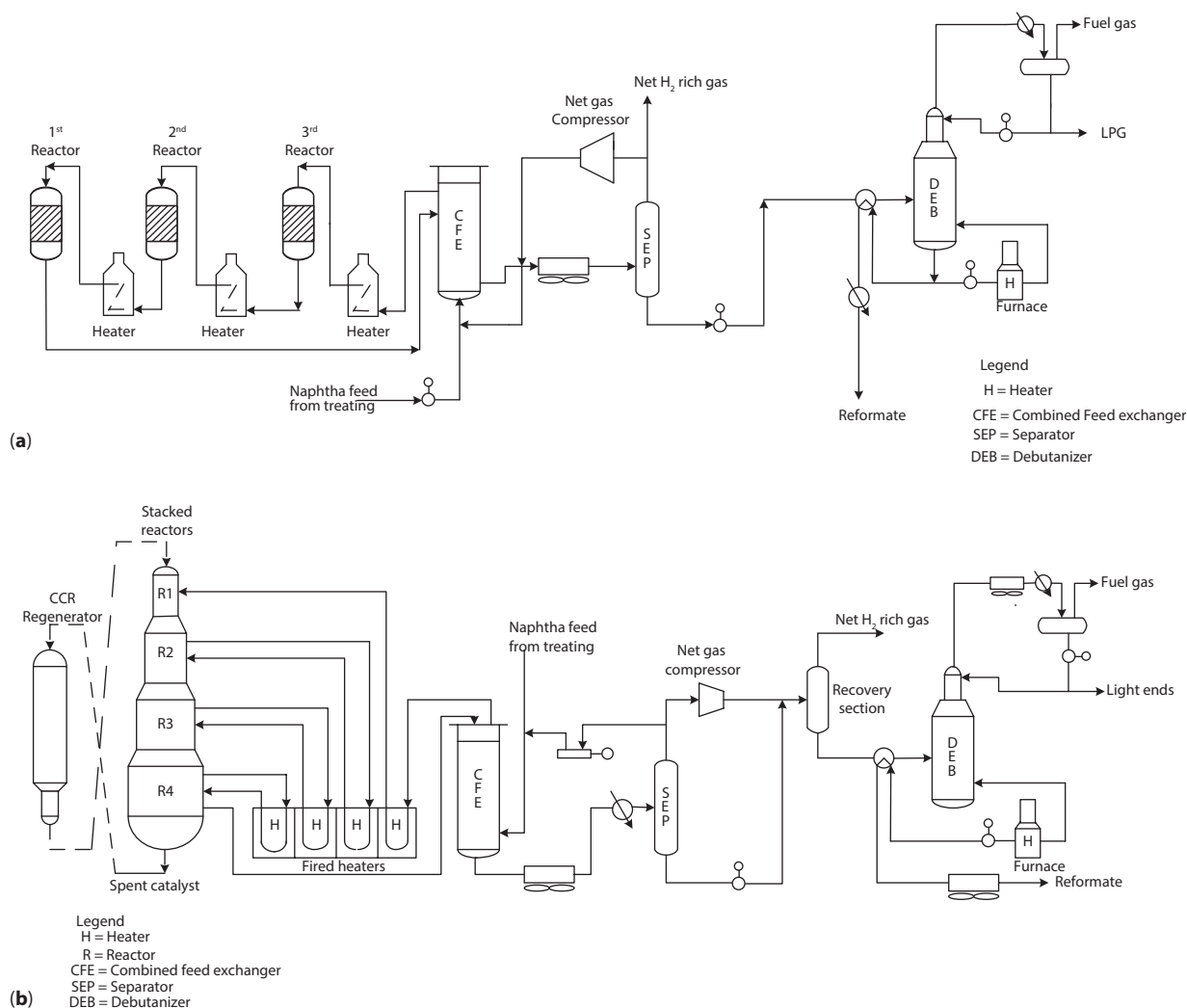


Figure 9.4 (a) Fixed-bed UOP Platforming process. (b) Continuous catalyst regeneration (CCR) reformer, UOP Platforming process.

product from R4 is sent to the stabilizer and gas recovery section.

The catalyst is reduced and acidified before being returned to the upper reactor. Since the catalyst is regenerated much more frequently in CCR reforming than in fixed-bed reforming, much higher severity operation is possible. In addition to making high-octane reformate for gasoline blending, many CCR reforming units are used to create feedstocks for aromatic complexes, since the reformate product contains a high concentration of $C_6 - C_{10}$ range aromatics. The CCR process is operated at lower hydrogen partial pressure ($p_{H_2} = 3$ bar) compared with the semi-generative process ($p_{H_2} = 35$ bar), with a reformate yield gain of nearly 10 vol%.

Modern CCR reforming units operate with pressures as low as 35 psig (2.4 barg), which allows for a high selectivity to desired products (C_{5+} reformate and hydrogen) and a minimal production of undesired products (methane, ethane, and LPG). Since the first CCR reforming unit was started in 1971 CCR reforming catalysts still contain platinum (Pt), which is required to catalyze important reforming reactions. The level of platinum required on the catalyst has been considerably reduced over time as feedstock containment levels and regeneration quality has improved. Rhenium (Re) is not used since CCR reforming catalysts do not need to be as stable as fixed-bed reforming catalysts. However, CCR reforming catalysts do use other metals; most notably tin (Sn) to enhance catalyst selectivity. While most CCR reforming catalysts are bimetallic (i.e., containing platinum and tin), other proprietary promoter metals are used in some catalysts,

with their objective being catalyst selectivity enhancement. UOP has licensed over 300 CCR reforming units worldwide with more than 250 of those being UOP CCR Platforming process units. Figures 9.4a and 9.4b show process flow diagrams of typical UOP fixed-bed and CCR Platforming process units, respectively.

Recent shifts in the demand for reformate that is used for gasoline blending and petrochemicals production and hydrogen have caused many reforming unit operators to adjust their operations considerably from their initial designs. This has caused many reforming units to be operated in a less efficient manner. Many reforming units that were designed decades ago are also more prone to reliability issues. Table 9.2 shows various types of reforming process technology from licensors. Table 9.3 provides a summary of performance and yield of the catalytic cracking reforming unit.

UOP basic CCR platforming has a single-stacked reactor. Stacked reactors offer many advantages which include lower capital cost, fewer pieces of equipment, lower catalyst attrition and easier maintenance. UOP has developed four types of CCR [29]:

1. Catalytic regenerators.
2. Atmospheric CCR regenerator
3. Pressurized CCR regenerator, Cycle Max™ CCR.
4. Sequential CCR regenerator.

The reactors use a proprietary up flow center pipe. In reducing both chloride consumption and treating costs

Table 9.2 Catalytic reforming processes [30].

Process name	Licensor	Reformer type
Catalytic reforming	Institut francais du petrole	Semiregenerative, continuous catalytic regenerative, hybrid semi regenerative, continuous catalyst regenerative
Magnaforming	Engelhard Industries, Div. of Englehard ARCO: Atlantic Richfield Co.	Semiregenerative, semicyclic
Platforming	UOP process	Semiregenerative, continuous catalyst regenerative hybrid
Cyclex™	UOP process	Fixed bed reforming
Powerforming	Exxon Research and Eng. Co.	Cyclic, semiregenerative, semicyclic
Rheniforming	Chevron Research Co.	Semiregenerative
Ultraforming	Standard Oil Co. (Indiana) Anoco R & D dept.	Cyclic, semiregenerative, semicyclic.
Houdriforming	Houdry Process Corporation	
Octanizing	Axen	CCR

in CCR platforming units, a system known as chlosorb that recovers chlorides (HCl and Cl₂) from vent gases and recycles the chlorides back into the process has been adopted. Operating condition and yield pattern of CCR are shown in Tables 9.4, 9.5 and 9.6, respectively.

9.5 Operations of the Reformer Process

Virgin naphtha from CDU is the primary feed to naphtha reformers. The naphtha feed boiling point range is suited to the desired reformat product. It is necessary to reduce the hydrocarbons with fewer than six carbon atoms (<C₆) in the feed as they tend to hydrocrack to light hydrocarbon gases and reduce the capacity of the unit for processing good reforming feedstocks. Therefore, the total light naphtha from crude oil fractionation is commonly split with only the heavier portion sent to the reformer.

The ASTM D 86 distillation for a gasoline operation is usually kept within the range 185–385 °F (85–196 °C). Owing to the severity of the reforming operating conditions, there is a rise in the ASTM D86 end point of 15–30 °F (8.3–16.7 °C) against the naphtha feedstock. Heavier stocks not only raise the end point of the reformat product, they also hydrocrack more readily and lower the catalyst activity by producing more coke. Therefore, it is necessary to allow for

Table 9.3 Typical performance and yield summary of continuous catalytic reforming unit [30].

	Average	Normalized yield
RONC	98.41	
Reformat	95.10	94.2
H ₂ rich gas	5.82	5.0
Hydrogen	2.48	2.40

Table 9.5 Typical yield pattern of continuous catalytic reforming unit [30].

	Quantity in 1000 tons	% wt
Feed: Hydrotreated naphtha	62.50	100.0
Product		
Reformat	58.8	
LPG	0.6	
Component	2.8	
Hydrogen	0.3	
Rich gases		
Gas and loss	62.5	
Total		100.0

Table 9.6 Typical characteristics of naphtha hydrotreater unit feed, reformer feed and reformat [30].

	Naphtha hydrotreater unit feed	Reformer feed	Reformat
Specific gravity	0.7613	0.7615	0.8109
IBP	84	87	43
5%	95.3	96.6	80.4
10%	97.6	98.6	89.8
40%	107	106.7	110.2
50%	110.7	110.4	115.8
70%	119.7	119	128.2
90%	133	132.2	147.8
95%	138.7	138.4	162
FBP	148.7	149.6	177.4
Sulfur (ppm)	210	0.9175	
RONC			98.41
RVP			0.462
PONA:			
P		48.9	25.75
O		0.2	0.0
N		26.02	11.91
A		24.84	62.34

Table 9.4 Catalytic reforming operating conditions for different reformers [30].

	Typical semiregenerative process with R – 62 catalyst	Full conversion to CCR platforming with R – 134 catalyst	State-of-the-art CCR platforming with R – 134 catalyst
Feed rate (m ³ /h)	99.40	139	139
Reactor pressure [kg/cm ² (psig)]	21.1 (300)	7.0 (100)	3.5 (50)
C ₅ ⁺ RONC	98	102	102
Catalyst cycle length (months)	12	Continuous operation	Continuous operation
C ₅ ⁺ yield (LV%)	74.2	78.8	80.0
H ₂ yield [(nm ³ /m ³) SCFB]	141 (835)	262 (1,552)	289 (1,709)

the end point rise when distilling reforming the stock from the crude oil. Generally, the higher the end point of the reforming naphtha, the higher the end point rise of the reformate and the greater the coke deposits on the catalyst. The feedstock material boiling higher than 400 °F (205 °C) tends to hydrocrack excessively in the reformer and is rendered unusable.

When a reformer unit is being employed to produce aromatics for the petrochemical industry, the end point of the naphtha is reduced and the process conditions are adjusted to selectively promoting the formation of aromatic compounds. More often, refiners may have one reformer dedicated to producing aromatics and the other in producing blending stock for motor gasoline.

The endothermic dehydrogenation reactions that predominate in the reformer result in significant temperature drops across the reactors. To keep the reaction rates high, inter-heaters (Figure 9.2) are used between the reactor beds to reheat the reactor effluent to the desired inlet temperature. The inter-heaters may be separate furnaces or separate coils within a large furnace. The temperature drops across the reaction beds progressively and decreases as exothermic reactions such as isomerization and hydrocracking start to occur after the first reaction bed. A semi-regenerative three-reactor process may have typical temperature drops of 90–130 °F (50–72 °C), 40–60 °F (22.2–33.3 °C) and 10–20 °F (5.6–11.1 °C) across the three reactor beds. The temperature drop across the last reactor is monitored to measure catalyst activity, as this reactor will have a small temperature drop when the catalyst

is fresh, but gradually increases as the catalyst deactivates and the exothermic hydrocracking reactions increase [18].

Usually, a refiner will operate the reformer with identical inlet temperatures to all reactors. Typical inlet temperatures for all reactors are in the range from 915–980 °F (491–527 °C) and these are dependent on the desired reformate octane number and/or aromatic content. As the temperature increases, the reformate octane number increases and the volume of the reformate product decreases. Furthermore, as the temperature increases, the yields of the light hydrocarbon liquids and gases increase as well as the coke deposited on the catalyst. Figure 9.5 shows the relationship between product yields and reformate octane number. As the reforming stock becomes less paraffinic (i.e., more naphthenic and aromatic), the reformate yields increase for a given octane number. In the naphtha reformer, over 98% of the naphthenes in the feed are converted to the corresponding aromatic compounds by dehydrogenation reactions, as the aromatic compounds pass through the reactor unchanged. The paraffins must first undergo cyclization reactions before they can be converted to the more stable aromatic compounds. These reactions are much slower than the dehydrogenation reactions and therefore, the paraffins are hydrocracked as well as cyclized. The hydrocracking of the paraffins produces light hydrocarbon liquids and gases and reduces the yield of reformate.

The pressure influences the reformate properties. The reformer pressure varies over a range of 100–500 psig (7.9–35.5 barg), depending on the desired

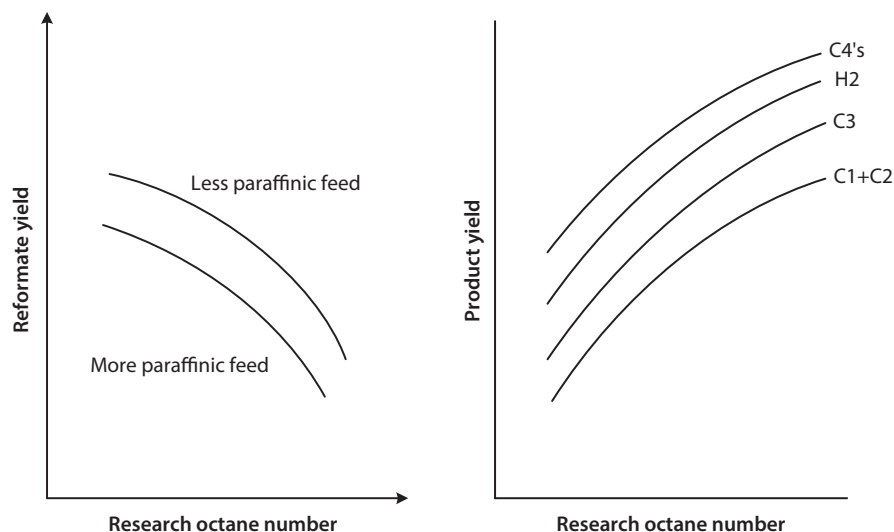


Figure 9.5 Typical reforming yield relationship.

product from the unit. Low pressures increase aromatic production since the dehydrogenation reactions are increased, while high pressures favor hydrocracking. Another control variable is the hydrogen to hydrocarbon mole ratio (H_2/HC) entering the reactors. For gasoline operation, a ratio from 3–5 moles hydrogen per mole hydrocarbon is commonly used. This parameter affects both the product distribution and the reduction in catalyst activity for semi-regenerative reforming processes. Generally, raising the hydrogen to the hydrocarbon ratio decreases the deposition of coke on the catalyst.

The naphtha charge to a reformer typically contains paraffins, naphthenes, and aromatics (no olefins) containing 5–11 carbon atoms. This usually limits the naphthene and aromatic content to one-ring structure. A gas/liquid chromatography instrument can be readily employed to determine this range of components, as the complete breakdown of reforming naphtha can be represented by about 50 major components. Although this results in a large number of reactions, kinetic models have been developed that represent major reactions in a reformer. Henningsen, *et al.* [9] have developed a typical model and Turpin [19] has published a guideline for constructing a predictive component-based model for naphtha reformers. Kinetic models for constructing and predicting naphtha reformers are reviewed later in the chapter.

9.5.1 Effect of Major Variables in Catalytic Reforming

The major variables in catalytic reforming process are feedstock, reaction temperature, space velocity, hydrogen to hydrocarbon ratio and catalyst type. Aromatic yield is increased by high temperature, low pressure and low hydrogen to hydrocarbon (H_2/HC) ratio.

Feed Quality

The feedstock properties greatly affect the reformate yield and aromatic content of the reformate. Naphthenes dehydrogenate very fast and therefore, high naphthenic feed gives highest reformate yield whereas feedstock with high paraffinic contents require more severe conditions and give lower reformate yields. Cyclization is faster for C_8 paraffin than for C_7 , and for C_7 than for C_6 . Most suitable fractions for catalytic reforming process is $C_7 - C_{10}$ fractions. General recommended feed ranges of temperatures for the production of benzene,

toluene, xylene and octane blending stock are 60–90 °C, 90–110 °C, 110–140 and 90–140 °C, respectively. $N + 2A$ is employed to measure the yield of the reformer; with higher $N + 2A$, the aromatic yield will be higher. The characterization factor is given by:

$$\text{Characterization factor} = 12.6 - \frac{N + 2A}{100}$$

Higher $N + 2A$ results in higher reformate yield and octane number. Although $N + 2A$ is commonly used to measure the feed quality, Institut francais du petrole (IFP) uses $0.85N + A$, which is found to be more representative. The higher is this index, the lower is the severity to meet the same product specification. Conversely, the lower the index, the higher the severity of operation to meet the same product specifications as the dehydrocyclization of paraffins becomes important [31].

Reactor Temperature

The reaction temperature is the most important variable in catalytic reforming since the product quality, and yields are highly dependent on it. WABT (weighted-average bed temperature) and WAIT (weighted-average inlet temperature) are the two main parameters to express reforming reactor average temperature. The difference between WABT and WAIT is that the former represents the integrated temperature along the catalyst bed, and the latter is calculated with the inlet temperature of each reactor.

All reaction rates are increased when operating at the high temperatures. Hydrocracking, which is not desirable in catalytic reforming, occurs to a greater extent at high temperatures. Furthermore, reaction temperatures affect the catalytic reforming reactions as catalyst activity is dependent on temperature. High temperature increases the undesirable reaction resulting in lower octane and yield. An increase in temperature favors the kinetics of dehydrogenation, isomerization, and dehydrocyclization. However, it favors undesirable reactions and results in higher coke formation. Therefore, a controlled temperature is required for high octane and longer catalyst life. The reformer reactor inlet temperature is maintained at around 878–1022 °F (470–550 °C). A temperature below 788 °F (420 °C) or above 1022 °F (550 °C) results in lower reformate yield. Therefore, to obtain high product quality and yields, it is necessary to control the hydrocracking and aromatization reactions, and reactor temperatures are

constantly monitored to observe the extent of each of these reactions.

Pressure

Pressure affects the catalytic reforming process as all the desirable reactions are favored by lower pressure. Although a decrease in pressure increases dehydrogenation of naphthenes and dehydrocyclization of paraffins, which results in higher production of aromatic and hydrogen. However, this increases the rate of coking of the catalyst, which results in its deactivation and a reduced cycle length. Furthermore, higher pressure causes higher rates of hydrocracking and reduces the reformat yield. This decreases coking of the catalyst and results in longer cycle life and a reduced reformat yield. Because of the pressure drop, the reactor pressure declines across the various reaction stages. The average pressure of the various reactors is generally referred to as the reactor pressure. An optimum pressure is required in balancing the yield of aromatic and the formation of coke. Typical reactor pressures are 200–500 psig [13.79–34.48 barg] (semi-regenerative and cyclic regeneration) and 60–150 psig [4.14–10.34 barg] (continuous regeneration).

Hydrogen-to-Hydrocarbon (H_2/HC) Ratio

The H_2/HC ratio is stated on a molar basis [i.e., moles of hydrogen in the recycle gas (a mixture of hydrogen and light gases) per mole of naphtha feed (mol/mol)]. Values of 4 to 6 mol/mol are typical in commercial reforming units. The molar ratio of hydrogen and hydrocarbon has a direct impact on the formation of coke. Hydrogen partial pressure is related to the $H_2/$

HC ratio and total pressure. An increase in the partial pressure of hydrogen results in an increase in the hydrogenation of the coke precursors prior to their transformation into aromatic polycyclic hydrocarbons [32]. The higher the H_2/HC ratio, the greater the cycle length. The recycle of hydrogen is necessary for the operation for catalyst stability. An increase in H_2/HC ratio will move the hydrocarbon at a faster rate in the reactor and supply greater heat sink increased stability. Table 9.7 shows the effect of temperature, pressure and H_2/HC ratio in the reforming process.

Space Velocity

Both liquid hourly space velocity (LHSV) and weight hourly space velocity (WHSV) are typically used in catalytic reforming units to express space velocity. Space velocity and reactor temperature are commonly used to set the octane of a product. The greater the space velocity, the higher the temperature required to produce a given product octane. The severity of the catalytic reforming unit can be increased either by increasing the reactor temperature or by reducing the space velocity.

Space velocity directly affects the kinetics of reforming reactions and has a direct impact on the octane rating. A lower space velocity results in an increase in the octane number. Highly naphthenic feedstock requires high space velocity whereas more paraffinic stocks require lower space velocities. A decrease in space velocity means an increased residence time; therefore, a higher severity, resulting in an increased octane number, lower reformat yield, and higher coke deposit. Space velocity is defined on the liquid hourly basis or weight hourly basis.

Table 9.7 Effect of temperature, pressure and H_2/HC ratio [30].

Increase of	Effect on dehydrogenation due to thermodynamics to kinetics		Effect on dehydrocyclization due to thermodynamics to kinetics	
Temperature	Increases	Increases	Decreases	Decreases
Pressure	Decreases	Unaffected	Increases	Increases
H_2/HC ratio	Slightly decreases	Slightly decreases	Slightly decreases	Slightly decreases

Increased	RONC	Reformat yield	H_2 yield	Coke deposit
Pressure	Decrease	Decrease	Decrease	Decrease
Temperature	Increase	Decrease	Increase	Increase
Space velocity	Decrease	Increase	Decrease	Decrease
0.85N + A	Increase	Increase	Increase	Decrease

Liquid hourly space velocity (LHSV) is:

$$LHSV = \frac{\text{Hourly feed flow rate, m}^3/\text{hat } 15^\circ\text{C}}{\text{Volume of catalyst in m}^3}$$

Weight hourly space velocity is:

$$WHSV = \frac{\text{Weight of feed per hour}}{\text{Weight of catalyst}}$$

Chloride Influence on Reforming Reactions

A careful balance must be maintained between the hydrogenation/dehydrogenation function of platinum (Pt) and the acid function of alumina in the bifunctional catalyst. Moisture in the naphtha and chlorine in the catalyst are the two main parameters that control the acidity of the catalyst. The water and chlorine balance should be continuously monitored such that the water content in the feed should be about 3–6 ppm. The water that is formed by combustion strips the chloride from the catalyst and thus chlorine is added to maintain the required level as well as to keep the platinum dispersed [33].

9.6 Catalytic Reformer Reactors

Various types of reactors are currently in operation, and these include semi-regenerative, cyclic and continuous catalyst regeneration. In all the cases, the regeneration of the catalyst involves heating to burn off the coke, which is followed by chemical treating. The catalyst is replaced after certain period of time for semi-regenerative and cyclic operations, while continuous catalytic reaction resembles FCC, where a purge stream of the catalyst is withdrawn, and fresh catalyst is added after a turnaround and before startup of the operation.

The semi-regenerative process is a single reactor that processes the feedstock. As the reactor processes the feed, the catalyst starts to lose its activity; at some point around the middle of the catalyst life cycle, the reactor is taken offline, and the catalyst is regenerated. The advantages to this process are the low capital investment and simple process flow. However, the regeneration cycle may be too long to maintain the desired levels of production that depend on the refiner's feed type.

Cycle processes involve a series of beds that operate on a rotating basis. There is a set of 5–6 reactors,

although only 3–4 may be in operation at a given time. When the catalyst activity for a given reactor falls below a certain value, that reactor is taken offline, and the feed flow is shunted to a reactor with recently regenerated catalyst [3].

Moving-bed or continuous catalyst regeneration (CCR) involves the continuous regeneration of the catalyst. This is possible through the construction of a special reactor that allows the continuous withdrawal of catalyst while the reactor is on-stream. The withdrawn catalyst enters a regeneration section.

Specific details of the various reforming reactor types are proprietary and furthermore, it is not essential to have these details when building steady-state models with commercial simulators programs. We have discussed the various reactions that occur in catalytic reformers. Petroleum pseudo-components are not adequate to the development of such models and an actual component breakdown of the major components in the feed and reformate product is required. Figure 9.6 shows these reactor types for these processes; Table 9.8 gives a comparison with the operating conditions for the three reforming processes. Yield advantage and operating condition of catalytic cracking reformer over semi-regenerative fixed bed are shown in Tables 9.9 and 9.10 respectively.

A commercial semi-regenerative reforming unit has four reactors with interstage heaters and operates at the following reaction conditions: The inlet temperature is 858.2 °F (459 °C), reactor pressure is 10.5 kg/cm², H₂/HC ratio is 6.3 mol/mol, and feedstock flow rate is 30,000 bbl/day. The hydrodesulfurized straight-run naphtha used as a feedstock has the following main properties: 0.7406 specific gravity, 60/60 °F, 104.8 g/mol molecular weight, 190.4–356 °F (88–180 °C) distillation range, 59.11 mol% total paraffins, 20.01 mol% total naphthenes, and 20.88 mol% total aromatics [34].

The main characteristics of each of the four reactors of a semi-regenerative reforming unit are shown in Table 9.11. The inverse of weight hourly space velocity (100/WHSV) is reported in this table since this parameter is used more commonly to indicate the increased reaction severity and reactant reactor positions. The table shows that the first reactor is always smaller than the other reactors, and the last reactor is the largest. This difference in reactor size is because the reactions occurring in the first reactors are very fast and those taking place in the last reactors are slow.

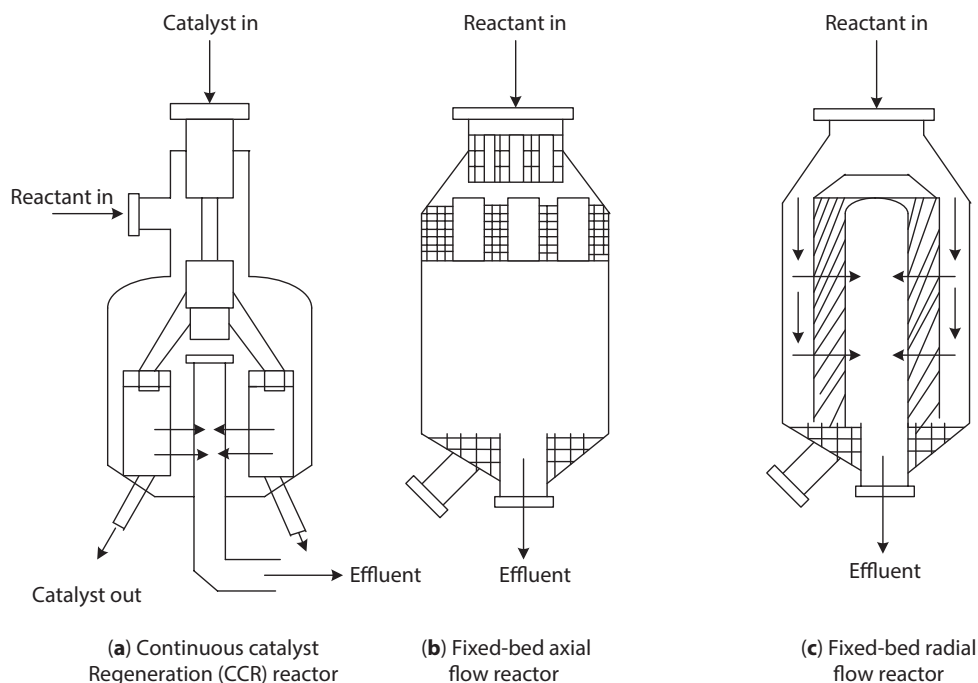


Figure 9.6 Reactor types used in reforming processes.

Table 9.8 Typical operating conditions of three reforming processes (Martino, 2001).

Reforming process	Catalyst	P (bar)	H ₂ /HC mol/mol	Space velocity (h ⁻¹)	RON
Semi-regenerative fixed bed	Monometallic	> 25	> 25	1-2	90-92
	Bimetallic	12-20	4-6	2-2.5	81-89
Cyclic bed	Bimetallic	15-20	4	2	96 - 98
Continuous moving bed	Bimetallic	3-10	2	2-3	100-102 >104 for aromatic production

Table 9.9 Comparison of conventional and octanizing process.

Yields: Typical for a 176 °F-338 °F (90 °C-170 °C) cut from light Arabian feedstock [*Hydrocarbon Process*, p 61, Nov. 1998].

	Conventional	Octanizing
Operating pressure (kg _f /cm ²)	10-15	< 5
Yields (% wt on feed)		
Hydrogen	2.8	3.8
C ₅ ⁺	83	88
RONC	100	102
MONC	89	90.5

Installation: Over 100 units licensed, 53 units are designed with continuous regeneration technology capability.

Licensors: IFP

9.7 Material Balance in Reforming

Catalytic reforming data have been compiled by Maples [27] and these were correlated by Fahim *et al.*

[11]. The yield correlations for the reformer are shown in Table 9.12. Tables 9.13 and 9.14 show the analyses of the feeds for naphthenes and paraffins and their corresponding conversions.

Table 9.10 Typical condition and yield pattern in semi-regenerative and continuous catalytic reforming. [Source: *Hydrocarbon Processing*, p 61, Nov. 1998].

Yields

Operating mode	Semi-regenerative	Continuous
On stream availability (days/year)	330	360
Feedstock	Middle East	Middle East
IBP/EP (°F)	200/380	200/380
Operating conditions		
Reactor pressure (psig)	200	50
C ₅ ⁺ octane, RONC	100	100
Catalyst	R – 72 staged loading	R – 134
Yields information		
Hydrogen (scfd)	1,290	1,640
C ₅ ⁺ (Iv%)	77.5	82.8

Licensor: UOP LLC

Table 9.11 Main characteristics of the commercial catalytic reforming reactors [34].

	Reactor				
	1	2	3	4	Total
Length (m)	4.902	5.410	6.452	8.208	24.972
% of reactor length	19.6	21.7	25.8	32.9	100.0
Accumulated% of reactor length	19.6	41.3	67.1	100.0	
Diameter (m)	2.438	2.819	2.971	3.505	
Catalyst weight (tons)	9.13	13.82	22.82	42.58	88.35
wt% of catalyst bed	10.3	15.7	25.8	48.2	100
Accumulated wt% of catalyst bed	10.3	26.0	51.8	100	
WHSV (h ⁻¹)	16.0	10.6	6.4	3.4	36.4
Accumulated WHSV (h ⁻¹)	16.0	26.6	33	36.4	
100/WHSV	6.25	9.43	15.63	29.41	60.72
Accumulated 100/WHSV	6.25	15.68	31.31	60.72	

Example 9-1

100 m³/h of heavy naphtha (HN) with specific gravity of 0.78 has the following composition: A = 12 vol%, N = 22 vol% and P = 67 vol% is to be reformed to naphtha reformat of RON = 95. Calculate the yields of each product for that reformer.

Solution

Given $RON_R = 95$, $N+2A = [22 + 2(12)] = 46$ with specific gravity of 0.78. The following reformer yield:

$$\begin{aligned}
 C_5^+ \text{ vol\%} &= 142.7914 - 0.77033 \times RON_R + 0.219122 \times (N+2A)_F \\
 &= 142.7914 - (0.77033 \times 95) + (0.219122 \times 46) \\
 &= 79.69 \% \qquad (9.10)
 \end{aligned}$$

The yields for the other products are calculated from the correlations in Table 9.12. The material balance for the reformer is shown in Table 9.15.

Example 9-2

Heavy naphtha has the following detailed analysis in mol% is fed to a reformer unit.

Cyclohexane (C ₆ H ₁₂)	20
Heptane (C ₇ H ₁₆)	40
Dimethylcyclohexane (C ₈ H ₁₆)	30
1,2,3,4 Tetramethyl benzene (C ₁₀ H ₁₄)	10

Calculate the composition of the products.

Table 9.12 Reformer correlations [11].

$H_2 \text{ wt\%} = -12.1641 + 0.06134 \times C_5^+ \text{ vol\%} + 0.099482 \times RON_R$	(9.1)
$C_1 \text{ wt\%} = 11.509 - 0.125 \times C_5^+ \text{ vol\%}$	(9.2)
$C_2 \text{ wt\%} = 16.496 - 0.1758 \times C_5^+ \text{ vol\%}$	(9.3)
$C_3 \text{ wt\%} = 24.209 - 0.2565 \times C_5^+ \text{ vol\%}$	(9.4)
$\text{Total } C_4 \text{ wt\%} = 27.024 - 0.2837 \times C_5^+ \text{ vol\%}$	(9.5)
$nC_4 \text{ wt\%} = 0.585 \times \text{total } C_4 \text{ vol\%}$	(9.6)
$iC_4 \text{ wt\%} = 0.415 \times \text{total } C_4 \text{ vol\%}$	(9.7)
$C_5^+ \text{ vol\%} = -0.03806 \times RON_R^2 + 6.292793 \times RON_R - 14.4337 \times K_w$	(9.8)
$C_5^+ \text{ vol\%} = 132.2483 + 0.66472 \times RON_R + 0.297921 \times RON_F$	(9.9)
$C_5^+ \text{ vol\%} = 142.7914 - 0.77033 \times RON_R + 0.219122 \times (N + 2A)_F$	(9.10)
$SCFBH_2 = 0.0002 + 0.48848 H_2 \text{ wt\%}$	(9.11)

RON_F = research octane number of feed; RON_R = research octane number of reformat, $C_5^+ \text{ vol\%}$ = volume percent of reformat yield; $SCFBH_2$ = standard cubic foot of H_2 produced/barrel of feed; K_w = characterization factor; $T_B^{1/3}/SpGr$; TB = absolute mid - boiling point of feed, °R; SpGr = specific gravity of feed; N = naphthenes vol% and A = aromatics vol%.

Table 9.13 Naphthenes conversion to aromatics by dehydrogenation (Gary and Handwerk, [28]).

Feed (naphthenes)	Conversion	Products (aromatics)
Methylcyclohexane (MCC_6)	0.98	Toluene
Cyclohexane (CC_6)	0.98	Benzene
Dimethylcyclopentane ($DMCC_5$)	0.98	Toluene
Dimethylcyclohexane ($DMCC_6$)	0.98	Xylene
Cycloheptane (CC_7)	0.98	Toluene
Methylcycloheptane (MCC_7)	0.98	Xylene

Table 9.14 Paraffin conversion to aromatics by dehydrocyclization (Gary and Handwerk [28]).

Feed (Paraffins)	Conversion	Products (aromatics)
Hexane	0.05	Benzene
Heptane	0.10	Toluene
Octane	0.25	Xylene
Nonane	0.45	1,3,4 - Trimethylbenzene (TMB)
Decane	0.45	1,2,3,4 Tetramethyl benzene

Table 9.15 Material balance from the correlation in Table 9.12.

	vol%	Volume (m ³ /h)	Density (kg/m ³)	wt%	Yield (kg/h)
Feed HN	100	100	780	100	78,000
Products					
H ₂ wt%				2.175	1697
C ₁ wt%				1.548	1207
C ₂ wt%				2.486	1939
C ₃ wt%				3.769	2940
Total C ₄ wt%				4.416	3444
nC ₄ wt%				2.583	
iC ₄ wt%				1.833	
C ₅ ⁺ vol%	79.69	79.69		(85.606)	(66,773)

Values in brackets are calculated by the material balance between the feed and the products.

Solution

Tables 9.13 and 9.14 are used to estimate the composition of the products as follows:

Assuming 100 mols of feed

Naphthenes

20 mol of cyclohexane (C₆H₁₂) gives $0.98 \times 20 = 19.6$ mol of Benzene

30 mol of dimethylcyclohexane (C₈H₁₆) gives $0.98 \times 30 = 29.4$ mol of Xylene

Paraffins

40 mol of heptane (C₇H₁₆) gives $0.10 \times 40 = 4$ mol of Toluene

Aromatics

1,2,3,4 Tetramethyl benzene is a product = 10 mol.

Final composition (mol%)

Cyclohexane	Heptane	DMCC6	Benzene
C ₆ H ₁₂	C ₇ H ₁₄	C ₈ H ₁₆	C ₆ H ₆
0.4%	36.0%	0.6%	19.6%
Toluene	Xylene	1,2,3,4 TMB	
C ₇ H ₈	C ₈ H ₁₀	C ₁₀ H ₁₄	
4.0%	29.4%	10%	

9.8 Reactions

Chemical reactions that occur in the reformer produce undesirable in addition to the desired. Thus, reaction

conditions should be chosen that favor the desired product and inhibit the undesired ones. The desired reactions in a catalytic reformer result in the formation of aromatics and isoparaffins are as follows [1]:

1. Paraffins are isomerized and to some extent converted to naphthenes. The naphthenes are subsequently converted to aromatics.
2. Olefins are saturated to form paraffins, which then react as in (1).
3. Naphthenes are converted to aromatics.
4. Aromatics are left essentially unchanged.

Reactions that result in the formation of undesirable products are:

1. Dealkylation of side chains on naphthenes and aromatics to form butane and lighter paraffins.
2. Cracking of paraffins and naphthenes to form butane and lighter paraffins.

There are four major reactions that occur during reforming process, and these are:

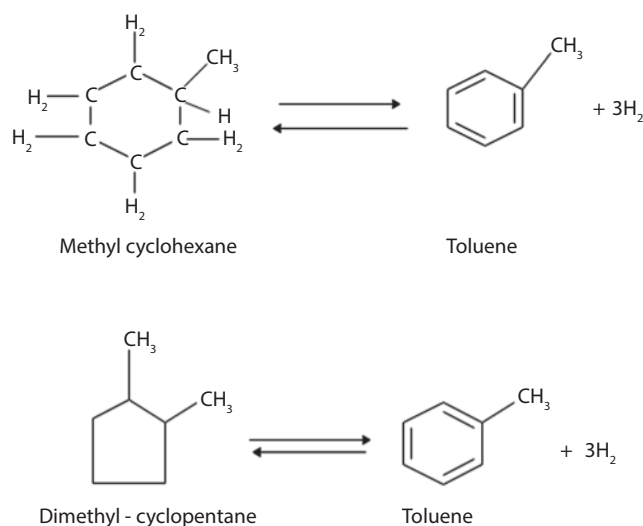
1. Dehydrogenation of naphthenes to aromatics.
2. Dehydrocyclization of paraffins to aromatics.
3. Isomerization
4. Hydrocracking.

9.8.1 Naphthene Dehydrogenation to Cyclohexanes

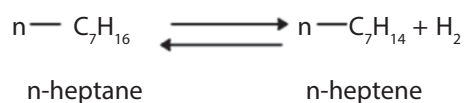
Naphthenes are present in reforming feeds in the form of cyclopentane (C₅H₁₀) and cyclohexanes (C₆H₁₂).

Cyclohexanes are dehydrogenated to give aromatics, while cyclopentanes are first hydroisomerized to produce cyclohexanes, which are further dehydrogenated to aromatics. The dehydrogenation of naphthenes to aromatics is probably the most important reaction of catalytic reforming.

The dehydrogenation reactions are highly endothermic and cause a decrease in temperature as the reaction progresses. The dehydrogenation reactions have the highest reactions rates of the reforming reactions, which require the use of the inter-heaters between catalyst beds to keep the mixture at high temperatures for the reactions to proceed (Figure 9.5).

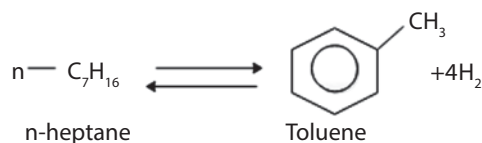


Paraffin Dehydrogenation

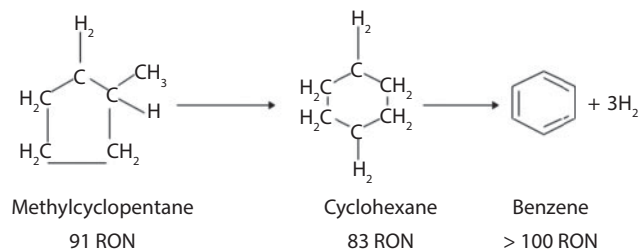


9.8.2 Dehydrocyclization of Paraffins to Aromatics

Paraffins undergo dehydrocyclization to produce cycloparaffins. The dehydrocyclization reaction involves dehydrogenation and aromatization steps and produces hydrogen.



9.8.3 Dehydroisomerization of Alkylcyclopentanes to Aromatics



All the above reactions are highly endothermic; however, the dehydrogenation of cyclohexane is a much faster reaction than either the dehydroisomerization of alkylcyclopentanes or the dehydrocyclization of paraffins. All reactions take place simultaneously and are necessary to obtain the aromatic concentration needed in the reformate product to yield the octane improvement required. The yield of aromatics increases by:

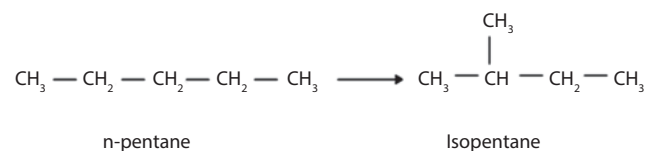
1. High temperature (increases reaction rate could adversely affect the chemical equilibrium).
2. Low pressure (shifts chemical equilibrium to the right).
3. Low space velocity (promotes an approach to equilibrium).
4. Low hydrogen-to-hydrocarbon mole ratios (shifts chemical equilibrium to the right. However, the hydrogen partial pressure must be maintained to avoid excessive coke formation).

9.8.4 Isomerization of n-Paraffins

Paraffins are isomerized to form branched-chain molecules (isoparaffins). Isomerization reactions are so fast that actual concentrations are near equilibrium. Isomerization of n-paraffins is a fairly rapid reaction with small heat effects. High H₂/HC ratios reduce the hydrocarbon partial pressure and thus favor the formation of isomers. The isomerization of n-paraffins does not consume or produce hydrogen.

Isomerization of paraffins and cyclopentanes results in a lower octane product than the conversion to aromatics. They are rapid reactions with small heat effects.

Isomerization of normal paraffins to isoparaffins:



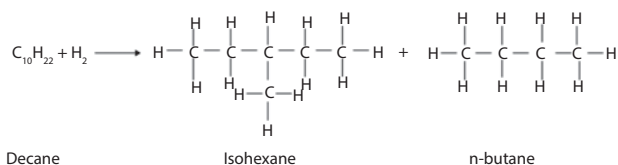
Isomerization yield is increased by:

1. The high temperature that increases the reaction rate.
2. Low space velocity, which increases reaction time.
3. Low pressure.

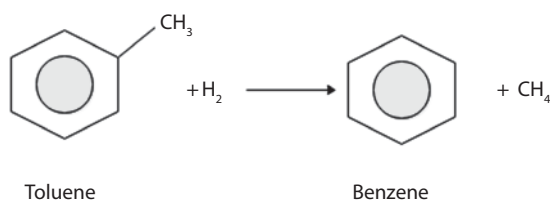
9.9 Hydrocracking Reactions

Paraffins are hydrocracked to form smaller molecules. This reaction is the only one that consumes hydrogen. The hydrocracking reactions are highly exothermic and consume high amounts of hydrogen resulting in the production of lighter liquid and gas products. The reactions are the main sources of C_4^- hydrocarbons (C_1 , C_2 , C_3 and C_4). The cracking results in the loss of the reformate yield. Since the reaction is relatively slow, most of the hydrocracking occurs in the final part of the reaction system. The major hydrocracking reactions involve the cracking and saturation of paraffins:

Paraffin Hydrocracking



Hydrocracking of Aromatics



The concentration of paraffins in the charge stock determines the extent of the hydrocracking reaction. However, the relative fraction of isomers produced in any molecular weight group is independent of the charge stock. Hydrocracking yields are increased by:

1. High temperature.
2. High pressure.
3. Low space velocity.

High product quality and yields are obtained by controlling the hydrocracking and aromatization

reactions. Reactor temperatures are monitored to observe the extent of each of these reactions. Low-pressure reforming is used for aromatics production.

9.10 Reforming Catalyst

The catalyst in the unit is the most important consideration for optimal operation. Little [3] identifies three key characteristics of reforming catalysts: activity, selectivity, and stability. The activity is a measure of how efficiently the catalyst can help convert the reactants into products. In general, current reforming catalysts can operate at higher temperatures and maintain high reaction conversion when the reactant flow rate increases. The selectivity refers to the catalyst ability to produce more of the high-value products (aromatics) than low-value products. The stability refers to the ability of the catalyst to maintain high activity and selectivity over long periods of time. The catalyst in reforming units is only changed once every 1–2 years [20].

Modern reforming catalysts consist of an alumina-based that supports platinum (Pt) and rhenium (Re) particles to catalyze the desired reactions. Platinum sites promote the dehydrogenation reactions and the alumina acting as an acid site promotes cyclization, isomerization and hydrocyclization [20, 21, 22, and 23]. These catalyst types are known as bimetallic (and sometimes bifunctional catalysts). As the catalyst spends more time on stream, coke deposits and lack of acid sites prevent an additional reaction. The rate of coke deposition is a function of olefin-like precursors that lead to the formation of a multi-aromatic ring [24].

Platinum (Pt) catalyst serves as a catalytic site for hydrogenation and dehydrogenation reactions and chlorinated alumina provides an acid site for isomerization, cyclization and hydrocracking reactions [25]. Reforming catalyst activity is a function of surface area, pore volume, and active platinum and chlorine content. Catalyst activity is reduced during operation by coke deposition and chloride loss. The activity of the catalyst can be restored by high-temperature oxidation of the carbon followed by chlorination.

Platinum on silica-based is commonly used for reforming catalyst. It is deactivated by hydrogen sulfide (H_2S), sulfur compounds, nitrogen (N_2) and oxygen (O_2). Thus the feed to a naphtha reformer is first hydrotreated in a desulfurizing reactor which has chrome-molybdenum catalyst. After hydrotreating, the naphtha is stripped with reformer hydrogen to remove hydrogen sulfide (H_2S). Kugelman [2] studied the

reaction equilibrium of C_6 through C_9 hydrocarbons and found that all types of reactions in the reformer are equilibrium limited except for the hydrocracking reactions. The dehydrogenation reactions occur very rapidly, followed by the isomerization reactions which are also rapid. The cyclization reactions and hydrocracking reactions take place much more slowly and thus account for the decreasing temperature drops across the reactors.

The newest CCR catalyst is high-density UOP's R-264 Platforming catalyst that allows continuous regeneration units to increase throughput and/or yields while reducing coke production. The R-264 as compared to R-130 series consists of a higher-density alumina support with a tailored pore structure and optimized metal/acid balance. These properties result in enhanced yield activity performance with approximately 20% less coke made. The catalyst can be operated in either a high activity mode to process more feed or achieve higher octane, or in a high-yield mode to achieve higher yields. Furthermore, the tailored pore structure minimizes very small pores, which allows for faster coke burning rates in the regenerator.

The R-264 has the ability to debottleneck units that are pinning constrained. Catalyst pinning is the condition where the force from the horizontal flow of feed across the downflowing catalyst results in the catalyst being held up against the center pipe screen. Pinning should be avoided as it impairs the reactant flow distribution, resulting in lower conversion and significantly higher coke production. The physical properties of the catalyst reduce pinning, allowing a higher feed throughput. Thus, the hydraulic capacity in many CCR Platforming units can be increased by ~10–20%, depending on whether the hydrogen-to-hydrocarbon (H_2/HC) ratio or recycle gas flow remains constant. The increased product volume from a higher feed rate results in significant increases in profitability.

The catalyst has high chloride retention and high surface area stability compared to other commercially available CCR Platforming catalysts. The R-264 catalyst properties allow it to be a drop-in replacement catalyst for the most existing continuous regeneration reforming units. It has the ability to maximize yields as it is preferred for almost all new CCR Platforming units for both motor fuel and aromatics applications. The high-density catalyst formulation facilitates smaller-sized reactors and small regenerators, resulting in lower equipment costs, and project net present values. It offers an economical means of obtaining additional capacity without capital expenditure [26]. Commercial experience of R-264 catalyst shows an increase of C_5^+ (1–2%) increased hydrogen production, decreased chloride injection by 70%, reduced coke and can operate in high activity or high-yield mode.

R-500 fixed-bed platforming catalyst was introduced by UOP in 2010. It has a very high catalyst activity and lowers start of run reactor temperatures. Major reactions involved in catalytic reforming process are dehydrogenation of naphthenes, isomerization of naphthenes and paraffins, dehydrocyclization of paraffins and hydrocracking of paraffins. Table 9.16 shows the effect of catalytic function on these reactions.

Gary *et al.* [1] reported the following conversion data for low-pressure reformers producing aromatics from 155–345 °F (68.7–174.2 °C) TBP naphtha.

- a. 98% of the feed naphthenes are converted to aromatics
 - Methyl cyclopentane (MCP) and cyclohexane make benzene
 - Dimethylcyclopentane and cyclohexane form toluene
 - Dimethylcyclohexane and methylcycloheptane produce xylene
- b. Paraffins yield the following quantities of aromatics:

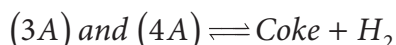
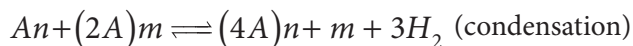
Table 9.16 Various reactions and effect of catalyst function [30].

Reaction	Catalyst function	Promoted by	
Naphthene dehydrogenation	Metal	Temperature	Pressure
Naphthene isomerization	Acid	High	Low
Paraffin isomerization	Acid	Low	-
Paraffin dehydrocyclization	Metal / acid	Low	-
Hydrocracking	Acid	High	Low
Aromatic dealkylation	Metal / acid	High	High
Demethylation	Metal	High	High

One mole of P6 produces 0.05 mole of benzene
 One mole of P7 yields 0.10 mole of toluene
 One mole of P8 produces 0.25 mole of xylene
 One mole of P9 gives 0.45 mole of A9
 One mole of P10 yields 0.45 mole of A10

9.11 Coke Deposition

Coke is deposited during hydrocracking resulting in the deactivation of the catalyst. The catalyst is reactivated by burning off the deposited coke. Coke formation is favored at low partial pressures of hydrogen. Hydrocracking is controlled by operating the reaction at a low-pressure range between 74–368 psia (5.1–25 bara) as lower pressure can lead to coke deposition and too high can result in cracking and loss of reformate yield. The coking reactions are:



where the hydrocarbon class and notation are:

Hydrocarbon Class	Notation
Paraffins (alkane)	P
Olefin (alkene)	O
1 Ring Naphthene (cycloparaffin)	N
Cyclo-olefin	CO
1 Ring Aromatic	A
2 Ring Naphthene	2N
2 Ring Aromatic	2A
3 Ring Naphthene	3N
3 Ring Aromatic	3A
4 Ring Naphthene	4N
4 Ring Aromatic	4A

Example 9-3

The following feed of 100 kg mol/h of naphtha is fed to a reformer unit.

Compound	C ₆ H ₁₄	C ₇ H ₁₆	C ₈ H ₁₈	C ₉ H ₂₀
mol% feed	25	25	25	25
a	-32.6 × 10 ³	-31.24 × 10 ³	-29.7 × 10 ³	-28.94 × 10 ³
b	51.2	53.4	53.4	53.8

$$\ln K_{eq} = \frac{a}{T} + b$$

K_{eq} is the equilibrium constant and T in K
 The constants a and b are shown in the table above.

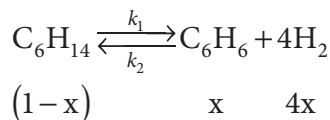
The main reactions in the reformer are the conversion of the paraffins to the corresponding aromatics, and are as follows:



Calculate the composition of reformate produced at 550 °C and 20 bar pressure.

Solution

Reaction 1



The rate of reaction of C₆H₁₄ is:

$$(-r_{C_6H_{14}})_{net} = k_1 C_{C_6H_{14}} - k_2 C_{C_6H_6} C_{H_2}^4$$

The net rate $(-r_{C_6H_{14}})_{net} = 0$

$$\text{The equilibrium constant } K_{eq} = \frac{k_1}{k_2} = \frac{C_{C_6H_6} C_{H_2}^4}{C_{C_6H_{14}}}$$

$$= \frac{p_{C_6H_6} p_{H_2}^4}{p_{C_6H_{14}}}$$

The partial pressure, $p = y\pi$, y = mole fraction and π = total pressure.

$$K_{eq} = \frac{k_1}{k_2} = \frac{p_{C_6H_6} p_{H_2}^4}{p_{C_6H_{14}}} = \frac{(y_{C_6H_6} \cdot \pi)(y_{H_2} \cdot \pi)^4}{(y_{C_6H_{14}} \cdot \pi)}$$

Stoichiometry	C ₆ H ₁₄	C ₆ H ₆	H ₂
t = 0	1-x	x	4x
t = t, total	1 + 4x	1 + 4x	1 + 4x
Mole fraction	(1-x)/(1+4x)	x/(1+4x)	4x/(1+4x)

where x reaction conversion

The equilibrium constant K_{eq} is:

$$\ln K_{eq} = \frac{a}{T} + b$$

$$K_{eq} = \exp(a/T + b)$$

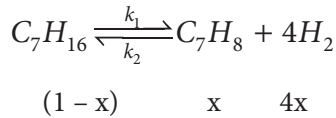
$$= \exp(-32.6 \times 10^3 / (500 + 273.15) + 51.17)$$

$$= 8390.3$$

$$K_{eq} = \frac{(y_{C_6H_6} \pi)(y_{H_2} \pi)^4}{(y_{C_6H_{14}} \pi)} = \frac{\left(\frac{x}{1+4x}\right) \pi \left(\frac{4x}{1+4x}\right)^4 \pi^4}{\left(\frac{1-x}{1+4x}\right) \pi}$$

Using the Go Seek in Excel spreadsheet program (Example 9-3.xls), the reaction conversion $x = 0.3316$

Reaction 2:



$$\text{Total} = 1 + 4x,$$

where x is reaction conversion

$$K_{eq} = \exp(a/T + b)$$

$$= \exp(-31.24 \times 10^3 / (500 + 273.15) + 53.4)$$

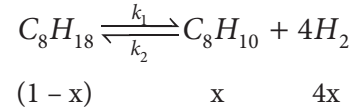
$$= 439709.36$$

$$K_{eq} = \frac{k_1}{k_2} = \frac{p_{C_7H_8} p_{H_2}^4}{p_{C_7H_{16}}} = \frac{(y_{C_7H_8} \cdot \pi)(y_{H_2} \cdot \pi)^4}{(y_{C_7H_{16}} \cdot \pi)}$$

$$K_{eq} = \frac{(y_{C_7H_8} \pi)(y_{H_2} \pi)^4}{(y_{C_7H_{16}} \pi)} = \frac{\left(\frac{x}{1+4x}\right) \pi \left(\frac{4x}{1+4x}\right)^4 \pi^4}{\left(\frac{1-x}{1+4x}\right) \pi}$$

$$x = 0.8818$$

Reaction 3:



$$\text{Total} = 1 + 4x,$$

where x is reaction conversion

$$K_{eq} = \exp(a/T + b)$$

$$= \exp(-29700 / (500 + 273.15) + 53.4)$$

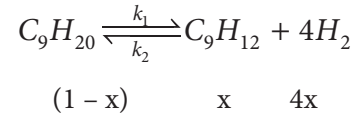
$$= 3.23 \times 10^6$$

$$K_{eq} = \frac{k_1}{k_2} = \frac{p_{C_8H_{10}} p_{H_2}^4}{p_{C_8H_{18}}} = \frac{(y_{C_8H_{10}} \cdot \pi)(y_{H_2} \cdot \pi)^4}{(y_{C_8H_{18}} \cdot \pi)}$$

$$K_{eq} = \frac{(y_{C_8H_{10}} \pi)(y_{H_2} \pi)^4}{(y_{C_8H_{18}} \pi)} = \frac{\left(\frac{x}{1+4x}\right) \pi \left(\frac{4x}{1+4x}\right)^4 \pi^4}{\left(\frac{1-x}{1+4x}\right) \pi}$$

$$x = 0.9804$$

Reaction 4:



$$\text{Total} = 1 + 4x,$$

where x is reaction conversion

Table 9.17 Composition of reformate produced.

Component	Moles	Composition
C_6H_6	$25 \times 0.3316 = 8.29$	0.0198
C_7H_8	$25 \times 0.8818 = 22.045$	0.0526
C_8H_{10}	$25 \times 0.9804 = 24.51$	0.0585
C_9H_{12}	$25 \times 0.9949 = 24.87$	0.0594
C_6H_{14}	$25 \times (1 - 0.3316) = 16.71$	0.0399
C_7H_{16}	$25 \times (1 - 0.8818) = 2.955$	0.00705
C_8H_{18}	$25 \times (1 - 0.9804) = 0.490$	0.00117
C_9H_{20}	$25 \times (1 - 0.9949) = 0.1275$	0.000304
H_2	318.87	0.7613
Total	418.87	1.0

$$\begin{aligned}
 K_{eq} &= \exp(a/T + b) \\
 &= \exp(-28940/(500 + 273.15) + 53.8) \\
 &= 1.2848 \times 10^6
 \end{aligned}$$

$$K_{eq} = \frac{k_1}{k_2} = \frac{P_{C_9H_{12}} P_{H_2}^4}{P_{C_9H_{20}}} = \frac{(y_{C_9H_{12}} \cdot \pi)(y_{H_2} \cdot \pi)^4}{(y_{C_9H_{20}} \cdot \pi)}$$

$$K_{eq} = \frac{(y_{C_9H_{12}} \pi)(y_{H_2} \pi)^4}{(y_{C_9H_{20}} \pi)} = \frac{\left(\frac{x}{1+4x}\right) \pi \left(\frac{4x}{1+4x}\right)^4 \pi^4}{\left(\frac{1-x}{1+4x}\right) \pi}$$

x = 0.9949

The composition of the reformate is calculated from the equilibrium conversion as shown in Table 9.17.

An Excel spreadsheet (Example 9-3.xlsx) program has been developed for Example 9-3 in determining the composition of the reformer product from the equilibrium reactions as shown above.

9.12 Thermodynamics

The dehydrogenation reactions are the main source of reformate product and are considered to be the principal reactions in the reforming process. These are highly endothermic reactions and require a great amount of heat to initiate and keep the reaction. This process thus requires three reactors, where the product from one reactor is heated before entering the next the following reactor. The dehydrogenation reaction is reversible and equilibrium is favored based upon temperature and pressure. The equilibrium for each reaction is determined, and in reforming process, a high temperature of 932 °F (500 °C) and a low hydrogen pressure are required. The minimum partial pressure of hydrogen

is calculated by the amount of the desired aromatic conversion.

The most rapid reactions (i.e., dehydrogenation of naphthenes) reach thermodynamic equilibrium, while the others are controlled by kinetics. Increasing the reaction temperature and lowering the pressure both have a positive effect on the reaction rate and thermodynamic feasibility as to the dehydrogenation of naphthenes, which is the most important reaction in catalytic reforming. The effect of these variables on thermodynamic equilibrium for the other reactions is minimal. The following effects of the main reforming reactions are:

1. The dehydrogenation of naphthenes and paraffins is rapid and equilibrium concentrations are established in the initial portions of a catalyst bed.
2. Olefins are readily hydrogenated and at equilibrium, only small concentrations can exist.
3. The isomerization of paraffins is a sufficiently rapid reaction and primarily thermodynamically controlled, i.e., that actual concentrations are near equilibrium.
4. The dehydrocyclization of paraffins is a much slower reaction and kinetically controlled.
5. Coking is very slow but increases rapidly at low hydrogen pressure and high temperature.

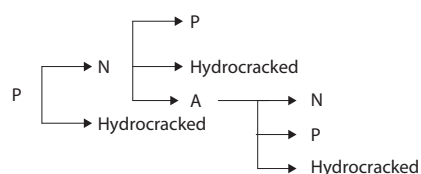
Table 9.18 summarizes the thermodynamic effect of the main reforming reactions.

9.13 Kinetic Models

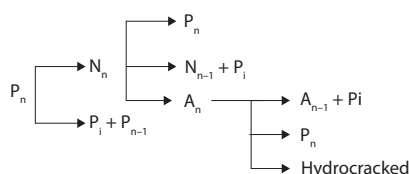
Experimental studies result in the development of creating a kinetic network that describes the path of a particular reactant. Because of the complexity of the reforming reactions and the number of species involved, a lumped approach towards describing the kinetics is generally adapted. In such an approach,

Table 9.18 General Thermodynamic Comparison of the Major Catalytic Reforming Reactions.

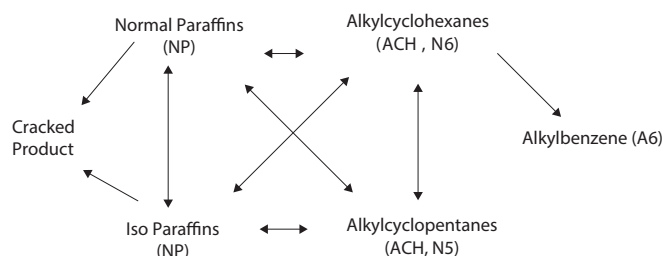
	Rate of reaction	Heat of reaction	Thermodynamic equilibrium
Naphthene dehydrogenation	Very fast	Very endothermic	Reached
Naphthene isomerization	Fast	Mildly exothermic	Reached
Paraffin isomerization	Fast	Mildly exothermic	Reached
Paraffin dehydrocyclization	Slow	Very endothermic	Not reached
Paraffin dehydrogenation	Very fast	Endothermic	Not reached
Hydrocracking	Very slow	Exothermic	Not reached



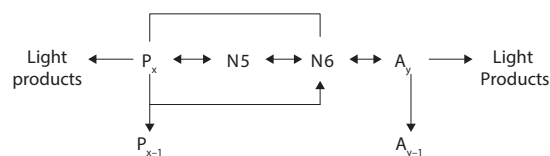
PNA – only model from Smith [6]



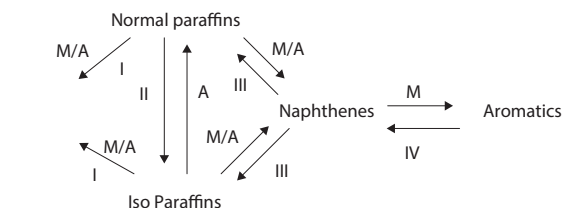
PNA – only model from Ancheyta – Juarez et al. [7, 8]



ACH and ACP model from Henningsen et al. [9]



C5 – C8 lumping method from Ramage et al. [10]



M – Metal catalyst A – Acid catalyst
 I – Hydrocracking II – Isomerization
 III – Dehydro-cyclizing IV – Dehydrogenation

Fahim, M. A., Al – Sahhaf, T. A., and A. S. El – Kilani [11]

Figure 9.7 Basic kinetic networks.

many different molecules are placed into a single group or lump. The reaction kinetics assumes that all species in a lump behave identically, and some models have been presented that involve hundreds of reaction species and thousands of reactions [4, 5], although these complex kinetic models have not been validated against an industrial operation.

Smith [6] provided a three-lump kinetic model for reforming that assumes that the feed is a combination of paraffins (P), naphthenes (N) and aromatic (A). The basic schematic of the network is illustrated in Figure 9.7. The kinetic accounts for dehydrocyclization ($P \rightarrow N$), dehydrogenation ($N \rightarrow A$) and hydrocracking ($A \rightarrow P$). The hydrocracking reactions in this model result in an equilibrium distribution of paraffins. However, this model does not include the effect of reaction parameters such as pressure and excess

hydrogen present. Additionally, there is no deactivation factor due to the presence of coke or heavy adsorbed hydrocarbons.

Krane *et al.* [12] provided an improved model by splitting up each P, N and A lump into groups corresponding to the number of carbons. The basic form of each rate expression on the 20 lumps model and 53 reactions is:

$$\frac{dN_i}{d\left(\frac{A_c}{W}\right)} = -k_i N_i \quad (9.1)$$

This model excludes the effect of catalyst activity and pressure. Henningsen *et al.* [9] consider the different rates of reactivity between C_5 and C_6 naphthenes and an activity factor for catalyst deactivation. Jenkins

et al. [13] include an empirical correction factor for acid and pressure in the rate expression. Ancheyta *et al.* [7, 8] introduced a similar pressure correction term to account for pressures other than 300 psig specified in the Krane *et al.* model. They later included additional pathways to account for methylcyclohexane (MCH) as a primary precursor to benzene [14] in the product pool and to deal with non-isothermal operation. Krane *et al.* and Ancheyta *et al.* models have been used to model a variety of reforming processes ranging from pilot plants to commercial operations. The modified rate expression is:

$$\frac{dN_i}{d\left(\frac{A_c}{W}\right)} = -k_i \exp\left[\left(E_i/R\right)\left(\frac{1}{T_o} - \frac{1}{T}\right)\right]\left(\frac{P}{P_o}\right)^\alpha P_i \quad (9.2)$$

Hennigsten *et al.* [9] provided separate pathways for cyclopentane and cyclohexanes and apply their model with a heat balance to account for the non-isothermal operation of the reactor. These works have been shown to agree with commercial and pilot-plant data.

$$\frac{dC_i}{dt} = \sum k_i \exp(E_i/RT) P_i \quad (9.3)$$

A limitation of the models derived from Krane *et al.*, and Hennigsten *et al.* is that the reaction network does not account as a catalytic process that includes terms to allow for inhibition and decrease in activity due to a variety of factors. Raseev *et al.* [15] treated the reaction network as a catalytic system. However, their study is limited due to the lack of experimental data. Ramage *et al.* [10] presented independent pathways for cyclohexanes and cyclopentanes in addition to adsorption and pressure effects. However, this model is limited by the lumping into only C_5^- and C_5^+ . Kmak presents a similar model that extends the lumping to include C_7 components [16].

$$\frac{dw_i}{dv} = \frac{\left(\frac{PV}{FRT}\right)k_\phi}{1 + K_H P_H + (PF_c/F)\sum k_{wi} w_i} \sum k_{wi} w_i \quad (9.4)$$

Ai-Fu *et al.* [17] have described other lumped kinetic network and there are recent advances in computational power and molecular modeling work by other researchers. They provided a simulation of the model for UOP CCR reformer from a refinery in the Asia-Pacific processing hydrotreating naphtha. They

compared the overall reactor yield and operating profiles for key equipment for the gas plant and showed that the model accurately predicts the product yield, composition and operating profiles over a wide range of feed conditions.

9.14 The Reactor Model

The feed (naphtha) enters the reactor in the gas phase and in contact with the solid catalyst (i.e., catalytic reforming is conducted as a gas-solid reaction). Radial and axial dispersion effects are neglected since the reactor diameter and length are much larger than the diameter of the catalyst particle. Additionally, under steady-state conditions, the catalyst activity is assumed to be constant. Therefore, commercial semi-regenerative reforming reactors can be represented by the one-dimensional pseudo-homogeneous adiabatic model. The following ordinary differential equations constitute the reactor model, which are integrated through each reactor bed to describe the reformate composition, temperature and pressure profiles along the length of the reactors. The mass balance, heat balance and the Ergun equation used to predict the total pressure drop of the reactor are:

$$-\frac{dy_i}{dz} = \frac{MW_i}{z \cdot WHSV} r_i \quad (9.5)$$

$$\frac{dT}{dz} = \frac{S \sum_{i=1}^{NR} r_i (-\Delta H_{Ri})}{\sum_{i=1}^{NC} F_i C_{pi}} \quad (9.6)$$

$$-\frac{dP}{dz} = 1.75 \times 10^{-5} \frac{(1-\varepsilon)}{\varepsilon^3} \frac{G^2}{\rho d_p g_c} + 1.5 \times 10^{-3} \frac{(1-\varepsilon)}{\varepsilon^3} \frac{G^2}{\rho d_p^2 g_c} \quad (9.7)$$

Equations 9.5 to 9.7 are solved simultaneously with the kinetic model rate equation for each component (r_i) using the fourth-order Runge-Kutta method. To solve the energy balance equation 9.6, heats of reaction (ΔH_{Ri}) are necessary, which are determined by the following equations:

$$\Delta H_R = \sum \nu_p H_{fp} - \sum \nu_r H_{fr} \quad (9.8)$$

$$H_{fi} = H_{fi}^o + \int_{298K}^T C_p dT \quad (9.9)$$

$$C_p = A + BT + CT^2 + DT^3 \quad (9.10)$$

The values of heats of formation H_f° and the constants A, B, C and D for calculating the specific heats C_{pi} are reported by Ancheyta [34].

9.15 Modeling of Naphtha Catalytic Reforming Process

Modeling and simulation of naphtha catalytic reforming process have been carried out in order to optimize the reforming process for the new design process, troubleshooting, monitoring process performance, diagnosing faults and process control. Larraz [35] carried out simulation on naphtha reforming by finding out how feed composition and operating conditions affect product compositions and the yield.

Modeling of reforming reactions can be carried by using correlation models or kinetic models as reviewed earlier. Reaction kinetics has a principal role in catalytic reforming model performance. Kinetic models can handle independent, feed forward and reverse reactions and are tools for predicting individual component yields as well as yield patterns such as C_5^+ yield in a reformer. A kinetic-based model for commercial catalytic reforming process has been reported by Ai-Fu *et al.* [17], and Hu *et al.* [36] for predicting reaction temperature and concentration profiles of each reactor, heater duties, catalyst deactivation, recycle gas composition and octane number resulting from different feedstocks or operating conditions. Jorge and Eduardo [37] have proposed a lumped kinetic model for naphtha catalytic reforming process. Saxena *et al.* [38] reported a simulation (Simpack) and optimization package (Refopt) that are employed for the design and optimal operation of semi-regenerative type catalytic reformers.

9.16 Isomerization

The isomerization process is used to rearrange straight chain molecules into branched molecules. The primary uses of this process in oil refineries are to convert *n*-butane into isobutane and to convert the C_5/C_6 normal paraffins in light gasoline (C_5 to 180 °F [82.6 °C]) into the corresponding isoparaffins. Light straight chain paraffins of low Research Octane Number (RON) (C_4 , C_5 , and C_6) are transformed with proper catalyst into branched chains with the same carbon number

and high octane numbers. The hydrotreated naphtha (HTN) is fractionated into heavy naphtha between 190–380 °F (90–190 °C) and this is used as feed to the reforming unit. The light naphtha C_5^- 180 °F (80 °C) is used as feed to the isomerization unit. There are two reasons for this fractionation: the first is that light hydrocarbons tend to hydrocrack in the reformer. The second is that C_6 hydrocarbons tend to form benzene in the reformer, and gasoline specifications require a very low value of benzene due to its carcinogenic effect.

Most of the implemented legislation requires limiting benzene concentration in the gasoline pool. This has increased the demand for high-performance C_5 and C_6 naphtha isomerization because of its ability to reduce the benzene concentration in the gasoline pool while maintaining or increasing the octane pool. The UOP Penex process is a fixed-bed process that uses high-activity chloride promoted catalysts to isomerize C_5/C_6 paraffins to higher octane branched components. The reaction conditions promote isomerization and minimize hydrocracking. Two reactors in series flow are used to achieve high on-stream efficiency. The catalyst can be replaced in one reactor while operation continues in the other. The stabilizer separates the light gas from the reactor effluent.

In once-through isomerization where the normal and iso compounds come essentially to thermodynamic equilibrium, the unleaded RON of LSR naphtha can be increased from 70 to 84. If the normal components are recycled, the resulting RON will be 87–93 RON. The reaction temperatures of about 200–400 °F (95–205 °C) are preferred to higher temperatures because the equilibrium conversion to isomers is enhanced at the lower temperatures. At these relatively low temperatures, a very active catalyst is necessary to provide a reasonable reaction rate. The available catalysts used for isomerization contain platinum on various bases. Some types of catalyst (alumina support) require the continuous addition of very small amounts of organic chlorides to maintain high catalyst activities. This is converted to hydrogen chloride in the reactor, and consequently the feed to these units must be free of water and other oxygen sources in order to avoid catalyst deactivation and corrosion problems. The second type of catalyst uses a molecular sieve base and can tolerate feeds saturated with water at an ambient temperature [39]. The third type of catalyst contains platinum supported on a novel metal oxide base. This catalyst operates at 150 °F (83 °C) than conventional zeolite isomerization catalysts and can be regenerated. Catalyst life is usually 3 years or more with all these catalysts.

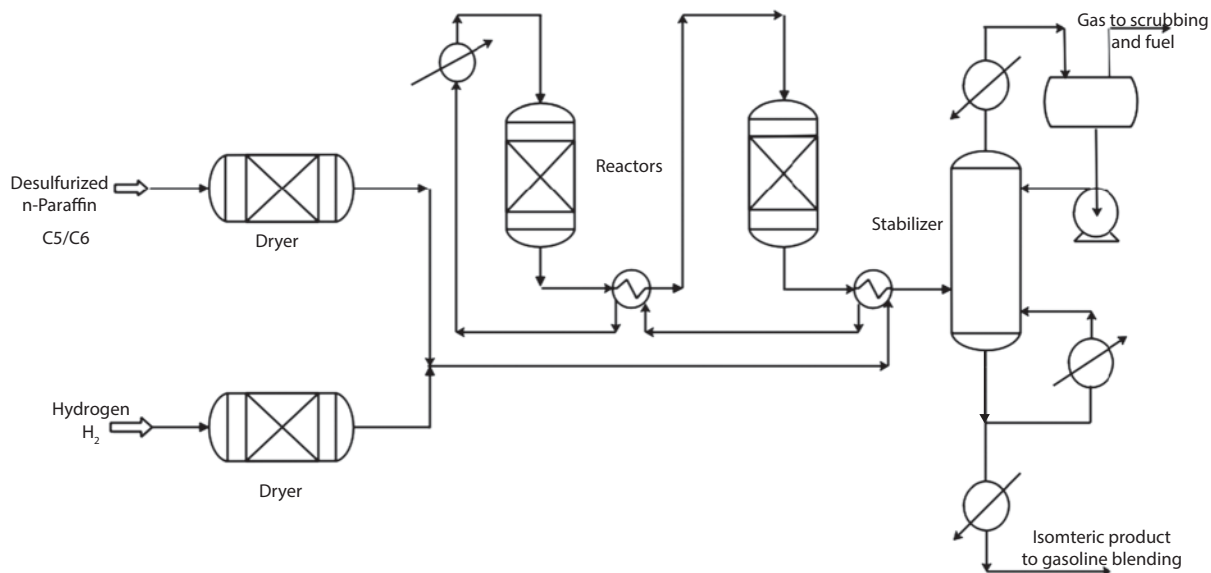


Figure 9.8 Flow diagram of Penex™ isomerization unit (Source: *Hydrocarbon Processing 2011 Refining Process Handbook*).

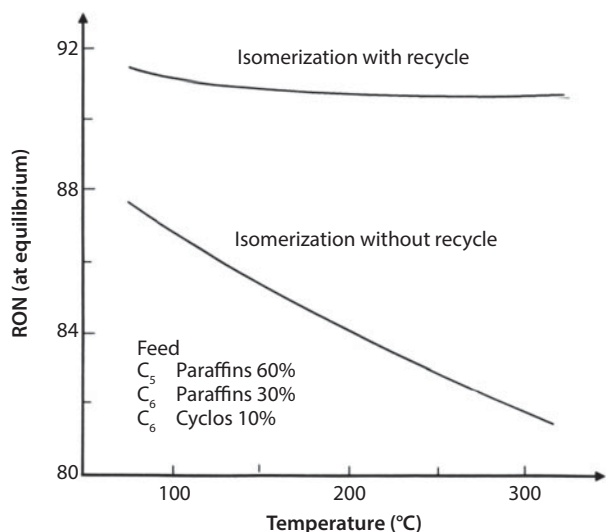


Figure 9.9 Thermodynamic equilibrium with and without recycle normal paraffin.

The composition of the reactor products can approach chemical equilibrium, as the actual product is dependent on the type and age of the catalyst, the space velocity (LHSV or WHSV), and the reactor temperature. For typical C₅/C₆ feeds; equilibrium will limit the product to 83 to 86 RONC on a single hydrocarbon pass basis. In achieving higher octane, UOP provides schemes in lower octane components are separated from the reactor effluent and recycled back to the reactors. These recycle modes of operation can yield product octane as high as 93 RONC, depending on feed quality.

Some hydrocracking occurs during the reactions that result in a loss of gasoline and the production of light gas. The amount of gas formed varies with the catalyst type and age and can impact the costs. The light gas produced is typically in the range of 1.0–4.0 wt% of the hydrocarbon feed to the reactor. As preliminary estimates, the composition of the gas produced can be 95 wt% methane and 5 wt% ethane [1]. Figure 9.8 shows a process flow scheme of UOP hydrogen-once-through (HOT) unit. Typical operating conditions:

Reactor temperature	200–400 °F	95–205 °C
Pressure	250–500 psig	1725–3450 kPa
Hydrogen/HC mole ratio	0.05/1	
Single pass LHSV	– 2 v/hr/v	
Liquid product yield	>98 wt%	

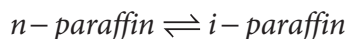
9.16.1 Thermodynamics

The isomerization reactions are slightly exothermic, and the reactor operates in equilibrium mode. There is no change in the number of moles, and the reaction is not affected by pressure change. However, greater conversions are achieved at a lower temperature as illustrated in Figure 9.9, as the degree of conversion to iso-paraffins is measured by the increase of the RON [40]. Recycling the paraffin greatly enhances the conversion.

A good result is achieved by operating the reactor at a temperature of 260 °F (130 °C).

9.16.2 Isomerization Reactions

Isomerization of *n* - paraffins is a reversible and slightly exothermic reaction.



The conversion to iso-paraffin is incomplete since the reaction is equilibrium limited, as it does not depend on pressure, but it can increase by lowering the temperature. But a lower temperature reduces the reaction rate, and this requires a very active catalyst to compensate for the reduction in temperature.

9.17 Sulfolane Extraction Process

The present separation methods for recovery of aromatics from hydrocarbon streams use liquid-liquid solvent extraction to separate the aromatic fraction from the other hydrocarbons. The two main extracting solvents are polyglycols and Sulfolane. The polyglycol process is the Udex process developed by Dow Chemical Co. and licensed by UOP. The Sulfolane process was originally developed by the Royal Dutch/Shell group and is licensed by UOP. Sulfolane (Tetrahydrothiophene 1-1 dioxide (CH₂)₄SO₂) is a cyclic compound having a

strongly polar molecule that is very highly selective for aromatics and yet possesses a large solvent capacity for hydrocarbons. The requirements for a solvent are [41]:

- High selectivity for aromatics versus non-aromatics
- High capacity (solubility of aromatics)
- Capability to form two phases at reasonable temperatures
- Capability of rapid phase separation
- Good thermal stability
- Non-corrosivity and non-reactivity

The sulfolane solvent process uses a combination of liquid-liquid extraction and extractive stripping to separate the aromatics from the other hydrocarbons because of the characteristics of the polar solvent. Aromatics and non-aromatics are from the platformer, where aromatics are generated. The aromatics are dissolved in sulfolane and the mixture becomes the extract phase (bottom), where the remaining non-aromatics stream forms the raffinate phase (tops).

As the concentration of aromatics in the solvent increases, the solubility of the nonaromatic hydrocarbons in the extract phase also increases. This results in a decrease in the selectivity of the solvent and a carry-over of some of the non-aromatic hydrocarbons with the extract phase to an extractive stripper.

In the stripper, an *n* extractive distillation occurs as the non-aromatic hydrocarbons are stripped from the aromatic-solvent mixture and returned as reflux to the extraction column. The solvent is then recovered from the non-aromatic hydrocarbon-free extract stream, leaving an extract that contains less than 1000 ppm (<0.1%) aliphatics. The aromatic recoveries are 99.9, 99.0, and 97.0% for benzene (C₆H₆), toluene (C₇H₈) and xylene (C₈H₁₀), respectively. Figure 9.10 shows the activity coefficient or K values for each section of the separation. The K value in extraction is a measure of the solvent's ability to repel component, *i* and is defined as the mole fraction of component, *i* in the hydrocarbon phase X_{*i*} divided by the mole fraction of component, *i* in the solvent phase Z_{*i*}. The lower the value of K_{*i*}, the higher the solubility of component *i* in the solvent phase.

Sulfolane is recovered from the raffinate first in a coalescer and then in water wash column. This is due to the high affinity of the polar solvents for water and the low solubilities in the non-aromatic hydrocarbons raffinate phase. The water is returned to the extract recovery column (Sulfolane) for recovery of the solvent. The

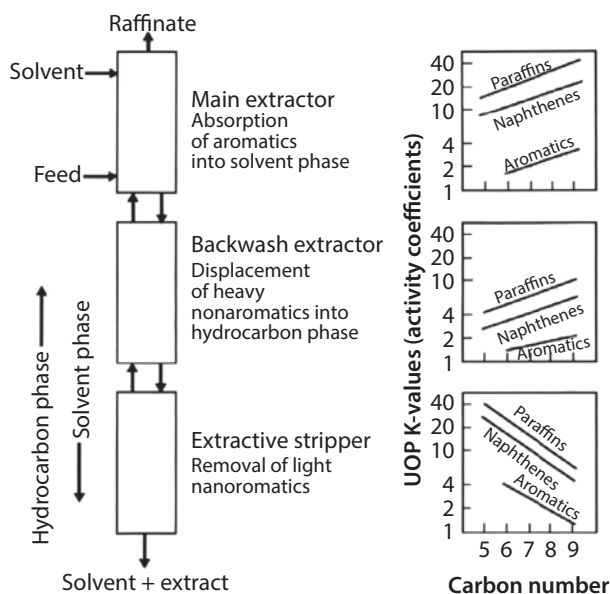


Figure 9.10 Sulfolane process concept (Source: Thomas, J. Stoodt and Antoine Negiz, Chapter 2.2. UOP Sulfolane Process, Robert A. Meyers, *Handbook of Petroleum Refining Processes*, 3rd ed., McGraw-Hill Handbooks, 2003).

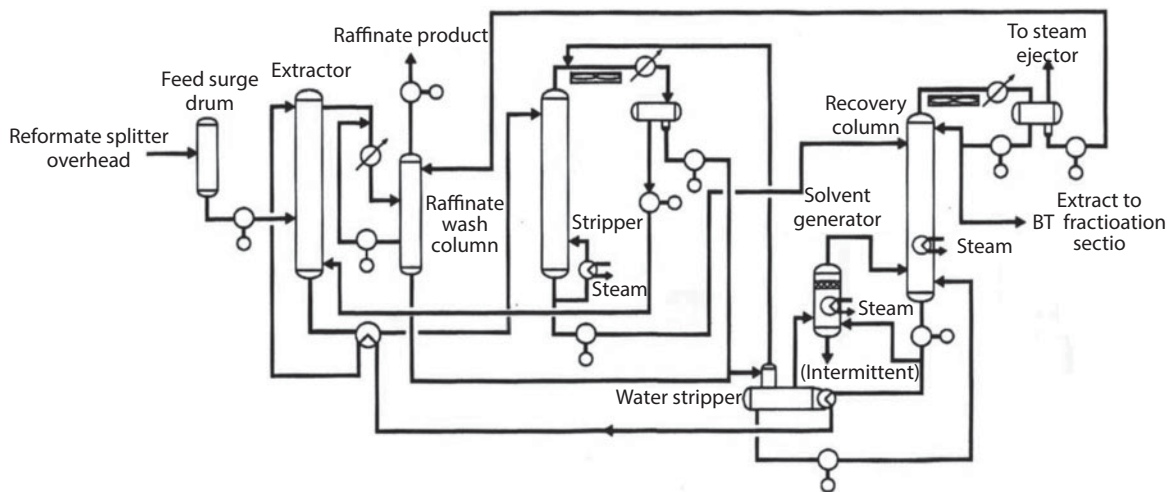


Figure 9.11 Sulfolane process flow diagram. (Source: Thomas, J. Stoodt and Antoine Negiz, Chapter 2.2. UOP Sulfolane Process, Robert A. Meyers, *Handbook of Petroleum Refining Processes*, 3rd ed., McGraw-Hill Handbooks, 2003).

Table 9.19 Aromatics yield as a function of severity.

Product RON	Percent aromatics
90	54
95	60
100	67
103	74

water content of the solvent is controlled and used to increase the selectivity of the solvent. The final raffinate is pumped to naphtha blending as gasoline components. Figure 9.11 shows a schematic of the sulfolane process. Table 9.19 shows the increase in aromatics yields as the reformer operating severity is increased (the clear research octane number RON is the measure of operating severity). The Benzene is sent to the petrochemical plant for the manufacture of styrene.

Sulfolane as a solvent is contaminated during the extraction process. The solvent readily decomposes at a temperature of 392 °F (200 °C) and 516 °F (269 °C) respectively. The oxygen presence in the molecule accelerates its decomposition, and high corrosion at paraffin stripper and aromatic stripper reboiler temperatures of 350 °F–380 °F (177 °C– 193 °C), and the reboiler and their associated equipment can be subjected to corrosion. Furthermore, the solvent degradation products include sulfur dioxide (SO₂), acids and polymers. Acids can be destructive, and many polymers are miscible in Sulfolane. Those that stay in solution reduce the power of the solvent.

Sulfolane is a good solvent for capturing acid gases and mercaptans. Any acid gas evolving from Sulfolane decomposition or associated corrosion could be retained in solution throughout the extraction unit that interacts with degradation products and therefore, accelerates corrosion. This could enhance the by-products to the solvent flow, including, iron solids, acid salts and polymer solids. These accumulating wastes can cause corrosion/erosion, foul equipment and reduce the power of the solvent. Regeneration of the solvent is required to remove heavy material evolving from solvent decomposition and the accompanied unit corrosion. Schneider [43] has examined the operation and design issues associated with the three prevalent types of solvent regenerators, namely: steam assisted, reboiled and flash.

9.17.1 Sulfolane Extraction Unit (SEU) Corrosion Problems

Sulfolane corrosion/erosion problems are caused by the following:

- Oxygen in the plant (ingress or via incoming flows)
- Chlorine in circulating solvent
- Accumulation of degradation and corrosion products in the plant
- High temperatures in the reboilers

Oxygen

Oxygen in contact with Sulfolane at the conditions in the SEU plant leads to rapid degradation of the solvent.

The most likely places for oxygen entering the system are the vacuum parts of the unit, dissolved oxygen in the feed and in fresh or wet solvent supply.

In determining where oxygen ingress takes place, it will be required to check all flanges in the vacuum system, the tightness of the vacuum system and perform both pressure and vacuum tests. In reducing oxygen in the SEU via the platformate feed, it is often recommended to send the feed directly to the SEU with the tank floating on the line. This is performed during the shutdown of the SEU.

Chlorine

Chlorine (Cl_2) can form hydrochloric acid (HCl) in the hotter parts of the unit and will, therefore, be very corrosive. Chlorine can enter the unit with the platformate feed (usually 1 ppm wt or less) or via cooling (sea) water leaks. Furthermore, Cl_2 originates from the platformer feed as leaking sea water coolers can cause water build-up in the plant. Since there is insufficient analytical data, it is advisable to check the Cl_2 content of the fat solvent, lean solvent and water in the solvent tanks regularly in order to establish a reference data set, and thus allow monitoring the changes achieved by operational actions.

Accumulation of degradation and corrosion products

After many cycles of operation of SEU, degradation and corrosion products will build up in the plant. Dirt accumulated in the plant is usually corrosive and can act as a catalyst to make more degradation products. Dirt can also build up in the rotating disc contactor (RDC) of the SEU (e.g., a typical unit found 10–15 m³ dirt, and a fair amount came out of the RDC after its internals were scraped with a cake of about 5 cm on both sides of the RDC discs). Another location where dirt can accumulate is the steam regenerator. The amount of dirt/fines in the plant can increase the foaming tendency of the solvent and thus make the separation of two phases in the bottom of the RDC more difficult.

Ensuring that there is less build-up of dirt, the SEU equipment, its lines and the RDC and its internals are cleaned thoroughly during shutdown of the unit.

High Steam and Reboiler Temperatures

The temperature has a large effect on the degradation of Sulfolane by oxidation. To minimize the temperature

effect, it is advisable to operate always at a temperature not lower than 347 °F (175 °C) on the process side and at a condensation temperature of maximum 401 °F (205 °C) on the steam side of the reboiler.

9.17.2 Other Solvents for the Extraction Unit

Commercial processes have been based on solvents as Sulfolane, N – methyl pyrrolidone, ethylene glycol, N- formylmorpholine and dimethylsulfoxide (Table 9.20). These solvents have a number of common characteristics. They all have densities and boiling points that are higher than the material to be extracted, and all are to a greater or lesser extent polar molecules or water soluble. Each of these properties has a definite influence on the type of equipment used and the process flowsheet. For example, a large density difference is desirable for the counter current flow of the phases and the settling in the extraction column, while a high boiling point allows simple separation of the solvent from the extract by distillation. Furthermore, regarding solvent polarity, which strongly influences selectivity for aromatics, it is often necessary to add a polar mixing component to the solvent in order to improve its selectivity. The addition of water generally serves this purpose in the case of dimethylsulfoxide, N – formylmorpholine and N – methyl pyrrolidone.

9.18 Aromatic Complex

Aromatic production involves catalytic reforming of naphtha, separation of non-aromatics, separation of aromatics and transalkylation and isomerization process. Kim *et al.* [42] indicated that proper control is necessary for the best choice of feedstocks; appropriate identification of reformer feed cut points, adequate selection of reformer severity and the production of benzene and para-xylene. A typical aromatic complex consists of the following steps [30]:

1. Catalytic reforming of naphtha to produce reformate containing aromatics.
2. Separation of non-aromatics from aromatics using liquid-liquid extraction or extractive distillation.
3. Separation of benzene, toluene, and xylene from reformate by fractional distillation.
4. Disproportionation and transalkylation of toluene to benzene.

Table 9.20 Solvents for the separation of Benzene – Toluene – Xylene mixtures from light feedstocks.

Solvent	Process	Solvent additives	Operating temperature	Extractor	Solvent Recovery
Glycol/water mixtures	UDEX process, Universal Oil Products	Solvent can be aqueous diethylene glycol, perhaps with dipropylene glycol or tetraethylene glycol and water	150°C for diethylene glycol and water	Sieve tray extractor	Distillation
Tetraethylene glycol	Union Carbide Corp.	The solvent is free of water	100°C	Sieve tray extractor	Secondary extraction of BTX into dodecane followed by distillation
Sulfolane	Shell process	None	120°C	Rotating Disc Contactor (RDC) or sieve tray	Distillation
N – Methyl pyrrolidone (NMP)	Arosolvan process, Lurgi	Either water or monoethylene glycol added to improve selectivity	NMP/glycol, 60°C NMP/water, 35°C	Vertical multistage mixer – settler	Distillation
Dimethyl sulfoxide (DMSO)	Institut Francais du Petrole	Solvent contains up to 9% water to improve selectivity	Ambient	Mechanically agitated contactor, e.g., Kuhni column	Aromatics are displaced from DMSO in a second extraction step. Then recovery of secondary paraffinic solvent is by distillation.
N – Formyl – morpholine (FM)	FORMEX process, Snamprogetti	Water addition increases selectivity and also avoids high reboiler temperature during solvent recovery by distillation.	40°C	Sieve tray extractor	Usually by distillation, but if benzene content of feedstock is negligible, a secondary extraction with a hydrocarbon solvent is used to remove BTX from the FM
Morpholine derivatives	AROMEX process, Krupp - Koppers	4-5 wt % water content to improve selectivity	Not known	Sieve tray extractor	Distillation

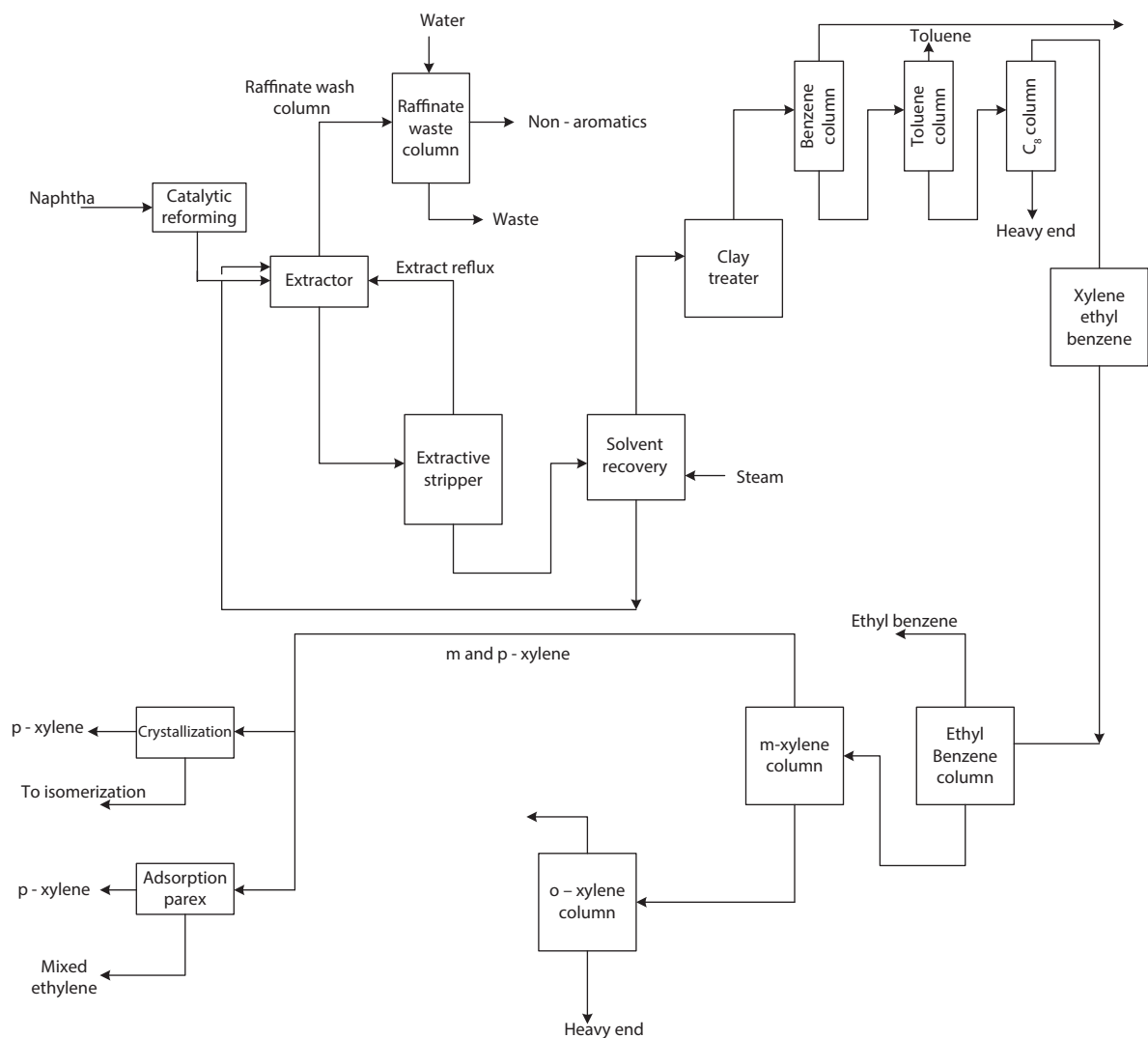


Figure 9.12 Aromatic production (Source: Indra Deo Mall, *Petroleum Refining Technology*, CBS Publishers & Distributors Pvt Ltd., 2015).

5. Separation of o - xylene from mixed xylenes by fractional distillation.
6. Separation of p - xylene from m - xylene by adsorption or crystallization.
7. Isomerization of m - xylene to produce p - xylene.

Figure 9.12 shows a schematic of aromatic production process.

9.18.1 Aromatic Separation

Benzene (C_6H_6) and toluene (C_7H_8) are recovered from the extract product stream of the extraction unit by distillation. The boiling points of the xylene (C_8H_{10}) aromatics are so close together (Table 9.21) that separation by distillation is difficult and thus a combination of

distillation and crystallization or adsorption is employed. The ethylbenzene ($C_6H_5C_2H_5$) is first separated from the mixed xylenes in a three-unit distillation tower with 120 trays per unit in a total of 360 trays. Each unit is about 200 ft (61 m) in height and is connected so that they operate as a single distillation tower of 360 trays. High reflux ratio is applied to provide the desired separation efficiency since the difference between the boiling points of ethylbenzene and p - xylene is only about 35.6 °F (2 °C). This process is energy-intensive operation, and as such it is usually less costly to make ethylbenzene by alkylating benzene with ethylene.

Figure 9.13 shows a process flow diagram sequence for the separation of C_8 aromatics. Removal of ethylbenzene is carried out by super-fractionation, the o - xylene along with the higher-boiling C_{9+} aromatics are separated from the p - and m - xylenes by fractionation.

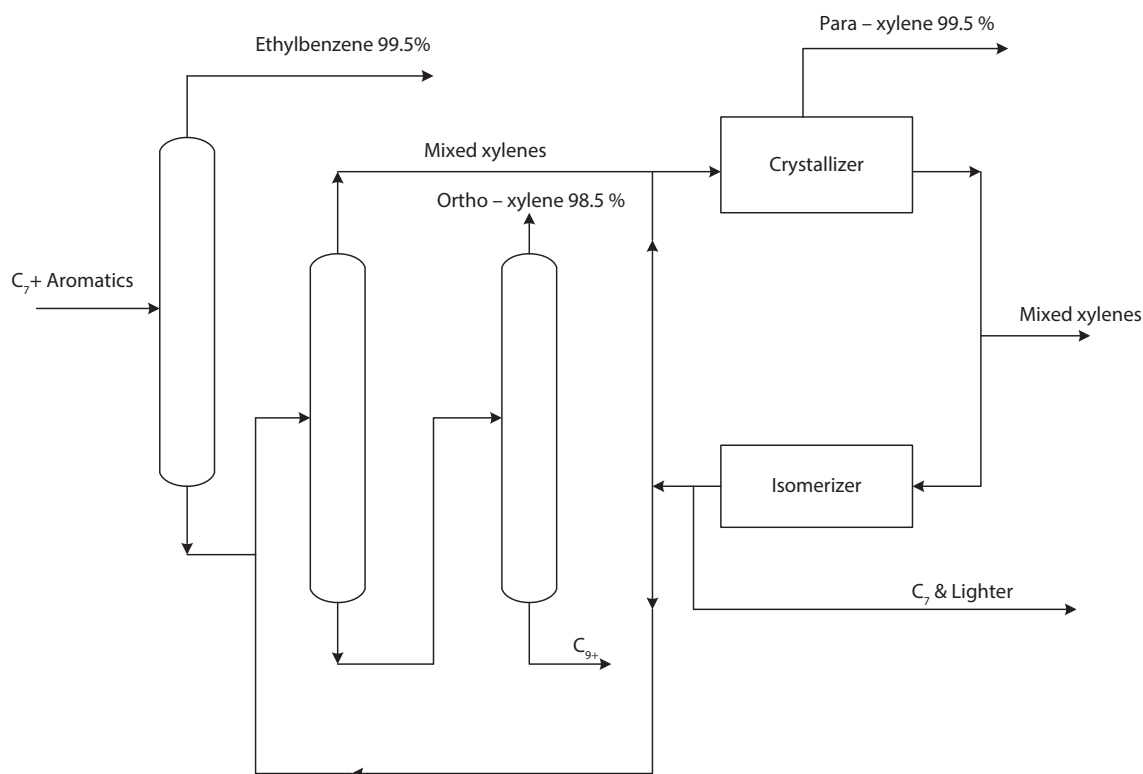


Figure 9.13 Process flow diagram of producing xylene (C_8H_{10}) aromatics.

Table 9.21 Boiling and melting points of aromatics.

	Boiling points		Melting points	
	°F	°C	°F	°C
Benzene	176.2	80.1	42.0	5.5
Toluene	231.2	110.6	-139.0	-95.0
Ethylbenzene	277.1	136.2	-139.0	-95.0
p - xylene	281.0	138.4	55.9	13.3
m - xylene	282.4	139.1	-54.2	-47.9
o - xylene	291.9	144.4	-13.3	-25.2

The boiling point of o - xylene is more than 41.0 °F (5 °C) greater than that of its closest isomer, m - xylene and can thus be separated in a distillation column. The overhead stream from this column is a mixture of m - and p - xylenes, and the bottom stream contains o - xylene and the C_{9+} aromatics. Here, an adsorbent is selected such that p - xylene molecules are adsorbed and the m - xylene molecules pass through the adsorbent bed. Recoveries of 96% per pass of pure p - xylene can be achieved [42] as compared with 60–65% recovery of

p - xylene by the freeze-crystallization process. The p - xylene is stripped from the adsorbent with p - diethyl benzene or a mixture of dimethylbenzene isomers.

Using crystallization for separation, the mixed m - and p - xylene overhead stream from the fractionating column is fed to the crystallization unit to separate the m - and p - xylenes. The solidification point of p - xylene is 55.9 °F (13.3 °C) and that of m - xylene is -54.2 °F (-47.9 °C).

9.19 Hydrodealkylation Process

The process is designed to produce high-purity benzene by hydrodealkylation of toluene and xylene. The toluene and xylene feedstock is prepared by the platformer with sulfolane extraction unit and subsequent distillation of the extract. The mixed aromatics and hydrogen at 1202 °F (650 °C) are fed to a reactor where the aromatics are dealkylated to form benzene, methane, and ethane. The high-purity benzene is recovered from the reactor product mixture by distillation and sent to tankage. The unrecovered aromatics are recycled to the feed.

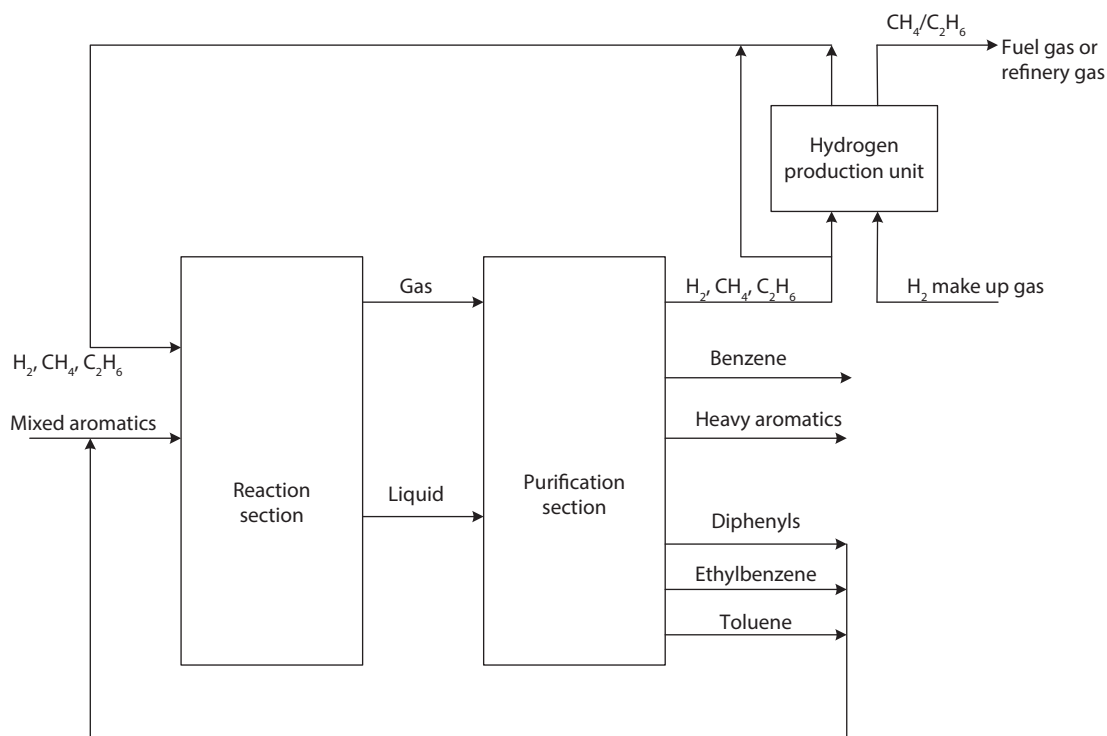
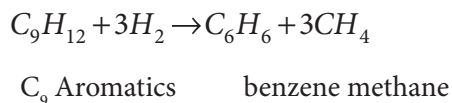
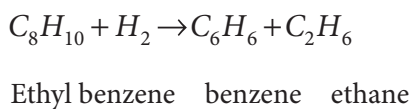
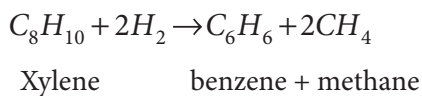
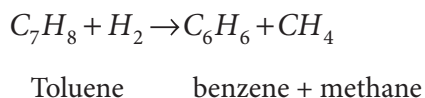


Figure 9.14 A block diagrams of hydrodealkylation process.

Reactions

The basic reactions involved in this hydrodealkylation unit are exothermic and are as follows:



However, the reaction proceeds sequentially for higher aromatics than toluene as shown below for xylene:



The reaction of toluene to benzene goes at a slower rate than the conversion of heavier aromatics as in the case of xylene to toluene. Consequently, the unconverted aromatics compounds in the reactor effluent will be largely toluene. Figure 9.14 shows a block diagram of the hydrodealkylation unit.

9.19.1 Separation of the Reactor Effluents

In the purification section, the gaseous and liquid effluents are separated to give:

- A H₂ rich gas sent to hydrogen purification unit to recycle the H₂ fraction.
- Benzene product is sent to storage.
- Toluene, ethylbenzene, diphenyls are recycled to the reaction section.
- Heavy aromatics are sent to storage.

References

1. Gary, James, H., Handwerk, Glenn, E. and Mark. J. Kaiser, *Petroleum Refining: Technology and Economics*, 5th ed., CRC Press, 2007.

2. Kugelman, Alan M., What Affects Cat Reformer Yield?, *Hydrocarbon Processing*, p. 95–102, January 1976.
3. Little, D., *Catalytic Reforming*, Pennwell Book, Tulsa, OK, 1985.
4. Froment, G. F., *Catalysis Reviews*, 47, 83–124, 2005.
5. Wei, W., Bennet, C. A., Tanaka, R., Hou, G., and M. T. Klein, *Fuel Process Technology*, 89, 344–349, 2008.
6. Smith, R. B., *Chemical Engineering Progress*, 55, 76–80, 1959.
7. Aguilar-Rodriguez, E., and J. Ancheyta-Juarez., *Oil & Gas Journal*, 92, 80–83, 1994.
8. Ancheyta-Juarez, J., E., Aguilar-Rodriguez, *Oil & Gas Journal*, 92, 93–95, 1994.
9. Henningsten, J., M. Bundgaard-Nielson, *British Chemical Engineering* 15, 1433–1436, 1970.
10. Ramage, M. P., Graziani, K. R., Schipper, P. H., Krambeck, F. J., and B. C. Choi, *Advances in Chemical Engineering*, 13, 193–266, 1987.
11. Fahim, M. A., Al-Sahhaf, T. A., and A. S. El-Kilani, *Fundamentals of Petroleum Refining*, Elsevier, 2010.
12. Krane, H. G., Groth, B. A., Schulman, L. B., and H. J., Sinfeld, *Fifth World Petroleum Congress Section III*, New York, 39, 1959.
13. Jenkins, H., Stephens, T. W., *Hydrocarbon Processing*, November, 163–167, 1980.
14. Ancheyta-Juarez, J., Macias-Villafuerte, E., Schachat, P., Aguilar-Rodriguez, E., E. Gonzales-Arrendondo, *Chem. Eng., Technol*, 25, 541–546, 2002.
15. Raseev, S., *Thermal and Catalytic Processes in Petroleum Refining*, Marcel Dekker, New York, 2003.
16. Kmak, W. S., AIChE National Meeting, Houston, TX, 1972.
17. Ai-Fu Chang, Kiran Pashikanti, and Y. A. Liu, *Refinery Engineering, Integrated Process Modeling and Optimization*, Wiley – VCH, 2012.
18. Kaes, Gerald L, *Refinery Process Modeling – A Practical Guide to Steady State Modeling of Petroleum Processes*, 1st ed., Kaes Enterprises, Inc., 2000.
19. Turpin, L. E., Cut benzene out of Reformate, *Hydrocarbon Processing*, p. 81–92, June, 1992.
20. Antos, G. J., and A. M. Aitaini, *Catalytic Naphtha Reforming*, 2nd ed., Marcel Dekker, New York, 2004.
21. Hosten, L. H., and G. F. Froment, *Ind. Eng. Chem., Process Des. Develop*, 10, 280–287, 1971.
22. Selman, D. M., and A. Voorhies, *Ind. Eng. Chem. Prod. Res. Dev.*, 14, 118–123, 1975.
23. Froment, G. F., *Chemical Engineering Science*, 42, 1073–1087, 1987.
24. Menon, P. G., and Z. Paal, *Ind. Eng. Chem. Res.*, 36, 3282–3291, 1997.
25. Thorton, D. P., *Petro/Chem. Eng.*, 41 (5), pp 21–29, 1969.
26. Lapinski, M. P., Zmich, J., Metro, S., Chaiyasit, N., and K. Worasinsiri, Increasing Catalytic Reforming Yields, *PTQ Catalysis*, p. 23–25, 2008.
27. Maples, R. E., *Petroleum Refining Process Economics*, PennWell Book, Tulsa, 1993.
28. Gary, J. H., and G. E., Handwerk, *Petroleum Refining*, Marcel Dekker, New York, 2001.
29. Stine, M., CCR Platforming™ Process – Advancements and Consideration of Supersized Units. *Hydrocarbon, Asia*, p. 12, May/June, 2006.
30. Indra Deo Mall, *Petroleum Refining Technology*, CBS Publishers & Distributors Pvt Ltd., 2015.
31. Saxena, A. K., *Catalytic Reforming, Advances in Petroleum Refining*. Petrotech Summer School, IIPM Gurgaon, 5th July 2006.
32. Raseev, S., *Thermal and Catalytic Processes in Petroleum Refining*, Marcel Dekker Inc., New York, p. 749, 2003.
33. Menon, P. G., and Paal, Some Aspects of the Mechanisms of Catalytic Reforming Reactions, *Ind. Eng. Chem. Res.*, Vol. 36, p 3282, 1997.
34. Ancheyta Jorge, *Modeling and Simulation of Catalytic Reactors for Petroleum Refining*, John Wiley & Sons, Inc., 2011.
35. Larraz, R., Benzene Reduction in Naphtha Catalytic Reforming, *Petroleum Technology, Quaterly Journal*, p 61, Autumn 2001.
36. Hu, Y, Su, H and J. Chu., Modeling, Simulation and Optimization of Naphtha Catalytic Reforming Process. *Proceedings of the 42nd IEEE Conference on Decision and Control, Maui, Hawaii, FrE04–1, USA Dec. 2003*.
37. Jorge, A. J., and V. M. Eduardo, Kinetic Modeling of Naphtha Catalytic Reforming Reactions. *Energy Fuels*, Vol. 14, No. 5, p 1032, 2000.
38. Saxena, A. K., Das, G., Goyal, H. B., Kapoor, V. K., Singh, H., and M. O. Garg, *Simulation, and Optimization Package for Semiregenerative Catalytic Reformer. Hydrocarbon Technology*, p. 71, Aug. 15, 1994.
39. Kouwenhoven, H. W., and Van Z. Langhout, *Chem. Eng. Prog.*, 67 (4), pp 65–70, 1971.
40. Travers, C., Isomerization of light paraffins, Chapter 6 in *Conversion Processes, Petroleum Refining*, vol. 3, Leprince, P., ed., TECHNIP, France, 2001.
41. Thomas, C. L., *Catalytic Processes and Proven Catalysts*, Academic Press, New York, 1970.
42. Mowry, J. R., *Handbook of Petroleum Refining Processes*, Meyers, R. A., Ed., McGraw-Hill Book Co., New York, pp 10–12, 1986.
43. Schneider, D. F., Extraction Unit Sulfolane Solvent Regeneration, dfsstratus@aol.com, 2003.

10

Alkylation and Polymerization Processes

10.1 Introduction

An alkylation process employs isobutane (iC_4) and low molecular weight alkenes primarily a mixture of propylene (C_3H_6) and butylene (C_4H_8) into an alkylate, a branched-chain paraffinic fuel. The process occurs under conditions selected to maximize the alkylate yield and quality in the presence of a strong-acting acid such as sulfuric acid (H_2SO_4) and hydrofluoric acid (HF) as catalyst. Depending upon the acid used, the unit takes the name as Sulfuric Acid Alkylation Unit (SAAU) or hydrofluoric Acid Alkylation Unit (HFAU). The alkylate is composed of a mixture of high-octane, branched-chain paraffinic hydrocarbons (mostly isoheptane and isooctane) having a low Reid vapor pressure. It is premium gasoline blending stocks for cleaner burning gasoline because it possesses excellent antiknock properties and high octane because of its high content of highly branched paraffins. The octane number of the alkylate depends mainly upon the type of alkenes and operating conditions. For example, isooctane results from combining butene with isobutane and has an octane rating of 100. Additionally, alkylate contains neither benzene nor aromatics and

very little sulfur. Therefore, the blending of alkylate into the gasoline pool helps lower the benzene, aromatics and sulfur levels through dilution.

Generally, crude oil contains 10–40% of hydrocarbon constituent in the gasoline range; refineries normally employ a fluid catalytic cracking unit (FCC) process to convert high molecular weight hydrocarbons into smaller and more volatile compounds. These are then converted into liquid gasoline-size hydrocarbons. Alkylation processes convert low molecular weight alkenes and iso-paraffins molecules into larger iso-paraffins with a high octane number.

The alkylation technology was developed in the 1930s primarily to fulfil the demand for high-octane aviation fuel. In the 1950s and 1960s, the U.S. automobile industry started producing higher compression engines that require higher octane/gasoline and the refiners' interest in alkylation shifted from the production of aviation fuel to the use of alkylate as a blend-stock in premium motor fuel. The demand for alkylate through the 1970s and 1980s continued to grow, as alkylate replaced the lead in gasoline by providing some of the octane lost when alkylate lead addition to gasoline was no longer permitted. Furthermore, the

demand increased for higher octane premium gasoline, thereby requiring the increase in demand for alkylation as a high-octane blendstock.

The technologies for sulfuric acid and hydrofluoric acid have each held 50% of the market share for alkylation. However in late 1980s, several hydrofluoric acid (HF) releases as well as industry testing showed that HF acid forms a relatively long-lasting aerosol when released into the atmosphere, with large potential to form a toxic cloud that could extend beyond the boundary of the refinery. These events resulted in the evaluation of the merits of both hydrofluoric acid alkylation unit (HFAU) and sulfuric acid alkylation unit (SAAU) technologies, and resulted in the removal of HF alkylation making sulfuric acid as the catalyst of choice. The product of the unit, which is the alkylate, is composed of a mixture of high-octane branched chain paraffinic hydrocarbons (mostly isoheptane and isooctane). Alkylate is a premium gasoline blending stock because it has exceptional antiknock properties and is clean burning. The octane number of the alkylate depends mainly upon the kind of alkenes used and the operating conditions. For example, isooctane results from combining isobutane and butylene in the presence of H_2SO_4 as catalyst resulting in an octane number of 100.

The *Oil & Gas Journal* of 1st January 2016 states that the worldwide installed alkylation capacity was 2,056,035 barrels per day and since 2009 over 90% of the additional installed capacity used Sulfuric Acid Alkylation unit (SAAU) technology. Furthermore, there were 121 refineries in the U.S. that operated with an overall capacity of 18,096,987 barrels per day, of which 1,138,460 barrels per day were of alkylation capacity.

Alkylate is a component of choice in gasoline because it is free of aromatics and olefins and low RVP, which reduces the possibility to blend butane. For safety reasons, SAAU is the prevalent current technology of choice. The two major licensors of the HFAU process are UOP and Conoco Phillips, which have been combined as UOP under the ownership of Honeywell. The main technology used for the SAAU is the STRATCO process licensed by DuPont, followed by the EMRE technology owned by ExxonMobil. In the last ten years, 85% of the SAAU capacity added worldwide has utilized STRATCO DuPont technology.

The U.S. 1990 Clean Air Act Amendments required reformulated cleaner burning gasoline for the most polluted areas in the country. Through the 1990s, methyl tertiary butyl ether (MTBE) was the preferred oxygenate of petroleum refiners, with nearly 90% of

the nation's cleaner burning gasoline using MTBE as the prime pollution fighting oxygenate. However, the health effects of MTBE were largely unknown, as it leaked into underground fuel tanks, ground water, lakes and reservoirs.

MTBE has a blending octane in the range of 106–110 and has effectively been phased out of the gasoline pool. While there are other ethers available to meet oxygenate requirements (EPA has approved TAME, ETBE and TBA for blending), there is concern over the toxicology of these oxygenates. Nominal quantities of these ethers were being produced, but not nearly enough to replace MTBE. These components are also partially soluble in water and are likely to contaminate groundwater as well. Ethanol (C_2H_5OH) has a blending octane of ~ 133 and an oxygen content of ~ 35 wt% compared to 18 wt% of MTBE.

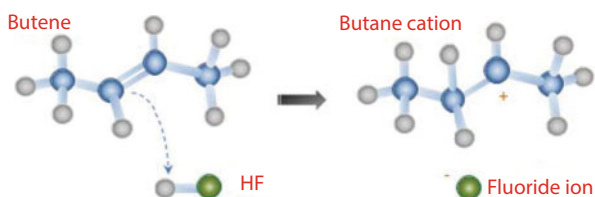
10.2 Chemistry of Alkylation

The alkylation process involves a bimolecular nucleophilic substitution reaction where an olefin molecule reacts with an isobutane molecule to form branched chain paraffin in the presence of an acid as a catalyst. The alky unit receives olefin feed from upstream cracking such as the FCC and Coker units. Olefins are unstable molecules because of the double bond created by an extra set of electrons. This reactivity sets the stage for the alkylation reaction as follows [1]:

Step 1: Cation formation

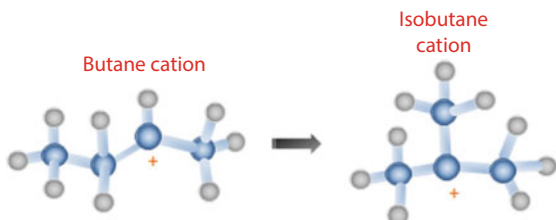
In the HF alkylation unit, the olefin molecule reacts with the HF acid catalyst.

- Fluorine is a very electronegative atom and dissociates from hydrogen easily.
- The olefin double bond attracts the hydrogen atom from the HF acid molecule.
- The olefin molecule becomes a cation (positively charged molecule) as it bonds to hydrogen.
- A fluoride ion is formed when the hydrogen is released from the HF molecule.



Step 2: Cation Rearrangement

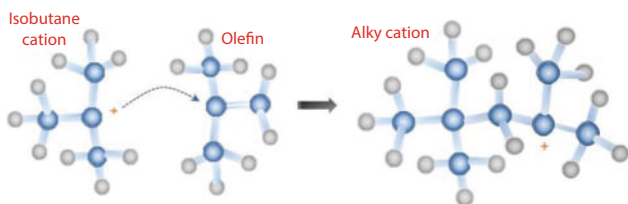
Before combining with an olefin molecule, the butane cation rearranges itself to form an isobutane cation. This occurs through a hydride and a methyl shift.



Step 3: Pairing

The isobutane cation then reacts with another olefin molecule to create a larger cation

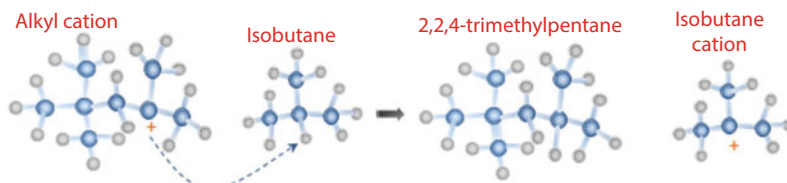
- The isobutane cation is electron deficient so seeks out an olefin molecule.
- The olefin molecule has an extra electron pair that it can donate to the isobutane cation.



Step 4: Chain Termination

The alkyl cation created in step 3 must now absorb a hydrogen atom from an isobutane molecule to successfully complete the alkylation process.

- Isobutane is very essential in the alkylation reaction as it transfers hydrogen very readily. This occurs because the isobutane has tertiary hydrogen, thus driving the importance of monitoring the alkyl isobutane/olefin ratio.
- An eight carbon alkylate molecule (2, 2, 4 trimethylpentane) is created as a final product.
- An isobutane cation is also created, therefore propagating the next alkylation reaction.

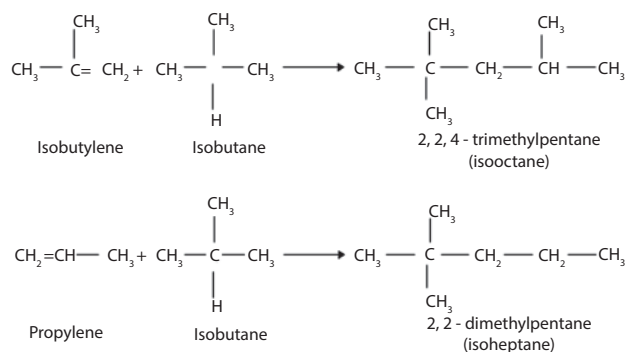


Step 5: Catalyst recovery

Since the role of HF is to act as a catalyst, the fluoride ions eventually recombine with the hydrogen ions to form a HF molecule.



The principal reactions that occur in alkylation are the combinations of olefins with isoparaffins as follows:



A significant reaction in propylene alkylation is the combination of propylene with isobutane to form propane plus isobutylene. The isobutylene further reacts with more isobutane to form 2, 2, 4 trimethylpentane (isooctane). The first step involves the formation of propane and is referred to as hydrogen transfer reaction. Studies have been carried out on catalyst modifiers to promote this step because it produces a higher octane alkylate than is obtained by the formation of isooheptanes.

A common set of reactions products are defined for H_2SO_4 and HF processes. While the isomer distribution differs, the same isoparaffin compounds are produced. All reactants produce isopentane and isooctane isomers, indicating that many side reactions are occurring in addition to the expected primary reactions:

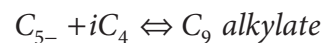
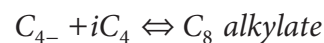
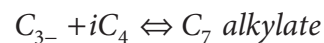


Table 10.1 Reaction Products from Alkylation of Olefins with Isobutane.

Reactor feed	Reactor product	Carbon number
C3-	propane	3
C3-, iC4-, 1 - C4-, cis2-C4-, tr2-C4-	isobutane	4
C3-, iC4-, 1 - C4-, cis2-C4-, tr2-C4-, C5-	isopentane	5
C3-, iC4-, 1 - C4-, cis2-C4-, tr2-C4-, C5-	2-3 dimethylbutane	6
C3-, iC4-, 1 - C4-, cis2-C4-, tr2-C4-, C5-	2-3 dimethylpentane	7
C3-, iC4-, 1 - C4-, cis2-C4-, tr2-C4-, C5-	2-4 dimethylpentane	7
C3-, iC4-, 1 - C4-, cis2-C4-, tr2-C4-, C5-	2 2 4 trimethylpentane	8
C3-, iC4-, 1 - C4-, cis2-C4-, tr2-C4-, C5-	2 3 3 trimethylpentane	8
C3-, iC4-, 1 - C4-, cis2-C4-, tr2-C4-, C5-	2 3 4 trimethylpentane	8
C3-, iC4-, 1 - C4-, cis2-C4-, tr2-C4-, C5-	2-3 dimethylhexane	8
C3-, iC4-, 1 - C4-, cis2-C4-, tr2-C4-, C5-	2-4 dimethylhexane	8
C3-, iC4-, 1 - C4-, cis2-C4-, tr2-C4-, C5-	2 2 5 trimethylhexane	9
C3-, iC4-, 1 - C4-, cis2-C4-, tr2-C4-, C5-	C10 paraffins	10
C3-, iC4-, 1 - C4-, cis2-C4-, tr2-C4-, C5-	C11 paraffins	11
C3-, iC4-, 1 - C4-, cis2-C4-, tr2-C4-, C5-	C12 paraffins	12
C3-, iC4-, 1 - C4-, cis2-C4-, tr2-C4-, C5-	C13+ paraffins	13+

Note: HF alkylation always produces propane; H₂SO₄ alkylation production of propane depends on operating conditions.

The alkylation reactions have been thoroughly studied, and the composition of the alkylate produced from the various light olefins have been published in the literature. Although there are some variations in the product compositions that are associated to operating conditions, the various paraffin isomers in the alkylate products are known. There is also some variation in the isomer distribution of the alkylate produced from a given olefin for H₂SO₄ and HF processes. However, the same paraffin isomers are present for these acids. Table 10.1 shows reactions products from alkylation of olefins with isobutane [9].

10.3 Catalysts

Aluminum chloride (AlCl₃) catalyst was used in the 1930s for the alkylation of isoparaffins with olefins, but was later replaced by hydrofluoric and sulfuric acids. Concentrated hydrofluoric and sulfuric acids are the only catalysts used for the production of high-octane alkylate gasoline; other catalysts are used to produce ethylbenzene, cumene and long chain (C₁₂ - C₁₆) alkylate benzenes. The desirable reactions are the formation of C₈ carbonium ions and the formation of alkylate. The main undesirable reaction is

polymerization of olefins. Strong acids can catalyze the alkylation reaction as weaker acids result in polymerization. Therefore the acid strengths must be above 88% by weight H₂SO₄ or HF in order to prevent excessive polymerization. Sulfuric acid containing free sulfur trioxide (SO₃) also causes undesired side reactions, and concentrations greater than 99.3% H₂SO₄ are not used [2]. A concentration less than 88% requires that the acid is removed and replaced with stronger acid. In hydrofluoric acid units, the acid removed is redistilled and the polymerization products removed as thick, dark acid-soluble oil (ASO). The concentration HF is recycled in the unit, and the net consumption is ~ 0.3 lb per barrel of alkylate produced. H₂SO₄ is also removed and regenerated in a sulfuric acid plant, which is not a part of the alkylation unit. Table 10.2 provides conventional and improved catalyst for gasoline production.

Studies have been conducted in the area of a solid catalyst for alkylation and numerous patents for different catalysts, catalyst supports and processes. Lewis acids will catalyze the alkylation reaction (e.g., alkylation of isobutane with olefins using aluminum chloride promoted with hydrochloric acid). The hazards and costs associated with using and regenerating corrosive liquid acids are eliminated with solid acid catalyst (SAC) alkylation. SAC can produce high-quality

alkylate without drawbacks of existing H_2SO_4 and HF acid liquid technologies. Several of the current preferred solid catalysts use a salt of HF, either boron trifluoride (BF_3) or antimony pentafluoride (SbF_5). However, since every alkylation process produces heavy polymers, solid catalysts have the tendency to foul readily. Thus, solid catalyst processes have to overcome catalyst life and regeneration. Figure 10.1 shows a block diagram of solid catalyst process.

However, the economic viability of SAC against H_2SO_4 and HF acid catalysts is adequate catalyst stability as SAC deactivated on the order of minutes to hours. Table 10.3 provides operating parameters of the SAC process. Catalyst regeneration requires 6–18 hours. The catalyst service life is the most critical design parameter, and the service life is controlled by isoparaffin to olefin ratio and olefin hourly space velocity.

The first commercialization of alkylation process using a solid catalyst occurred in 2015 at the Wonfull

refinery in China. The unit uses the AlkyClean[®] process technology, developed jointly by CB & I, Albemarle Corporation and Neste Oil. The start-up of the unit has a capacity of 2,700 barrels per stream day of alkylate production. The AlkyClean process with Albemarle's Alky Star catalyst produces high-quality alkylate product without the use of liquid acid catalysts in the alkylate manufacturing production. AlkyClean process significantly improves the safety of refinery alkylation over conventional liquid-based processes. It reduces the potential hazards associated with transportation of corrosive H_2SO_4 and HF acids. Table 10.4 shows the cost of alkylation involving H_2SO_4 and SAC processes.

10.4 Process Variables

The principal variables that influence the product quality and operating costs of the alkylation unit are:

Table 10.2 Summary of conventional and improved catalysts for gasoline production.

Process	Objective	Conventional/old generation catalysts	Improved new generation catalysts	Benefits of improved catalysts
Alkylation	Production of branched alkanes for gasoline octane enhancement	H_2SO_4 HF	Supported BF_3 Modified SbF_5 Supported liquid-acid- catalysts.	Less corrosive Safe handling Fewer environmental problems Continuous operation.
Isomerization	Conversion of C_5 / C_6 alkane streams into high-octane branched isomers	$\text{Pt}/\text{Al}_2\text{O}_3$ $\text{Pt}/\text{SiO}_2 - \text{Al}_2\text{O}_3$ Modernito (zeolite)	Solid super acid catalysts (e.g. suffocated zirconia).	Low- temperature (thermodynamically favorable) operation Increased conversion, less cracking.

Source (Abasi-Halabi, Stanislaus, A., Qabazard, H., *Hydrocarbon Processing*, p 45, Feb 1997)

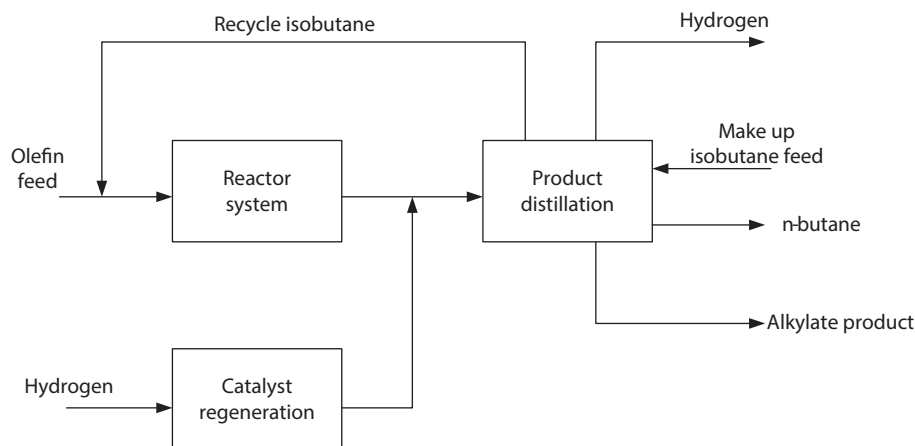


Figure 10.1 Typical solid catalyst (SAC) process.

Table 10.3 Typical operating parameters for the SAC process.

Reaction temperature, °C	50–100
Reaction pressure, bar	20
Feed isobutane/olefin ratio (mol/mol)	10–15
Olefin space velocity	0.2–0.5

Table 10.4 Economics of conventional and new alkylation processes.

Parameter	Sulfuric acid process	SAC process
Capital investment (\$/bpsd)	36,000	2,600
Yield vol/vol olefin		
Alkylate yield	1.78	1.83
Isobutane consumption	1.17	1.21
Utilities (per bbl of alkylate)		
Steam 60 psig (lb)	200	237
Power (kWh)	10.5	3.5
Water cooling	2.2	0.227
Sulfuric acid (lb)	20	
NaOH, 100% (lb)	0.1	-
Hydrogen (lb)		0.15

Source: Mukherjee and Nehlsen, *Hydrocarbon Processing*, 2006.

Isobutane concentration

This is generally expressed in terms of isobutane/olefin (I/O) ratio. High isobutane/olefin ratios increase the octane number and yield, and reduce side reactions and acid consumption. Low (I/O) ratios increase the formation of olefin polymerization that results in lower octane. Polymerization reactions can form acid soluble oils, resulting in higher acid consumption.

Reaction temperature

This has a greater effect in sulfuric acid unit than in hydrofluoric acid unit. Low temperatures slow the settling rate of the acid from the alkylate. In sulfuric acid alkylation, low temperatures cause the acid viscosity to become so great that good mixing of the reactants and separation of the emulsion is difficult. At temperatures above 70 °F (21 °C), polymerization of the olefins becomes significant and yields are decreased. The normal sulfuric acid reactor temperature is 40–50 °F (5–10 °C) with a maximum of 70 °F (21 °C) and a minimum of 30 °F (-1 °C). In hydrofluoric acid alkylation,

increasing the reactor temperature from 60–125 °F (16–52 °C) degrades the alkylate quality about three octane numbers [2].

Acid strength

This has varying effects on alkylate quality depending on the effectiveness of mixing in the reactor and the water content of the acid. High acid concentration must be maintained in order to minimize polymerization and red oil production. When concentration is too low, catalyst activity is reduced and polymerization is increased to such that is difficult to maintain the acid strength. This condition is referred to as acid runaway.

In sulfuric acid alkylation, studies have shown that both butylenes and amylenes can be sent to a lower acid concentration without entering into a runaway condition. While the economics of alkylating butylenes and amylenes will benefit from lowering the acid strength, the acid consumption of amylenes has a greater response than that of butylenes. Furthermore, the expected decrease in octane of alkylates produced at lower acid concentrations is less for amylenes than butylenes. The best quality and highest yields are achieved with acid strengths of 93 to 95% by weight of acid, 1 to 2% water and the remainder hydrocarbon diluents. The water concentration in the acid lowers its catalytic activity about three to five times as much as hydrocarbon diluents, thus an 88% acid containing 5% water is a much less effective catalyst than the same strength acid containing 2% water. The poorer the mixing in a reactor, the higher the acid strength required to keep acid dilution down [2]. Increasing acid strength from 89–93% by weight increases alkylate quality by one to two octane numbers.

In hydrofluoric acid alkylation, the highest octane number alkylate is reached in the 86–90% by weight acid range. However, commercial operations have acid concentrations between 83–92% hydrofluoric acid and contain less than 1% water.

Olefin space velocity

This is defined as the volume of olefin charged per hour divided by the volume of acid in the reactor. Lowering the olefin space velocity reduces the amount of high-boiling hydrocarbons produced, increases the product octane, and lowers acid consumption. Olefin space velocity is a way of expressing reaction time and another is by using contact time. This is defined as the residence time of the fresh feed and externally recycled isobutane to the reactor. Contact time for sulfuric acid

alkylation ranges from 5–40 min and for hydrofluoric acid alkylation from 5–25 min [3].

Mixing

Mixing is an important variable in the alkylation reactor, and especially in sulfuric acid alkylation unit. This is because the alkylation reaction depends on the emulsion of the hydrocarbon into sulfuric acid. The best quality alkylate is produced with the lowest acid consumption when [6]:

- The “local” isobutane/olefin ratio in the mixing zone is maximized by premixing the olefin and isobutane feeds.
- The feed is rapidly dispersed into the acid/hydrocarbon emulsion.
- Intense mixing gives the emulsion a high interfacial area.

Figure 10.2 illustrates the key variables that influence the design and operation of an alkylation process. Table 10.5 shows typical alkylation operating conditions and Table 10.6 shows theoretical yields of alkylates and isobutane requirements based on olefin reacted.

10.5 Alkylation Feedstocks

The feedstocks used in the alkylation process are olefins and isobutane. These are obtained from the catalytic

Table 10.5 Range of Operating variables in alkylation [6].

	HF	H ₂ SO ₄
Isobutane concentrations Vol% in reaction zone	30–80	40–80
External ratio in olefins	3–12	3–12
Internal ratio in olefins	–	0.1–0.6
Olefin concentration Total HC contact time, min	8–20	20–30
Olefin space velocity, v/hr/v	–	0.1–0.6
Reactor temperature		
°F	60–115	35–60
°C	16–46	2–16
Reactor acid conc., wt%	80–95	88–95
Acid in emulsion, vol%	25–80	40–60

Table 10.6 Theoretical Yields and Isobutane Requirements Based on Olefin Reacting [6].

	Alkylate vol%	Isobutane vol%
Ethylene	188	139
Propene	181	128
Butene (mixed)	172	112
Pentenes (mixed)	165	96

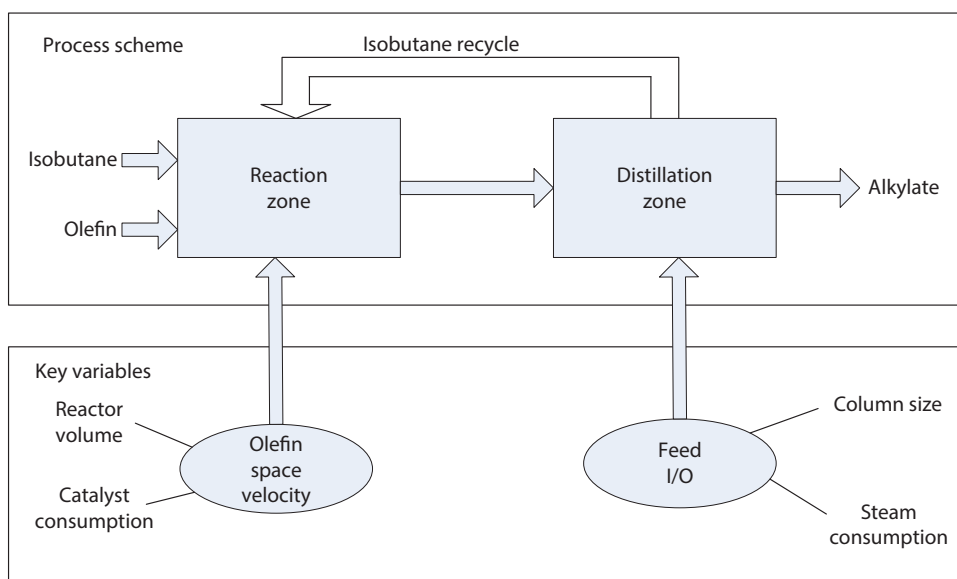


Figure 10.2 Key variables that influence the design and operation of an alkylation process (Source: Mukherjee and Nehlsen, *Hydrocarbon Processing* [4]).

cracking and coking operations and from the reformer unit. Propylene (C_3H_6) and butylenes (C_4H_8) are the most common olefins used, but pentenes (C_5H_{10}) (amylenes) are included in some cases. Some refineries include pentenes in alkylation unit feed to lower the FCC gasoline vapor pressure and reduce the bromine number in the final gasoline blend. The alkylation of pentenes is considered as a way to reduce the C_5 olefin content of final gasoline blends and reduces its effects on ozone production and visual pollution in the atmosphere.

Olefins are produced by the dehydrogenation of paraffins, and isobutane is cracked commercially to provide feed to the alkylation unit. Hydrocrackers and catalytic crackers produce a large amount of the isobutane used in the alkylation process, but it is also obtained from catalytic reformers, crude distillation and natural-gas processing. There are cases where normal butane is isomerized to produce additional isobutane for the alkylation unit.

10.6 Alkylation Products

The products leaving the alkylation unit are the propane, normal butane and the alkylate streams. The propane and normal butane enter with the saturated and unsaturated feed streams as well as a small quantity of tar produced by polymerization reactions. The product streams leaving the alkylation unit are [6]:

1. LPG-grade propane liquid (C_3H_8)
2. Normal butane liquid (nC_4H_{10})
3. C_{5+} alkylate
4. Tar

10.7 Sulfuric Acid Alkylation Process

Sulfuric acid alkylation unit (SAAU) consists of the following steps:

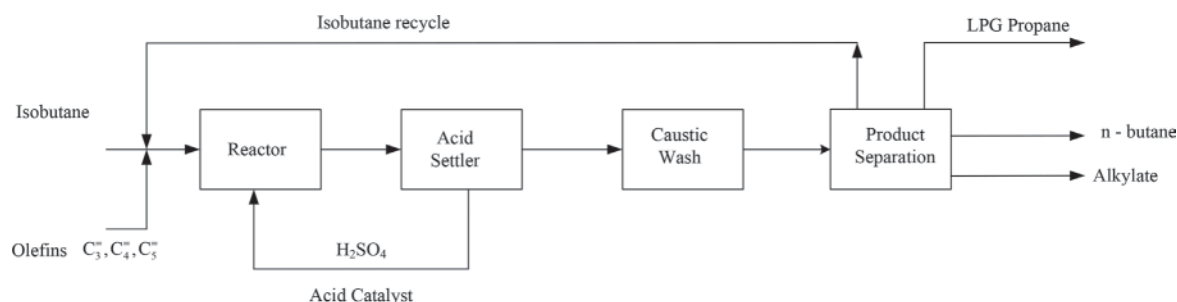


Figure 10.3 Block diagram of sulfuric acid (H_2SO_4) alkylation process.

- A reaction zone where an emulsion and hydrocarbons with acid recycled to the alkylation reaction takes place.
- A settling zone for separation of acid and hydrocarbons with acid recycled to the reactor and hydrocarbons routed to the separation zone.
- An unreacted isobutane/n-butane and alkylate separation zone consisting of the stabilization zone.

A block diagram for the alkylation process is shown in Figure 10.3. An olefin-rich feed stream is combined with isobutane and reacted over an acidic catalyst to produce an alkylated gasoline product (alkylate). A large recycled isobutane is combined with the fresh feed to the reactor to minimize formation of undesirable products that contaminate the catalyst. The product mixture is separated from the acid catalyst, and the catalyst is circulated back to the reactor. The product mixture is separated and a large stream high in isobutane is recycled back to dilute the fresh feedstock. Sufficient fresh isobutane feed must be added to the process to meet the chemical consumption in the alkylation reactions and the losses of isobutane from the system into the fractionated products, i.e., propane, normal butane and alkylate.

Process details

The process of sulfuric acid alkylation involves alkylation of feedstocks (propylene, butylenes, amylene and fresh isobutane) in stirred auto-refrigerated cascade type sulfuric acid alkylation reactor, which is divided into zones, and concentrated sulfuric acid (85–95%) is used as the catalyst. Use of concentrated sulfuric acid minimizes the corrosion problems which are more severe in dilute condition.

The reaction is exothermic and reaction heat is removed by use of an auto-refrigeration system. The reactor effluent is separated into hydrocarbon and acid phases in the settler. The settled sulfuric acid is recycled to the reactor, and the hydrocarbon phase from the alkylator is washed with caustic and sent to the deisobutanizer for the separation of alkylate and isobutane. The isobutane is then recycled. Figure 10.4 illustrates a conventional sulfuric alkylation process, and Table 10.7 provides the description of common commercial alkylation processes.

The operating variables are catalyst composition, reaction temperature, isobutane/olefin molar ratio and stirring power of H_2SO_4 units. Isobutane/olefin ratio is one of the most important parameters in alkylation, which controls the catalyst consumption and yield of the product. Reaction temperature range is around 0–10 °C. Although temperature below 0 °C results in higher octane, acids viscosity becomes viscous and poses an operational problem.

Acid consumption is dependent on olefin feedstock and impurities in the feedstock. However, significant improvement has been made in the sulfuric acid alkylation process to reduce the consumption of the acid and to improve the alkylate quality.

There are two common reactor designs for sulfuric acid alkylation process: auto-refrigeration systems and effluent refrigeration systems. In auto-refrigeration systems, the reaction mixture is cooled by allowing some of the isobutane to vaporize and boil out of the reaction mixture. These vapors are compressed,

cooled, depropanized if required, chilled and returned to the reactor (Figure 10.5). In the effluent refrigeration process, a large stirred tank reactor vessel is used to contact and circulate the reaction mixture and the acid catalyst. The reaction mixture is cooled by a tube bundle in the reactor in which the reactor effluent vapors are allowed to expand and cool (Figure 10.6). The major differences between the auto-refrigeration and effluent refrigeration processes are in the reactor designs and the point in the process at which propane and isobutane are evaporated to induce cooling and provide the process refrigeration required.

The auto-refrigeration process uses a multistage cascade reactor with mixers in each stage to emulsify the hydrocarbon-acid mixture. Olefin feed or a mixture of olefin feed and isobutane feed is introduced to obtain sufficient contacting of the acid catalyst with the hydrocarbon reactants to obtain good reaction selectivity. The reaction is held at a pressure of approximately 10 psig (69 kPag) in order to maintain the temperature at about 40 °F (5 °C). In the Stratco or similar type of reactor system, the pressure is kept high enough [45–60 psig (310–420 kPag)] to prevent vaporization of the hydrocarbons [5].

10.8 HF Alkylation

Hydrofluoric acid alkylation involves alkylation of light olefins (propylene, butylenes and amylenes) with isobutane in the presence of HF as catalyst resulting

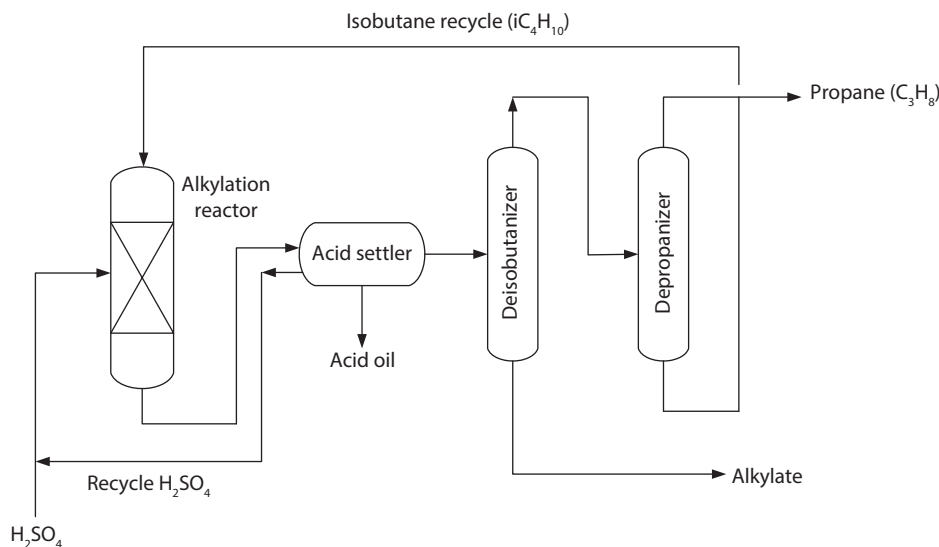


Figure 10.4 Conventional sulfuric acid alkylation process.

Table 10.7 Common commercial alkylation processes.

Alkylation process	Description
Exxon alkylation	<p>The process involves alkylation of propylene, butylenes and perylene with isobutane in the presence of sulfuric acid catalyst using auto refrigeration method. Auto refrigeration alkylation results in low maintenance, low operating cost and high service factor with trouble-free operation. Products: A low sensitivity, highly iso, low RVP, high-octane gasoline blendstock paraffinic. Alkylate quality 96 RON/94 MON alkylate yield 1.78 bbl C₅₊/bbl butylenes feed. Isobutane required: 1.17 bbl/bbl butylenes feed.</p>
Stratco process	<p>The process involves reaction of propylene, butylenes and amylenes with isobutane in the presence of strong sulfuric acid using the effluent refrigerated alkylation process to make high branched chain hydrocarbons. The Stratco contactor reactor (Figure 10.6) forms the heart of the alkylation technology. It is a horizontal pressure vessel containing an inner circulation tube, a tube bundle to remove the heat of reaction, and a mixing impeller. The hydrocarbon feed and sulfuric acid enter on the suction side of the impeller inside the circulation tube. As the feeds pass across the impeller, an emulsion of hydrocarbon and acid is formed. The emulsion in the contactor reactor is continuously circulated at very high rates. The superior mixing and high internal circulation of the contactor reactor minimize the temperature difference between any two points in the reaction zone to within 1 °F (0.6 °C). This reduces the possibility of localized hot spots that lead to degrade alkylate product and increased chances for corrosion.</p> <p>Furthermore, the intense mixing also provides uniform distribution of the hydrocarbons in the acid emulsion. This prevents localized areas of non-optimum isobutane/olefin ratio and acid/olefin ratio, both of which promote olefin polymerization reactions.</p> <p>The Stratco reactor allows minimum contact time to reduce the side reactions that may lead to formation of red oils. Product: Total debutanizer alkylate RON: 92–96, MON: 90–94. The effluent refrigeration process uses a single-stage reactor in which the temperature is maintained by cooling coils. The reactor contains an impeller that emulsifies the acid-hydrocarbon mixture and recirculates in the reactor. The average residence time in the reactor is on the order of 20–25 min. Acid strength: The acid cascade system used by Stratco provides a higher average acid strength in the reaction zone than can usually be accomplished with large auto-refrigerated reactors. The higher average acid strength results in higher alkylate octane with reduced acid consumption.</p>
ConocoPhillips process (ReVAP process)	<p>Alkylation of propylene, butylenes, pentenes and isobutane to high quality motor fuel using HF catalyst. Product: Motor or aviation fuel blending stock. The reactions produce a variety of products, primarily C₈ branched paraffins, with lesser amounts of C₇ and C₉ branched paraffins and small amounts of lighter and heavier paraffins. For optimum operation, the following feedstock contaminant levels are recommended:</p> <ul style="list-style-type: none"> • Sulfur – 20 wt ppm maximum • Water – 20 wt ppm maximum • Butadiene – 3000 wt ppm maximum • Oxygenates (MTBE, dimethyl ether, etc.) – 30 wt ppm maximum. <p>An alkylation unit that operates with feed contaminant at higher than the levels indicated above, but the adverse consequences are higher acid consumption, higher production of unwanted by-products and possible lower octane number of the alkylate product. ConocoPhillips employs a technology referred to as Hydrisom process involving hydroisomerization reaction that reduces butadiene (and pentadienes) to very low levels and isomerizes 1 – butene to cis – and trans – 2 butene. The trans – 2 isomers give higher – octane alkylate in the HF Alkylation process [8]. Typical feed and alkylate specification are given in Table 10.8.</p>

(Continued)

Table 10.7 Cont.

Alkylation process	Description
UOP HF alkylation process	Alkylation of isobutane with light olefins (propylene, butylenes and amylenes to produce a branched chain paraffinic fuel) using the hydrofluoric acid catalyst. In this process, only isoparaffins with tertiary carbon atoms, such as isobutane or isopentane react with the olefins. The alkylation process is characterized by simple addition as well as numerous side reactions. Primary reaction products are the isomeric paraffins containing carbon atoms that are the sum of the isobutane and the corresponding olefin. However, secondary reactions such as hydrogen transfer, polymerization, isomerization and destructive alkylation also occur, resulting in the formation of secondary products both lighter and heavier than the primary products. There are more than 100 commercial processes.
UOP alkylene™	<p>UOP alkylene process is based on a solid catalyst (HAL – 100) for alkylation of light olefins and isobutane to form a complex mixture of isoalkanes which are highly branched trimethylpentanes (TMP) that have high octane blend values of approximately 100. Dimethyl hexanes (DMH) have lower octane blend values and are present in the alkylate at varying levels.</p> <p>The novel HAL – 100 catalyst has high alkylation activity and long catalyst stability and easily regenerates without a high-temperature carbon burn. Selectivity of the HAL – 100 is excellent, and product quality is comparable to that of the product obtained from liquid acid technologies. Alkylation conditions that favor the desired high-octane trimethylpentane include low process temperature, high localized isobutane/olefin ratios, and short contact time between the reactant and catalyst. Furthermore, the alkylene process is designed to promote quick intimate contact of short duration between hydrocarbon and catalyst for octane product, high yield and efficient separation of alkylate from the catalyst to minimize undesirable secondary reactions. Process conditions are mild and do not require expensive metallurgy. The key operating variables are reactor temperature, isobutene/olefin ratio, contact time, and catalyst/olefin ratio.</p>
Lummus AlkyClean Process	The AlkyClean process employs a zeolite catalyst coupled with a novel reactor processing to produce a high-quality alkylate product. The process consists of four main sections: feedstock pretreatment, reactor system, catalyst regeneration and product distillation. An olefin feed is preheated and fed with the isobutane, which is recycled to the reactor. The reactor operates at 122–94 °F (50–90 °C) in liquid phase conditions (Figure 10.7). Multiple reactors are employed to allow for the catalyst regeneration cycle. During regeneration, olefin addition is stopped and hydrogen is added to achieve a low reactor concentration of dissolved hydrogen while maintaining liquid phase alkylation reaction conditions. This minimizes energy consumption during the switching of the operation. The swing reactor coupled with long catalyst life enables the refiner to work without the need of taking the reactor off-line for moderate temperature regeneration that restores the catalyst activity completely.

(Source: *Refining Processes*, 1998; *Refining Processes*, 2008; Graves 2004; Roeseler, 2004; Himes *et al.*, 2003.)

 Table 10.8 RON and MON of alkylates from various olefins in HF and H₂SO₄ alkylations.

	1 - butene		2- butene		Isobutene		Propene		Pentene	
	HF	H ₂ SO ₄	HF	H ₂ SO ₄	HF	H ₂ SO ₄	HF	H ₂ SO ₄	HF	H ₂ SO ₄
RON	94–95	98–99.6	97–98	98–99	94–95	90–91	91–93	89–92	91–92	92–93
MON	91–92	94–95	93–94	94–95	90–91	88–89	89–91	88–90	90	91

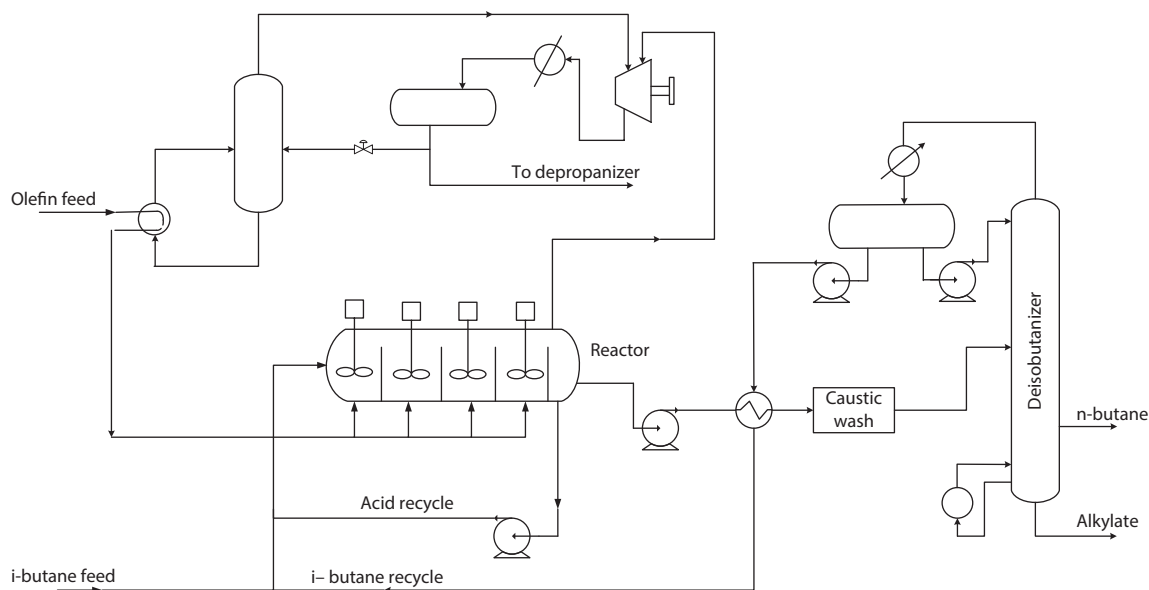


Figure 10.5 Auto-refrigeration sulfuric acid alkylation unit.

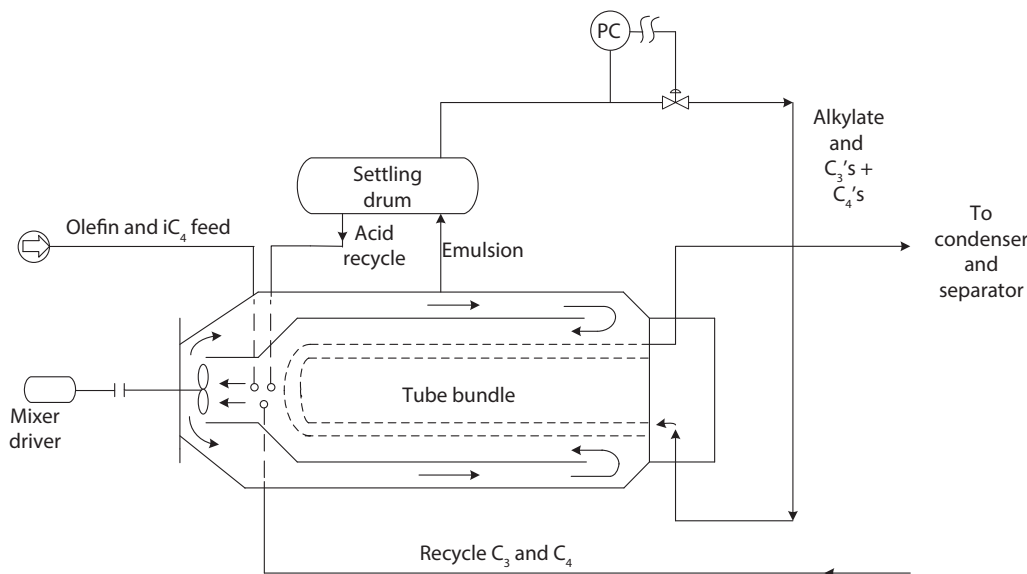


Figure 10.6 Stratco contactor.

in formation of branched-chain paraffinic fuel having high-octane blending stock.

Process details

The olefin and isobutane feed along with recycle isobutene is charged to the alkylator. HF alkylation units do not have mechanical stirring system due to low viscosity of HF. The reaction product from the alkylator containing hydrocarbon phase and HF phase are separated

in the acid settler to hydrocarbon phase containing the alkylate, other hydrocarbons and the acid phase. The hydrocarbon phase is fractionated and isobutene is recycled to the reactor and the bottom product containing the alkylate is washed with potassium hydroxide (KOH) and sent to the gasoline pool. The light end from the isostripper is separated from HF in HF stripper. When the feedstock contains propane, then an additional depropanizer is used to separate propane from isobutene which is then treated by alumina to

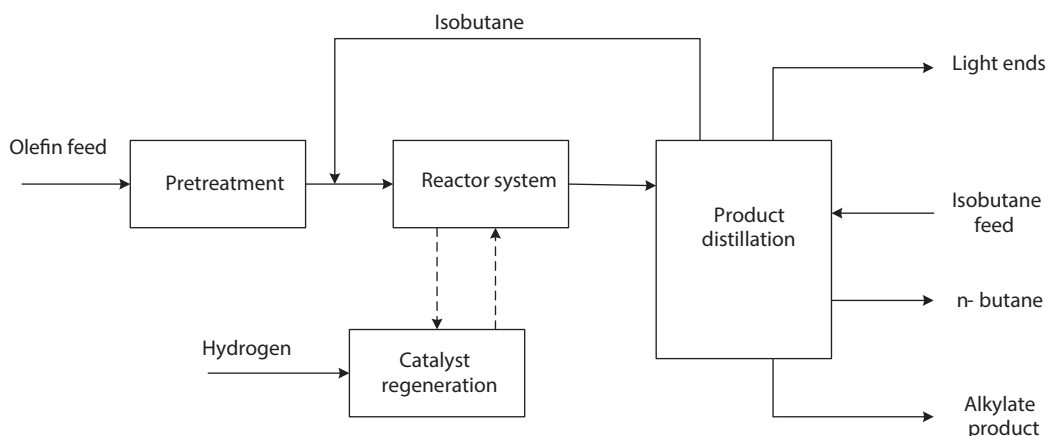


Figure 10.7 A block diagram of AlkyClean process.

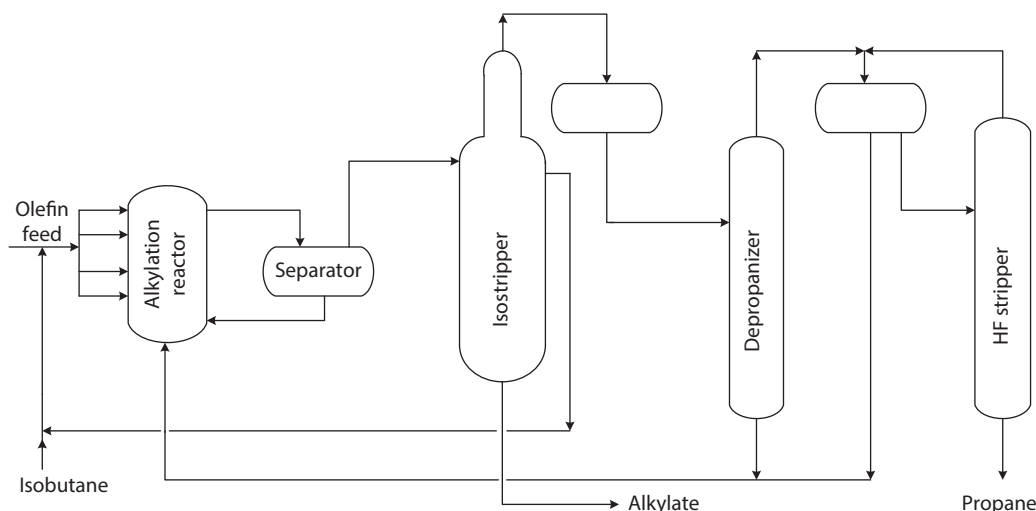


Figure 10.8 UOP HF alkylation process (Feed: butene).

remove traces of HF. Figure 10.8 shows a typical HF process flow diagram and Table 10.9 illustrates typical yield of the alkylate from butylenes and propylene-butylene mix. Hydrotreatment of HF alkylation feed significantly improves the performance of alkylation by hydrogenation of polyunsaturated, conversion of butadiene into butenes, conversion of 1 - butene to 2 - butene using alumina supported catalyst using nickel and palladium. Figure 10.9 shows a process flow diagram of the alkylation unit using UOP solid phosphoric acid and Figure 10.10 shows a photograph of an alkylation unit.

Quality Factor

A quality factor is a term used to indicate the relative quality of alkylate measured by research octane

number, aviation blending octane number or superior blending index number. This is expressed by:

$$F = \frac{(iC_4/O)(iC_4)}{SV}$$

where

iC_4/O = isobutane/olefin volume ratio

iC_4 = volume fraction isobutene in reactor effluent

SV = Olefin space velocity, volume/reactor volume/hour

10.9 Kinetics and Thermodynamics of Alkylation

Alkylation is carried out in the liquid phase, the gas phase or in a mixed gas-liquid system. Considering

the simple liquid phase reaction of isobutene (A) and isobutane (B) resulting in iso-octane (C) and expressed by an equilibrium reaction:



Table 10.9 Typical stabilized alkylate yield from butylene and propylene-butylene mix.

Feed type	Butylene	Propylene-butylene mix
Propylene	0.8	24.6
Propane	1.5	12.5
Butylene	47.0	30.3
i - butane	33.8	21.8
n - butane	14.7	9.5
i - pentane	2.2	1.3
Alkylate, stabilized		
Gravity (°API)	70.1	71.1
RVP (psi)	6-7	6-7
ASTM 10% (°F)	185	170
ASTM 90% (°F)	236	253
RONC	96.0	93.5
Per bbl olefin converted		
i - butane consume (bbl)	1.139	1.175
Alkylate produced (bbl)	1.780	1.755

Installation: 107 units licensed worldwide
 Source: *Hydrocarbon Process*, p 55, Nov. 1998.

If y is considered as the degree of conversion, m_{AO} and m_{BO} are the number of moles of A and B in the initial mixture respectively, and $\delta = m_{BO}/m_{AO}$. The number of moles in the reaction system can be expressed by:

$$(m_{AO} - m_{AO}y) + (m_{BO} - m_{AO}y) + m_{AO}y = m_{AO}(1 + \delta - y) \quad (10.2)$$

The mole fractions A, B and C respectively are:

$$x_A = \frac{1 - y}{1 + \delta - y}, \quad x_B = \frac{\delta - y}{1 + \delta - y}, \quad x_C = \frac{y}{1 + \delta - y} \quad (10.3)$$



Figure 10.10 Photograph of an Alkylation unit (Source:www.phxequip.com/Multimedia/images/plant/original/refinery-alkylation-unit-390.jpg. All rights reserved.).

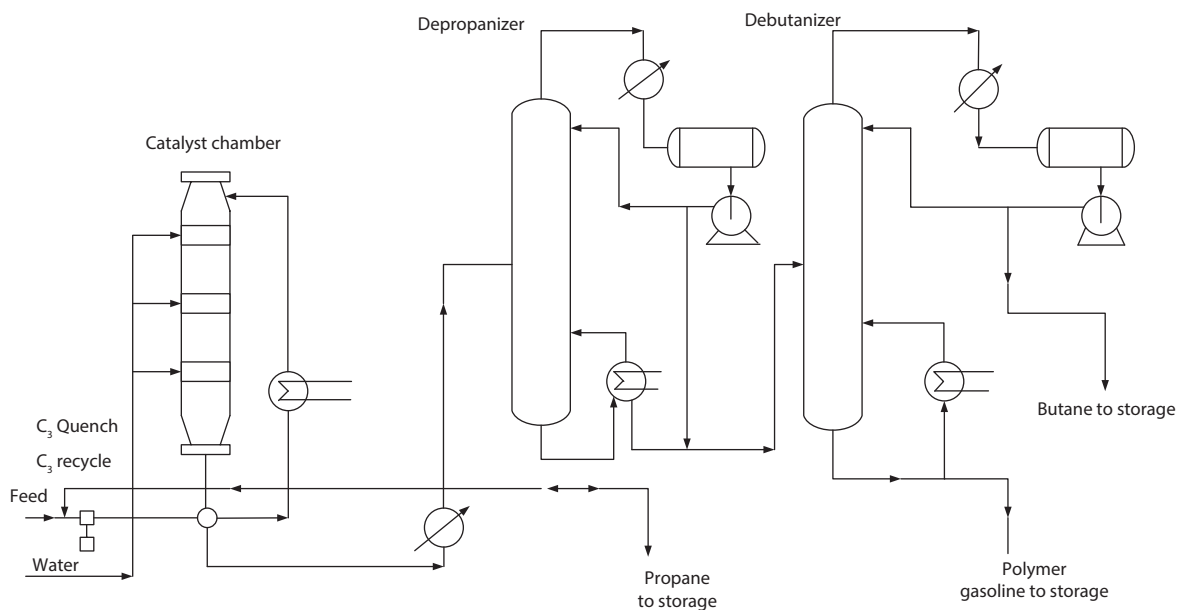


Figure 10.9 Process flow diagram of alkylation using UOP solid phosphoric acid.

The equilibrium constant $K_{x_{eq}}$ of reaction Eq. 10.1 is:

$$K_{x_{eq}} = \frac{k_1}{k_2} = \frac{x_C}{x_A x_B} = \frac{\frac{y}{(1+\delta-y)}}{\left(\frac{1-y}{1+\delta-y}\right)\left(\frac{\delta-y}{1+\delta-y}\right)} \quad (10.4)$$

$$K_{x_{eq}} = \frac{y(1+\delta-y)}{(1-y)(\delta-y)} \quad (10.5)$$

The degree of conversion, y is determined from the root of Eq. 10.5 $\left(x = \frac{-b \pm \sqrt{b^2 - 4ac}}{2a}\right)$ as:

$$y = \frac{(\delta+1) - \sqrt{(\delta+1)^2 - \frac{4K_{x_{eq}}}{K_{eq} + 1}}}{2} \quad (10.6)$$

Assuming an ideal solution and applying Raoult's law, the equilibrium constant in the gas phase is:

$$K_p = K_{x_{eq}} K_p^o \quad (10.7)$$

where K_p and $K_{x_{eq}}$ are the equilibrium constants of the reaction in the gas and liquid phases, and K_p^o is the standard gas equilibrium constant which can be calculated using the saturated vapor pressures of the compounds at the temperature of the reaction. K_p^o is determined by:

$$K_p^o = \frac{p_C^o}{p_A^o p_B^o} \quad (10.8)$$

where p_A^o , p_B^o , p_C^o are partial pressures of A, B and C respectively.

The alkylation reactions considered here are between olefins (butene or isobutene) and isobutane. Typical reactions and values of the equilibrium constant, K_p at different operating temperatures are shown in Table 10.10.

Example 10-1

Consider an alkylation reaction between isobutene (A) and isobutane (B) to give isooctane (C) at 300K. The partial pressures of the reacting species are: $p_A^o = 0.32 \text{ MPa}$, $p_B^o = 0.37 \text{ MPa}$ and $p_C^o = 0.005 \text{ MPa}$,

respectively. Plot the conversion versus dilution ratio at different equilibrium constant.

Solution:

The standard gas equilibrium constant can be evaluated as:

$$K_p^o = \frac{0.005}{(0.32)(0.37)} = 0.042 \text{ MPas}^{-1}$$

From Table 10.10, the equilibrium constant K_p for isobutene-isobutane at 300K is $1.1 \times 10^5 \text{ MPa}^{-1}$ (reaction 10-13). Therefore, the liquid phase equilibrium constant can be determined by:

$$K_{x_{eq}} = \frac{1.1 \times 10^5}{0.042} = 26.2 \times 10^5$$

Similarly, for 400K, $p_A^o = 2.94 \text{ MPa}$, $p_B^o = 3.16 \text{ MPa}$ and $p_C^o = 0.16 \text{ MPa}$, and $K_p = 76.0 \text{ MPa}^{-1}$ (Table 10.10). Thus

$$K_p^o = \frac{0.16}{(2.94)(3.16)} = 0.0172 \text{ MPas}^{-1}$$

and

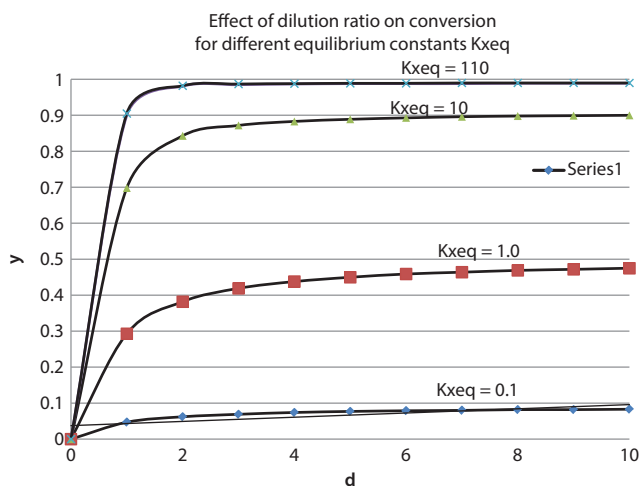
$$K_{x_{eq}} = \frac{76.0}{0.017} = 4.4 \times 10^3$$

Higher degrees of conversion (close to unity) are obtained when alkylation reactions occur in the liquid phase compared with the gas phase reactions at moderate pressures. For this reason, industrial alkylation processes for C_3 and C_4 alkenes and isobutane are conducted in the liquid phase at temperatures between 32–50 °F (0–10 °C) for sulfuric acid (H_2SO_4) catalyst or 68–104 °F (30–40 °C) for hydrofluoric (HF) acid catalyst. An Excel spreadsheet (Example 10-1.xlsx) has been developed for Example 10-1, and Figure 10.11 shows the relationship of conversion with dilution ratio (d) for different operating conditions, thus different values of the equilibrium constants. It is shown that y becomes close to unity at 300K, where $K_{x_{eq}} \geq 100$ and $d \geq 1.0$ for reaction (10.13) in Table 10.10.

A series of reactions resulting to the formation of alkylate bottoms and tar occur (Table 10.1). If solid acid catalyst is used, it requires higher temperatures to ensure favorable thermodynamic conditions. At industrial conditions with temperatures greater than 50 °F (10 °C), about 17 side reactions will occur, and the simple model fails to predict the kinetics in liquid phase.

Table 10.10 Equilibrium constant K_p for alkylation reactions at 1 bar in ideal gas phase (Zhorov, 1987 [10]).

Reaction	K_p (MPa ⁻¹)					Equation
	300K	400K	500K	600K	800K	
Ethylene + isobutane \leftrightarrow 2,3 - dimethylpentane	7.7×10^9	5.4×10^5	170.0	39.0	0.4	(10.9)
Propene + isobutane \leftrightarrow 2,3 - dimethylpentane	1.3×10^8	2.6×10^5	168.0	6.0	0.1	(10.10)
n-Butene + isobutane \leftrightarrow 2,2,4- trimethylpentane	21.7×10^6	2.82×10^3	14.0	0.40	5.2×10^{-3}	(10.11)
1 - Pentene + isobutane \leftrightarrow 2,2,5 - trimethylhexane	55.5×10^6	2.9×10^4	85.0	2.0	1.7×10^{-2}	(10.12)
Isobutene + isobutane \leftrightarrow 2,2,4 - trimethylpentane	0.11×10^6	76.0	1.0	0.06	1.7×10^{-3}	(10.13)
cis-2-Butene+isobutane \leftrightarrow 2,2,4 - trimethylpentane	2.4×10^6	662.0	4.0	0.2	4.5×10^{-3}	(10.14)
trans-2 Butene+isobutane \leftrightarrow 2,2,4 -trimethylpentane	0.77×10^6	303.0	3.0	0.1	3.0×10^{-3}	(10.15)
2-Methyl-2butene + isobutane \leftrightarrow 2,2,5 - trimethylhexane	0.23×10^6	105.0	1.0	0.06	1.9×10^{-3}	(10.16)

**Figure 10.11** Effect of dilution ratio d on conversion for different equilibrium constants ($K_{x_{eq}}$).

Effect of Operating Conditions

The process conditions that influence the quality of alkylate product and acid consumption rate are the olefin type, dilution ratio d (iC_4/iC_4^-), mixing temperature, impeller speed, space velocity (or residence time) and acid strength.

10.10 Polymerization

Polymerization processes have received considerable interest in petroleum refining because of the higher requirement of reformatted gasoline and the phasing of MTBE. The process may be attractive in two main areas:

- Upgrading of C_2 and temperature, 150–200 °C, pressure, 30–50 bar, space velocity 0.3–0.5 m³/hr/m³, cuts from catalytic cracking for oligomerization ethylene and propylene to olefinic gasoline.
- Producing high quality and middle quality.

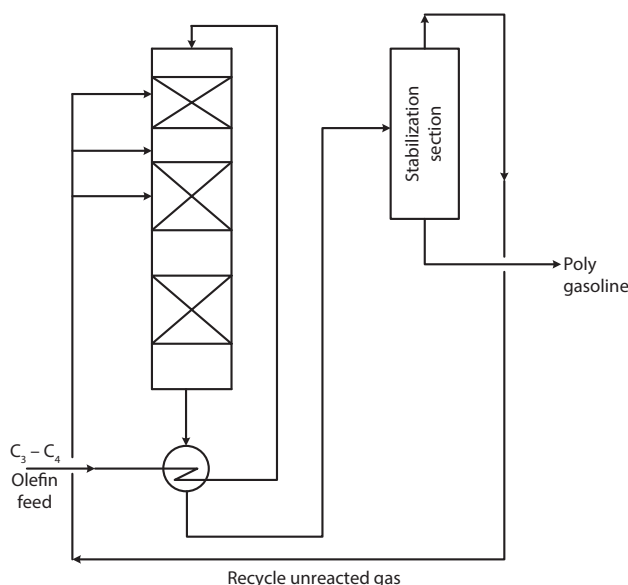
10.11 HF and H₂SO₄ Mitigating Releases

Growing environmental and public-safety concerns have heightened awareness of hazards associated with H₂SO₄ and HF acids. Refiners subsequently responded to these concerns with the installation of mitigating systems designed to minimize the consequences of accidental releases. ChrevonTexaco and UOP developed the Alkad technology to assist in reducing the potential hazards of HF. The two primary process hazards of alkylation are: 1) the unit process large volumes of light hydrocarbons, which are highly flammable and potentially explosive. 2) the acid catalyst is corrosive and toxic. Both Sulfuric Acid Alkylation Unit (SAAU) and Hydrofluoric Alkylation Unit (HFAU) contain similar volumes of hydrocarbon with similar risks, but the risks associated with each acid are quite different. HF requires much stricter precautions because of its greater potential to harm (this is due to its lower boiling point and higher harmful potential (see material safety data sheet (MSDS) of hydrofluoric acid). In this respect, the American Petroleum Institute has issued a Recommended Practice, specifically for HF alkylation units (API RP 751). This publication recommends that access to an HF alkylation unit be strictly limited due to the potential hazards of HF. There is no similar safety recommendation that is required in sulfuric acid

Table 10.11 Commercial polymerization processes.

Polymerization process	Description
UOP Catpoly process	The process is based on the polymerization of propylene, butane or a mixture of both using phosphoric acid as a catalyst, which is laid on a solid support of Kieselguhr type. The process consists of polymerization of C_3/C_4 stream in a multi-bed catalytic reactor. Propane is used as a coolant to adjust the temperature from the reactor; the polymerate is sent to the separator for removal of entrained acid and the stabilization section for separating the polymerate and light end products. Process conditions: temperature, 180–200 °C; pressure, 30–40 bar; space velocity 0.3–0.5 $m^3/hr/m^3$
HF Dimersol process	The process involves dimerization of olefin in a liquid phase reactor using soluble catalyst consisting of an organic nickel salt. The process units consist of a dimerization reactor, catalyst recovery, and stabilizer column. Process conditions: temperature, 40–50 °C; pressure, 10–30 bar; residence time 1–5 hours.
IFP Polynaphtha process	The process converts C_3/C_4 and C_5 olefins into a gasoline cut in a fixed-bed reactor using silicon-alumina as a catalyst. The process stream consists of a preheater, a reactor and a stabilization section for separating the polymerate from the light gases. Process flow diagram is shown in Figure 10.12. Process conditions: Temperature, 150–200 °C; pressure, 30–50 bar; space velocity, 0.3–0.5 $m^3/hr/m^3$, Product: Gasoline/gas oil.
Mobil olefin to gasoline and distillate (MOGD)	The process is based on oligomerization of light olefins to iso-olefins using ZSM-5 as a catalyst in four fixed-bed adiabatic reactors. Three of which remain in the reaction phase while the fourth is used for regeneration. Process conditions: Temperature, 150–200 °C; pressure, 7–12 bar; space velocity, 1–2 $m^3/hr/m^3$ of catalyst
NexOctane™	The process involves dimerization of isobutylene to isooctane which can be subsequently hydrogenated to produce iso-octane.
Octol Process	Normal butene containing isobutene is depleted C_4 hydrocarbons are oligomerized using the octol process in the liquid phase on a heterogeneous catalyst system to yield mainly C_8 and C_{12} olefins. The product will have a high octane as well as petrochemical feedstock for plasticizer or detergent.

(Source: Leprince, 1998, Irion and Neuwirth, 2003; Birkhoff and Nurminen, 2004; Nierlich, 1991.)


Figure 10.12 Polymerization process for polygasoline.

alkylation. Table 10.11 shows commercial polymerization processes.

Tests have shown that hydrofluoric acid (HF) could form a cold, dense aerosol cloud that did not rapidly dissipate and remained denser than air. Another set of tests were conducted to determine the effect of water sprays on an HF aerosol cloud. These tests showed that a water/HF ratio of 40/1 by volume would reduce the airborne HF acid by about 90%. As a result of these investigations, many refiners have installed water spray systems in their HF alkylation units to respond to accidental releases. Another mitigating response relates to inherent safer acid inventory reduction. HF detection system, isolation valves and rapid acid transfer systems. These mitigation systems can be described as external defensive response systems because they rely on an external reaction (e.g., spraying water) to a detected leak.

ChevronTexaco and UOP developed an internal passive system that would respond to leak detection. They cooperated to develop an additive system to reduce the risk associated with the HF alkylation process. The objective was to immediately suppress the HF aerosol in the event of a leak but would not otherwise interfere with the normal performance of the HF unit [7].

ConocoPhillips employed another step to reduce the risk by eliminating any pumps for circulating HF catalyst through the reactor system. Eliminating the rotating equipment, potential packing and seal failures associated with the equipment are thus removed together with the dangers of frequent maintenance exposure. Without the acid pump, isolation valves were no longer required for the reactor/settler circulation system. This also allows the acid settler to operate at a minimum pressure, which minimizes the leak rate [8].

10.12 Corrosion Problems

There are significant advances in process technology of SAAU and HFAU; however, there continue to be recurring corrosion problems that affect the safety and reliability of HFAU. Any section of the unit in contact with HF requires to be built with suitable materials. Carbon steel is the most common material used, although it requires tight controls on composition and hardness. Alternative more corrosion-resistant materials such as Monel are sometimes used. However, these materials are expensive and could carry their own risks such as stress corrosion cracking. Proper operating procedures, material inspection, maintenance, transportation and inventory control and are essential on HFAUs and should be conducted on a frequent basis than most other units in the refinery.

The tanks containing the alkylate produced through HFAU should be monitored continuously, as the alkylate produced contains small impurities of HF corrosion products. If the alkylate enters in contact with water (e.g., in the bottom of the tank), HF can reform in the water and cause corrosion of the steel. Many refineries choose a weak caustic of water in the bottom of their alkylate tanks in order to neutralize any acid that may form. pH monitoring of the tank water is necessary to assess if any HF is formed downstream. SAAU corrosion is a less dominant concern and can be monitored by minimizing the amount of water entering the process.

10.13 A New Technology of Alkylation Process Using Ionic Liquid

Isobutane alkylation is a common refinery process used to produce high-quality gasoline, and the most desirable components in alkylate gasoline are trimethyl pentane (TMPs), which have the research octane number greater than 100. As described earlier in this chapter, conventional alkylation processes that use either sulfuric acid (H_2SO_4) or anhydrous hydrofluoric acid (HF) as catalysts. This has significant safety and environmental concerns due to the large handling of large quantities of spent H_2SO_4 or hazardous HF acids.

Solid acids as catalysts have shown promise for alkylation as they are less hazardous and have been subjected to various studies [13, 14]. However, these catalysts deactivate very rapidly resulting in low product yield and loss of reaction selectivity [15]. The rapid deactivation is because of the buildup of carbenium ions and active sites of the solid catalysts. Once this carbonaceous material is formed, it is difficult to remove from the narrow catalyst pores. Furthermore, the cost of solid-acid catalyst is high and there is no adequate method for regenerating the spent solid-acid catalyst.

Ionic Liquid Catalyst

Ionic liquid alkylation process has recently been employed as an alternative catalyst for the isobutane alkylation. The process uses a composite-IL as a homogeneous catalyst for alkylation reactions at ambient temperatures and moderate pressures. ILs are ionic, salt-like materials that are liquid at less than 100 °C [16]. ILs have been used as solvents and homogeneous catalyst due to their negligible vapor pressure, good solubility to a wide range of organics and inorganic compounds and ability to be recycled for reuse [17, 18].

Acidic chloroaluminate (III) IL has been used as a homogeneous catalyst for isobutane alkylation, which eliminates the diffusion limitation present with solid-acid catalyst system. The alkylated gasoline is easily separated from the ionic liquid trimethyl pentane (TMP) yield, and selectivity are low in systems with conventional-IL. This happens with or without adjusting the IL's acidity by varying either the molar fraction of aluminum chloride ($AlCl_3$) of the IL or adding hydrochloric acid (HCl) [19, 20].

Roebuck and Evering [21] showed that adding aromatic hydrocarbons and metal chlorides to aluminum chloride-dialkyl ether complex increased trimethyl

pentane selectivity. Furthermore, adding aromatic hydrocarbons and metal chlorides enhance the acidity of catalyst for alkylation reactions and inhibit undesirable side reaction such as isomerization and cracking. Studies showed that when aromatic hydrocarbons and cuprous chloride (CuCl) were added to a conventional-IL, high yield of trimethyl pentane and selectivity were achieved. However, when cuprous chloride was added to aluminum chloride-dialkyl ether complex or conventional-IL, a formation of fine suspension is obtained that presents a problem to separate and recycle in a continuous flow system.

Liu *et al.* [22] carried out a pilot plant study in the commercialization of IL-catalyzed isobutene alkylation using a composite-IL catalyst, a liquid compound that is synthesized with a conventional-IL catalyst and CuCl. The composite-IL catalyst has anions in the form of ligands with two or more metallic centers. The studies were to optimize the performance of composite-IL catalyst in alkylating isobutane. The olefin conversion was > 99% for the pilot plant studies and Table 10.12 summarizes the product yield and properties of

alkylate gasoline. The C₈ yield in alkylate gasoline was > 95 wt% and the yield of TMPs was 90%. The high yield of C₈ and TMP selectivity of composite-IL catalyst are because of high concentration of AlCl₃CuCl- ligands.

The performance of the ionic liquid alkylation process in the studies was compared with the bench-scale studies, and the result shows that the commercial composite-IL catalyst performed in an identical manner to that developed in the pilot-plant and produced a stable activity.

Furthermore, neither the composite-IL catalyst nor its decomposed species was detected in alkylate gasoline, indicating a good separation of composite-IL catalyst from alkylate gasoline and chemical stability of composite-IL catalyst. Inspection of the unit also showed no detectable corrosion occurred during the trial plant studies. Figure 10.13 shows a process flow diagram of the composite ionic liquid alkylation unit. The ionic liquid alkylation process is shown to be environmentally friendly and energy efficient. The process can be easily retrofitted to an existing H₂SO₄ or HF alkylation units.

Table 10.12 Alkylation comparison [24].

Yield, wt%	Process		
	Ionikylation	HF	HSO ₄
C ₅	0.6	2.5	8.8
C ₆	1.0	1.9	4.9
C ₇	2.0	2.9	3.9
C ₈	95.6	90.1	80.7
C ₉₊	0.8	2.6	5.7
C ₈ components			
TMPs	89.6	80.9	71.6
2,2,3 – TMP	0.1	1.6	2.3
2,2,4 – TMP	51.6	49.7	31.1
2,3,3 – TMP	18.1	10.8	19.8
2,3,4 – TMP	19.8	18.8	18.4
DMHs	6.0	9.2	9.0
2,3 – DMH	1.3	-	-
2,4 – DMH	3.4	-	-
2,5 – DMH	1.3	-	-
3,4 – DMH	0	-	-
TMP: DMH ratio	14.9	8.8	8.0
RON	100.1	97.3	97.6
MON	95.0	95.2	94.4

10.14 Chevron – Honeywell UOP Ionic liquid Alkylation

Chevron – Honeywell UOP has developed a proprietary ISOALKY technology that uses ionic liquid instead of HF or sulfuric acids as a liquid alkylation catalyst for the production of high-octane fuels. Increasing C₃ – C₅ olefin feed flexibility and lowering handling risk against HF and H₂SO₄ acids, ISOALKY enables catalyst regeneration to occur within the unit, thus lowering catalyst consumption by 400 times vs. H₂SO₄.

The technology uses a non-aqueous liquid salt, or ionic liquid at temperatures below 100 °C to convert a typical stream from a fluid catalytic cracking unit into a valuable high-octane blending components that lowers the environmental impact of motor gasoline.

Other benefits from the technology, ionic liquids process can be used in new refineries as well as existing facilities undergoing capital expansion. It can produce alkylate from a wide range of feedstocks using a lower volume catalyst. This liquid catalyst has a negligible vapor pressure and can be regenerated on-site, giving it a lower environmental footprint than other technologies.

Ionic liquids have strong acid properties, enabling them to perform acid catalysis, but without the volatility of conventional acids. They are a salt in the liquid state, comprising largely of ions that convert C₄

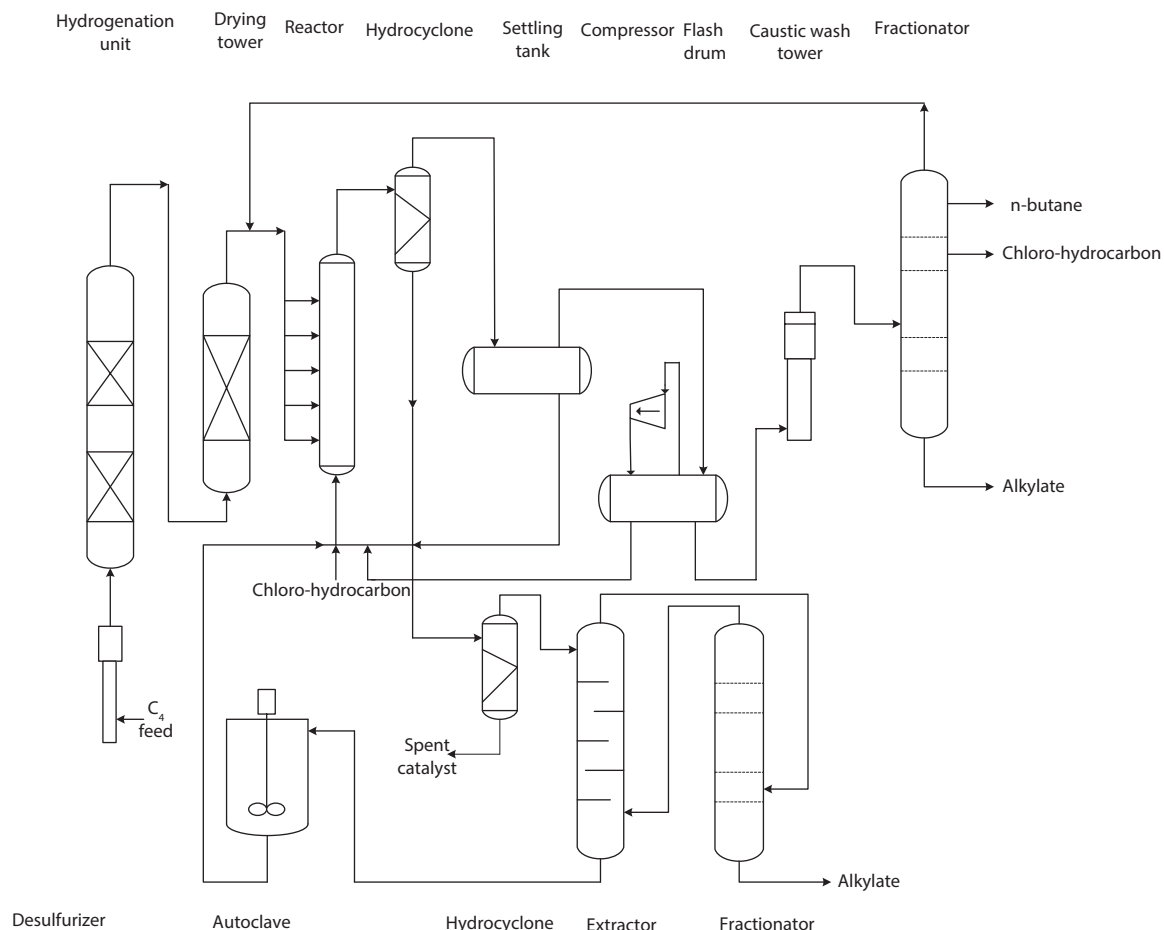


Figure 10.13 Process flow diagram of composite ionic liquid Alkylation (CILA).

paraffins and other olefins into an excellent gasoline-range blending product, and because of its low vapor pressure, ionic liquid requires simpler handling procedures than either sulfuric or hydrofluoric acid.

10.15 Chemical Release and Flash Fire: A Case Study of the Alkylation Unit at the Delaware City Refining Company (DCRC) Involving Equipment Maintenance Incident.

Description of DCRC alkylation Unit.

Alkylation is a refinery unit operation in which lighter hydrocarbons react with isobutane in the presence of an acid catalyst (sulfuric or hydrofluoric acid) to produce a larger branch-chain hydrocarbons molecules with a high-octane rating. The alkylation unit

at DCRC receives butylenes from the fluid coker unit and the fluid catalytic cracker (FCC) unit. The alkylation unit contains two alkylation reactor sections, each comprised of two reactors that run in parallel. When operated at lower temperatures, the reaction produces a higher-quality alkylate. Propane and excess isobutane cycle through the reactors to cool the reaction and are then condensed and sent back to the alkylation reactors. A small amount of the propane and excess isobutane recycle stream is purged to the depropanizer column. The depropanizer column maintains optimal propane concentration in the unit removing excess propane. Prior to entering the depropanizer column, the alkylation reactor purge streams travel through a caustic wash system to mitigate the risk of corrosion by removing trace amounts of sulfur dioxide.

The incident that occurred in November 2015 was in the caustic wash section of the alkylation unit. Caustic sodium hydroxide is used to scrub trace amounts of sulfur dioxide (SO₂) from the purge streams in a caustic settler (see Figure 10.14). The solution is then fed to

a coalescer or “carry over” vessel to ensure the caustic and water mixture is removed from the hydrocarbon stream prior to entering the depropanizer column. Caustic in the stream is removed in the caustic settler through the drain valve and recirculated into the process. Occasionally, spent caustic is extracted from the caustic settler and routed to a quench drum prior to venting to the refinery flare system.

On the day of the incident, alkylation unit operators were preparing equipment for turnover to the maintenance department, as the maintenance activity involved replacing a 20-foot section of the thinning piping located between the caustic settler drain line and the caustic recirculation pump (Figure 10.15), which was identified during a routine inspection process (Figure 10.16). For the maintenance department to replace the piping, operators had to first drain and isolate it. Previously, operators planned to isolate the caustic settler from the pumps by closing the caustic drain valve (Figure 10.17), which is immediately downstream of the caustic settler and upstream of the line that needed replacement. Some days before the incident, operators noticed that the caustic drain valve was leaking and would not seal properly, and this resulted in material passing through the valve when in the closed position.

The operators decided to expand the isolation to another block valve downstream of the coalescer and settler as they could not isolate the section of piping that needed replacement. Therefore, the caustic settler and the coalescer were included in the isolation. Additionally, the expanded isolation plan required removing the contents of the coalescer to ensure the line to be replaced was free of hydrocarbon (Figure 10.18).

On November 29, 2015, alkylation unit operators at the Delaware City Refining Company or DCRC were preparing equipment for maintenance. Prior to performing the work, operators had to first drain and isolate a section of piping scheduled to be replaced by closing valves to block the flow of hydrocarbons into the piping. However, the operators learned that a valve on one side of the pipe isolation was leaking and therefore, would not seal properly, which led staff to expand the isolation to a downstream block valve. That expansion did not trigger additional hazard review. The next available valve included additional equipment not involved in the original isolation plan which needed to be drained to ensure complete removal of flammable hydrocarbons.

A single block valve isolated the vessels being decontaminated from a pressurized and inventoried depropanizer column containing hydrocarbons. Unknown to the operations’ personnel, the valve leaked in the closed position, resulting in backflow of flammable material



Figure 10.15 20-foot replacement piping (Source: csb.gov).

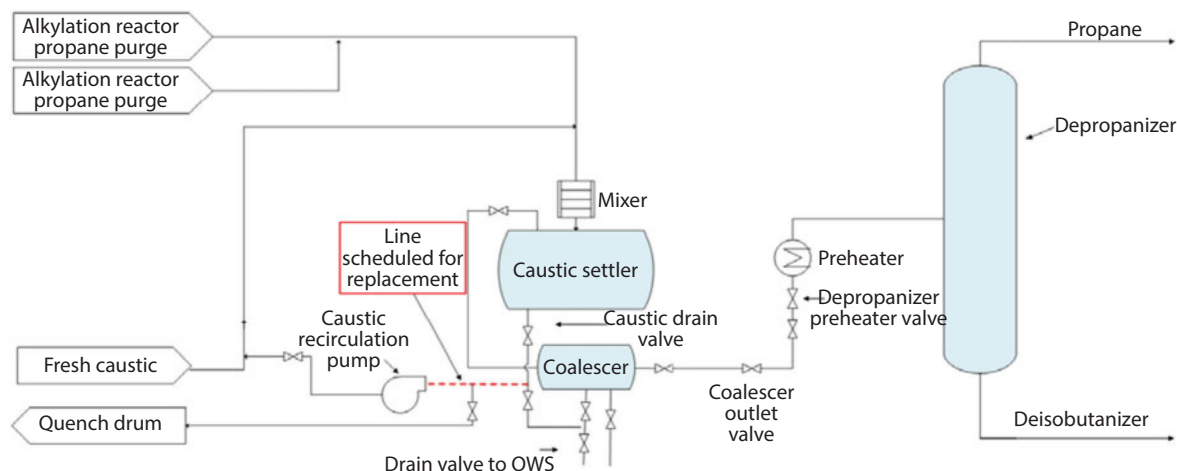


Figure 10.14 Simplified process flow diagram of depropanizer caustic wash system (Source: csb.gov).

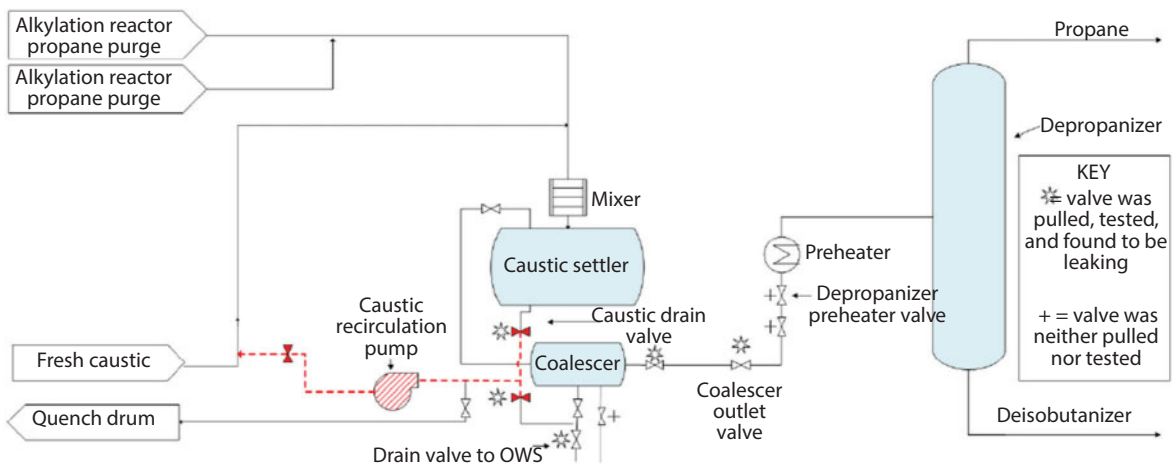


Figure 10.16 Original isolation plan shown in red (Source: csb.gov).

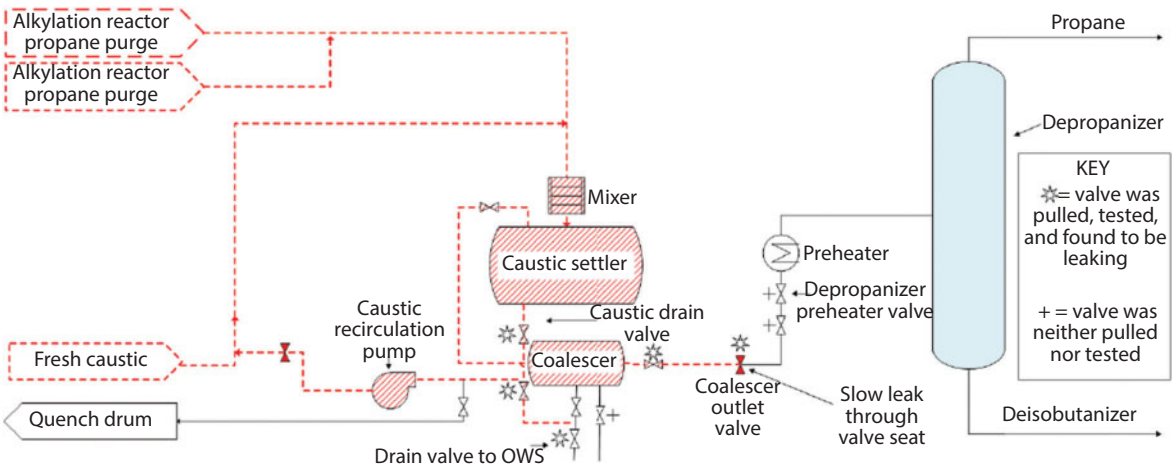


Figure 10.17 Expanded isolation plan shown in red (Source: csb.gov).

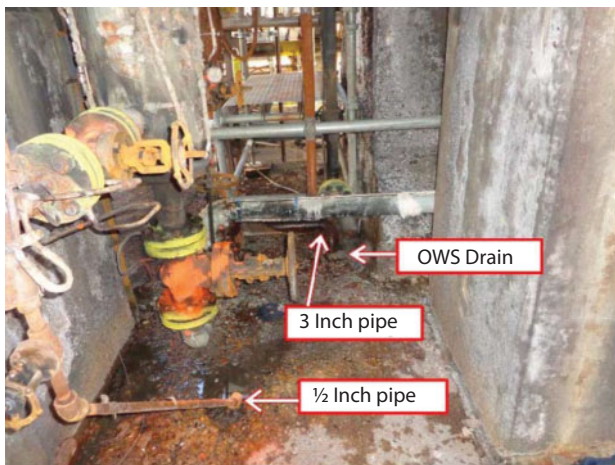


Figure 10.18 Photograph of drain pipes associated with DCRC incident (Source: csb.gov).

from the depropanizer. When the operator opened the vessel drain valve to empty what he assumed was condensate water from the vessel to the oil water sewer (OWS), the hydrocarbons from the depropanizer also released to the sewer and ignited resulting in a flash fire, which seriously injured the operator as he suffered second-degree burns to the face and neck and third-degree burns to the wrist from the flash fire.

CSB conclusion and recommendations/key lessons

CSB investigation found that prior to the incident, DCRC did not have general procedures for preparing equipment for maintenance or procedures for taking those pieces of equipment out of service. If DCRC

had identified and addressed potential hazards before commencing the work, this incident would not have occurred.

The Chemical Safety Board (U.S.) concluded in their investigation that hydrocarbons in the depropanizer column likely back flowed through the leaking 4-inch coalescer outlet valve into the coalescer and caustic settler, and most likely ignited the hydrocarbons when the operated began draining the contents of the vessel into the OWS (Figure 10.19). The hydrocarbon vapor, made up of mostly highly flammable isobutane and propane, found an ignition source at the furnace (Figure 10.20), and the flash fire travelled back toward the operator's location. Flames overcame the operator at the base of the coalescer and caustic settler. Six-inch collection drains at a number of pump stations (Figure 10.21) are located en route to the OWS collection drum, and the pathway for the OWS is located in an orientation that brings it in close proximity to the operating furnace, with the closest drain about 25 ft. from a furnace (Figure 10.22). Figure 10.23 shows a photograph of the alkylation unit during maintenance activity.

Key lessons

- Operational tasks that involve preparing equipment for maintenance can be uncommon and

non-routine; therefore, ensure standard operating procedures include steps for preparing all process equipment for maintenance. Covering tasks such as emptying, decontaminating, washing, steaming, purging and draining equipment and vessels.

- For all equipment preparing activities, develop a process that requires pre-planning and hazard identification prior to initiating the work, which includes assessing hazards that may



Figure 10.20 Burner on furnace (Source: csb.gov).

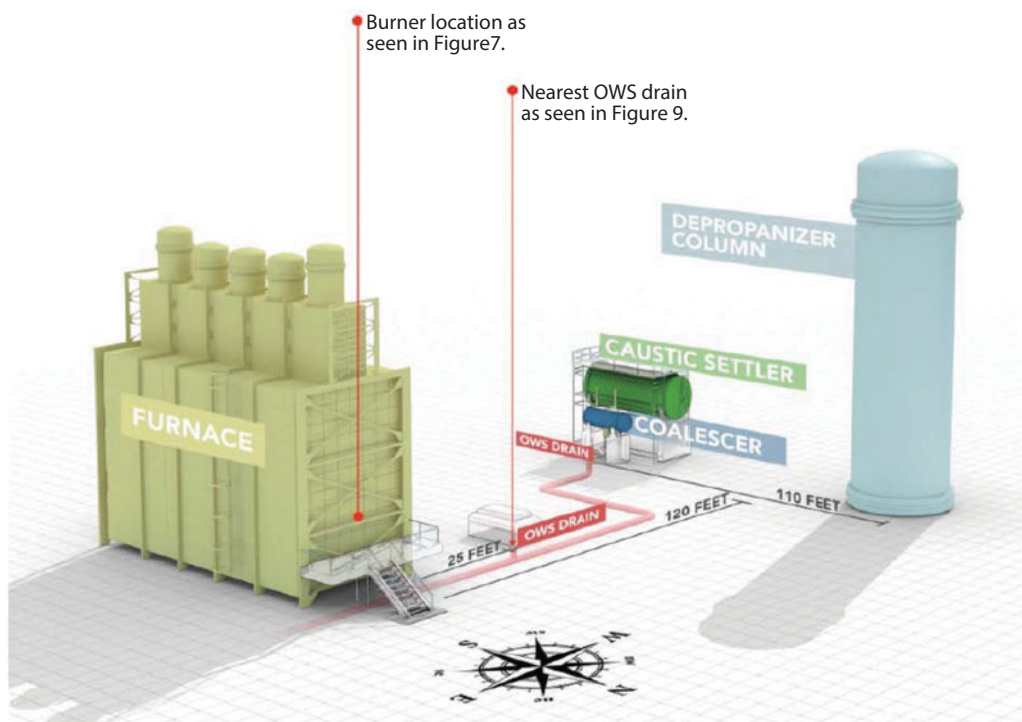


Figure 10.19 Diagram (not to scale) of depropanizer caustic wash system and associated equipment (Source: CBS.gov).



Figure 10.21 Typical pump drain to Oil Water Sewer (OWS) (Source: csb.gov).



Figure 10.23 Photograph of DCRC Alkylation unit during maintenance (Source: csb.gov)

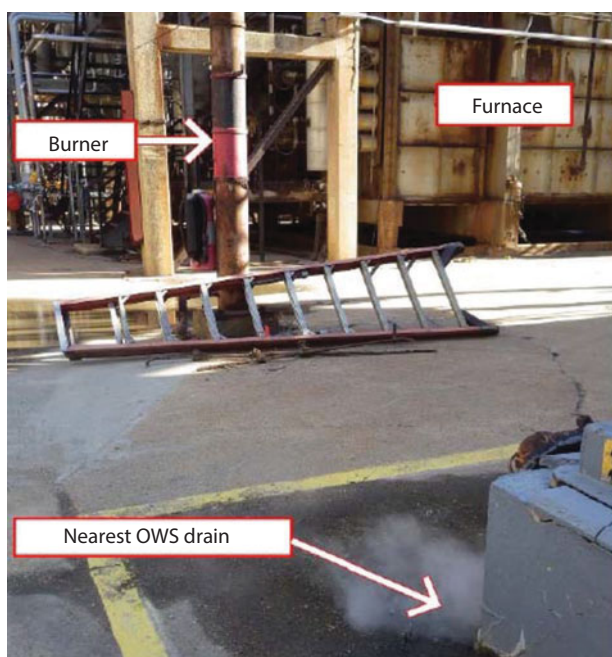


Figure 10.22 Proximity of furnace to Oil Water Sewer (Source: csb.gov).

be introduced and steps for mitigating those hazards.

- When isolating equipment for emptying or decontaminating activities prior to maintenance work, avoid relying on single block valves, even when the valves are newly installed, to control the release of hazardous energy. Always consider more protective measures for isolation such as including double blocks or blinds.
- When an equipment preparation task or isolation plan needs to be modified or expanded due to leaking valves or changing conditions, initiate a process to evaluate hazards that may be introduced by the change.

- Avoid draining materials containing, or potentially containing, hydrocarbon or flammables into the sewer or other systems not specifically designed for such services, especially when ignition sources are present. Use closed system such as tanks, drums, flares, etc., to control the draining, relieving of hazardous energy in preparation to isolate equipment for maintenance.

Before the maintenance work, operations personnel usually prepare equipment by depressurizing, de-inventorying, washing and draining. These activities often involve opening process equipment and piping, which can result in a release of hazardous energy. Though equipment preparation activities can occur rather frequently in process plants, the tasks involve may vary among pieces of equipment and piping and combination of equipment, and thus may be non-routine and not be included in an existing procedure.

References

1. Process Pro Eric, Refinery Alkylation Basics – Refinery Link, Oil Refiner Knowledge Portal, Feb. 8, 2016.
2. Payne, R. E., *Petrol. Refiner*, 37 (9), 316–329, 1958.
3. Hengstebeck, R. J., *Petroleum Processing*, McGraw-Hill Co., New York, pp 218–233, 1999.
4. Mukherjee, M. and J. Nehlsen, Consider Catalyst Developments for Alkylation Production, *Hydrocarbon Processing*, p 85, Sept. 2006.
5. Graves, David C., Chapter 1.2 Stratco Effluent Refrigerated H₂SO₄ Alkylation Process, Robert A.

- Meyers, *Handbook of Petroleum Refining Processes*, 3rd ed., McGraw-Hill Handbooks, 2003.
- James H. Gary, Handwerk, Glenn E., and Mark J. Kaiser, *Petroleum Refining Technology and Economics*, 5th ed., CRC Press Taylor & Francis Group, 2007.
 - Kurt A. Detrick, Himes, James F., Meister, Jill M., and Franz-Marcus Nowak, Chapter 1.4, UOP HF Alkylation Technology, Robert A. Meyers, *Handbook of Petroleum Refining Processes*, 3rd ed., McGraw-Hill Handbooks, 2003.
 - Gravelly, Mark L., Chapter 1.7 ConocoPhillips Reduced Volatility Alkylation Process, Robert A. Meyers, *Handbook of Petroleum Refining Processes*, 3rd ed., McGraw-Hill Handbooks, 2003.
 - Kaes, Gerald L., *Refinery Process Modeling : A Practical Guide to Steady State Modeling of Petroleum Processes*, 1st ed., Kaes Enterprises, Inc., 2000.
 - Zhorov, Yu, M., *Thermodynamics of Chemical Processes*, MIR Publisher, Moscow, 1987.
 - Tyas, Andrew R., and Tony Parker, A flexible approach to refinery olefin alkylation, *Petroleum Technology Quarter*, pp 65–73, Spring 2002.
 - Jones, D. S. J., *Elements of Petroleum Processing*, John Wiley & Sons Ltd., March 1996.
 - Corma, A., and A. Martinez, Catalysts and processes for isoparaffin-olefin alkylation, *Catal. Rev.*, Vol. 35, No. 4, pp 483–570, 1993.
 - Hommeltoft, S. I., Ekelund, O., and J. Zavilla, Role of ester intermediates in isobutene alkylation and its consequence for the choice of catalyst system, *Ind. Eng. Chem. Res.* Vol. 36, No. 9, pp 3491–97, 1997.
 - Weitkamp, J. and Y. Traa, Isobutane/butene Alkylation, on Solid Catalysts, *Catal. Today*, vol. 49, No. 2, pp 193–99, 1999.
 - Rogers, R. D., and K. R. Seddon, Ionic Liquids: Solvents of the future? *Science*, Vol. 302, No. 5646, pp 792–93, 2003.
 - Rogers, R. D., and K. R. Seddon, eds., *Ionic Liquids as Green Solvents: Progress and Prospect*, ACS Symposium Series 856, American Chemical Society, Washington, DC, 2003.
 - Welton, T., Room-temperature ionic liquids. Solvents for synthesis and catalysis, *Chem. Rev.*, Vol. 99, No. 8, pp 2071–83, 1999.
 - Huang, C. P., Liu, Z. C., Xu, C. M., Chen, B. H., and Liu, Y. F., Effects of additives on the properties of chloroaluminate ionic liquids catalyst for alkylation of isobutane and butene, *Appl. Catal., A: General*, No. 277, pp 41–43, 2004.
 - Olivier-Bourbigou, H., and F. Hugues, *Ionic Liquids in Synthesis*, Wiley – VCH, Weinheim, Germany, pp. 258–81, 2003.
 - Roebuck, A., K., and B. L., Evering, Isobutane – olefin alkylation with inhibited aluminum chloride catalysts, *Ind. Eng. Chem. Prod. Res. Dev.*, Vol. 9, No. 1, pp 76–82, 1970.
 - Liu, Zhichang, Zhang, Rui, Xu, C. and R. Xia, Ionic Liquid alkylation process produces high – quality gasoline, *Oil & Gas Journ.*, Sept. 23, 2006.
 - U.S. Chemical Safety and Hazard Investigation Board (CSB) Delaware City Refining Company Safety Bulletin, May 2017.

11

Hydrogen Production and Purification

Introduction

Hydrogen is one of the important feedstocks in the refinery and hydrogen consumption has greatly increased as the refiners increase the degree of conversion of processing heavy sour crude. Furthermore, there has been a high increase in the utilization of hydrogen during recent years because of more stringent environmental standards for the reduction of sulfur, aromatics and improvement in quality of gasoline, diesel and fuel oil. Additionally, the requirement for transportation fuels for improving the air environmental quality and improved gasoline quality for reducing aromatics and improvement in cetane number of diesel has resulted in greater installation and hydroprocessing and hydrocracking processes in modern refinery facilities that require increase in hydrogen requirement. These units require further additional hydrogen supply. Although the reformer produces hydrogen, this is insufficient to meet the enhanced requirement of hydrogen due to increased number of hydrocracking and hydroprocessing units.

11.1 Hydrogen Requirements in a Refinery

Hydrogen consumption in the refinery has increased during the past decade for clean transportation fuels (e.g., ultra-low-sulfur fuels), and increase in the application of residue conversion technologies that are accompanied by heavier crude processing and the demand for petrochemicals and further realization of refinery/petrochemical integration. The need to abate refinery carbon dioxide (CO₂) emissions is essential due to the governmental regulations worldwide and therefore, hydrogen production is likely to be closely scrutinized as approximately 10 tons of CO₂ is produced per ton of hydrogen produced [1].

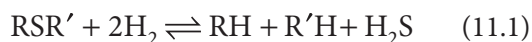
The demand of hydrogen use varies from processing unit to another and often depends on crude oil types, processing schemes and products and their characteristics and environmental concerns of various products. Balancing hydrogen consumption is a major concern in a modern refinery. Pure hydrogen is employed in the refinery for the following:

Hydrogen production is a catalytic reforming process. Feed gas, mainly methane (CH_4) is compressed and desulfurized and is then reacted with steam in a reforming furnace to give a mixture of hydrogen and carbon monoxide with some carbon dioxide (CO_2). The carbon dioxide is removed in the Sulfinol unit. The gas from the Sulfinol unit, consisting of hydrogen with small amounts of methane, carbon monoxide and carbon dioxide passes to the methanator, where carbon monoxide and carbon dioxide react with some hydrogen to form more methane. The product gas is mainly hydrogen with the balance being mainly methane.

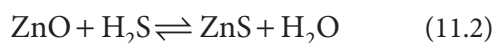
11.2 Process Chemistry

Desulfurization

The feedstock must first be desulfurized because the reforming low-temperature shift and methanation catalysts are poisoned by sulfur. Hydrogen sulfide is adsorbed by molecular sieves. The feedstock is then heated and passed through cobalt-molybdenum oxide on an alumina catalyst, where organic sulfur is reduced to hydrogen sulfide:



However, unsaturated hydrocarbons and carbon oxides also react with hydrogen over the catalyst causing a temperature rise that may be significant. Allowance for hydrogen content and feed temperature to the reactor with cobalt-molybdenum oxide catalyst is made. The final stage of the desulfurization is the reaction of hydrogen sulfide with zinc oxide as follows:



Zinc oxide is active at temperatures in the range of 260 °C–454 °C; optimum performance is exhibited at about 399 °C. The sulfur is removed to less than 1 ppm residual in the treated gas. The spent zinc oxide cannot be regenerated economically and is thus discarded.

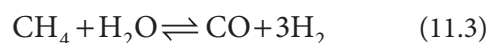
The spent zinc oxide reagent is pyrophoric, and may be hydrolyzed to produce hydrogen sulfide. Since it is pyrophoric, it must be cooled to ambient temperature before exposure to the atmosphere.

Reforming

The reforming reactions are generally equilibrium reactions, which imply that the conversion with the aid of the nickel catalyst approaches the maximum conversion that can be achieved at the reaction temperature

and pressure. In addition to the activity of the catalyst, the reaction temperature and pressure as well as the amount of steam employed to have a great effect on the quality of hydrogen steam produced.

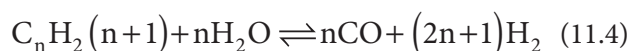
The steam-hydrocarbon reforming reaction is conducted at high temperatures and is highly endothermic. The heat of reaction is supplied by firing externally to the catalyst-packed tubes in the radiant section of the reforming furnace, where the following reactions take place:



$$\Delta\text{H} = +206 \text{ kJ/mol}, \quad \Delta\text{G}_{298} = -58.096 \text{ kJ/mol}$$

For light hydrocarbons other than methane, the reforming reaction becomes:

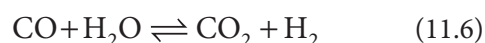
In general



This reaction occurs through the conversion of the light hydrocarbons to methane followed by the methane reforming reaction. Overall, the reforming reaction of (11.4) is endothermic.



In addition to steam reforming, water-gas shift reaction also takes place in the reformer. The reaction is as follows:



$$\Delta\text{H} = -41 \text{ kJ/mol}, \quad \Delta\text{G}_{298} = -28.606 \text{ kJ/mol}$$

Reforming catalyst consists of nickel oxide (15–25 wt%) supported on an inert carrier. Various modifications of the catalyst are active at temperatures and pressures of 538 °C to 1,316 °C and 0 to 27 barg respectively. Active steam-hydrocarbon reforming catalyst is pyrophoric and should be oxidized under controlled conditions before exposure to the atmosphere.

Reforming catalysts are sensitive to rapid changes in temperature resulting in physical degradation. They should not be heated or cooled more rapidly than 50 °C/h, and if water is present, this rate should be reduced to 25 °C/h.

Since methane is more stable than other higher hydrocarbons at usual reforming temperatures and pressures, the effluent composition is set by the equilibrium between steam, methane, hydrogen, carbon monoxide, and carbon dioxide. Even though ethane, propane, and higher hydrocarbons may be used as

the reformer feed materials, none appears in the effluent. High temperature favors kinetics and equilibrium conversion of reforming reactions, while low pressure favors equilibrium only. Materials economically available for the construction of reforming heater catalyst tubes limit reaction temperatures.

The operating pressure is a compromise between limitations in the tube metallurgy and overall power requirements. The highest practical pressure is used,

since less power is required to compress the feed gas than to compress the hydrogen product. The water-gas shift reaction equilibrium is unaffected by pressure but favored by low temperatures. However, the kinetics is more favorable at high temperatures. Figure 11.1 shows a schematic diagram of hydrogen production from steam reforming and Table 11.1 gives a typical design condition and composition of naphtha feed to the reformer.

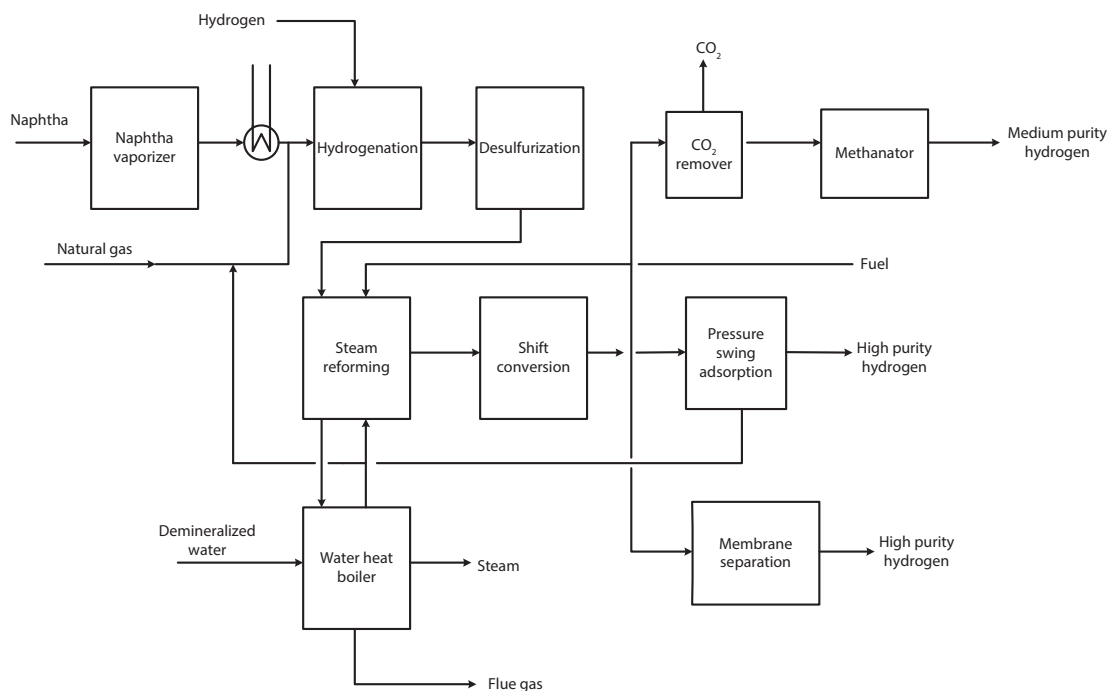


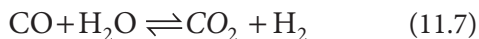
Figure 11.1 Hydrogen production from steam reforming of natural gas.

Table 11.1 Typical design condition and composition of naphtha feed to the reformer.

	Design condition for naphtha reformer	Feed to the reformer
Specific gravity (15/15)	0.73	0.71
PONA analysis (wt% vol) method		% vol
Total paraffins	54–76	78.4
Naphthenes	19–27	14.6
Aromatics	< 10	7
Sulfur content (wt ppm)	1000	< 0.5
Chlorides (wt ppm)	4	< 0.1
Arsenic (wt ppm)	4	< 0.1
Lead (wt ppb)	100	< 0.1
Nickel (wt ppm)	100	Not indicated
Nitrogen (wt ppm)	4	Not indicated
Vanadium (wt ppm)	100	Not indicated
Copper (wt ppm)	20	Not indicated

11.3 High-Temperature Shift Conversion

The bulk of the carbon monoxide in the reforming furnace effluent is converted to carbon dioxide over the catalyst in high-temperature shift reactor by the water-gas shift reaction:



The reaction is exothermic and is conducted in a fixed-bed catalytic reactor at 650 °F (343 °C). High-temperature shift catalyst is chromium-promoted iron oxide in the ferrous and ferric states of oxidation.

The catalyst must be activated by reduction of the ferric to ferrous state of oxidation. The catalyst is activated at about 316 °C by treating it with steam at space velocities of about 200 and about 2 vol% of process gas containing reducing substances such as carbon monoxide and/or hydrogen. The catalyst may be preheated by use of steam, air, feed gases or reformer effluent.

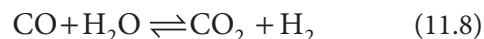
Fresh high-temperature shift catalyst contains trace quantities of sulfur and chlorine. These are removed from high-temperature shift catalyst by operating at about 425 °C until no sulfur in the effluent can be detected prior to admitting the effluent to low-temperature shift catalyst. Heating and cooling rates of the high-temperature shift catalyst are limited to 83 °C–110 °C/hr to avoid physical degradation.

The reaction equilibrium for water-gas shift conversion of carbon monoxide to carbon dioxide and hydrogen is more favorable at lower temperatures. However, the reaction kinetics decreases with decreasing temperatures to a point at which the catalyst is practically inactive below 316 °C. Optimum catalyst operating temperatures are in the range of 327 °C to 482 °C; however, the maximum allowable operating temperature is 425 °C at the outlet. Since the reaction system undergoes no volumetric change, pressure will not affect its equilibrium. However, increasing the pressure, favors the kinetics due to higher loading of the active catalyst surface. This characteristic is more pronounced at lower pressures and decrease as 28 barg is approached.

11.4 Low-Temperature Shift Conversion

The residual carbon monoxide in high-temperature shift reactor effluent is further decreased by water-gas

shift conversion over the catalyst in low-temperature shift reactor, where the exothermic reaction is:



Equilibria and kinetics of the reaction are similar to those discussed earlier. Because the catalyst retains its activity at lower temperatures, lower residual carbon monoxide contents can be achieved. The low-temperature shift catalyst contains a mixture of metallic oxides, including copper. Operating temperatures and pressures are in the range of 177 °C–260 °C, and 0–27 barg respectively.

The catalyst requires reduction; sulfur and chloride-free steam, nitrogen or natural gas may be used as an inert carrier gas in preheating or reducing the catalyst with 2 volt reducing gas in the carrier at a space velocity of 200 at 204 °C–221 °C. The reaction is exothermic and unless the reduction process is controlled, very high temperatures will result that can permanently deactivate the catalyst. The reduce catalyst is pyrohoric and must be oxidized under controlled conditions before exposure to the atmosphere.

In general, catalyst operating temperatures are restricted to below 260 °C– 288 °C, but at least 28 °C above the steam dew point. Heating and cooling rates are limited to 83 °C–110 °C per hr to avoid physical deterioration.

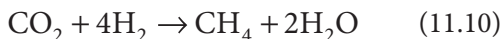
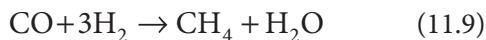
In addition to the loss of catalyst due to overheating, the catalyst is also sensitive to unsaturates, chloride and sulfur. Chlorides and sulfur compounds deactivate the catalyst permanently. New charges of high-temperature shift catalyst contain sufficient amounts of sulfur and chlorides to deactivate low-temperature shift catalyst. Therefore, high-temperature shift catalyst must be activated and placed in service, and the effluent gas must be thoroughly checked as sulfur-free prior to introducing it to the low temperature shift catalyst in new plant start-ups or when replacing high-temperature shift catalyst.

11.5 Gas Purification

Carbon dioxide is removed from the cooled shift effluent gas by absorption in a circulating amine, Sulfinol unit or hot potassium carbonate solution. Several other treating solutions can be employed. The treating solution contacts the hydrogen and carbon dioxide gas in an absorber containing about 24 trays or the packing. Carbon dioxide is absorbed in the solution, which is then sent to a still for regeneration.

Methanation

The residual carbon monoxide and carbon dioxide in the hydrogen product from the absorption process are converted to methane and water vapor over the catalyst in the methanator. The reactions taking place in this reactor are:



These reactions are exothermic and occur in a fixed-bed catalytic reactor at temperatures of 700 °F–800 °F (370 °C–427 °C). The temperature rise across the catalyst bed may be used as an index of the amount of conversion taking place. The temperature rise can occur when treating hydrogen is 74 °C for carbon monoxide and 59 °C for carbon dioxide for each 1 volume percent present in the feed gas. The plant is designed to bypass the methanator if high temperatures occur due to excessive concentration of carbon oxides in the feed. This is carried out to prevent a temperature runaway.

Methanator catalyst contains nickel oxide on an inert carrier. Nickel contents range from 32–52 wt%. The catalyst is activated by reduction to elemental nickel with process gas at conditions approaching normal operation.

In normal use, the catalyst becomes active at about 300 °C. It retains its activity at temperatures up to 816 °C; however, the maximum temperature by design is 450 °C at the outlet. Increasing the pressure will increase the reaction rate due to higher catalyst loading. Usual applications produce a product with less than 5–10 ppm of carbon oxides. The presence of water vapor increases carbon oxides in the product according to reaction equilibrium, whereas increased operating pressure decreases the carbon oxides.

Sulfur will deactivate the catalyst; therefore, catalyst heating and cooling rates should be limited to 50 °C/hr to avoid physical degradation, and rapid depressuring can damage the catalyst by expansion of retained gases in the pores. At temperatures below 150 °C, nickel reacts with carbon monoxide to form highly toxic nickel carbonyl. This reaction will remove nickel from the catalyst and deactivate it. Figure 11.2 shows process flow diagram of the hydrogen production unit.

11.6 Purification of Hydrogen Product

The reformer effluent contains significant quantities of carbon monoxide (CO) and carbon dioxide (CO₂) (on the order of 10 to 12% each), which are removed to increase the hydrogen purity to the desired level of

about 97%. Initially, most of CO are converted to CO₂ in the two-shift converters, and the CO₂ is then reduced to a low level by being absorbed by a lean Sulfinol solution in the Sulfinol absorption column. The column overhead gas contains small quantities of CO (0.37%) and CO₂ (0.10%), which are then reacted with hydrogen in the methanator and converted to methane and water.

The only operating variables of the two-shift converters are the temperature controllers on the high-temperature shift converter gas feed and on the gas feed to the low-temperature shift converter. The optimum inlet temperature to each shift converter has to be determined by trial-and-error adjustments based on evaluation of catalyst bed temperatures and analysis of each effluent gas stream. Since the activity of the shift catalyst gradually decreases during operation, this has to be offset by increasing the inlet temperature as required to maintain optimum carbon monoxide conversion.

The removal of CO₂ from the hydrogen product stream takes place in the Sulfinol absorption column. The design solvent circulation is based on the design feed gas flow, composition and other operating conditions such as temperature and pressure. Considerable deviation from one of these variables can strongly influence the required circulation rate.

1. Changes in the feed gas flow rate require adjustment of the solvent circulation rate. However, proper attention is required to the design turn-down ratio of the plant.
2. The hydrogen dew point of the feed gas determines the minimum lean solvent temperature to prevent condensation of the hydrocarbons.

The higher the feed gas temperature, the higher the temperature of the lean solvent, which has a negative effect on the acid gas equilibria; more solvent circulation is then required for a sufficient driving force for absorption in the bottom of the absorber, and a leaner solvent is required to meet the specifications in the treated gas.

A low temperature can affect the viscosity of the solvent, leading to mass-transfer constraints. A minimum lean solution temperature is 20 °C.

3. A higher acid gas content in the feed gas will require a higher solvent circulation rate to remove all the acid gas, although this can be compensated by the higher acid gas partial pressure in the feed gas.

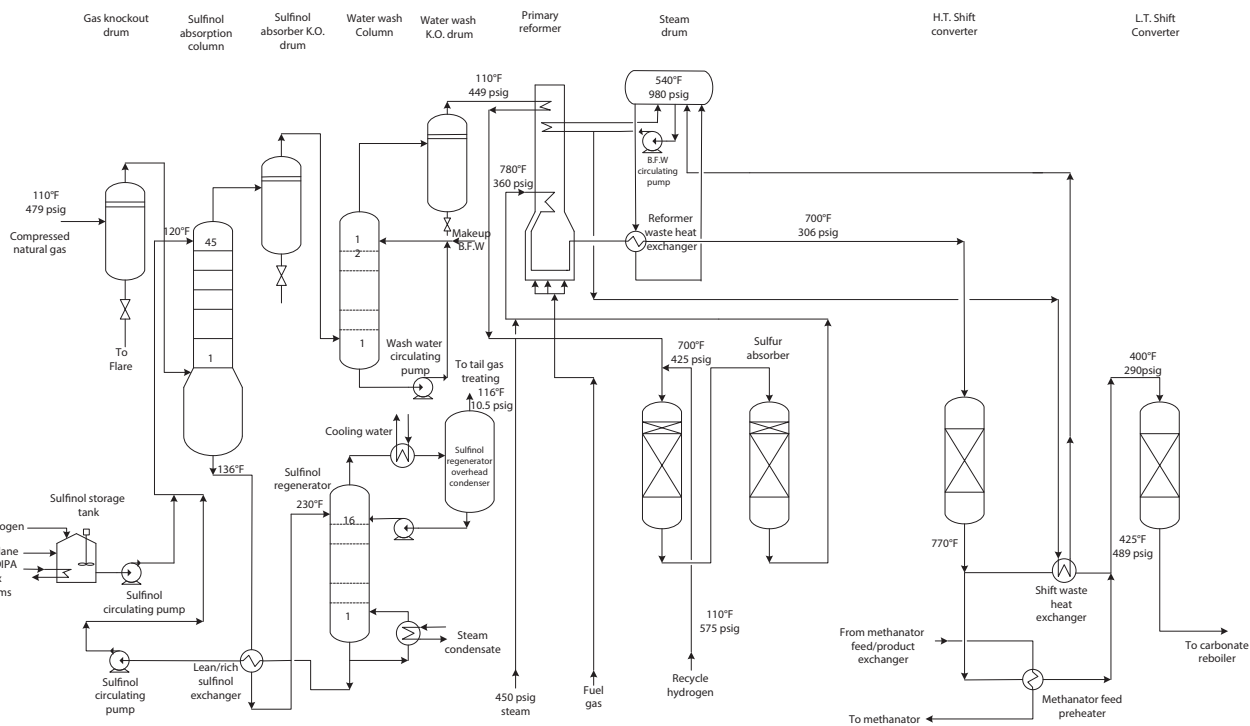


Figure 11.2 Hydrogen plant (reforming and shift conversion). H.T. = high temperature; L.T. – low temperature; B.F.W = boiler feed water.

4. A deviation from the correct solvent circulation rate at constant heat input in the reboiler will show the following effects:

A decrease in the circulation rate will result in a gradual increase in the acid gas content of the treated gas due to an insufficient driving force for absorption, and mass-transfer constraints. Finally, a sharp increase in acid gas content of the treated gas will occur once the maximum absorption capacity of the Sulfinol solvent is exceeded.

An increase in the solvent circulation rate will cause an increase in the acid gas content of the lean solvent as a result of less efficient stripping; consequently, the acid gas content of the treated gas will rise.

RHS and other organic sulfur compounds do not react with the amine, but their removal is based upon the physical solubility in the Sulfinol solution.

A key parameter is the solvent-to-gas ratio; the higher the ratio, the better the removal of mercaptans, etc. The physical solubility is also increased at lower absorption temperatures. These are the tools being used when the required removal of organic sulfur is more stringent compared with the design basis.

The final hydrogen product purification step is achieved by converting the residual CO and CO₂ in the

Sulfinol absorber effluent gas to methane in the methanator. The only operating variable is the temperature controller, which maintains the desired inlet gas temperature at 320 °C. However, the actual inlet temperature is not as critical as the amount of residual CO and CO₂ in the inlet gas, since the conversion reaction is highly exothermic and a sudden increase in CO and/or CO₂ can cause dangerously high temperatures in the methanator that cannot be adequately compensated for by reducing the inlet temperature on the controller. Therefore, continuous monitoring of CO analyzer at the low-temperature shift converter outlet, and CO₂ analyzer on the gas outlet of the water wash column is necessary. An increase on either analyzer should be investigated to prevent temperature runaway of the reactor. Figure 11.3 shows typical chemical reactions in H₂ production.

11.7 Hydrogen Distribution System

Hydrogen is produced in hydrogen manufacturing unit 7000 and Platformer unit 9000 (Figure 5.6).

The hydrogen is consumed predominantly by hydrocracker reaction unit 4000, and then by hydrodealkylation unit 9500, hydrodesulfurization units,

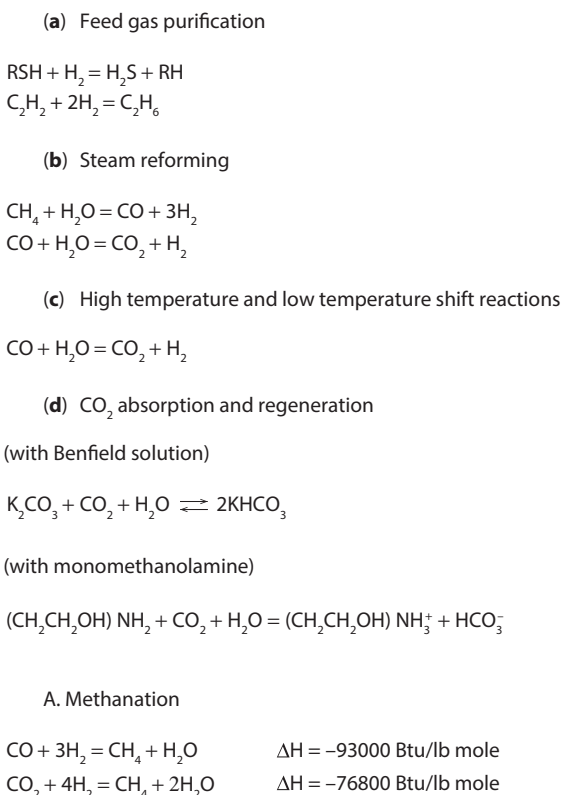


Figure 11.3 Chemical reactions involved in hydrogen production.

2200, 2300 and 2400 and Platformer hydrotreater unit 9100.

The hydrogen from hydrogen manufacturing unit 7000 is sent to fresh gas compressors of hydrocracker reaction unit 4000. The gas is compressed to 149 barg and fed into the discharge of recycle gas compressor. A side draw-off is taken from the third-stage suction vessel at about 63 barg, of which a part is recycled to hydrogen manufacturing unit 700 under flow control. The remainder is fed to the refinery hydrogen header under pressure control.

The tie-in to the refinery hydrogen header is located at the unit limit off take from the refinery header of the gas oil hydrodesulfurizer unit 2400, and the operation is enhanced by feed hydrogen of highest purity.

The header pressure is set at 38 barg and controlled by a pressure controller in the main header. The hydrogen makeup from the Platformer unit 9000 is fed to booster compressor and compressed into the refinery hydrogen header. The remaining consumers are supplied with hydrogen from that header.

Efficiently operating a refinery hydrogen network has been a challenge due to the breadth and complexity of the network. While the efficient use of H₂

represents significant operating cost savings, Picioccio and Zagoria [16] expressed that managing the network on the basis of H₂ losses alone can result in gross errors, as the effect of H₂ on process performance and margin must be managed at the same time. They showed that major improvements can be achieved through H₂ recovery and have found other opportunities to improve H₂ network operations.

11.8 Off-Gas Hydrogen Recovery

Table 11.2 provides a brief description of off-gas recovery processes and Table 11.3 shows hydrogen content of off-gases from a refinery. Hydrogen recovery processes are membranes, adsorption and cryogenics. Each technology has advantages and disadvantages and comparison between these are shown in Table 11.4.

11.9 Pressure Swing Adsorption (PSA) Unit

Pressure swing adsorption (PSA) is an established technology for the separation and purification of a wide range of industrial gases. PSA is safe, reliable and cost effective. In the petroleum refining industry, PSA process is used to produce hydrogen from synthesis gas that is produced by steam-methane reforming, partial oxidation or gasification. While the absorption process produces low purity hydrogen 95–97%, PSA unit produces hydrogen purities above 99%. PSA technology is used to recover H₂ from refinery off gases, to capture CO₂, and to generate O₂ and N₂ gases.

PSA unit employs solid adsorbents in the number of adsorbers where an impure hydrogen stream is purified by separating high-purity hydrogen. The impurities are adsorbed, and regeneration takes place alternatively by depressurization to low pressure and purging with pure hydrogen. Each adsorber operates in the following steps:

- Adsorption
- Depressurization
- Purging
- Pressurization.

The hydrogen removed from the PSA is recovered from the process gas by adsorption of methane, carbon monoxide, carbon dioxide and water vapor on molecular sieves and activated carbon-based adsorbents. The

Table 11.2 Off-gas recovery system.

Off gas recovery process	Process description
Membrane	This consists of pretreatment for removal of entrained liquids; preheat the feed before gas enters the membrane separators and membrane separator configurations. Typical hydrogen purity is 90–98% and could reach 99.9%. Membrane separators are compact bundles of hollow fibres contained in a pressure vessel. The pressurized feed enters the vessel and flows on the outside of the fibers (shell side). Hydrogen permeates selectively through the membranes to the inside of the hollow fibres (tube side), which is at the lower pressure. A common disadvantage of membranes is that hydrogen is produced at pressures much lower than the feed pressure and may require additional recompressing. Off-gas membrane recovery system is given in Table 11.5.
Adsorption	Pressure swing adsorption is commonly used in gas separation and produces hydrogen of high purity 99.9%. However, recoveries are lower than other processes. Feed impurities are less of a problem as compared to membranes. Heavy hydrocarbons pose a difficulty if they are irreversible. If a hydrogen product with a purity of 99% + is required, PSA is an obvious choice. PSA recovery system is shown in Table 11.6.
Cryogenic	Cryogenic process provides the highest capital cost alternative, and its application has been very limited. It is limited to large capacities when liquids recovery, such as C ₃₊ hydrocarbon cut, is required. Cryogenic unit has the ability to deliver separate hydrocarbon by-product streams. Cryogenic separation is expensive for small capacities. Recoveries of NGL are given in Table 11.7.

(Sources: Zagoria [12], Abrardo and Khurana [13], Patel *et al.* [14]).

Table 11.3 Typical hydrogen content of various off-gases.

Off-gas source	Typical hydrogen, concentration, %vol
Naphtha reformer	65–90
Hydroprocessing	
High pressure	75–90
Low pressure	50–75
Fluid catalytic cracking	10–20
Toluene HAD	50–60
Ethylene manufacture	70–90
Methanol manufacture	70–90

(Source: Abrardo, J. M. and V. Khurana [13]).

Table 11.4 Hydrogen recovery and purification technology characteristics.

Characteristics	Membrane	Adsorption	Cryogenics
Hydrogen purity (%)	<95	99.9+	95–99
Hydrogen recovery (%)	<90	75–90	90–98
Hydrogen product pressure	<<feed pressure	Feed pressure	Variable
By – products available	No	No	Yes
Feed pressure (psig)	250–1,800	150–800	250–500

(Source: Patel, *et al.* [14]).

Table 11.5 Refinery off-gas membrane recovery systems.

	Case 1	Case 2
Off-gas sources	Hydrocracker HP purge	Hydrocracker LP purge
Feed pressure, psig	1,800	270
Feed flow (MMscfd)	32	10.2
Feed composition (mol%)		
H ₂	74.6	61.9
C ₁		21.1
C ₂		10.0
C ₃ ⁺	7.0	
H ₂ product pressure, psig		17.7
H ₂ product flow (MMscfd)	2.3	6.5
H ₂ recovery (%)	90.9	1.4
H ₂ product purity (mol%)	94.3	450

(Source: Abrardo, J. M. and V. Khurana [13]).

feed is operated at high pressure, and the absorbent attracts the impurities where a pure hydrogen product streams exits from the adsorber. Subsequently, the adsorbent is regenerated by bringing the adsorber down to the lowest pressure. The adsorbent releases the impurities which are disposed of as purge gas.

Table 11.6 Refinery off-gas PSA recovery systems.

	Case 1	Case 2
Feed pressure, psig	395	310
Feed flow (MMscfd)	20	65
Feed composition (mol%)		
H ₂	80	66.8
N ₂		3.2
C ₁	15	16.5
C ₂	3	7.8
C ₃ ⁺	2	5.2
H ₂ O		0.5
H ₂ product pressure, psig	385	300
H ₂ product flow (MMscfd)	13.5	37.4
H ₂ recovery (%)	86	88
H ₂ product purity (mol%)	99.9	99.9

(Source: Abrardo, J. M. and V. Khurana [13]).

Table 11.7 Cryogenic hydrogen purification with NGL recovery.

Feed pressure, psig	260
Feed flow (MMscfd)	56.8
Feed composition (mol%)	
H ₂	65.3
N ₂	2.3
C ₁	24.2
C ₂	5.4
C ₃ ⁺	2.9
H ₂ product pressure, psig	135
H ₂ product flow (MMscfd)	35.6
H ₂ recovery (%)	92.3
H ₂ product purity (mol%)	96.1
C ₃ ⁺ product pressure, psig	30
C ₃ ⁺ recovery (%)	78.8

(Source: Abrardo, J. M. and V. Khurana [13]).

Operating Principles

Pressure swing adsorption process involves a physical binding of gas molecules to a solid adsorbent material. The adsorbent material can be a combination of activated carbon, silica gel, carbon molecular sieves and zeolites. The attractive forces between the gas molecules and the adsorbent material depend on the gas component, the type of adsorbent material, the partial pressure of the gas component and the operating temperature. Highly volatile compounds with low

polarity such as hydrogen and helium are essentially not adsorbed at all compounds to molecules such as CO₂, CO and N₂ and hydrocarbons. Figure 11.4 illustrates the relative forces of various gas molecules with a typical adsorbent material.

The PSA process performs at constant temperature and uses the effect of alternating pressure and partial pressure to perform adsorption and desorption. Since heating or cooling is not required, cycle time can be short (i.e., in few minutes). Furthermore, heat is not required for the regeneration of the adsorbent and changes in temperature are caused only by the heat of adsorption and desorption and by depressurization. This results in an extremely long lifetime of the adsorbent material.

Pressure swing adsorption processes are based upon equilibrium considerations, where a typical equilibrium isotherm is illustrated in Figure 11.5. Adsorption isotherms indicate the relationship between partial pressure of a gas molecule and its equilibrium loading on the adsorbent material at a given temperature. Adsorption is at high pressure (10–40 bar) until equilibrium loading is reached, and at this instance, the adsorbent material must be regenerated in order to avoid impurity breakthrough to the product. This regeneration is performed by reducing the pressure to slightly atmospheric pressure, resulting in a corresponding reduction in equilibrium loading. This process results in the adsorption of impurities on the adsorbent material, which are then desorbed and the adsorbent material is regenerated. The amount of impurities removed from a gas stream in one cycle corresponds to the difference in the adsorption-to-desorption loading [2]. Figure 11.6 shows a simplified schematic diagram of hydrogen pressure swing adsorption as the main process steps include adsorption, desorption and pressure equalization. During adsorption, the feed gas is fed upward through the adsorber vessels. The impurities, including water, heavy hydrocarbons, light hydrocarbons, carbon monoxide and nitrogen are selectively adsorbed in the vessel from the bottom to the top. High-purity hydrogen flows to the product line.

Typical Operating Conditions

Flow, kg/hour	34,515
Molecular weight	14.2
Temperature, °C	Up to 860
Pressure, kg _f /cm ² g	24.6

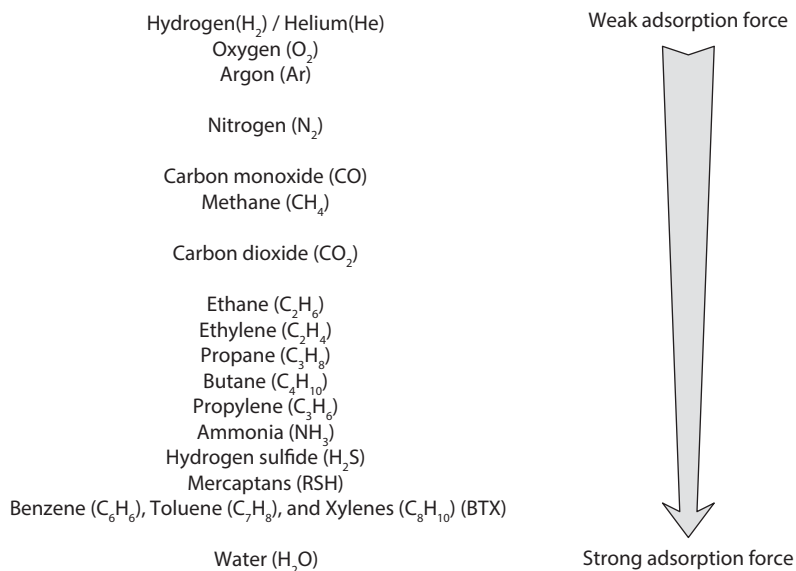


Figure 11.4 Highly volatile compounds with low polarity are not adsorbed onto the adsorbent material in a pressure swing adsorption process.

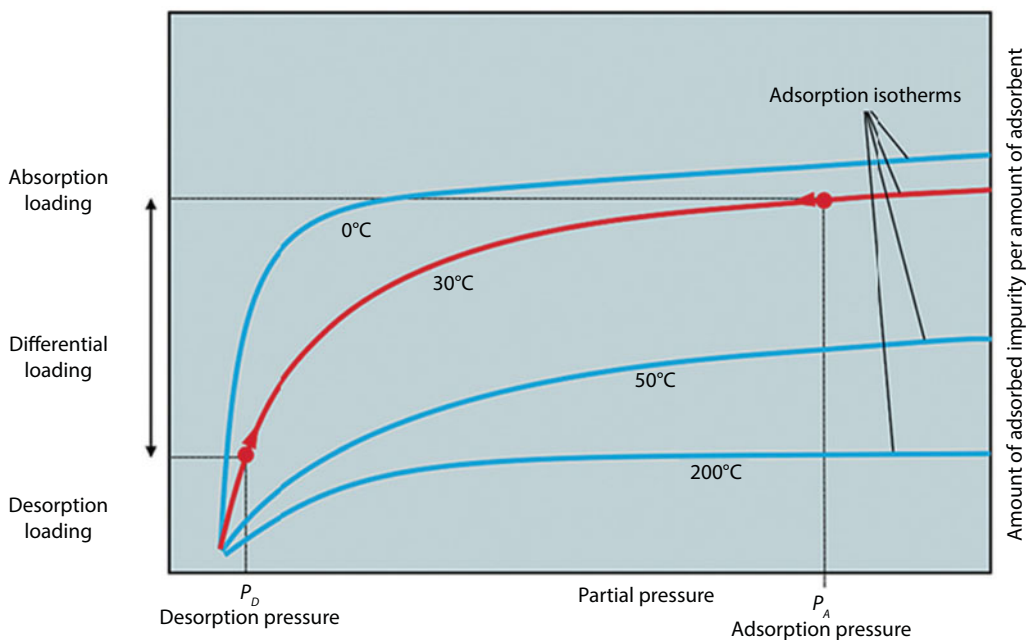


Figure 11.5 Adsorption isotherms show the relationship between partial pressure of a gas molecule and its equilibrium loading on the adsorbent material at a given temperature. (Source: Keller, Tobias, and Goutam Shahani, PSA Technology: Beyond Hydrogen Purification, Chemical Engineering, CE Focus on Petroleum Refining & Petrochemicals, 2017).

Pressure swing Adsorption (PSA) Outlet

Type	Design
Composition	% vol
Hydrogen	99.9
Methane	Balance

Nitrogen max, ppmV	< 50
Carbon monoxide/carbon dioxide max. ppmV	< 20
Chlorides max., ppm V	Nil
Water max. ppm V	< 50
Total	100.0

(Source: Indra Deo Mall, *Petroleum Refining Technology*, CBS Publishers & Distributors Pvt Ltd., 2015).

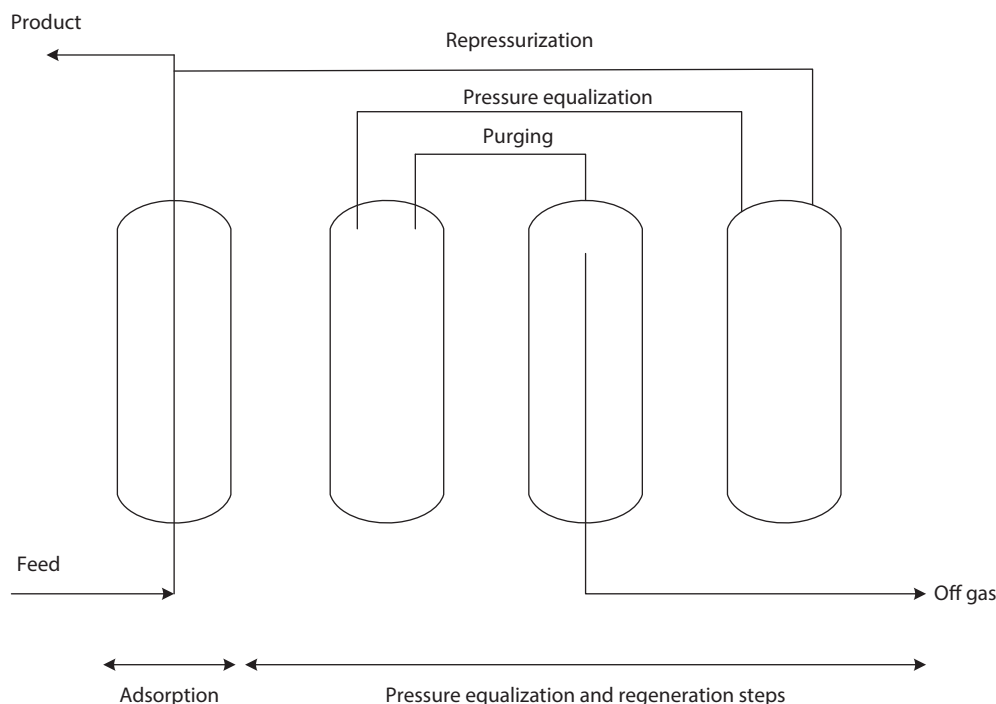


Figure 11.6 The main process steps of a typical PSA process, including adsorption, desorption and pressure equalization. (Source: Keller, Tobias, and Goutam Shahani, PSA Technology: Beyond Hydrogen Purification, *Chemical Engineering*, CE Focus on Petroleum Refining & Petrochemicals, 2017).

The advantages of pressure swing adsorption are [15]:

- High purity of hydrogen is 99.9%. Conventional units with amine treating and methanation seldom achieve purity that is higher than 98%.
- Purity in conventional units depends upon the quantity of inerts in the feed. The PSA process yields over 99.9% purity regardless of feed quality.
- The conventional process requires severe steam reforming operating conditions in the reformer furnace to get over 97% H₂ purity. The PSA process allows less severe operating conditions and still achieves a high purity. However the purge stream contains 3–8% unreacted methane.
- High efficiency of hydrogen recovery is up to 90%.
- PSA process is more reliable and requires less capital cost.
- Operating costs in the PSA process are lower due to lower energy expenditures. The PSA purge is used as furnace fuel. Considerable amount of steam is generated that can be exported to other units in the refinery.

11.10 Refinery Hydrogen Management

The management of hydrogen in the refinery can significantly impact the operating costs, refinery margin and carbon dioxide emission. Therefore, managing hydrogen distribution more effectively has been found to improve refinery profitability by millions of dollars and often enables refiners to avoid the capital cost of new hydrogen production. Many off-gas streams from refinery and petrochemical processes contain hydrogen that can vary from 50–90% to as low as 10%. Recovery of hydrogen from the off-gas is also very viable and acquiring importance. Table 11.8 shows comparison of off-gas hydrogen recovery and purification processes.

An important aspect of enhancing the yield of hydrogen is using and optimizing high performance catalysts in various stages of hydrogen production, such as:

- Hydrodesulfurization using catalysts and adsorbent.
- Two-stage steam reforming; pre-reforming and steam reforming stages.
- High, medium and low shifts.

Table 11.8 Comparing off gas hydrogen recovery and purification processes.

Features	Adsorption	Membranes	Cryogenics
H ₂ purity (%)	99.9+	< 95	95–99
H ₂ recovery (%)	75–90	< 95	90–98
Feed pressure	Feed pressure	<< feed pressure	Variable
Feed H ₂ content	> 40%	> 25–50%	> 10%
By-product available	No	No	Yes
Feed pressure, barg	10–50	15–125	15–35

(Source: Patel, N., Ludwig, K., and P. Morris, Insert Flexibility into Your Hydrogen Network, Part. 1, p 75, *Hydrocarbon Processing*, Sept. 2005).

Table 11.9 Overview of hydrogen network improvement options

	Daily operating decisions	Engineering improvement
Hydrogen plant	Steam to carbon ratio Temperature	Catalyst, revamp for different feed debottlenecks
Catalytic reformer	Severity Feed properties	Catalyst change Reduce pressure
Distribution network	Optimize matching of producers and consumers	New compression control system improvement
H ₂ purification	Feed rate trade off vs. purity Recovery vs. capacity	Debottleneck revamp for different feed compositions New purifier
Hydroprocessing	Make-up source Purge flow H ₂ partial pressure	Vapor compression Add H ₂ S scrubbing.

(Source: Zagoria, A., Refinery Hydrogen Management – The Big Picture. *Hydrocarbon Processing*, p 41, Feb. 2003).

Furthermore, high-performance catalysts and high-activity catalysts can increase both the hydrogen supply and energy efficiency in a refinery. Catalysts as HDMax, ReforMax, Shiftmax and Meth series developed by Clariant Technology have been shown to improve the performance in energy efficiency and hydrogen output keeping operating cost down.

A refinery hydrogen management program should be organized to meet the required objectives and hydrogen network in a typical refinery includes the following steps:

- Maximize hydrogen utilization through increased recovery.
- Decouple catalytic reformer operation with hydrogen production needs.
- Take advantage of higher hydrogen purity with specific consumers.
- Reduce cost of hydrogen production.
- Improve hydrogen production reliability.
- Expand hydrogen production.

- Evaluate refinery hydrogen plant shut down economics.

Hydrogen pinch techniques have been developed for analyzing hydrogen resources in refinery complexes. This identifies the best opportunities for off-gas reuse and purification and helps in quantifying the minimum size of new hydrogen production facilities. Hydrogen pinch technology can be used to define the best hydrogen solution while taking into account the following factors:

- Compression requirements.
- Potential for reuse of off-gas streams.
- Potential for hydrogen purification.
- Confirming existing network headers.

Table 11.9 shows an overview of hydrogen network improvement options, as network operating decisions can affect the bottom line and profitability of the refinery.

11.11 Hydrogen Pinch Studies

Increasing demand for hydrogen in the refinery and chemical plants has resulted in better hydrogen network synthesis. Hydrogen Pinch is analogous to the heat integration pinch, and is intended to offer structured analysis techniques and methodologies to optimize and to improve a hydrogen network. Typically, a refinery or chemical plant can be divided into hydrogen producing units (e.g., catalytic reformer hydrogen plant, ethylene plant) and hydrogen consuming units (hydrotreaters, hydrocrackers and isomerization). Some hydrogen consumers, however, also produce hydrogen because their purge streams usually contain a significant amount of hydrogen with an appropriate value. A hydrogen pinch study involves the following:

- Data collection/data extraction.
- Targeting
- Results: Conclusions/recommendations
- Further evaluations/engineering of results.

Figure 11.7 shows a typical hydrogen consumer, where the actual hydrogen stream to the reactor is shown, and as such the actual hydrogen sink is a mixture of both, the hydrogen make-up stream and the recycle stream. Similarly, the actual hydrogen purges; the hydrogen sources are the actual streams from the (high-pressure and low-pressure) separators. By adding up all hydrogen supplies a

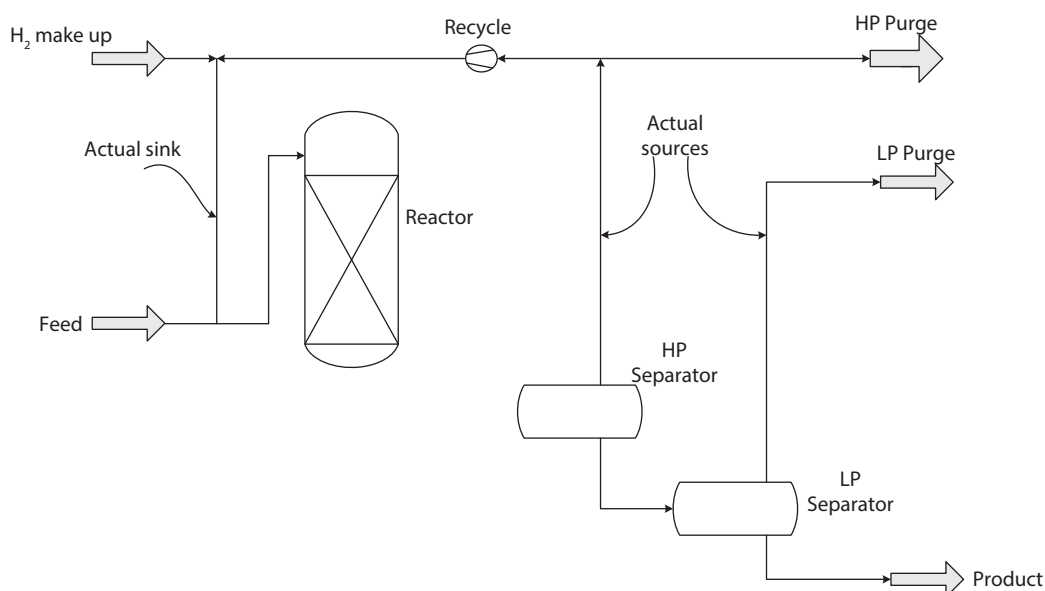


Figure 11.7 A hydrogen consumer process flow diagram.

hydrogen supply composite curve (similar to the Hot Composite Curve) can be constructed. These are all hydrogen producers as well as the purges i.e., the actual sources from the consumers. Correspondingly, a hydrogen demand composite curve (similar to the cold composite curve) can be constructed from the actual hydrogen sinks (make-up plus recycle) of the respective hydrogen consumers. By plotting these two curves together, the hydrogen composite curves of a refinery are obtained as shown in Figure 11.8. These curves form the basis for a hydrogen surplus cascade. This is constructed by calculating the respective area, which is equivalent to the amount of hydrogen surplus at that level. These are then plotted in a diagram as lines, as the purpose is to minimize the hydrogen pinch, which implies a minimal hydrogen consumption of the overall refinery and minimal hydrogen waste into the fuel gas system.

Hydrogen pinch analysis builds on the technique developed to analyze energy systems. A rigorous and systematic approach incorporates all the elements of hydrogen use and supply along with the impact on process yield. Where the refinery plans to spend capital to increase hydrogen capacity, options to reduce or even eliminate this investment form a critical part of the analysis. The technology allows finding a solution to the complex and highly interdependent issues involved with hydrogen system management. Figure 11.9 shows the relationship between the key parameters in hydrogen pinch analysis [17]. When these parameters are

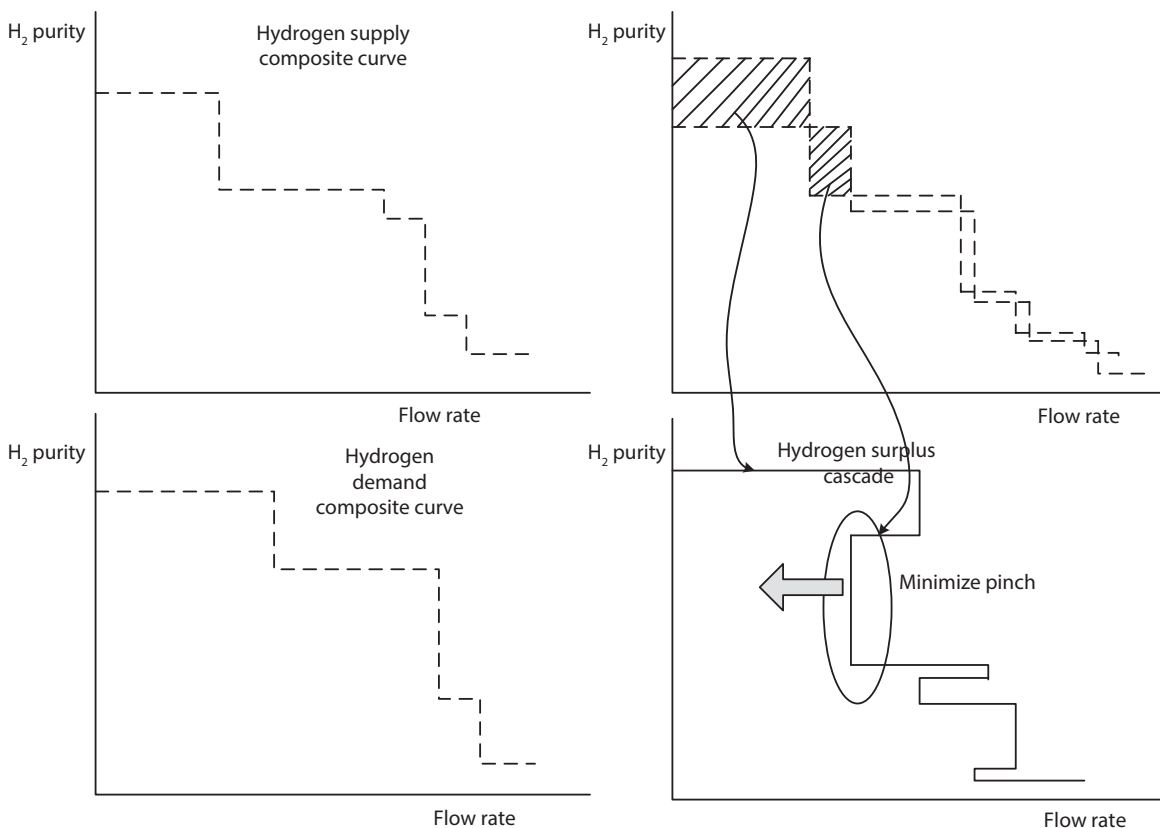


Figure 11.8 The hydrogen composite curves.

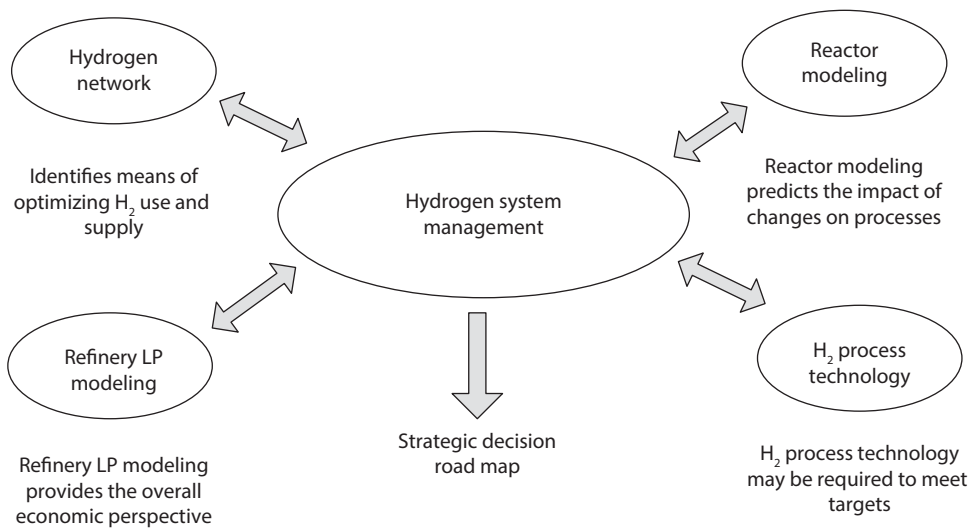


Figure 11.9 Hydrogen pinch overview [17].

addressed simultaneously, then the refinery be maximized economically and profitably.

A given hydrogen network, may include hydrogen purification such as a Pressure Swing Adsorption unit, a membrane unit or cryogenic separation. Such

a purifier may be appropriately placed above the pinch, because a higher purity will push the pinch point to the right. This presents an opportunity for further reduction in the make-up, but may also cause the pinch point to shift. A purifier can also be

appropriately placed across the pinch, because this will open up the pinch. It is not appropriate to place it below the pinch, because this will only result in a higher purity fuel gas.

The first study in this field by Towler *et al.* [3] focused on cost and added value referred to as value composites, based on interactions with the refinery linear programming (LP) model for operational planning. The value composite curve is developed to provide insight into economic trade-offs that affect the hydrogen management problem in the network. However, this approach did not account for the physical constraints that influence the design of the hydrogen network. Alves and Towler [4] proposed the concept of hydrogen surplus to locate the minimum utility target in a new hydrogen distribution network.

Alves [5] developed a procedure for assessing the available hydrogen resources on a site by applying the hydrogen pinch analysis. It involves constructing hydrogen composite curves accounting for the demands and sources of hydrogen on a site in terms of stream purity versus flow rate. This is used to construct hydrogen surplus diagram similar to the grand composite curve (GCC) in heat integration. These instruments allow engineers to find the system hydrogen pinch and set targets for hydrogen recovery, production and import by a refinery. This methodology has been improved by Hallele and Liu [6], accounting for pressure as a factor, and thus making the best use of the existing compressors in the refinery. Their improved method accounts for important costs and trade-offs including production, compressors, fuel and piping costs.

Agrawal and Shenoy [7] presented a unified conceptual approach employing the nearest neighbors algorithm to design hydrogen networks, which evolve to account for the pressure constraints imposed by compressors or improved by regeneration through purification processes such as pressure-swing adsorption. Recently, Wei *et al.* [8] proposed a modified hydrogen network model, which allows for marginal changes in hydrogen purity and hydrogen partial pressure in hydroprocessor reactors, and Jla [9] has provided a more detailed description of the mathematical modeling approach. Roozbeh *et al.* [10] provided a design hierarchy, heuristics and guidelines for the design of oil refineries hydrogen network, based upon pinch technology and extending the heat integration concepts to mass integration. They were able to maximize the amount of hydrogen recovered across the site during the design, and thus provide opportunity for refineries

to make more efficient use of hydrogen at considerable savings on total cost. Nelson and Liu [11] presented an automated Excel spreadsheet that enables the user to quickly and accurately identify the hydrogen purity at the pinch point and the minimum flow rates of hydrogen utilities without an iterative graphical construction. The method employed in the spreadsheet minimizes fresh hydrogen consumption while maximizing hydrogen recovery and reuse in petroleum refinery and petrochemical industries.

References

1. Philips, G., Hydrogen: Innovative Business Solutions. *Petroleum Technology Quarterly*, 2000
2. Keller, Tobias, and Goutam Shahani, PSA Technology: Beyond Hydrogen Purification, *Chemical Engineering*, CE Focus on Petroleum Refining & Petrochemicals, 2017.
3. Towler, G. P., Mann, R., Serriere, A. J., and C. M. D. Gabande, "Refinery hydrogen management: cost analysis of chemically integrated facilities", *Ind. Eng. Chem. Res.*, Vol. 35, No.7, pp 2378–2388, May 1996.
4. Alves, J. J. and G. P. Towler, "Analysis of Refinery Hydrogen Distribution Systems", *Ind. Eng. Chem. Res.* 41, pp 5759–5769, 2002.
5. Alves, J. J., "Analysis and design of refinery hydrogen distribution systems", PhD Thesis, Dept. of Process Integration, University of Manchester, 1999.
6. Hallele, N. and F. Liu, "Refinery hydrogen management for clean fuels production", *Advances in Environmental Research*, 6, pp 81–98, 2001.
7. Agrawal, V. and U. V. Shenoy, "Unified Conceptual Approach to Targeting and Design of Water and Hydrogen Networks", *AIChEJ.*, vol. 52, No. 3, pp 1071–1082, March, 2006.
8. Wei, Z, J., Yuhang, L., Zhang, Nan., and K. Guy, "Optimising and revamping a refinery hydrogen network", *Revamps Petroleum Technology Quarterly*, pp 37–46, 2011.
9. Jla, N., "Refinery hydrogen network optimization with improved hydroprocessor modeling", PhD Thesis, Centre for Process Integration, University of Manchester, 2010.
10. Roozbeh, S., *et al.*, "Design of Oil Refineries Hydrogen Network Using Process Integration Principles", *Iran J. Chem. Chem. Eng.*, vol. 27, No. 4, 2008.
11. Nelson, A. M., and Y.A. Liu, Hydrogen pinch analysis made easy, *Chem. Eng.*, pp 56–61 June, 2008.
12. Zagoria, A., Refinery Hydrogen Management – The Big Picture. *Hydrocarbon Processing*, p 41, Feb., 2003.
13. Abrardo, J. M. and V. Khurana, Hydrogen Technologies to Meet Refiner's Future Needs, *Hydrocarbon Processing*, p 44, Feb., 1995.

14. Patel, N, Ludwig, K., and P. Morris, Insert Flexibility into Your Hydrogen Network, part 1. p 75, *Hydrocarbon Processing*, Sept. 2005.
15. Fahim, M. A., Al-Shahhaf, T. A., and A. S. El-Kilani, *Fundamentals of Petroleum Refining*, Elsevier, 2010.
16. Picioccio, R., and A. Zagoria, Options for improving hydrogen network operations, National Petrochemical & Refining Association, 107th NPRA Annual Meeting, p. 8, March 22/23, 2009. This is now renamed as American Fuel & Petrochemical Manufacturers (AFPM).
17. Bealing, C. and G. Ricci, Using an integrated approach conserves energy and hydrogen., *Hydrocarbon Processing*, <http://www.hydrocarbonprocessing.com/Article/2599522/>, 12/10/2003.

12

Gas Processing and Acid Gas Removal

12.1 Introduction

The increasing environmental concerns of gas emissions in the refinery have become the pertinent issues facing the refinery industry. Acid gases in a refinery are carbon dioxide (CO_2) and hydrogen sulfide (H_2S). Sour gas is a gas that contains sulfur compounds such as mercaptans (RSH) and carbonyl sulfide (COS). Gas with only carbon dioxide is referred to as sweet gas. Although the main gas treatment processes emit H_2O and CO_2 , CO_2 is considered an undesirable product because of its impact in global warming. CO_2 is a corrosive material, non-combustible and entraps the solar radiation if released to the atmosphere thereby impacting the warming of the earth's atmosphere. H_2S is highly toxic and 1.18 times heavier than air. It may accumulate in dangerous concentrations in vessels, tanks, valve pits and drains. H_2S concentration must be less than 6 mg/m^3 (43 ppm) to prevent the effect of corrosion in process equipment.

Sulfur compounds (hydrogen sulfide, mercaptans, disulfides, thiophenes) are present in natural gas and crude oil, and their presence even in small quantities poses problems in various conversion processes:

corrosion problems, catalyst poisoning, inhibition of catalytic conversion processes, and environmental concerns. Consequently, larger amounts of hydrogen sulfide require to be processed, and sulfur recovery has been an area of interest and intense development by refiners. Major sources of sulfur compounds are gas and liquid sweetening and sour water stripping, and the level of sulfur in crude oil has steadily increased due to the increased use of heavier crude with high-sulfur content. However, future refining configuration and cost of gasoline, diesel and other fuels will be greatly influenced by sulfur content of the crude and the required sulfur specifications as refineries are compelled to produce ultra-low-sulfur gasoline and sulfur diesel. There are recovery units converting hydrogen sulfide into elemental sulfur.

The sulfur content in crude oil varies widely worldwide and depends upon source and quality of the crude being processed. Emission of sulfur has been one of the major environmental problems in recent years, and refiners have been forced to incur extremely high costs due to governments' compliance as Occupational Safety and Health Administration (OSHA), Environmental Protection Agency (EPA), Health and Safety Executive

in the U.K. (HSE) to meet the sulfur emission standards, which are becoming more stringent. Sulfur removal and recovery processes are:

- Hydrotreating
- Hydrodesulfurization.
- Amine absorption of H₂S
- Merox sweetening
- Shell Claus Off-gas Treating (SCOT)

Because of increasing environmental concerns, OSHA, EPA, HSE and other governmental organizations worldwide have imposed stringent limits on sulfur levels in the fuel, to achieve a limit of 100 ppm from 330–350 ppm sulfur. Sulfur output in the refinery takes place as one of the following [25]:

- Sulfur emission into the atmosphere in the form of SO₂.
- Sulfur recovery in sulfur recovery unit.
- Sulfur content in the finished products.

Typical sulfur distributions in a refinery are:

- Product sulfur (41%)
- Sulfur in various products (58%)
- Sulfur emission (1%)

Figure 12.1 shows sources and recovery of sulfur, 12.1 illustrates some of the hydrotreating processes for improving the quality of fuel and lubricants; Figure 12.2 shows the major hydrotreatment processes.

Hydroprocessing has evolved as the principal technology in modern refinery facility. These processes

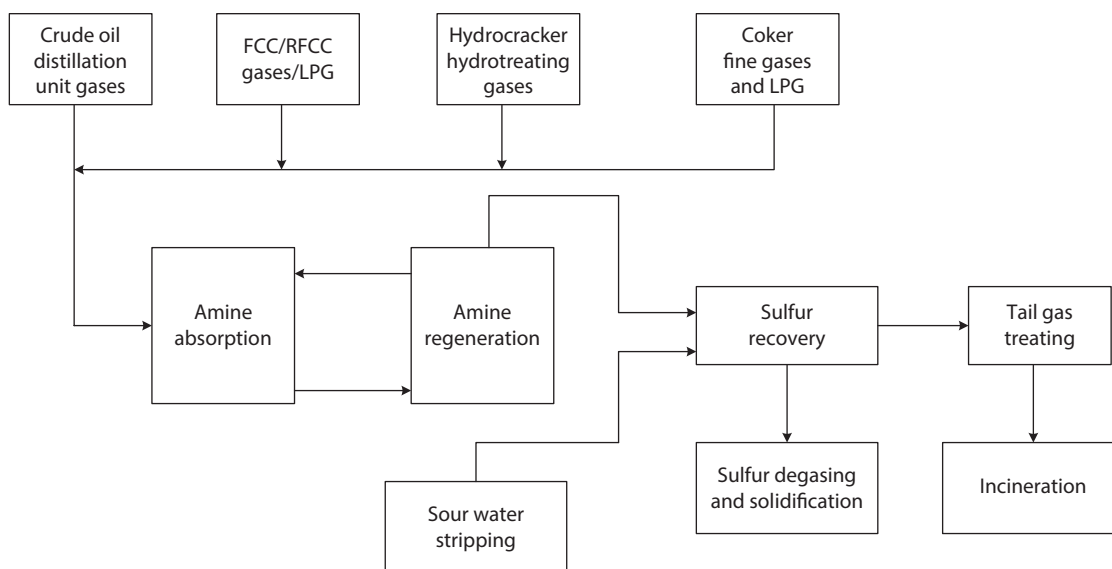


Figure 12.1 Major sources of sulfur and recovery processes in refinery facility [26].

Table 12.1 Hydrotreating processes for improvement of quality product stream.

Hydrotreating process	Improvement
Naphtha hydrotreating for catalytic reforming	Removal of sulfur, nitrogen, metals.
Kerosene hydrotreating	Reduces mercaptans, sulfur, aromatics and improves smoke point.
Diesel hydrotreating	Reduces mercaptans, sulfur, aromatics and improves cetane number, thermal stability.
Vacuum gas oil hydrotreating for FCC	Removal of sulfur, nitrogen, metals.
FCC gasoline hydrotreating	Reduces sulfur content and produces ultralow sulfur FCC gasoline with maximum retention of olefins and octane.
Lube hydrotreating	Reduces sulfur, Conradson carbon and improves color, oxidation stability.
Pyrolysis gasoline hydrotreating	Removal of sulfur, nitrogen, metals.

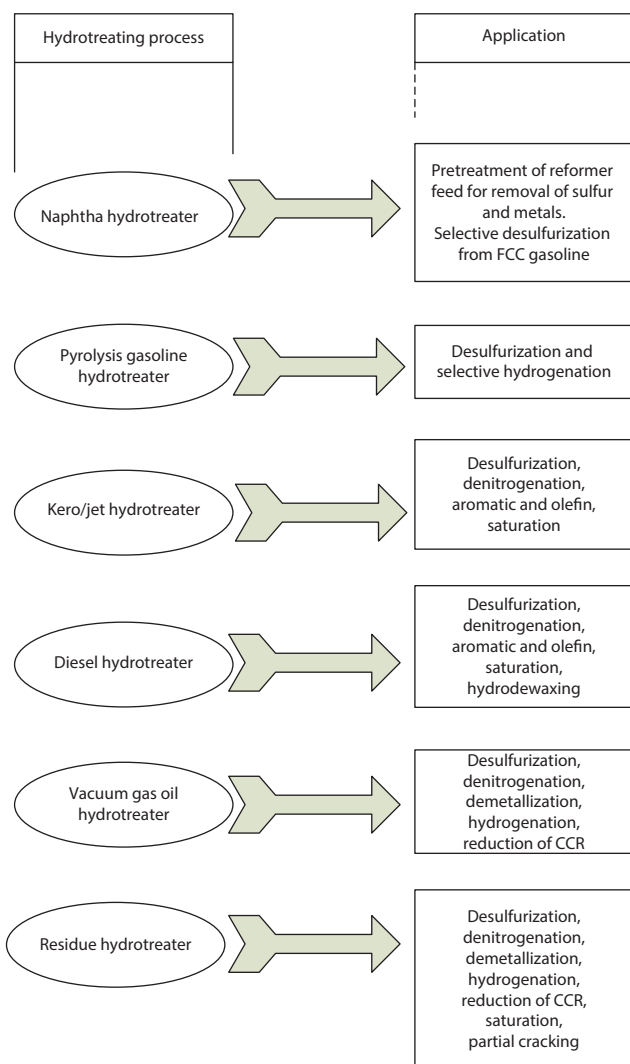


Figure 12.2 Hydrotreating process in the refinery.

are employed to meet the challenges due to increasing impurities and high-sulfur contents present in the crude, which can adversely impact the distillation column, the auxiliary equipment as heat exchangers, pumps and compressors, as well reduction in catalyst activity and product quality, and for meeting the stringent environmental standards of the fuel and lubricants. Some of the major commercial hydrotreating processes are shown in Table 12.2.

12.2 Diesel Hydrodesulfurization (DHDS)

Governmental organizations such as OSHA, EPA, and HSE have imposed stringent specifications upon sulfur content of diesel produced in petroleum refineries. The

hydrodesulfurization process is extensively employed in reducing sulfur content in the diesel to produce the required specification required. The diesel/gas oil from the various processing units is treated to remove the sulfur content. These are [26]:

- Straight-run gas oil.
- Vacuum diesel.
- Visbreaker gas oil
- Total cycle oil.

Process: The feedstocks are blended from sources as straight run or cracked units (e.g., thermal gas, visbreaker); the sulfur and nitrogen contents depend on the type of crudes, and the cracked products are characterized by the presence of unsaturated hydrocarbons (olefins, diolefins and aromatics). The following reactions occur during the hydrotreating process:

- Conversion of organic sulfur compounds to hydrogen sulfide.
- Conversion of organic nitrogen compounds to ammonia
- Conversion of organic oxygen compounds to water
- Saturation of olefin compounds.
- Conversion of halides to hydrogen halides.
- Removal of organometallic compounds.

This process is to remove 90% sulfur in feed diesel using hydrogen from catalytic reformer or hydrogen generation units. The required level of desulfurization is achieved by hydrotreating over a specially selected catalyst. The presence of olefins or diolefins requires additional bed in the upstream of the desulfurization bed. The desulfurization section consists of:

Reaction section: This consists of fresh feed pretreatment, feed preheat, make-up hydrogen system, recycle hydrogen section, reactor effluent cooling and water wash.

Fractionation section: This separates the sour gas and naphtha from the diesel product. A typical flow diagram of the process is shown in Figure 12.3, and Table 12.5 shows characteristics of feed before and after desulfurization. Figure 12.5 is a photograph of Ultra-low-sulfur diesel unit (ULSD).

12.3 Hydrotreating Reactions

The major hydrotreating reactions are:

- Desulfurization process, where sulfur compounds (mercaptans, sulfide, disulfide,

Table 12.2 Commercial hydrotreating processes.

Hydrotreating process	Description
Axen ultralow sulfur diesel (ULSD)	Produces ultralow sulfur diesel and high cetane and improved color diesel from wide range of distillate.
CD hydro and CDHDS (CDTECH)	The process selectively desulfurizes the FCC gasoline with minimum octane loss with maximum retention of olefins and octane. The light, middle and heavy cut naphtha is treated separately under optimal conditions.
Chevron Lummus Global Ebullated Bed Bottom of the barrel hydroconversion (LC – fining) process	LC-Fining processes heavy oil feeds are hydrogenated and converted to a wide spectrum of lighter, more valuable product such as naphtha, light and middle distillates and atmospheric and vacuum gas oils. The LC-Fining residual hydroconversion processes most difficult, heavy, and lower-value hydrocarbon streams (petroleum residuals, heavy oils from tar sands, shale oils, solvent-refined coal extracts, etc.) at conversion levels of 80 percent and higher. The process is accomplished at relatively high temperatures and high pressures in the presence of hydrogen and a residual conversion catalyst to hydrogenate the products and prevent polymerization of the free radicals as cracking reactions proceed. The catalyst consists of a combination of metals that promote hydrogenation (e.g., cobalt and molybdenum, or nickel and molybdenum) deposited on an alumina base. Table 12.3 shows a typical range of operating parameters of the process.
Exxon Hydrotreating Technology	Exxon hydrotreating technology processes wide variety of feedstocks for removal of sulfur, nitrogen, metals, saturation of olefins, diolefins, aromatics and improvement of product quality. Hydrofining: Naphtha and distillate hydrotreating. DODD: Diesel oil deep desulfurization. GO-fining: Gas oil hydrotreating, Resid-fining: Atmospheric or vacuum residue hydrotreating, Hydrofining is ideally suited for the production of reformulated gasoline. GO-fining and resid-fining are suited for the treatment of feeds to catalytic cracking for removal of Conradson carbon, metals, sulfur and nitrogen and saturation of multi-ring aromatics. Some of the recent developments to meet all current and possible future premium diesel requirements are ULSD HDS: Ultra deep hydrodesulfurization HDHC: Heavy distillate mild hydrocracking, MAXSAT: High activity aromatic saturation process, CPI: Diesel cloud point improvement.
Haldor – Topsoe hydrotreating process	The process has a wide range of applications, including the purification of naphtha, distillates, and residue as well as the deep desulfurization and color improvement of diesel fuel and the pre-treatment of FCC and hydrocracker feedstocks. Ultra-low-sulfur diesel (ULSD) (Figure 12.4 shows two reactors in diesel upgrading) is designed to produce diesel 5–50 wppm using special catalyst. Both low-pressure reactor and high-pressure reactor configuration are available.
Howe-baker Engineers	The process is used for the reduction of sulfur, nitrogen, and metals content of naphtha, kerosene, diesel or gas oil streams.
IFP Hyvahl process	The process upgrades or converts high metal atmospheric or vacuum residues using fixed bed and dual catalyst hydrotreating process.
RDS/VRDS hydrotreating process (Chevron Research Technology Co.)	The process upgrades residual oil by removing impurities and cracking heavy molecules in the feed to produce lighter product oils. The process involves hydrotreatment of atmospheric or vacuum residuum feedstocks to reduce sulfur, nitrogen, metals and asphaltene and carbon residue contents resulting in lighter products while reducing the viscosity of the unconverted bottoms. Catalyst: Small, extruded pellets made from an alumina base containing active metals cobalt, nickel, molybdenum and other more proprietary materials, size, 0.8–1.3 mm.
UOP unionfining	UOP unionfining process involves hydrotreatment of petroleum and chemical feedstocks. The reaction involves hydrodesulfurization, hydrodenitritification, saturation of olefins, and saturation of aromatics. Catalyst, CoO or NiO 1–6% wt, MoO ₃ 6–25% wt, Al ₂ O ₃ balance.

(Continued)

Table 12.2 Cont.

Hydrotreating process	Description
UOP RCD unionfining	<p>RCD unionfining reduces the sulfur, nitrogen, Conradson carbon, asphaltene, and organometallic contents of heavier residue derived feedstocks for downstream processing units such as hydrocracker, fluidized catalytic cracker, resid catalytic cracker and coker. The conversion reaction path in the process is from asphaltenes to resins, resins to aromatics, and aromatics to saturates [3].</p> <p><i>Saturates:</i> Fully soluble in pentane; this fraction contains all the saturates.</p> <p><i>Aromatics:</i> Soluble in pentane; this fraction contains all the saturates.</p> <p><i>Aromatics:</i> Soluble in pentane and separated by chromatography: this fraction contains neutral aromatics.</p> <p><i>Resins:</i> Soluble in pentane and absorb on clay; this fraction contains polar aromatics; acids, and bases.</p> <p><i>Asphaltenes:</i> Those that are insoluble in pentane (pentane insolubles) and those that are insoluble in heptane. (heptane insolubles); the weight percent of pentane insoluble is always greater than the weight percent of heptane insolubles.</p> <p>The process provides desulfurization, denitrification, and demetallization of reduced crude, vacuum-tower bottoms or deasphalted oil (DAO). The process uses fixed bed catalytic reactor that operates at moderate temperatures and under moderate to high hydrogen partial pressure. SOR temperature, 330–355°C. For a specific feedstock and catalyst package, the degree of demetallization, desulfurization, and conversion increases with the increasing severity of the process. The operating variables are pressure, recycle-gas rate, space velocity and temperature (Table 12.4).</p>
UOP SRC uniflex process	UOP SRC uniflex process is a high conversion residue hydroprocessing process for the production of gas oil conversion unit feedstock, distillates and naphtha.
UOP unisar process for saturation of aromatics	The process saturates the aromatics in naphtha, kerosene and diesel feedstocks using highly active noble-metal catalysts on either an amorphous or molecular sieve support under mild conditions (temperature, 205–270 °C; pressure 3.5–8.28 bara; space velocity 1.0–5.0 vol/vol. hr). The yields are high, and hydrogen consumption is largely limited to the desired reactions. The process produces low-aromatics diesel with excellent color and color stability, reduction of the aromatic content of solvent stocks to meet requirements for air pollution control, production of cyclohexane from benzene, and cetane number improvement in diesel fuels.

(Source: *Refining processes*, 1998 [2008; Kokayeff, Gillis, Gowdy, Gupta,])

Table 12.3 Typical range of operating parameters of LC-Fining Process [1].

Reactor temperature	400–450°C (750–840°F)
Reactor pressure	100–200 atm (1500–3000 lb/in ² gage)
Conversion, vol % 525°C + (975°F +)	40–92 percent +
Hydrogen partial pressure	70–170 atm (1100–2500 lb/in ² absolute)
Hydrogen consumption	120–340 N m ³ /m ³ (700–2000 SCFB)
Desulfurization	60–95 percent
Demetallization	70–98 percent
CCR reduction	40–75 percent

Table 12.4 Typical hydrotreating Operating Conditions [2].

Operating conditions	Naphtha	Middle distillate	Light gas oil*	Heavy gas oil
LHSV	1.0–5.0	1.0–4.0	0.7–1.5	0.75–2.0
H ₂ /HC ratio, N m ³ /mm ³ (SCF/B)	50 (300)	135 (800)	255 (1500)	337 (2000)
H ₂ partial pressure, kg/cm ² (psia)	14 (200)	38 (400)	49 (700)	55 (800)
SOR temperature, °C (°F)	290 (555)	330 (625)	355 (670)	355 (670)

Note: LHSV = Liquid hourly space velocity, N = standard temperature and pressure, SCFB = standard cubic feet per barrel.

*Conditions to desulfurize light gas oil to ULSD specifications (< 10 wt ppm sulfur).

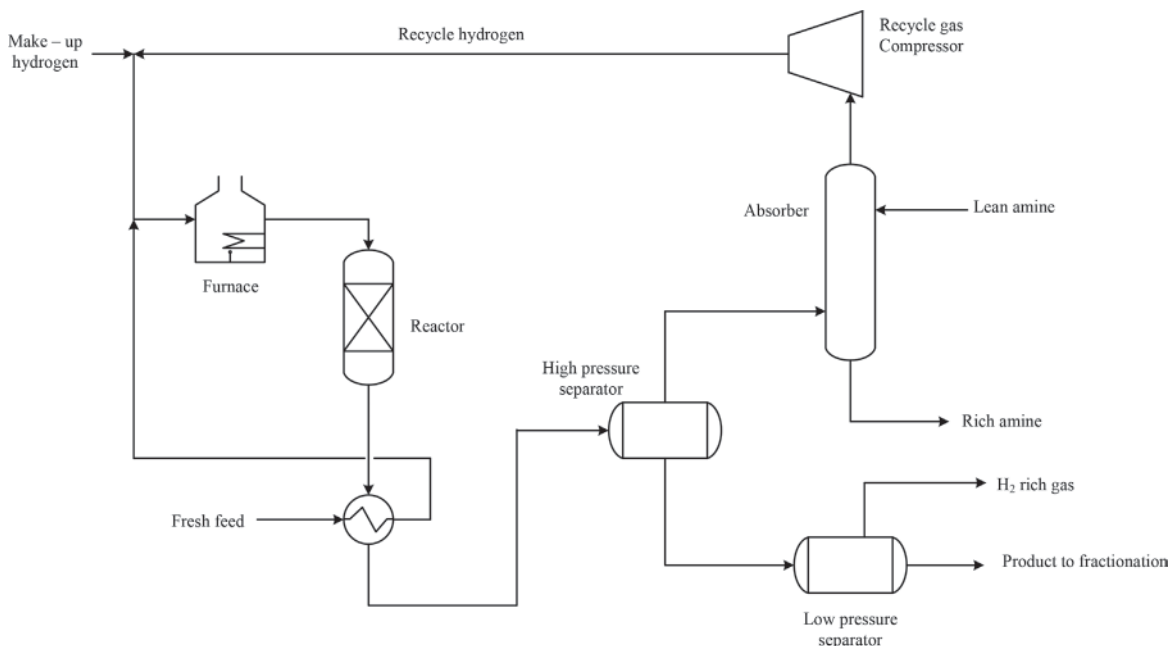


Figure 12.3 Process flow diagram of diesel hydrodesulfurization unit.

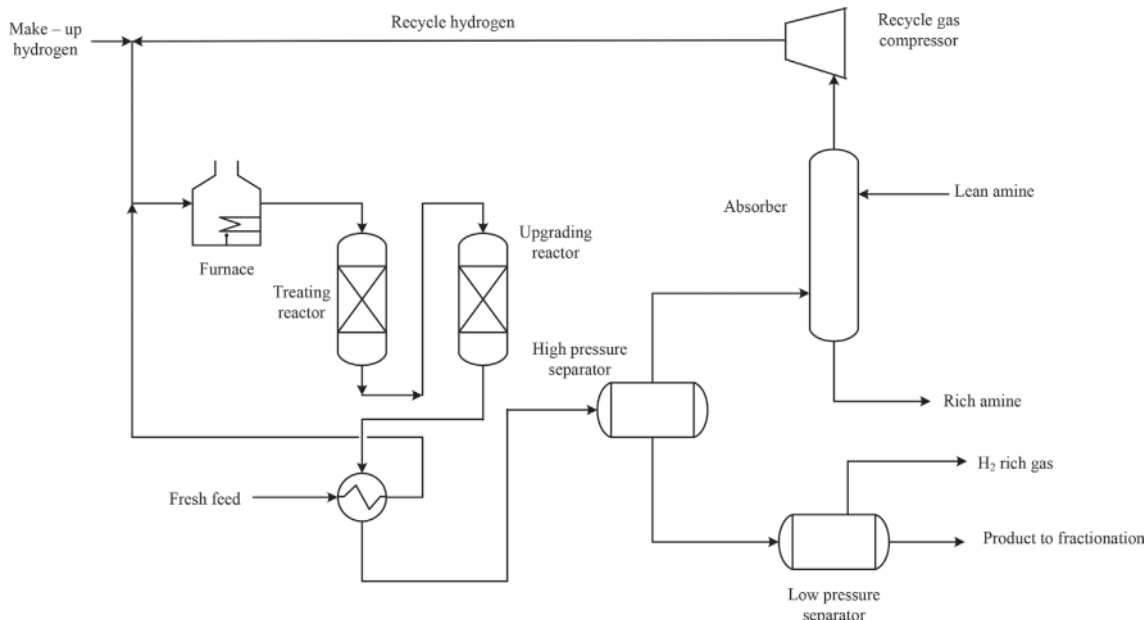


Figure 12.4 Process flow diagram of diesel hydrodesulfurization with treating and upgrading reactors for diesel upgrading.

Table 12.5 Typical characteristics of feed before and after desulfurization process [5].

Properties	Feedstock components						
	GO (Plt. 1)	GO (Plt 15)	LVGO (Plt 15)	SPO blend	LCO - FCCU	HCO - FCCU	Blended feedstock
Sp. Gravity	0.8532	0.8572	0.8929	0.9016	0.8055	0.9205	0.869
Total sulfur (% wt)	1.5	1.5	2.6	2.1	0.4	3.3	1.86
Bromine no. (g/100g)	< 2	< 2	< 2	< 2	46	22	8
Metals (ppm,wt)							< 1
Cetane index ASTM D976	52.6	52	44.9	45	22.3	31.9	48.8
Flash point (°C)							36*
Aniline point (°C)	75.5	74.5	71	72	28.5*	28.5*	
Nitrogen (ppm, wt)	300*	300*	300*	400*	700*	700*	402

*Values estimated as basis

Properties	Diesel product	
Start – of – run	End – of – run	
Sp. Gravity	0.852	0.852
ASTM D86 50% (oC)	306	308
ASTM D86 90% (°C)	378	378
Sulfur (wt, ppm)	2,000 max.	2,000 max.
Water content (wt, ppm)	< 135	< 135
Nitrogen (wt, ppm)	285 max.	285 max.
Flash point (°C)	At least identical to feed	
Cetane index ASTM D976	52.9	52.9
Bromine number (g/100g)	< 1	< 1
Pour point, (°C)	Same as feed	
Color	Same as feed	

**Figure 12.5** A typical Ultra-low-sulfur diesel unit (ULSD), with a fixed-bed reactor on the right.

thiophenes and benzothiophenes, etc.) are converted to hydrogen sulfide using Ni/Co and molybdenum catalyst.

- Denitrification in which organic nitrogen compounds (3-methylpyridine, quinoline, 3-methylisoquinoline, pyrrole, indole, carbazole) are converted to ammonia.
- Conversion of organic oxygen compounds (naphthenic acids) to water.
- Conversion of halides to hydrogen halides
- Demetallization removal of organometallic compounds
- Saturation of olefins
- Saturation of aromatics

The main reaction in the desulfurization process is the removal of sulfur compounds in the form of hydrogen sulfide (H_2S), and the degree of desulfurization varies from feed to feed with nearly complete removal to about 50–70% for heavier residual materials. Kokayeff [4] showed the degree of removing the sulfur from compounds in order of increasing difficulty as:

Thiophenol > ethyl mercaptan > diphenyl sulfide > 3 – methyl – 1 – butanethiol > diethyl sulfide > dipropylsulfide > diisoamylsulfide > thiophene.

12.4 Gas Processing

Gas processing or treating may be defined as removal of hydrogen sulfide (H_2S) and carbon dioxide (CO_2) from a feedstock. H_2S must be removed for health reasons and to prevent corrosion. Natural gas pipeline specifications require no more than $\frac{1}{4}$ grain/100 SCF. This is equivalent to 4 ppmv or 7 ppmw (for a 0.65 specific gravity gas). By contrast, the human nose can detect 0.13 ppmv and the threshold limit value for prolonged exposure is 10 ppmv.

CO_2 must be removed to prevent corrosion, and because it lowers the heating value of natural gas. Some processes allow most of CO_2 to “slip” while selectively removing H_2S . Where CO_2 can be tolerated downstream, it is more economical to remove only H_2S . H_2S can be selectively removed in order to enrich the H_2S content of the acid gas stream feeding a sulfur recovery unit. However, in such cases, the concentration of CO_2 should be retained below 80% in the acid gas feed. Some of the reasons for selective H_2S removal are:

- H_2S enrichment for sulfur recovery.
- Economical design (capital and operating costs).
- Special cases such as energy recovery.

12.4.1 Natural Gas

Natural gas is a mixture of hydrocarbon and non-hydrocarbon gases found in porous rock formations below the earth’s surface, usually with crude oil. The main component of natural gases is methane together with small amounts of heavier hydrocarbons and some non-hydrocarbon gases such as carbon dioxide (CO_2), helium (He), hydrogen sulfide (H_2S) and nitrogen (N_2). It can further be classified as:

Associated gas: the gas occurs in the free state in contact with a large crude oil reservoir. Associated gas usually contains less methane than non-associated

gas; but it is richer in other higher molecular weight hydrocarbons.

Non-associated gas: the gas remains in the free state, associated with minimal amounts of crude oil. It is richer in methane and leaner in other higher molecular weight hydrocarbons and than associated gas.

Dissolved gas: the pressure in the oil reservoir is high, so the gas remains in solution. It is released as a result of drilling.

Natural gas can be in other ways classified as: dry or lean gas which contains mostly methane (CH_4); wet gas which contains considerable quantities of higher hydrocarbons; sour gas which contains much H_2S ; sweet gas, which contains a little H_2S ; residue gas from which higher paraffins have been extracted and finally casing head gas, which is derived from an oil well by extraction at the surface.

The non-hydrocarbon components of natural gas can be classified as:

- Diluents such as N_2 , CO_2 and water vapor.
- Contaminants such as H_2S and other sulfur compounds.

The diluents, being non-combustible, reduce the heating value of the gas as fuel and thus can be used as fillers to reduce its heat content. The contaminants can cause harmful effects and can also affect transportation and production equipment plants.

Natural Gas Liquids (NGL): Liquid hydrocarbon mixtures extracted from natural gas. They fractionate into ethane (C_2H_6), propane (C_3H_8) and butane (C_4H_{10}). Liquefied petroleum gas (LPG) containing mainly C_3H_8 and C_4H_{10} , is the main commercial product made from natural gas and it can be stored and handled as a liquid at ambient temperatures and moderate pressures.

Natural gasoline is a mixture of hydrocarbons extracted from natural gas containing mostly pentanes and some heavier hydrocarbons. Initially, liquefied petroleum gas and natural gasoline were used solely as fuels, but recently liquefied petroleum gas has been used as a source of propane and butane for the petrochemical industry. Natural gasoline is also used as a source of butanes (C_4H_{10}), isobutanes (iC_4H_{10}), pentanes (C_5H_{12}) and isopentanes (iC_5H_{12}) as feedstocks for reforming, alkylation, synthetic rubber manufacture, etc. Table 12.6 shows the general composition of natural gas.

Table 12.6 Composition of natural gas.*

Component	Dry gas (mol%)	Sour gas (mol%)	Gas condensate(mol%)
CO ₂	–	6.7	0.7
H ₂ S	–	3.3	–
N ₂ and air	0.8	–	–
CH ₄	95.8	84.0	74.5
C ₂ H ₆	2.9	3.6	8.3
C ₃ H ₈	0.4	1.0	4.7
iC ₄ H ₁₀	0.1	0.3	0.9
nC ₄ H ₁₀	Trace	0.4	1.9
iC ₅ H ₁₂	–	–	0.8
nC ₅ H ₁₂	–	–	0.6
C ₆ H ₁₄	–	0.7	1.3
C ₇ H ₁₆	–	–	6.3

*Sometimes natural gas contains some helium content 0–0.5 mol %
 (Source: Majoorana, S. K. B., *Modern Petroleum Chemistry*, Kannatheri Publications, 2003)

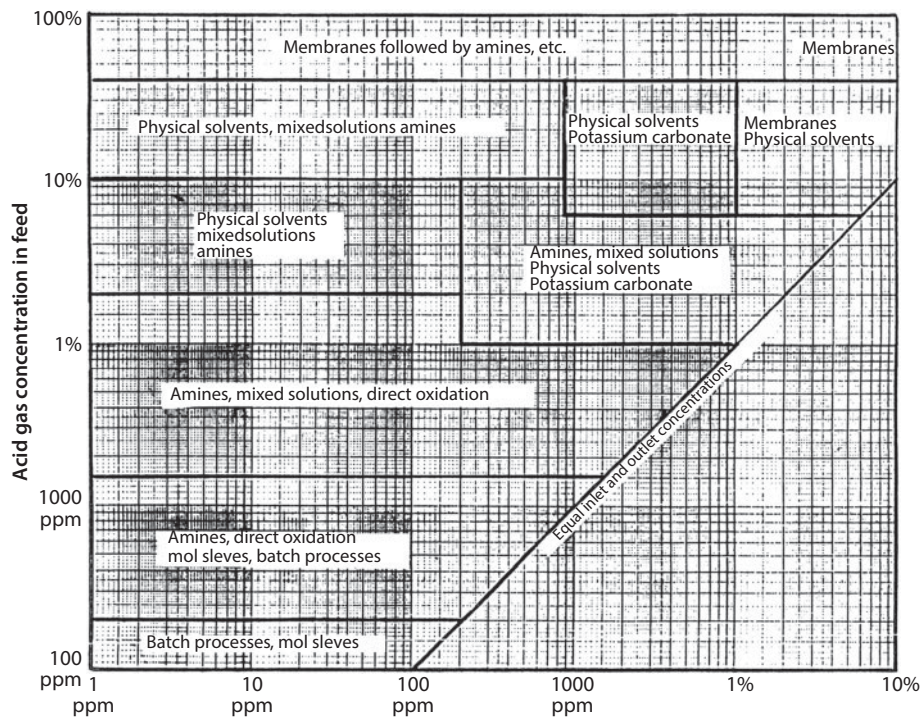


Figure 12.6 Guide for selecting gas sweetening processes (Source: Branan, Carl, R., *Rules of Thumb for Chemical Engineers*, Gulf Publishing Co., 1994).

12.4.2 Gas Processing Methods

There are many gas processing technologies as described in *Hydrocarbon Processing* magazine and handbook (see: www.HydrocarbonProcessing.com). The main process types are:

- Reaction type: Monoethanolamine (MEA), diethanolamine (DEA), methyldiethanolamine (MDEA), diglycoamine (DGA).
- Physical solvent type: Fluor solvents (propylene carbonate), Selenol
- Physical/chemical type: Sulfinol.

- Carbonate type: Potassium carbonate.
- Solution batch type: Lo-Cat, Chemsweet
- Bed batch type: Iron Sponge, Molecular sieve.

Figure 12.6 provides a guideline for selecting gas processes.

12.4.3 Reaction Gas Processes

The amines (MEA, DEA, MDEA and DGA) are the most popular treating solutions under the following conditions:

- Low acid and gas partial pressures (product of system pressure and concentration of acid gases H_2S and CO_2 in the feed) of roughly 50 psia and below.
- Low acid gas concentrations in the product of roughly 4–8 ppmv (0.25–0.5 grains/100 scf).
- Heavier hydrocarbons present (provide better filtration for DGA).
- For CO_2 removal with no H_2S , a CO_2 partial pressure of 10–15 psi [24].

Among the amines, MEA is preferred for low contactor pressures and stringent acid gas specifications such as H_2S well below 0.25 grains/100 scf, and CO_2 as low as 100 ppmv. MEA is degraded by carbonyl sulfide (COS) and carbon disulfide (CS_2) with the reactions being only partially reversible with a reclaimer. (The reclaimer helps remove degradation products from the solution and also aids in the removal of suspended solids, acids and iron compounds. Reclaimer operation is a semi-continuous batch operation, where it is filled with hot amine solution and if necessary, soda ash is added.)

DEA is preferred when the total system pressure is > 500 psi or where pipeline quality gas is not required. The 0.25 grains/100 scf constraint is more difficult to reach with DEA. COS and CS_2 have few detrimental effects on DEA. The process flow scheme for DEA plants resembles the MEA process; however, the advantages and disadvantages of DEA as compared to MEA are:

- The mole/mole loading typically used with DEA (0.35–1.3 mole/mole) is much higher than those used (0.3–0.4) for MEA.
- Because DEA does not form significant amount of non-regenerable degradation products, a reclaimer is not required.

- DEA is a secondary amine, and so is chemically weaker than MEA, hence less heat is required to strip the amine solution.
- DEA is typically used for refinery and manufactured gas streams that have COS and CS_2 present.

MDEA is preferred for selective H_2S removal and lack of degradation from COS and CS_2 .

DGA is preferred for cold climates and high (50–70 wt %) solution strength for economy. The freezing point for 50% DGA solution is $-30^\circ F$. By comparison, solution strength for MEA is 15–25 wt%, and for DEA, 25–35 wt%. Because of the high amine degradation rate DGA systems require reclaiming to remove the degradation product.

MDEA is a tertiary amine which is used to selectively remove H_2S to levels required by pipeline specifications at moderate to high pressure, if increased concentration of CO_2 in the residue gas does not cause problems. Some of the advantages of selective removal of H_2S are:

- Smaller amine regeneration plants are needed.
- Reduced solution flow rates resulting from a reduction in the amount of acid gas removed.
- Enriched H_2S concentrations in the acid gas resulting in reduced problems in sulfur recovery.

H_2S removal from gaseous hydrocarbons effluents is achieved by means of a continuous absorption/regeneration process using a 25 wt% diethanolamine (DEA) and Table 12.7 shows the relative effectiveness of these solvents. UniSim software program (Acid - Gas Sweetening.usc) is a simulation for treating a sour gas with DEA solution.

12.4.4 Sweetening Process

Table 12.8 illustrates the commercial sweetening processes.

12.4.5 MEROX Process

The Merox process is most widely used technology in treating petroleum fractions to remove mercaptan sulfur (RSH) or to convert mercaptan sulfur to disulfides (Merox sweetening). It is employed to treat a wide range of liquids such as LPG, natural-gas liquid (NGL), naphtha, gasoline, kerosene, jet fuels and heating oils. It can be used to treat gases such as natural gas, refinery gas and synthesis gas in conjunction with conventional pretreatment and posttreatment processes.

Table 12.7 Effectiveness of the treatment of amine solvents in H₂S removal.

Capacity	DEA < MEA < MDEA < DGA
Effectiveness of the various gas treating amines in the removal of COS.	MDEA < DEA < MEA < DGA
Increasing COS removal	Solvent MEA < DGA < DEA < MDEA
Decreasing bar strength	MDEA < DEA < MEA < DGA
Increasing solubility of hydrocarbons.	MEA < DEA < DGA < MDEA

Mercaptans (RSH) occur naturally in crude oils but are also generated from other sulfur compounds during crude oil fractionation and cracking processes. Mercaptans are undesirable in gasoline because of their obnoxious odor and their tendency to hydrolyze, forming toxic and corrosive hydrogen sulfide. The classic tests for mercaptan presence are the “doctor” test and odor threshold. Mercaptans can affect fuel stability with initiation of gum formation, and corrosive environment to form SO₂ during combustion. If they are not removed, malodorous sulfur compounds are formed, which are highly corrosive. Merox process is used in the refinery, which either removes the mercaptans or controls it to less harmful disulfides. Merox process involves two stages, namely: Merox extraction and Merox sweetening. These processes can be used singly or together (Figures 12.7 and 12.8). Generally, Merox treatment can be used in the following ways [5]:

- To improve lead susceptibility of light gasolines (extraction).
- To improve the response of gasoline stocks to oxidation inhibitors added to prevent gum formation during storage (extraction and sweetening).
- To improve odor on all stocks (extraction or sweetening or both).
- To reduce the mercaptan content to meet product specifications requiring a negative doctor test or low mercaptan content (sweetening).
- To reduce the sulfur content of LPG and light naphtha products to meet specification (extraction).
- To reduce the sulfur content of coker or fluid catalytic cracking (FCC) C₃ – C₄ olefins to save on acid consumption in the alkylation operations using these materials as feedstocks or to meet the low-sulfur requirements of sensitive catalysts used in various chemical synthesis processes (extraction).

Merox Extraction

Merox extraction involves the counter-current extraction of mercaptans with caustic soda.

Merox Sweetening

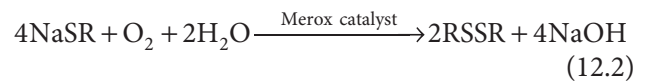
The mercaptans are directly oxidized to disulfide in the presence of a catalyst.

Caustic extraction reaction:

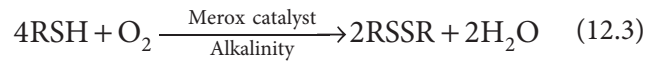


Oil phase Aqueous phase Aqueous phase

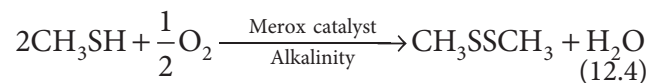
Oxidation:



Aqueous phase Oil phase (insoluble) Aqueous phase



Oil phase Oil phase



The Merox process is used to treat LPG gasoline, naphtha, kerosene and diesel. These fuels are treated using ethanolamine and caustic where mercaptans are removed as they are converted into disulfide in the presence of a catalyst. Table 12.9 provides brief description of these commercial processes, and Table 12.10 summarizes the various applications of the Merox process on different hydrocarbon streams.

12.5 Sulfur Management

Crude oil contains sulfur and nitrogen and during processing, the sulfur and nitrogen are converted principally to hydrogen sulfide (H₂S) and ammonia (NH₃)

Table 12.8 Sweetening processes.

Sweetening process	Description
Sweetening process	This process involves the removal of mercaptans in two steps: Transform mercaptans into mercaptides – caustic and oxidize mercaptans to disulfide.
Caustic wash	Removes H ₂ S mercaptans, thiophenes, thiophenols and naphthenic acids. Mercaptan solubility decreases with increase in molecular weight.
Copper chloride process	Direct oxidation of mercaptans to disulfide in the presence of cupric chloride catalyst $\text{mercaptan} \xrightarrow{\text{Cu}_2\text{Cl}_2} \text{oil} - \text{soluble products}$
Doctor treatment	This process involves the treatment of the sour distillates with alkaline sodium plum bite (doctor solution) in the presence of small amount of free sulfur.
Chelate sweetening (Mobil process for gasoline)	This process involves extraction of mercaptans by NaOH followed by oxidation of mercaptans by oxygen supplied by the chelate. $\text{RSH} + \text{NaOH} \rightarrow \text{RSNa} + \text{H}_2\text{O}$ $\text{RSNa} + \frac{1}{2} \text{O}_2 + \text{H}_2\text{O} \rightarrow \text{RSSR} + \text{NaOH}$ Chelate is a reaction product of N, N' - disalicylidine - 1, 2 propane diamine and cobaltous chloride hexahydrate.
Mercapfining	Mercaptans are converted to disulfide in a fixed bed reactor $\text{Mercaptans} \xrightarrow[\text{catalyst}]{\text{O}_2} \text{disulfide}$
Inhibiting sweetening	The process uses a phenylenediamine type inhibitor, air and caustic to sweeten low mercaptan content gasoline.
Merrichem Technology (Thiolex, Mericat)	The process involves removal of mercaptan by caustic extraction followed by catalytic oxidation in the presence of metal phthaloxyanines oxidation temperature 30–50°C.
Sulfuric acid treating	This process uses weak (80%) or concentrated sulfuric acid (> 100%) for the removal of sulfur compounds. During the treatment, asphaltene is also removed. Sulfuric acid is also used for treating kerosene and lubricating oils.
Napfining process	This process removes H ₂ S, naphthenic acids and mercaptans from kerosene to meet acid number and mercaptan jet fuel specifications. The treatment uses caustic; air and catalyst along with fiber film contactor and an up-flow; catalyst impregnated carbon bed.
Solutizer process	This process involves extraction of mercaptans in alkaline solution (KOH, NaOH) in the presence of promoters such as phenols, carboxylic acids, extractive solution. Solutized is a mixture of KOH and tricresols in water. Dualayer (Mangolia Petroleum Co.): Two-phase mixture of cresols in KOH (43%). Mercasol (Pure oil Co.): Mixed cresols in NaOH. Single phase. Shell solutizer: Potassium isobutyrate in KOH. Tannin solutizer (Mobil & Shell) One percent tannin in solutizer solution.
Mercapsol process	This process involves the extraction of mercaptans using sodium (or potassium) hydroxide together with cresols, naphthenic acids and phenol.
Merox process	The process involves either mercaptans extraction or sweetening.
Caustic Free Merox	Mercaptans are catalytically converted to disulfides, which remain in the hydrocarbon feed using a fixed-bed catalyst. Merox No. 21 catalyst is used for gasoline, and Merox No. 31 catalyst for kerosene respectively. A liquid activator, Merox CF provides an active, selective and stable sweetening environment in the reactor [www.accessengineeringlibrary.com].
Minalk process	Minalk process is suitable for light and heavy gasoline from catalytic cracking and is characterized by minimum use of alkali (3% wt. dilute NaOH). The process involves mixing gasoline with dilute caustic, which goes to a fixed-bed reactor containing activated carbon impregnated with Merox catalyst. The temperature range is 40–50°C and pressure range is 8–20 bar.

(Continued)

Sweetening process	Description
Kerox process	This is a fixed-bed sweetening process suitable for feeds boiling > 140°C containing high molecular weight and branched mercaptans (e.g., kerosene)
HS process	HS process selectively removes H ₂ S from natural gas. The HS process technology combines three principal elements: <ol style="list-style-type: none"> 1. A formulated selective chemical solvent. 2. A unique contactor design. 3. A specially designed selective contactor tray. The solvent is MDEA and the contactor is multistage.
Thiolex/Regen	The process extracts H ₂ S, COS and mercaptans from gases and light liquid hydrocarbons streams, including gasolines, with caustic using fiber film contactor. It is also used to hydrolyze and to remove COS from LPG and propane.
Aminex/Thiolex and Regen ULS	These processes are used to remove COS, H ₂ S and mercaptans from LPG streams with high mercaptans levels and produce treated streams with less than 5 ppm – wt of total sulfur.
Axens' Sulfrex and sweetening processes	These processes eliminate mercaptans by extraction or by their conversion into less aggressive compounds. The extractive Sulfrex process both sweetens and reduces the total sulfur concentration. With its moderate operating conditions of pressure and ambient temperature, this continuous process is ideal for C ₃ , C ₄ , LPG; light gasoline and NGL feeds. The process involves two steps: <p>Overall Sulfrex reaction</p> $4\text{RSH} + \text{O}_2 \rightarrow 2\text{RSSR} + 2\text{H}_2\text{O}$ <p>First step: Extraction</p> $\text{RSH} + \text{NaOH} \rightarrow \text{NaSR} + \text{H}_2\text{O}$ <p>Second step: Oxidation</p> $4\text{NaSH} + 2\text{H}_2\text{O} + \text{O}_2 \rightarrow 2\text{RSSR} + 4\text{NaOH}$ <p>Aqueous phase: hydrocarbon</p>

(Source: Refining Processes, 2001 Gowdy [2], Gills [3], Kokayeff [4]).

and to a lesser extent, organic sulfur compounds, carbonyl sulfide (COS), carbon disulfide (CS₂) and mercaptan (RSH).

Stringent environmental standards and regulations on the emissions of sulfur and nitrogen compounds coupled with low sulfur specifications for petroleum products have resulted in making sulfur management an essential priority in the refineries. This is because today's refineries are processing crudes with higher sulfur contents and also more bottom of the barrel conversion. Therefore, the need for new or revamped sulfur management facilities would increase as demands for cleaner fuel and crude oil slate change.

Sulfur management in the refinery consists of four basic processes. Amine treating process (ATP) removes H₂S from recycle gas stream in hydroprocessing operations and from fuel gas/liquefied petroleum gas (LPG) recovery units. The amine is regenerated in one or more amine regeneration units (ARUs). Sour water strippers (SWSs) remove H₂S and NH₃ from the sour water streams. Sour water is the result of refinery operations using steam in distillation or steam as a means to reduce

hydrocarbon partial pressure or where water injection is used to combat potential corrosion or salt buildup (desalter unit). The sulfur in the acid gas from the amine regeneration unit and the sour water stripper is removed first by a Claus sulfur recovery unit (SRU) that achieves 92–96% of the overall sulfur recovery and then by a tail gas cleanup unit (TGCU) that enhances the overall sulfur recovery to 99.9%. These processes are described in this chapter and simulation exercises are carried out using the UniSim design simulation package.

12.5.1 Sulfur Recovery Processes

Process Description

The acid gas from Shell ADIP process (di-isopropanolamine (DIPA)) unit is routed to the three sulfur recovery units via a common distribution header. The ADIP gas flows into the unit 500 through a feed gas knockout vessel to remove any entrained liquid. Similarly, acid gas from the sour water stripper unit is routed to the SRUs via another distribution header. The sour water

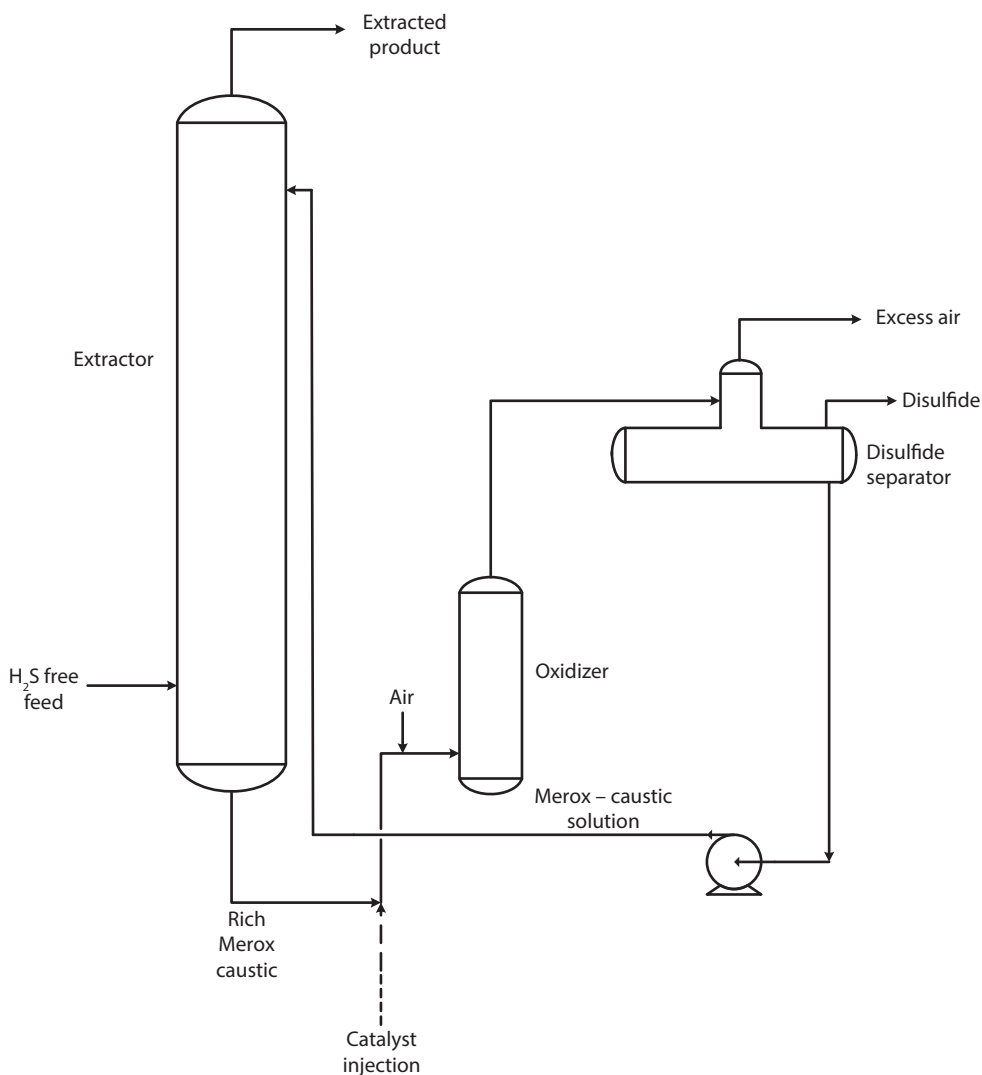


Figure 12.7 Flow diagram of Merox mercaptan-extraction unit.

stripper gas flows into the SRU through the feed gas knockout vessel to remove any entrained liquid.

Water that collects in the knockout vessels drains to two steam propulsion vessels, and the water is returned intermittently to the ADIP unit or the Sour Water Stripper unit from the propulsion drums using the motive force of low-pressure steam. Gas from the knockout vessels is preheated through steam jacketed lines. Each stream is measured and then mixed. The H_2S rich mixture is burned in the main burner. The combustion air is supplied by the main air blower. Ratio controllers set the amount of combustion air sufficient to burn one-third of the H_2S to SO_2 and to complete the combustion of hydrocarbons and ammonia in the feed gas.

Hot gases pass through the main reaction chamber and are cooled in the waste heat boiler. Sulfur vapor

in the gas condenses and drains by gravity through a steam-jacket line and sulfur lock to sulfur pit. A wire-mesh demister is provided at the outlet channel of the waste heat boiler to remove the sulfur mist. About 59% of the sulfur present in the feed is removed in this stage.

Heat is removed by generating low-pressure steam in the waste heat boiler. Boiler feed water is supplied under level control, and the steam pressure is maintained by a pressure controller at the steam header.

The gas leaving the waste heat boiler is reheated in line burner mixing chamber by mixing with hot combustion gases generated in the line burner. The hot process gases flow to the conversion reactor. A temperature control at the inlet of the reactor controls the fuel gas supply to the line burner. Combustion air to the line burner is supplied by the main air blower and is ratio-controlled to the fuel gas flow.

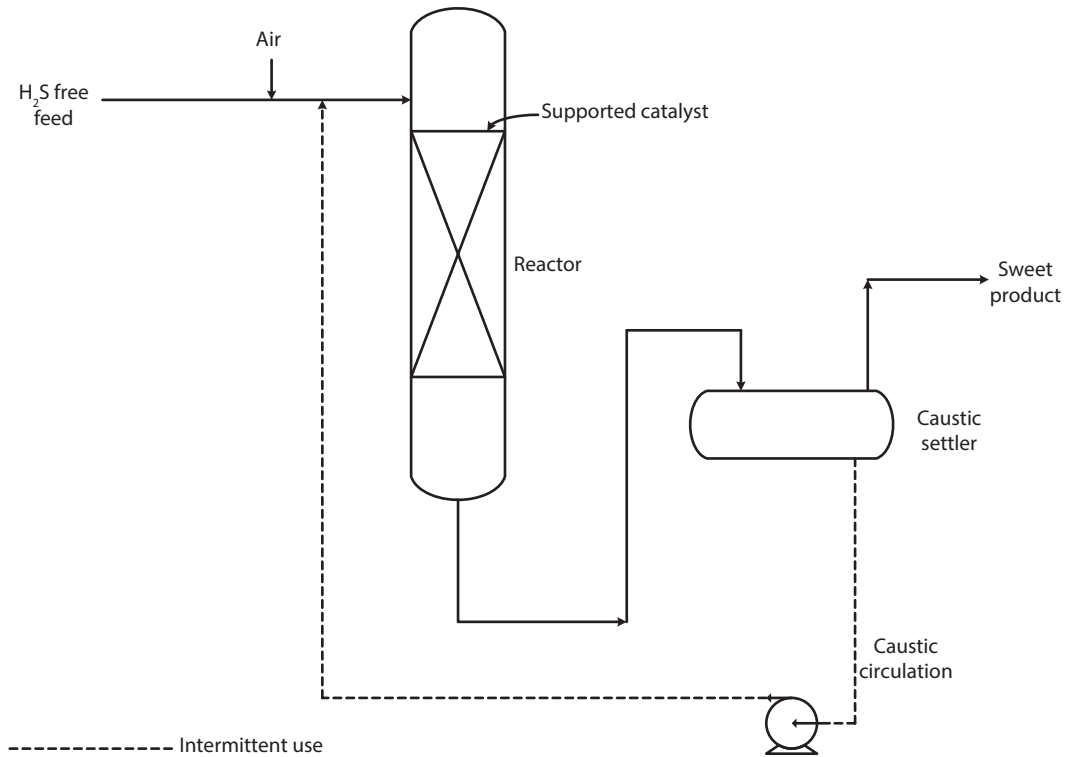


Figure 12.8 Fixed-bed Merox sweetening unit.

Table 12.9 Merox process and description.

Merox process	Description
FCC gasoline Merox unit	FCC gasoline is first washed with caustic to remove thiophenol and is then followed by oxidation of mercaptans to disulfide in the reactor containing charcoal impregnated with Merox catalyst. The treated gasoline is routed to a collector that allows the separation of caustic aqueous phase. This is then sent to an effluent treatment plant. Antioxidant is added to the treated gasoline and then pumped to storage.
Naphtha Merox unit	Visbreaker naphtha is first prewashed with caustic and then sent to an extractor where it is treated with caustic to remove the mercaptans. The rich caustic after separation goes to the caustic regeneration unit. The treated naphtha is mixed with air and then sent to the reactor containing charcoal impregnated with the Merox catalyst where the mercaptans are oxidized to disulfide. The treated product is passed through sand filter and routed to the gasoline pool. The aqueous caustic phase is separated in a collector and then pumped to an effluent treatment plant.
Kerosene/Aviation Turbine Fuel (ATF) Merox unit	Kerosene/ATF mixture is first sent to a coalescing media for separating the water droplets. Then the kerosene/ATF mixture is sent to weak caustic (2–3%) prewash column from where it is sent to the Merox reactor together with air. The reactor contains charcoal impregnated with the Merox catalyst. The product from the reactor goes to a settler where the caustic phase is separated from the hydrocarbon stream. The hydrocarbon is then washed with demineralised water, and then transferred to the salt drier to remove traces of water and finally to clay filters. The treated product is sent to storage tanks. The activated charcoal is regenerated by removing the organic and soap from the pores.
Straight-run and cracked Liquefied Petroleum Gas (LPG) Merox unit	Straight-run liquefied petroleum gas directly from atmospheric (crude distillation) column and cracked LPG is first treated in the amine absorber from which the treated LPG is sent to the prewash in a caustic column, where it is treated with 3% caustic. The gas enters the bottom of an extractor through spargers where 10% caustic solution is used. The overhead gas goes to a caustic settler where the caustic is separated and the treated LPG goes to the LPG storage vessel. The rich caustic is then sent to the oxidizer where sodium mercaptide is oxidized to sodium hydroxide, water and disulfide. The regenerated caustic is separated in the separator and recycled.
Caustic Free Merox	Mercaptans are catalytically converted to disulfides, which remain in the hydrocarbon feed using a fixed-bed catalyst. Merox no. 21 catalyst is used for gasoline, and Merox 31 catalyst for kerosene. Liquid activator, Merox CF provides an active, selective and stable sweetening environment in the reactor. The high activity allows the use of a weak base, ammonia to provide the needed reaction alkalinity. No caustic (NaOH) is required; fresh-caustic costs and the costs of handling and disposing of spent caustic are therefore, not required.

Table 12.10 Merox Process Applications [5].

Hydrocarbon stream	Merox type
Gas	Extraction
LPG	Extraction
Natural gas liquids	Extraction, extraction plus sweetening
Light naphtha	Extraction, liquid-liquid sweetening, Minalk sweetening, caustic-free sweetening
Medium or heavy naphtha	Liquid-liquid sweetening Caustic-free sweetening
Full-boiling range naphtha	Extraction plus sweetening, Minalk sweetening, Fixed-bed sweetening, caustic-free sweetening
Kerosene or jet fuel	Fixed-bed sweetening Caustic-free sweetening
Diesel	Fixed-bed sweetening

The reheated process gases flow downward through a catalyst bed in the conversion reactor. The H_2S reacts with SO_2 to form sulfur. The reaction is exothermic, producing a temperature rise through the catalyst bed. The hot gases are cooled in the sulfur condenser, producing sulfur and generating additional low-pressure steam. The condensed sulfur drains by gravity through a steam-jacketed line and sulfur lock to the sulfur pit.

A wire-mesh diameter is provided at the outlet channel of the sulfur condenser to remove the sulfur mist. Boiler feed water is supplied under a level control. Steam pressure floats on the pressure of the first waste heat boiler and is maintained by the same pressure controller.

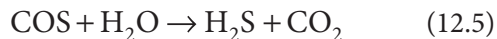
The line burner, reactor and sulfur condenser constitute a catalytic stage for the sulfur recovery. The reheating, conversion in the reactor and sulfur condensation procedure is repeated to ensure at least 95% sulfur recovery.

The tail gases from the coalescer are mixed with sulfur pit vent gases from the steam ejector discharge and are heated by combustion gas generated in the line burner. The hot gases pass through an incinerator mixing chamber and flow to the incinerator reactor. A temperature controller at the inlet to the incinerator reactor controls the fuel gas flow to the line burner. Combustion air is supplied by the incinerator air blower and is ratio-controlled to the fuel gas flow. Excess air (secondary air) added to the incinerator mixing chamber is used to oxidize the sulfur vapor/mist and converts residual H_2S to SO_2 .

The hot gases flow upward through the catalyst bed in the incinerator reactor, oxidizing the sulfur vapor and H_2S components to SO_2 . The resulting hot gases flow to a stack. An emergency spray of boiler feed water is provided for quenching the hot gases in case of temperature upsets. Figure 12.9 shows the process flow diagram of the sulfur recovery unit.

Heating is required to prevent sulfur condensation in the catalyst bed, which can result in catalyst fouling. The catalytic conversion is maximized at lower temperatures, but caution is required to ensure safe operation above the dew point of sulfur.

The condensation heat is used to generate steam at the shell side of the condenser. Before storage, the liquid sulfur stream is degraded to remove any dissolved gases. If the acid gas feed contains COS and or CS_2 , then they are hydrolyzed in the catalytic reactor in the following sequence:



The tail gas from the Claus unit contains combustible components and sulfur compounds (H_2S , H_2 , and CO) is either burned in an incineration unit or further desulfurized in a downstream tail gas clean-up unit (TGCU). A typical Claus process with two catalytic stages produces 97% of the sulfur in the input stream, and over 2.6 tons of steam are generated for each ton of sulfur yield. Table 12.11 shows a summary of sulfur recovery processes.

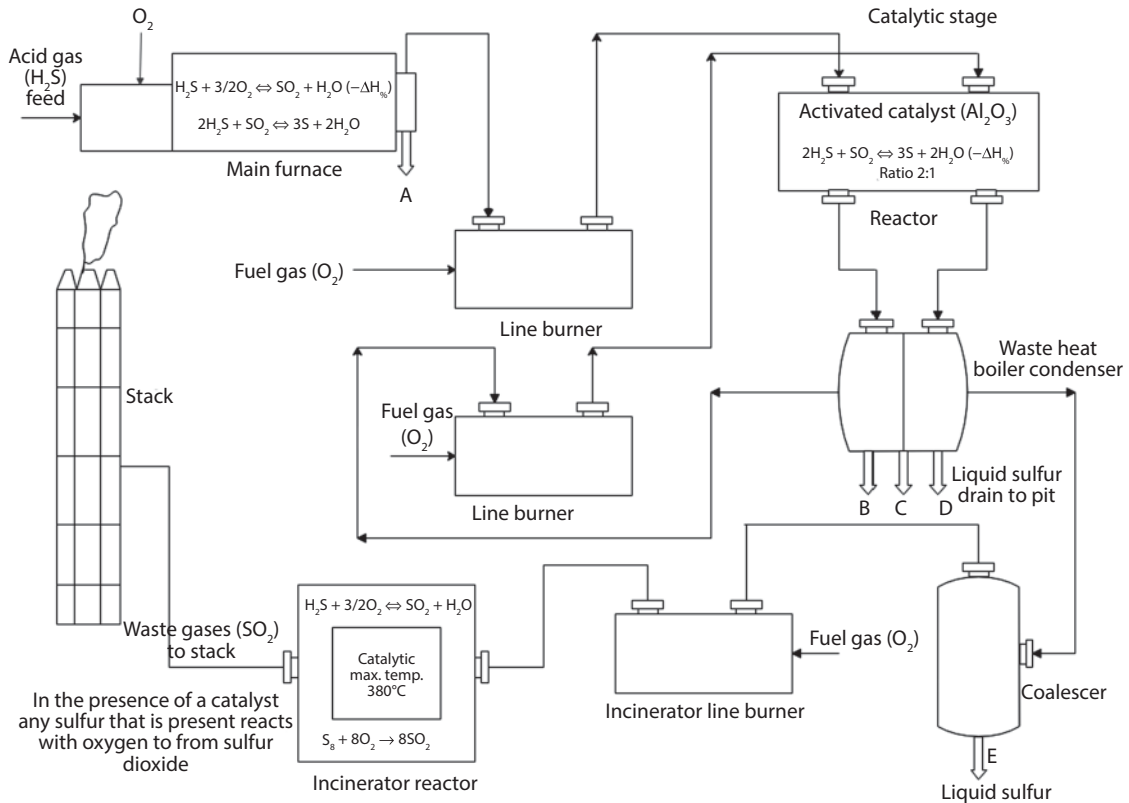
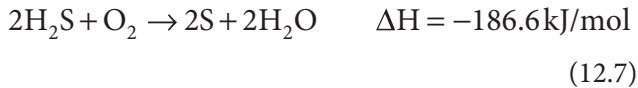
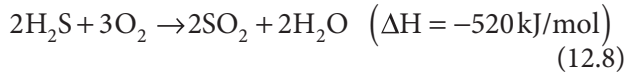


Figure 12.9 Sulfur recovery unit.

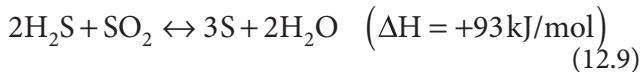
Process Chemistry – High temperature zone



Air to the acid gas is controlled such that one-third of all hydrogen sulfide (H₂S) is converted to SO₂.

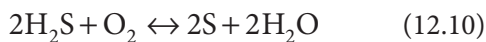


Air to the acid gas is controlled such that one-third of all hydrogen sulfide (H₂S) is converted to SO₂.



- Claus equilibrium reaction, major part of remaining H₂S is also in the main burner.
- H₂S is also, in the downstream catalytic stages.
- Characteristic feature is 2:1 ratio between H₂S and SO₂.

Overall reaction:



Catalytic Incinerator process conditions:

To guarantee the selectivity of the catalyst, which is mainly to convert the typical tail gas components (H₂S, S₈, CS₂, COS), it is necessary that:

- The reactor outlet temperature is at a maximum of 380°C
- The oxygen in the incinerator flue gas is at least 1–2 vol% (O₂-Analyzer flue gas).
- Excess oxygen is maintained at all conditions.
- Claus tail gas is operated at H₂S/SO₂ ratio of 2–4.

Reactions

Fresh catalyst (sulfation)

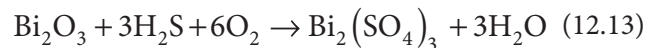
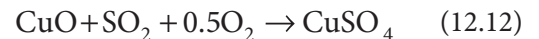
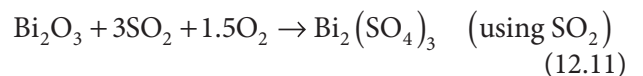


Table 12.11 Sulfur recovery processes.

Sulfur recovery process	Description
<p>Super Claus</p>	<p>The process consists of a thermal stage followed by three catalytic reaction stages with sulfur recovered between the stages by the condenser. The first reactors are filled with standard Claus catalyst, while the final reactor is filled with selective oxidation catalyst.</p> <p>In the thermal stage, the acid gas is burned with a sub-stoichiometric amount of controlled combustion air, such that the tail gas leaving the last Claus reactor contains typically 0.8–1.0 vol. % of H₂S. The selective oxidation catalyst in the final reactor oxidizes the H₂S to sulfur at an efficiency of more than 85%. An overall 99% sulfur recovery can be achieved with a third Claus reactor.</p> <p>Two main principles are applied in operating the SuperClaus process:</p> <ul style="list-style-type: none"> • Operating the Claus plant with excess H₂S to suppress the SO₂ content in the Claus tail gas. • Selective oxidation of the remaining H₂S in the Claus tail gas by means of special catalyst which efficiently converts the remaining H₂S in the presence of water vapor and excess oxygen to elemental sulfur. <p>Over 190 commercial units have been commissioned.</p>
<p>EuroClaus</p>	<p>This is an improvement of SuperClaus process with yields up to 99.7% The EuroClaus process consists of a thermal stage followed by three or four catalytic reaction stages, with sulfur removed between stages by the condensers.</p> <p>The final Claus reactor is filled with a layer of hydrogenation catalyst, followed by a reactor filled with selective oxidation catalyst.</p> <p>In the thermal stage, the acid gas is burned with a sub-stoichiometric amount of controlled combustion air; the tail gas leaving the last Claus reaction typically contains 0.8–1.0 vol. % of H₂S and 100–200 ppmv SO₂. This low SO₂ content is obtained with a hydrogenation catalyst that converts SO₂ to H₂S in the bottom of the last Claus reactor. The selective oxidation catalyst in the final reactor oxidizes the H₂S to sulfur at an efficiency of more than 85%. Total sulfur recovery efficiency up to 99.3% can be obtained with three reactor stages and up to 99.5% can be achieved with four stages.</p>
<p>Shell Claus Off-gas treating (SCOT)</p>	<p>The process is used to remove sulfur components from Claus plant tail gas to further reduce SO₂ emissions.</p> <p>The SCOT process uses catalytic conversion and amine absorption processes with a sulfur recovery levels of up to 99.98%. The process has three sections:</p> <ol style="list-style-type: none"> 1. A reduction reactor, in which all the sulfur compounds present in the Claus tail gas are converted to hydrogen sulfide (H₂S). 2. A cooling/quench section, where the reactor off-gas is cooled and the water is condensed. 3. An absorption section, in which H₂S is selectively absorbed by an amine solution. The loaded solvent is regenerated and the acid gas released is recycled to the inlet of the Claus unit. <p>SCOT technology enables very high levels of sulfur recovery and very low levels of SO₂ emissions to be achieved. Other benefits are:</p> <ul style="list-style-type: none"> • High flexibility – the process can operate over a wide range of sulfur intakes. A turndown ratio of less than 10% of design throughput is achievable. • Low maintenance requirements – The unit requires little operational attention. • Excellent reliability – less than 1% unscheduled downtime has been achieved. • Reduced CO emissions. • Good tolerance to incomplete ammonia destruction in the upstream Claus unit. • No troublesome secondary waste streams. <p>LS-SCOT process: The process uses additive, which improves the regeneration of the solvent with better H₂S removal efficiency.</p> <p>Super SCOT process: The process achieves a H₂S concentration of 10 ppm or a total sulfur content of less than 50 ppmv and is based on a two-stage stripping, optionally with a lower lean solvent temperature.</p>

(Continued)

Table 12.11 Cont.

Sulfur recovery process	Description
<p>Amoco direct oxidation process</p>	<p>When the H₂S concentration is below about 15% in the acid gas, the direct oxidation version of the Modified Claus Process may be considered. Rather than using a burner to combust H₂S to form SO₂, the direct oxidation process catalytically reacts oxygen with H₂S by mixing the air and acid gas upstream of a catalytic reactor. As SO₂ forms, it then reacts with the remaining H₂S via the Claus reaction to form sulfur. The direct oxidation is typically followed by one or more standard Claus reactors to produce and recover additional sulfur. The process is sensitive to catalytic deactivation by contaminants in the acid gas feed (particularly hydrocarbons), so it is not used as much as the other Claus processes.</p>
<p>Oxygen enrichment process</p>	<p>As the environmental regulations continue to tighten, putting growing demand on Claus sulfur recovery processes, this process can become a bottleneck within the refinery. The process is based by enriching the combustion air in a Claus process with oxygen. This increases the capacity significantly as it ensures excellent mixing of hydrogen sulfide and oxygen-enriched air over a wide load range.</p> <p>Benefits of oxygen enrichment:</p> <ul style="list-style-type: none"> • Increased Claus plant capacity at a low revamp capital cost. • Increased productivity without changing the pressure drop. • More effective treatment of feeds containing ammonia. • Greater flexibility in handling feed gas composition variations. • Less effort for tail-gas purification (reduced nitrogen flow) • Ease of installation with minimum disruption to plant operation.
<p>LO-CAT process</p>	<p>This process uses an iron chelate system to remove H₂S directly from the gas stream by an oxidation/reduction reaction where H₂S is directly converted to solid sulfur. The LO-CAT system is designed with separate absorber and oxidizer vessels. Chelated iron catalyst is pumped between the vessels. The absorber removes the H₂S from the sour gas, converting it to elemental sulfur. The oxidizer regenerates the catalyst. The absorber design is determined by the sour gas flow and pressure, as well the H₂S removal efficiency required.</p> <p>Reactions:</p> $H_2S(g) + H_2O \rightarrow H_2S(aqueous) + H_2O$ $H_2S(aqueous) \rightarrow H^+ + HS^-$ $HS^- \rightarrow H^+ + S^-$ $S^{--} + 2Fe^{+++} \rightarrow 2H^+ + S^0 + 2Fe^{++}$ $\frac{1}{2}O_2(gas) + H_2O + 2Fe^{++} \rightarrow 2(OH^-) + 2Fe^{++}$ <p>The overall process reaction is:</p> $H_2S + \frac{1}{2}O_2 \rightarrow H_2S + S_{(Fe)}^0$ <p>Oxygen used in the process comes from air, which is bubbled through the catalyst solution. Because the chelated iron catalyst is not consumed during the reaction, only modest amounts of catalyst are added to the process to replace mechanical losses. A small caustic addition is required to maintain the catalyst solution in the mildly alkaline pH range. Also, additional chelates are added to replace chelates that degrade over time (Figure 12.10)</p>
<p>LO-CAT process II</p>	<p>LO-CAT process II uses the autocirculation principle by combining an absorber and an oxidizer to avoid pumping costs, but uses an improved configuration and catalyst resulting in smaller liquid volumes, lower air rates and pressure subsequently reduced air compressors. The sour gas from the batch reactors is compressed, and then sent through an inlet knockout drum to remove any liquid droplets. The gas is then sparged into the regenerated LO-CAT solution in the absorber sections of the autocirculation vessel. Rotary lobe air blowers supply air that is sparged through the reduced LO-CAT solution in the oxidizer sections of the autocirculation vessel, which circulates the iron catalyst throughout the vessel. Both the H₂S oxidation to sulfur and the regeneration of the iron catalyst occur in one vessel.</p>

(Continued)

Table 12.11 Cont.

Sulfur recovery process	Description
MTE sulfur recovery	MTS sulfur recovery process uses a flowing catalyst in a single reactor/regenerator loop to perform a catalyzed Claus process reaction both above and below the dew point. The unit consists of a furnace, sulfur condenser, reheater, regenerator, water condenser, blower, pipe reactor and reactor vessel.
Improved oxidation process	The process uses partial oxidation catalysis to improve the operation and reliability of the Claus unit. The process uses catalytic combustion instead of conventional Claus burner and thermal reactor. This process uses double catalyst in a short reactor to achieve near equilibrium hydrogen sulfide conversion.
SubDewPoint (SDP) SuperClaus process	<p>The SDP – SuperClaus process adds the selective oxidation stage and the main burner combustion air control of the well-known SuperClaus process to the existing SDP unit. The subdewpoint part consists of a thermal stage followed by two or more catalytic reaction stages with sulfur removed between stages by the condensers. Three main principles are applied in operating the SDP – SuperClaus process:</p> <ol style="list-style-type: none"> 1. Operating the SDP – Claus part with excess H₂S in the SuperClaus process to suppress the SO₂ content in the SDP – Claus tail gas. This principle makes the recovery of the plant less sensitive to the amount of air supplied than in the conventional Claus plants. 2. Operating the last Claus reactor below the sulfur dew point to maximize the sulfur recovery. 3. Selective oxidation of the remaining H₂S in the SDP. Claus tail gas by means of SuperClaus selective oxidation catalyst, which efficiently converts the remaining H₂S in the presence of water vapor and excess oxygen to mainly sulfur.

(Sources: Linde World-wide, www.boconline.co.uk, Merichem Co., www.merichem.com, Jacobs, www.jacobs.com, Shell Global Solutions, www.shell.com, Linde, www.linde-engineering.com).

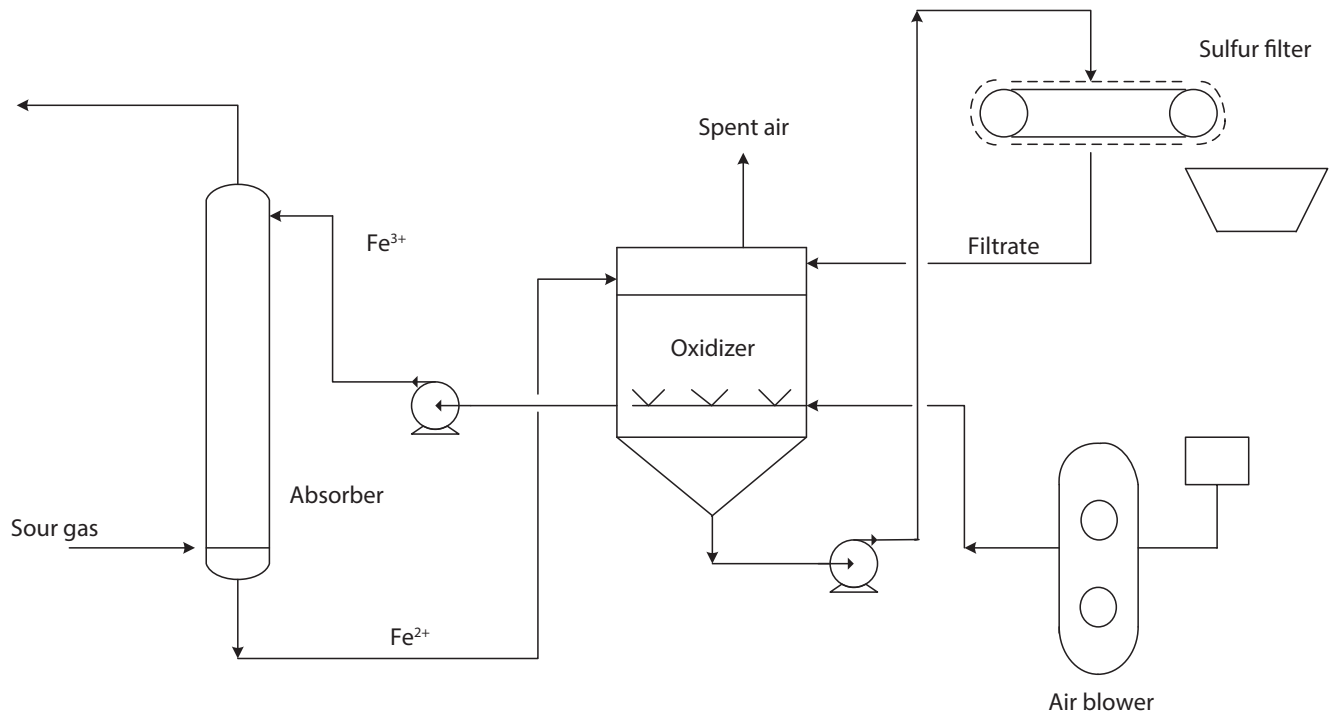
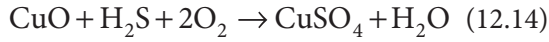
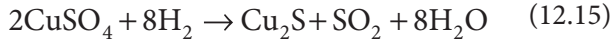


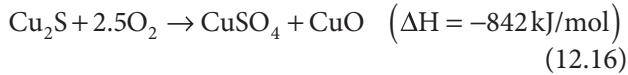
Figure 12.10 H₂S removal process.



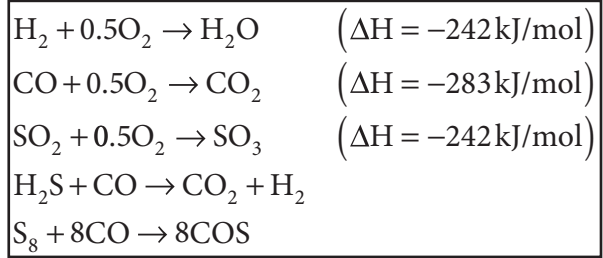
Reducing conditions:



Return to oxidizing conditions:



Temperature > 400°C

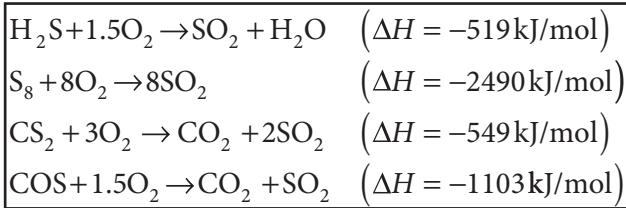


12.5.2 Tail Gas Clean Up

Incinerating the H₂S after sulfur recovery produces SO₂; therefore, further sulfur recovery is carried out for the tail gases. Typical tail gas clean-up (TGCU) process can reduce SO₂ to 0.15 vol % and H₂S to 0.3 vol%. This process contains the Claus catalytic reaction followed by H₂S and SO₂ recovery section (Figure 12.11).

Chemistry – Oxidation of Tail gas components

Target: Temperature, 400°C



12.6 Physical Solvent Gas Processes

The physical solvent types of gas processing are considered when acid gases in the feed are above 50-60 psi, heavy hydrocarbon concentration in the feed gas is low, bulk removal of the acid gas is required and high selective removal of H₂S is desired. Usually physical solvents are economical because regeneration occurs by flashing or stripping which requires little energy. The solvents are regenerated by multi-stage flashing to low pressures; regeneration at low temperatures with an inert stripping gas; heating and stripping of solution with steam/solvent vapors.

Selenol®: licensed by Norton Company uses the dimethylether or polyethylene glycol as a solvent. A Selenol® plant can be designed to provide some selectivity for H₂S, e.g. the plant can be designed to provide pipeline quality gas (0.25 grains H₂S/100 scf) while slipping 85% of the CO₂ present in the original sour gas.

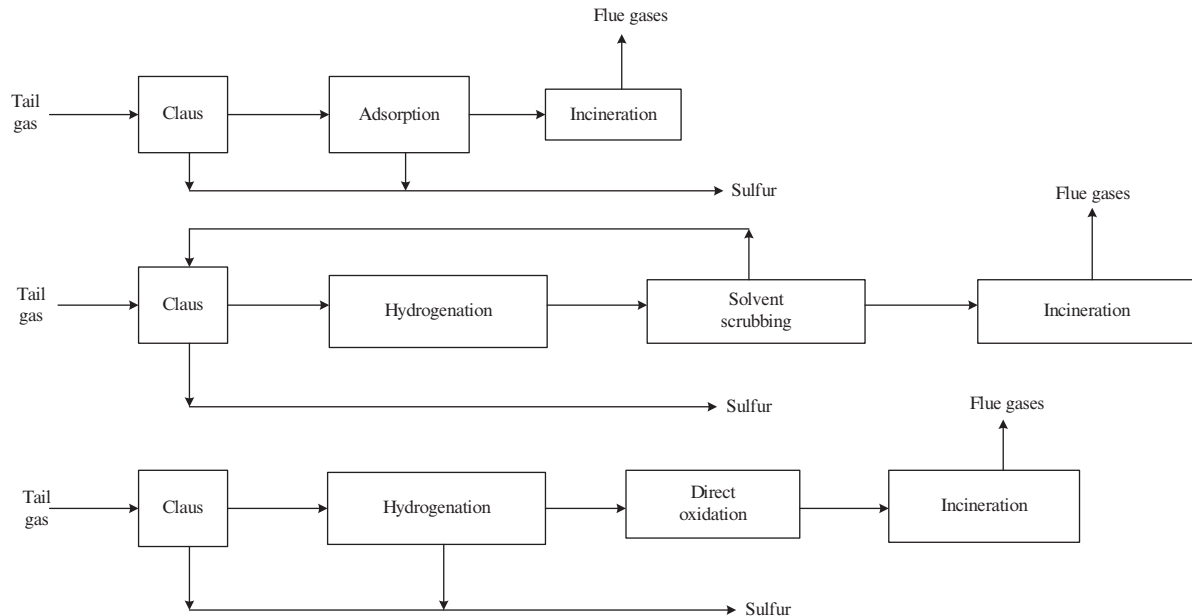


Figure 12.11 Typical Tail gas clean-up scheme [27].

The Fluor Solvent: propylene carbonate is used primarily for removal of CO₂ from high pressure gas streams. The temperature of the lean solution in the absorber is usually well below ambient, and some method of refrigerating the solvent is required. Propylene carbonate is not economical below about 12% acid in the feed [18].

Rectisol: This method developed by Lurgi Co. and Linde A.G. uses methanol as a solvent. Because of the vapor pressure of methanol, the process is normally applied at temperature of -30°F to -100°F. The process has been found suitable for the purification of natural gas for LNG production. It is best suited to situations where there is little ethane and heavier components in the feed.

Purisol: The process has been developed by Lurgi and licensed by the Ralph Parsons Company. The solvent used in this process is N-methyl-2-pyrrolidone (NMP), a high boiling point liquid.

12.6.1 Physical and Chemical Processes

The Sulfinol process developed by Shell Development Company uses both physical and chemical processes for gas treatment. It blends a physical solvent and an amine to obtain the advantages of both. The physical solvent is Sulfolane[®] (tetrahydrothiophene dioxide) and the amine is usually DIPA (diisopropanolamine). The flow scheme is identical to an amine plant.

12.6.2 Advantages and Disadvantages of the Sulfinol[®] Process

Advantages

- The solvent Sulfolane[®], like other solvents, has higher capacity for acid gas at higher acid gas partial pressures. At these higher partial pressures, the Sulfinol[®] process has lower circulation rates (higher solution loading) and better economy than MEA. Sulfinol[®] is preferred over MEA when the H₂S/CO₂ ratio is > 1:1, while at high acid gas partial pressures.
- In solution, the amine DIPA is able to achieve pipeline quality gas (0.25 grains H₂/100 scf).
- COS, CS₂, and mercaptans (RSH) are removed. CO₂ slightly DIPA degrades, but reclamation is easy.
- Low corrosion/carbon steel.
- Low foaming.

- Low vapor losses.

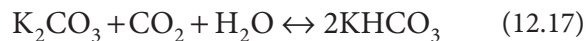
Disadvantages:

- Sulfinol absorbs heavy hydrocarbons, which may provide problems if the acid gas is fed to a sulfur recovery unit.
- The process uses expensive chemicals and the user must pay a process royalty, but losses are low and the licensee receives many engineering services.

12.7 Carbonate Process

The basic process was developed by the U.S. Bureau of Mines and uses an aqueous solution of potassium carbonate (K₂CO₃). The contactor and still both operate at temperatures in the range of 230-240°F. The process is not suitable for gas streams containing only H₂S. Natural gas streams have been economically treated with potassium carbonate. Medium to high acid gas concentrations combined with the high pressures of natural gas transmission lines yield the high partial pressures of acid gases required for the process.

The overall reaction for CO₂ and H₂S with potassium carbonate can be represented by:



For stringent specifications of outlet H₂S and CO₂, special designs or a two-stage process may be required. Maddox [6] states that a two-stage process would typically be used for acid gas feed concentrations of 20-40%. Maddox gives the following rules of thumb for process flow scheme selection:

- Single-stage process will remove CO₂ down to 1.5% in the treated gas.
- A split stream cooling modification will produce 0.8% CO₂.
- Two-stage process or two-stage process with cooler will go below 0.8% CO₂.

He further shows how the major process concerns of corrosion, erosion and column instability must be met in the design and operation of a hot carbonate process, since these items will affect the capital and operating/maintenance costs.

Various processes such as the Benfield, Caracara and Giammarco processes attempt to improve on the basic potassium carbonate process by using activators to increase the rate of CO₂ absorption.

12.8 Solution Batch Process

The Lo-Cat[®] process can be used to sweeten or convert H₂S to sulfur. It catalytically converts H₂S in the gas stream to solid sulfur and will not remove CO₂, COS, CS₂, or mercaptans. Iron is held in dilute solution (high circulation rates) by the common chelating agent EDTA (ethylene diamine tetra acetic acid). The iron oxidizes the H₂S to sulfur. The solution is circulated batch wise to an oxidizer for regeneration.

Chemsweet from C.E. Natco, is another H₂S only process. It uses aqueous dispersion of zinc oxide and zinc acetate to oxidize H₂S and form zinc sulfide. The process can handle H₂S up to 100 grains/100 scf at pressures from 75 -1400 psig. Mercaptans concentrations above 10% of the H₂S concentration can cause problems by forming zinc mercaptides [Zn(SH)RH]. The resulting zinc mercaptide will form sludge and possibly cause foaming problems.

Process Selection

The treatment of gas can affect the design of the entire gas processing facility, including the methods chosen for sulfur recovery and acid gas removal, liquids recovery, liquids fractionation and liquid product treating. Designers should consider the following factors when selecting gas treatment process:

- Specification of the acid gas.
- Hydrocarbon composition of the gas.
- Type and concentration of impurities in the sour gas.
- Temperature and pressure at which the sour gas is available and at which the sweet gas must be delivered.
- Volume of gas to be processed.
- Specification of the residue gas.
- Selectivity required for acid gas removal.
- Air pollution regulation regarding sulfur removal and/or tail gas clean up (TGCU).
- Capital and operating costs.
- Liquid product specifications.
- Royalty cost for process.

Process selection and economics depend on knowing all components present in the gas. Impurities such as COS, CS₂ and mercaptans can present significant impact on the design of both the gas treating and downstream processing facilities. Further, if the gas processing equipment is to be used together with the recovery of liquids, then the requirements for H₂S, CO₂, and mercaptans removal may be affected.

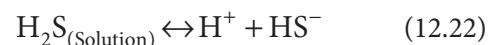
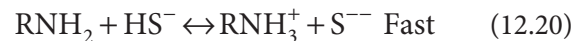
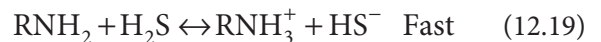
With sulfur recovery, the composition of the acid gas stream feeding the sulfur plant must be considered. CO₂ concentration > 80% in the acid gas may require selectively treating the gas in order to raise the H₂S concentration to the sulfur recovery plant.

High water concentration and hydrocarbons in the feed gas can cause design and operational problems for the sulfur recovery plant, and therefore the effect of these components must be considered when selecting the gas treating process. Further decisions are simplified by considering gas composition and operating conditions. For example, high partial pressures (50 psi) of acid gases increase the likelihood of using physical solvent method. Alternatively, the presence of significant quantities of heavy hydrocarbons in the feed prevents the use of physical solvents. Generally, low partial pressures of acid gases and low outlet specifications would require the use of amines for adequate treatment. Table 12.12 provides a summary for a number of processes.

Chemical Reactions

The overall chemical equilibrium reactions applicable for H₂S and CO₂ reacting with primary and secondary amines are:

For hydrogen sulfide H₂S removal:



For carbon dioxide (CO₂) removal:

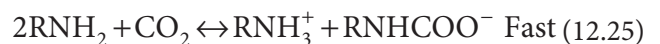
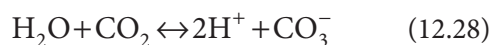
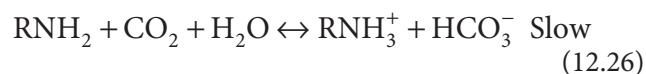


Table 12.12 Process capabilities for gas treating.

	Normally Capable of Meeting ¼ Grains ^{††} H ₂ S	Removes Mercaptans and COS Sulfur	Selective H ₂ S Removal	Solution Degraded (By)
Monoethanolamine	Yes	Partial	No	Yes (COS, CO ₂ , CS ₂)
Diethanolamine	Yes	Partial	No	Some (COS, CO ₂ , CS ₂)
Diglycolamine [®]	Yes	Partial	No	Yes (COS, CO ₂ , CS ₂)
Methyldiethanolamine	Yes	Slight	Yes [‡]	No
Sulfinol [®]	Yes	Yes	Yes [‡]	Some (CO ₂ , CS ₂)
Selenol	Yes	Slight	Yes [‡]	No
Hot Pot-Benfield	Yes [*]	No ⁺	No	No
Fluor Solvent	No ^{**}	No	No	No
Iron Sponge	Yes	Partial	Yes	-
Mol Sieve	Yes	Yes	Yes [‡]	-
Stretford	Yes	No	Yes	CO ₂ at high concentrations
Lo-Cat	Yes	No	Yes	CO ₂ at high concentrations
Chemsweet	Yes	Partial for COS	Yes	No
* Hi-pure version.				
+ Hydrolyzes COS only.				
‡ Some selectivity is exhibited by these processes.				
** Can be met with special design features.				
†† ¼ grain H ₂ S/100 scf ≈ ppm H ₂ S				

(Source: Gas Processor Suppliers Association, *Engineering Data Book*, Vols. 1 and 2, 12th ed., (2004)).



The above reactions proceed to the right at high pressures and/or low temperatures and to the left at high temperatures and/or low pressures. Secondary amines undergo similar reactions as primary amines. Tertiary amines can only react with CO₂ via the acid/base reaction in Equation 12.19. The CO₂ reaction is slowed by the time required to dissolve CO₂ and its conversion to bicarbonate. This may be the reason that tertiary amines exhibit a greater selectivity for H₂S in the presence of CO₂.

Process Description

The process flow diagram for an alkanolamine treating plant is shown in Figure 12.12.

Here, the sour gas enters through an inlet separator for the removal of liquids and/or solids. From the separator, the gas stream enters the bottom of the contactor where it contacts the amine solution flowing down from the top of the column. The acid gas components in the gas react with the amine to form a regenerable salt. As the gas continues to pass up the contactor, more acid gases chemically react with the amine. The sweetened gas leaves the top of the contactor and passes through an outlet separator to trap any solution which may be carried over. Where MEA is the sweetening agent, or the contactor is operating at unusually high temperatures, a water wash may be used to attempt to recover some of the vaporized amine from the gas leaving the contactor. If a water wash is used, it consists of three to four trays at the top of the contactor being used as the absorption section with make-up water to the unit being used as the wash liquid. The sweet gas exiting the contactor is saturated with water so dehydration is required prior to sale of gas. The amine-rich amine solution leaving the contactor flows through a flash tank to remove absorbed hydrocarbons. From there, the solution passes through the rich/lean exchanger where heat is absorbed from the lean solution. The heated rich amine passes

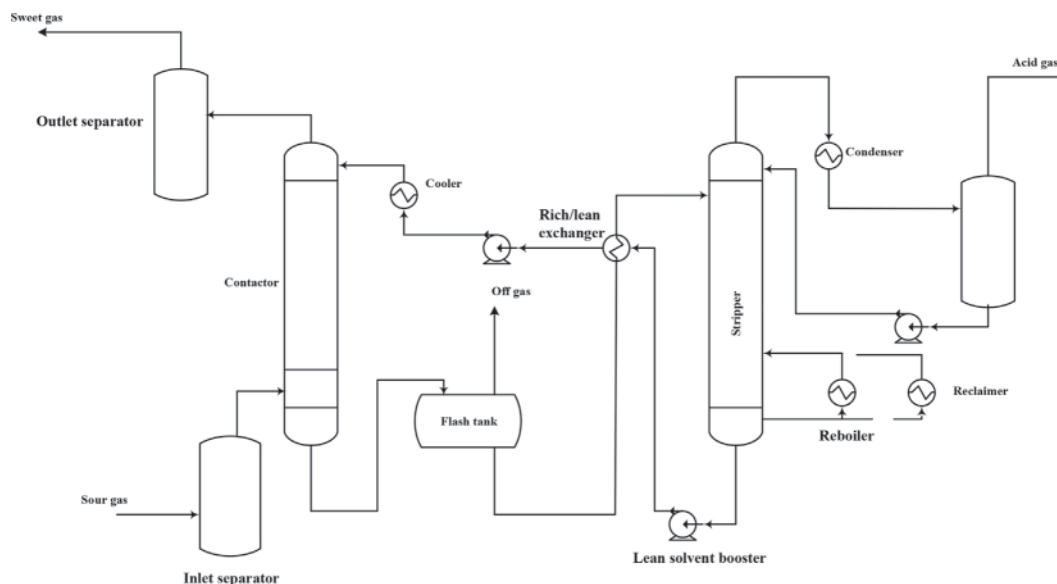


Figure 12.12 Typical gas sweetening by chemical reaction.

to the top section of the stripper. As the solution flows down the column to the reboiler, it is stripped of H_2S and CO_2 . The amine solution then passes through the rich/lean exchanger and a solution cooler to reduce the lean solution temperature to approximately $10^\circ F$ above than the inlet gas temperature in order to stay above the hydrocarbon dew point. The process is repeated as the lean solution is returned to the contactor.

Finally, acid gas stripped from the amine exits from the top of the stripper, where it passes through a condenser to cool the stream and to recover water. The recovered water is usually returned to the stripper as reflux. The acid gas passes through an outlet separator and depending on composition and quantity is vented, sent to sulfur recovery plants or compressed for sale.

12.9 Process Description of Gas Processing using UniSim[®] Simulation

Software

A Case Study

A natural gas stream containing N_2 , CO_2 and $C_1 - nC_4$ is processed in a refrigeration system to remove the heavier hydrocarbons. The lean, dry gas produced will meet a pipeline hydrocarbon dew point specification. The liquids removed from the rich gas are processed in a depropanizer column, yielding a liquid product with specified propane content

UniSim[®] simulator (gas-processing.usc) is used to model a natural gas processing facility that uses propane refrigeration to condense liquids from the feed, and a distillation tower to process the liquids. Figure 12.13 shows a snapshot of the flowsheet; Figure 12.14 shows the phase envelope of the feed having the bubble and the dew points. Figure 12.15 shows the hydrate line intersecting the phase envelope. The critical temperature and pressure of the combined feed are $12.28^\circ C$ and 9976 kPa respectively. The combined feed stream enters an inlet separator, which removes the free liquids. Overhead gas from the SEPARATOR is fed to the gas/gas exchanger, where it is pre-cooled by already refrigerated gas. The cooled gas is then fed to the chiller, where further cooling is accomplished through exchange with evaporating propane (e.g., C3 Duty stream). In the chiller, which is modeled as a COOLER, enough heavier hydrocarbons condense such that the eventual sales gas meets a pipeline dew point specification. The cold stream is then separated in a low-temperature separator (LTS). The dry cold gas is fed to the gas/gas exchanger and then to sales, while the condensed liquids are mixed with free liquids from the inlet separator. These liquids are processed in a depropanizer column to produce a low propane content bottoms product. Figures 12.16 and 12.17 show the phase envelope of the sales gas and with the hydrate line outside the boundary of the phase envelope having critical temperature and pressure as $-33.93^\circ C$ and 8070 kPa. Results of simulation of natural gas processing are shown in gas-processing.usc software, by right-clicking on the

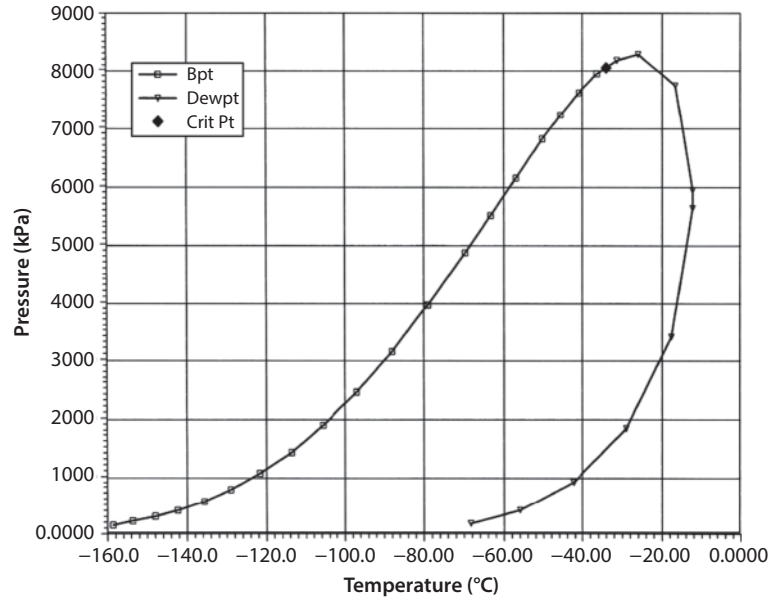


Figure 12.16 Phase envelope of Sales gas.

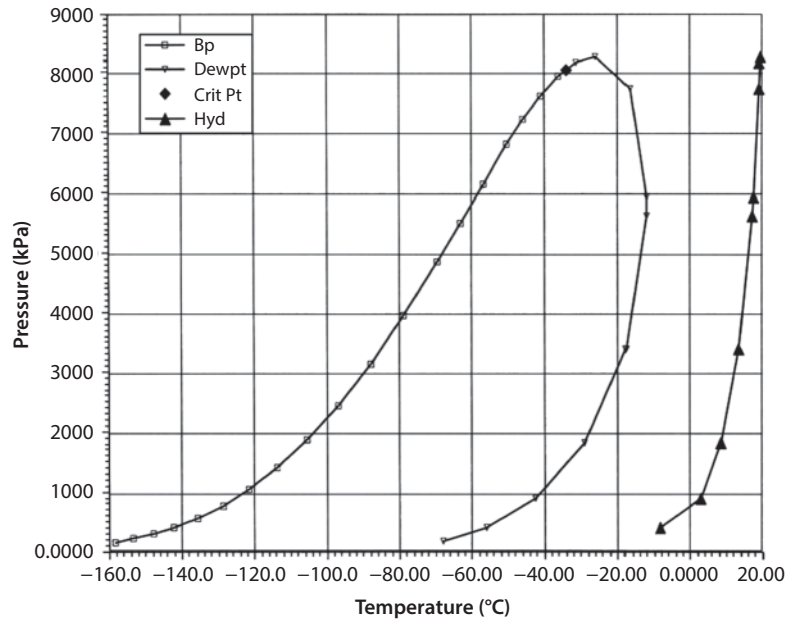


Figure 12.17 Phase envelope of Sales gas.

Depropanizer icon as in Figure 12.18 and clicking on **Print Datasheet**.

Simplified Design Calculations for MEA, DEA and DGA[®]

The following equations are used for making rough estimates of the principal parameters for conventional

MEA, DEA and DGA[®] amine treating facilities when both H₂S and CO₂ are present in the gas. The procedure involves calculating the amine circulation rate and using it as the principal variable in estimating other parameters [7].

For MEA:

$$GPM = 41 \cdot (Qy/x) \tag{12.31}$$

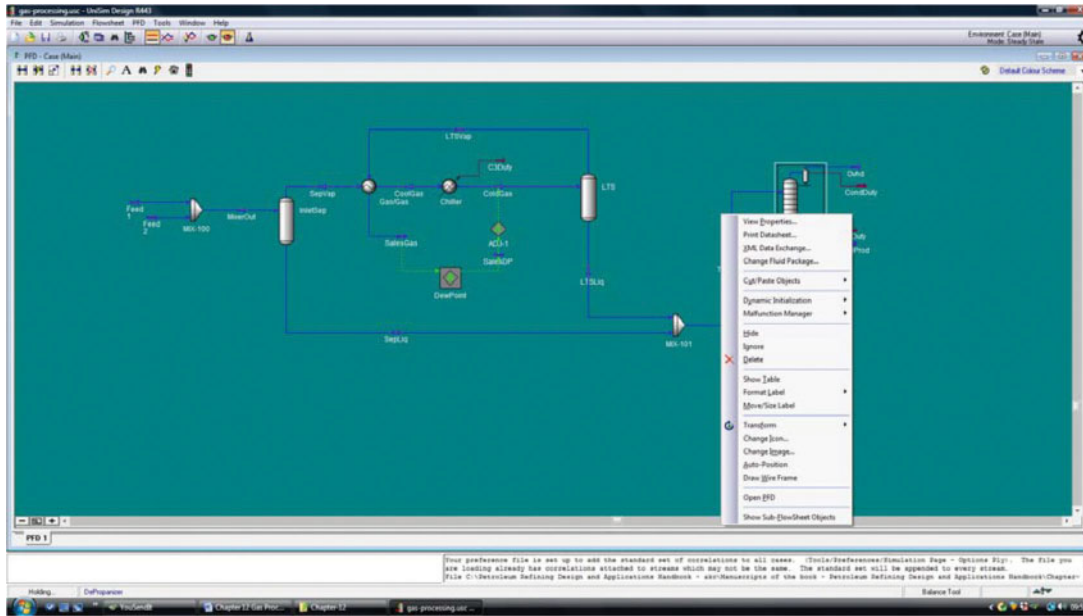


Figure 12.18 A snapshot of the results from Print Datasheet sub-menu. (Courtesy of Honeywell Process Solution, UniSim Design R443, Honeywell (R) and UniSim (R) are registered trademarks of Honeywell International, Inc.)

In S.I. units

$$\text{Flow (m}^3/\text{h)} = 328 \cdot (Q y/x) \quad (12.32)$$

(0.33 mol acid gas pick-up per mole MEA assumed)
For DEA (conventional):

$$\text{GPM} = 45 \cdot (Q y/x) \quad (12.33)$$

In S.I. units

$$\text{Flow (m}^3/\text{h)} = 360 \cdot (Q y/x) \quad (12.34)$$

(0.5 mol acid gas pick-up per mole DEA assumed)
For DEA (high loading):

$$\text{GPM} = 32 \cdot (Q y/x) \quad (12.35)$$

In S.I. units

$$\text{Flow (m}^3/\text{h)} = 256 \cdot (Q y/x) \quad (12.36)$$

(0.7 mol acid gas pick-up per mole DEA assumed)
For DGA®:

$$\text{GPM} = 55.8 \cdot (Q y/x) \quad (12.37)$$

In S.I. units

$$\text{Flow (m}^3/\text{h)} = 446 \cdot (Q y/x) \quad (12.38)$$

(0.39 mol acid gas pick-up per mole DGA® assumed)
(DGA® concentrations are normally 50-60% by weight)

where

Q = Sour gas to be processed, MMscfd, MSm³/day
x = Amine concentration in liquid solution, wt%, mass %

y = Acid gas concentration in sour gas, mole %

After the amine circulation has been estimated, heat and heat exchange requirements can be calculated from the information in Table 12.13; the pump power requirements can be estimated from Table 12.14.

Equations 12.31 to 12.38 provide conservative (high) estimates of required circulation rate. They should not be used if the combined H₂S and CO₂ concentration in the gas is above 5 mole %. They also are limited to a maximum amine concentration of about 30% by weight.

The diameter of an amine plant contactor is:

$$D_c = 44 \left(\frac{Q}{\sqrt{P}} \right)^{0.5} \quad (12.39)$$

In S.I. units

$$D_c = 10750 \left(\frac{Q}{\sqrt{P}} \right)^{0.5} \quad (12.40)$$

where

D_c = Contactor diameter in inches (before rounding up to the nearest 6 inches), or contacting diameter in mm (before rounding up to nearest 100 mm).

Q = MMscfd gas to contactor, MSm³/day gas to contactor.

P = Contactor pressure, psia, kPa(abs).

Table 12.13 Estimated heat exchange requirements.

	Duty		Area	
	Btu/hr	kW	Sq. ft.	m ²
Reboiler (Direct fired)	72,000 · GPM	93 · m ³ /h	11.30 · GPM	4.63 · m ³ /h
Rich-Lean Amine HEX	45,000 · GPM	85 · m ³ /h	11.25 · GPM	4.60 · m ³ /h
Amine cooler (air cooled)	15,000 · GPM	19.3 · m ³ /h	10.20 · GPM	4.18 · m ³ /h
Reflux condenser	30,000 · GPM	38.6 · m ³ /h	5.20 · GPM	2.13 · m ³ /h

(Source: Gas Processor Suppliers Association, Engineering Data Book, Vols. 1 and 2, 12th Ed. (2004)).

Table 12.14 Estimated power requirements.

Main Amine Solution Pumps	GPM · PSIG · 0.00065 = hp	m ³ /h · kPa (ga) · 0.00031 = kW
Amine Booster Pumps	GPM · 0.06 = hp	m ³ /h · 0.20 = kW
Reflux Pumps	GPM · 0.06 = hp	m ³ /h · 0.20 = kW
Aerial Cooler	GPM · 0.36 = hp	m ³ /h · 1.20 = kW

(Source: Gas Processor Suppliers Association, Engineering Data Book, Vols. 1 and 2, 12th ed., (2004)).

The diameter of the regenerator is:

$$D_r = 3.0 \sqrt{GPM} \quad (12.41)$$

In S.I. units.

$$D_r = 160 \sqrt{m^3/h} \quad (12.42)$$

where

D_r = Regenerator bottom diameter in inches, mm.

The diameter of the section of the still above the feed point can be estimated of 0.67 times the bottom diameter.

Example 12-2

40.0 MMscfd of gas available to 900 psig and containing 0.5% H₂S and 2.5% CO₂ is to be sweetened using 25% by weight DEA solution. If a conventional DEA system is to be used, what amine circulation rate is required, and what will be the principal parameters for the DEA treatment system?

Solution

Using Equation 12.33, the required solution circulation is:

$$GPM = 45 \cdot (Qy/x) = 45 (40.0 \times 3.0/25) = 216 \text{ gallons of 25\% DEA solution per minute.}$$

Heat exchange requirements are shown in Table 12.13.

Reboiler

$$H = 72,000 \times 216 = 15.6 \times 10^6 \text{ Btu/hr}$$

$$A = 11.30 \times 216 = 2441 \text{ ft}^2$$

Rich-Lean amine exchanger

$$H = 45,000 \times 216 = 9.72 \times 10^6 \text{ Btu/hr}$$

$$A = 11.25 \times 216 = 2430 \text{ ft}^2$$

Amine cooler

$$H = 15,000 \times 216 = 3.24 \times 10^6 \text{ Btu/hr}$$

$$A = 10.2 \times 216 = 2203 \text{ ft}^2$$

Reflux condenser

$$H = 30,000 \times 216 = 6.48 \times 10^6 \text{ Btu/hr}$$

$$A = 5.20 \times 216 = 1123 \text{ ft}^2$$

Power requirements from Table 12.14

$$\text{Main amine pumps, hp} = 216 \times 900 \times 0.00065 = 126.4$$

$$\text{Amine booster pumps, hp} = 216 \times 0.06 = 13$$

$$\text{Reflux pumps, hp} = 216 \times 0.06 = 13$$

$$\text{Aerial cooler, hp} = 216 \times 0.36 = 78$$

Contactor diameter from Equation 12.39

$$D_c = 44 \left(\frac{Q}{\sqrt{P}} \right)^{0.5} = 44 \left(\frac{40}{\sqrt{914.7}} \right)^{0.5} = 50.6 \text{ inches or 48 inches rounded down.}$$

Regenerator diameter below feed point:

$$D_r = 3.0 \sqrt{GPM}$$

= $3.0 \times \sqrt{216} = 44.1$ inches or 48 inches (bottom)
rounded up to nearest 6 inches.

Regenerator diameter above feed point:

$$D_{ra} = 0.67 \times 48 = 32.2$$
 inches or 36 inches (top)
rounded up to nearest 6 inches.

12.10 Gas Dryer (Dehydration) Design

Natural gas and associated condensate are often produced from the reservoir saturated with water. Additionally, the gas and condensate often contain CO_2 and H_2S which require removal. Liquid water and sometimes water vapor are removed from natural gas to prevent corrosion and formation of hydrate in transmission lines and to attain a water dew point requirement of the sales of gas. Also, many sweetening agents employ aqueous solution for treating the gas. Dehydration is the process used to remove water from natural gas and natural gas liquids (NGLs) and it is necessary to:

- Prevent the formation of hydrates and condensation of free water.
- Prevent corrosion.
- Meet a water content specification.

Dehydrating the natural gas after the sweetening process involves:

- Dehydrating by refrigeration.
- Dehydration with CaCl_2 .
- Dehydration by distillation.
- Dehydration by membrane permeation.
- Dehydration by gas stripping.
- Absorption by liquid desiccants.
- Adsorption by solid desiccants.

Adsorption is a process that involves the transfer of a material from one phase to a surface where it is bound by intermolecular forces, and involves the transfer from a gas or liquid to a solid surface. It could also involve the transfer from a gas to a liquid surface. The adsorbate is the material being concentrated on the surface and the material that it accumulates is known as the adsorbent.

The oil and chemical industries use the adsorption process in the cleanup and in purification of wastewater streams, dehydration of gases and in gas purification

to remove sulfur dioxide from a stack gas. In addition, adsorption is also employed to fractionate fluids that are difficult to separate by other methods. Porous desiccants (adsorbents) with a large internal surface area are used for industrial applications as the amount of adsorbate collected per unit area is very small.

The most common commercially used desiccants are alumina, silica gel, and molecular sieves. The last of which possess the highest water capacity, will give the lowest water dew points, and can be applied to sweeten dry gases and liquids. Figure 12.19 shows how desiccants can be used in dehydrators containing two or more towers and Table 12.15 presents the important properties of commercial solid desiccants. Figure 12.20 shows a typical geometry of solid desiccant dryer. One of the towers is in operation, using steam to adsorb water from gas, while the other tower is regenerated and cooled. The regenerated gas is heated to a range of 450°F and 600°F , depending on the type of solid desiccant and the nature of service [8].

The use of solid desiccant is limited to applications with very low water dew point requirements, where simultaneous control of water and hydrocarbon dew points are required, and in very sour gases. In cryogenic plants, solid-desiccant dehydration is much preferred over methanol injection to prevent hydrate and ice formation.

The basic design procedures for dehydrating a saturated natural gas at a specified dew point are:

1. Determine the process conditions and the dryer process flow diagrams.
2. Select the drying cycle and calculate the water load.
3. Select the desiccant type and compute the capacity and volume required.
4. Size the dryer and check for the pressure drop.
5. Calculate the desiccant reactivation heating and cooling requirements.

Here, design procedures are presented for sizing a solid desiccant dryer in removing moisture from gas streams. The process involves the following calculations.

- The water pickup
- Desiccant volume
- Desiccant bed.
- Gas velocity through the bed.
- Vessel weight
- Dryer regeneration requirements.

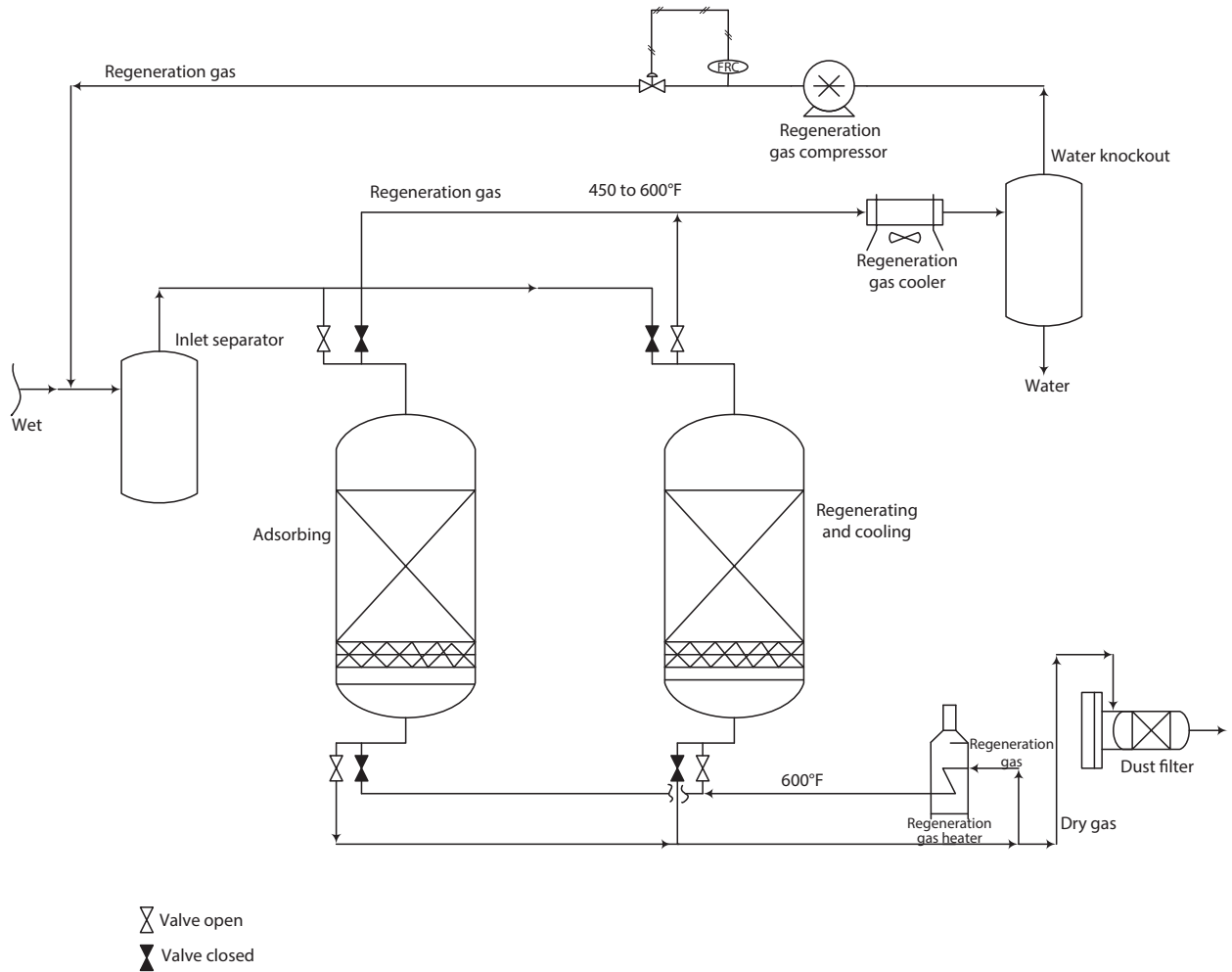


Figure 12.19 Solid desiccant dehydrator twin tower system.

Table 12.15 Typical desiccant properties.

Desiccant	Shape	Bulk density lb/ft ³	Particle size	Heat capacity, Btu/(lb°F)	Approx. minimum moisture content of effluent gas
Alumina Alcoa F200	Beads	48	7 x 14 Tyler mesh 1/8"/ 3/16"/1/4"	0.24	-90 F dew point
Activated Alumina UOP A-201	Beads	46	3 – 6 mesh or 5 – 8 mesh	0.22	5–10 ppmv
Mol Sieve Grace – Davison 4A	Beads	42–45	4 – 8mesh or 8 – 12 mesh	0.23	0.1 ppm (-150 °F)
Molecular Sieve UOP 4A – DG	Extrudate	40–44	1/8" or 1/16"	0.24	0.1 ppm
Mole Sieve Zeochem 4A	Beads	45– 46	4 – 8 mesh or 8 – 12 mesh	0.24	0.1 ppm
Silica Gel Sorbead® - R	Beads	49	5 x 8 mesh	0.25	-60 °F dew point
Silica Gel Sorbead® - H	Beads	45	5 x 8 mesh	0.25	-60°F dew point
Silica Gel Sorbead® - WS	Beads	45	5 x 8 mesh	0.25	-60°F dew point

(Source: Engineering Data Book: Gas Processor Suppliers Association, 12th Ed. Tulsa, Oklahoma, 2004)

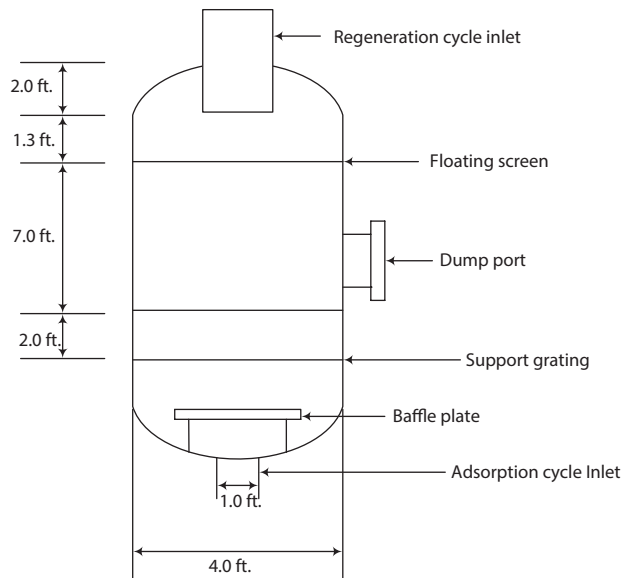


Figure 12.20 Geometry of a typical solid desiccant dryer.

The design is based upon the following assumptions [8]

1. The temperature difference between the heater outlet temperature and the peak vessel outlet temperature is 50°F.
2. The average bed temperature is based on 75% of the bed at heater outlet temperature and 25% at the peak vessel outlet temperature Equation 12.52.
3. Specific heats: steel, 0.12 Btu/lb°F, and desiccant 0.25 Btu/lb °F.
4. Heat of water desorption 1400 Btu/lb H₂O adsorbed.
5. Flat heads used on vessel ends; steel density is 480 lb/ft³.
6. Total vessel weight increased by 10% for supports.
7. Heat losses to the dryer heating period calculated at 5%.

12.10.1 The Equations

The equations used for calculating these requirements are:

The total water adsorbed, lb

$$\begin{aligned}
 H_2O \text{ load} &= \frac{(Flow)(Cycle)(H_2O \text{ Cont})}{24} \quad (12.43) \\
 &= \frac{\left(\frac{MM \text{ std ft}^3}{\text{day}}\right)(h)\left(\frac{lb}{MM \text{ std ft}^3}\right)}{(h/\text{day})}
 \end{aligned}$$

Desiccant volume

$$V_{DES} = \frac{(H_2O \text{ load})(100)}{(pickup)(\rho_D)} \quad (12.44)$$

The calculated area based on desiccant volume

$$A_{DES} = \frac{V_{DES}}{L} \quad (12.45)$$

The bed diameter

$$D_{BED} = \left(\frac{4A_{DES}}{\pi}\right)^{0.5} \quad (12.46)$$

Actual desiccant bed area

$$A = \frac{\pi D_{BED}^2}{4} \quad (12.47)$$

The actual gas flow rate at flowing conditions, ft³/min

$$\begin{aligned}
 Q &= (Flow) \left(\frac{14.7}{P+14.7}\right) \left(\frac{T}{520}\right) \left(\frac{1}{1440}\right) (Z) \\
 &= (Flow) \left(\frac{T}{P+14.7}\right) (Z) (19.6314) \quad (12.48)
 \end{aligned}$$

Superficial gas velocity, ft/min

$$V_{GAS} = \frac{Q}{A} \quad (12.49)$$

Superficial gas velocities for adequate contact time should range between 30 and 60 ft/min.

Dryer shell thickness, inch.

$$t = \frac{PR}{SE - 0.6P} \quad (12.50)$$

Vessel weight

$$W_{VES} = 480 \pi D \left(\frac{t}{12}\right) (L+h+R) (1.10) \quad (12.51)$$

Add an extra 2 ft (h = 2) of straight side (i.e., for 6 in. of 3/8 in. inert balls above and below the desiccant bed and 1 ft for an inlet-gas distributor).

Temperature of desiccant bed, °F

$$T_{BED} = 0.75(HT) + 0.25(HT - 50) \quad (12.52)$$

The total heat required to regenerate the dryer (ideal), Btu

$$HTOT = \left\{ (W_{VES})(0.12)(T_{BED} - T) + (W_D)(0.25)(T_{BED} - T) + (H_2O_{load})(1400) \right\} \quad (12.53)$$

where

$$W_D = (\rho_D)(V_{DES}) \quad (12.54)$$

Loss factor for non-steady state heating, F

$$F = \ln \left(\frac{HT - T}{50} \right) \quad (12.55)$$

Heat added to regeneration gas to regenerate the desiccant bed

$$H_{REG} = H_{TOT} \cdot F \quad (12.56)$$

The total regeneration gas requirement, lb

$$H_{GAS} = \frac{H_{REG}}{H_1 - H_2} \quad (12.57)$$

Standard cubic feet of regeneration gas

$$SCF = \frac{H_{GAS}(380)}{MW} \quad (12.58)$$

12.10.2 Pressure Drop (ΔP)

The pressure drop is estimated from the desiccant manufacturer's data and correlations. In addition, ΔP can be calculated by Wunder's [9] graphical correlation of gas superficial velocity against ΔP in ft water per ft. bed. Wunder used a factor of 1.6 for a fouled bed. ΔP for a new desiccant bed is initially low. After a short time in service, ΔP rises because of bed settling and then slowly increases over the active life of the desiccant because of more settling and some attrition. Figure 12.21 shows ΔP for an 8-inch silica gel desiccant. These data are based on using air. For other gases, the given values should be multiplied by $(MW_{gas}/MW_{air})^{0.9}$. The pressure drop for a clean bed is given by:

$$\Delta P = \left(\frac{ft. H_2O}{ft. bed} \right) \left(\frac{0.4335 psi}{ft. H_2O} \right) \left(\frac{MW_{gas}}{MW_{air}} \right)^{0.9} \quad (12.59)$$

12.10.3 Fouled Bed

$$\Delta P = (clean\ bed\ \Delta P)(1.6) \quad (12.60)$$

Desiccant attrition due to high gas velocities is controlled by proper bed design. The superficial gas velocity is used to estimate Alcoa's momentum down flow velocities [9]. However, desiccant attrition should not be a problem when the momentum number is equal to or less than 30,000. Although, this number is based on granular alumina, it can be used for silica gel, which has crushing characteristics similar to alumina. The momentum is expressed as:

$$Momentum = (V_{GAS})(MW) \left(\frac{P + 14.7}{14.7} \right) \leq 30,000 \quad (12.61)$$

where

- V_{GAS} = superficial gas velocity, ft./min.
- MW = molecular weight of gas.
- P = system pressure in psig.

Desiccant Reactivation

The desiccant bed is reactivated at as high a temperature as permissible to regain optimum capacity and minimum dew points. In natural gas drying service, the normal reactivation temperature for silica gel is

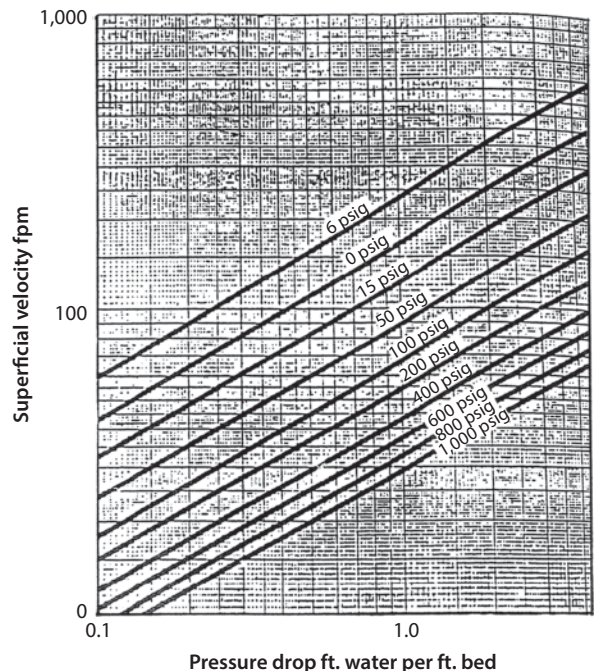


Figure 12.21 Pressure drop for an 8 mesh silica gel desiccant (Source: Wunder, J. W., "How to Design a Natural Gas Drier", *Oil & Gas Journ.*, Aug. 6, pp 137-148, 1962).

between 350°F and 400°F. Because the feed gas contains high pentanes-plus materials, Wunder [9] suggested that reactivation can be carried out at 450°F to desorb the heavy hydrocarbons.

At a temperature above 450°F, the attrition rate for silica gel is high. However, occasionally at 600°F, reactivation will restore some desiccant's initial activity thus extending the life of the silica gel. Therefore, the reactivation procedure is designed to periodically heat the desiccant to 600°F [9].

Example 12-3

Size the dryer using silica gel using the data in Table 12.16

Solution

Computer program PROGDRY has been developed to calculate the total regeneration flow, the heat requirement for dryer regeneration, the momentum and superficial gas velocity. Table 12.17 illustrates the input data and the computer output. The total regeneration flow is 44649.0 lb and the momentum is 30,584. The heat requirement for dryer regeneration is 5.6 x 10⁸ Btu. The calculated superficial gas velocity is 34.9 ft./min.

From Figure 12.21

The superficial gas velocity = 35 ft./min.

Desiccant bed length = 15.0 ft.

System pressure = 700 psig.

The clean bed ΔP using Equation 12.59 is:

$$\Delta P = 0.87 \frac{ft. H_2O}{ft. bed} \left(\frac{0.4335 psi}{ft. H_2O} \right) (15.0 ft. bed) \left(\frac{18}{29} \right)^{0.9}$$

$$= 3.68 psi$$

Table 12.16 Dry parameters.

Flow = 65 MM std ft ³ /day	Desiccant H ₂ O cap = 8%
P = 700 psig	Desiccant density = 50 lb/ft ³
T = 80°F	Desiccant bed length = 15 ft
Z = 0.9228	Heater outlet = 500°F
H ₂ O Cont = 47 lb/MM std ft ³	MW = 18
S = 15,500 lb/in ²	H ₁ = 490 But/lb
E = 1.0	H ₂ = 225 Btu/lb
Cycle = 12h	h = 2.0 ft.

Table 12.17 Input data and computer output for gas dryer design.

Data name: DataDRY.Dat		
65.0	700.0	80.0
0.9928	12.0	47.0
15500.0	1.0	8.0
50.0	15.0	500.0
18.0	490.0	225.0

Gas Dryer Design	
Gas flow rate, 10 ⁶ std. ft ³ /day	65.000
Dryer operating pressure, psig	700.000
Gas flowing temperature, °F	80.0
Gas compressibility factor	0.9228
Drying cycle, hr.	12.0
Water content of gas, lb/10 ⁶ std. ft ³	47.0
Allowable stress, psi	15500.0
Joint efficiency	1.0
Useful design capacity of desiccant (%)	8.0
Desiccant density, lb/ft ³	50.0
Heater outlet temperature, °F	500.0
Molecular weight of regeneration gas	18.0
Enthalpy of gas before regeneration heater, Btu/lb	490.0
Enthalpy of gas after regeneration, heater, Btu/lb	225.0
Total water adsorbed, lb/h	1527.500
Desiccant volume, ft ³	381.8750
Calculated cross-sectional area, ft ²	25.4583
Bed diameter, ft	5.6934
Bed radius, ft	34.1603
Bed length, ft	15.00
Actual gas flow rate, ft ³ /min	889.697
Superficial gas velocity, ft/min	34.947
Dryer shell thickness, in.	1.5857
Vessel weight, lb	24767
Desiccant weight, lb	19094
Temperature of desiccant bed, °F	487.500
Total heat required to regenerate dryer, Btu	0.555954E+07
Loss factor	2.1282
Heat added to regeneration gas, Btu.	0.118320E+08
Total regeneration gas requirement, lb	0.446490E+05
Standard cubic feet of regeneration gas, std ft ³	0.942590E+06
Momentum	0.305838E+05

Hydrocarbon Absorption and Stripping (With Contributions by Dr. P. A. Bryant [10])

Many operations in refineries/petrochemical plants require the absorption of components from gas streams into “lean” oils or solvents. The resultant “rich” oil is then stripped or denuded of the absorbed materials. The greatest use of this operation utilizes hydrocarbon materials, but the basic principles are applicable to other systems provided adequate equilibrium data are available.

Several methods [11–17] for handling this design have been offered and each has introduced a concept to improve some feature. An approximation method in combining Kremser-Brown [14, 16] and a more complete method of Edmister [12] will be summarized. Figure 12.22 summarizes the system and terminology.

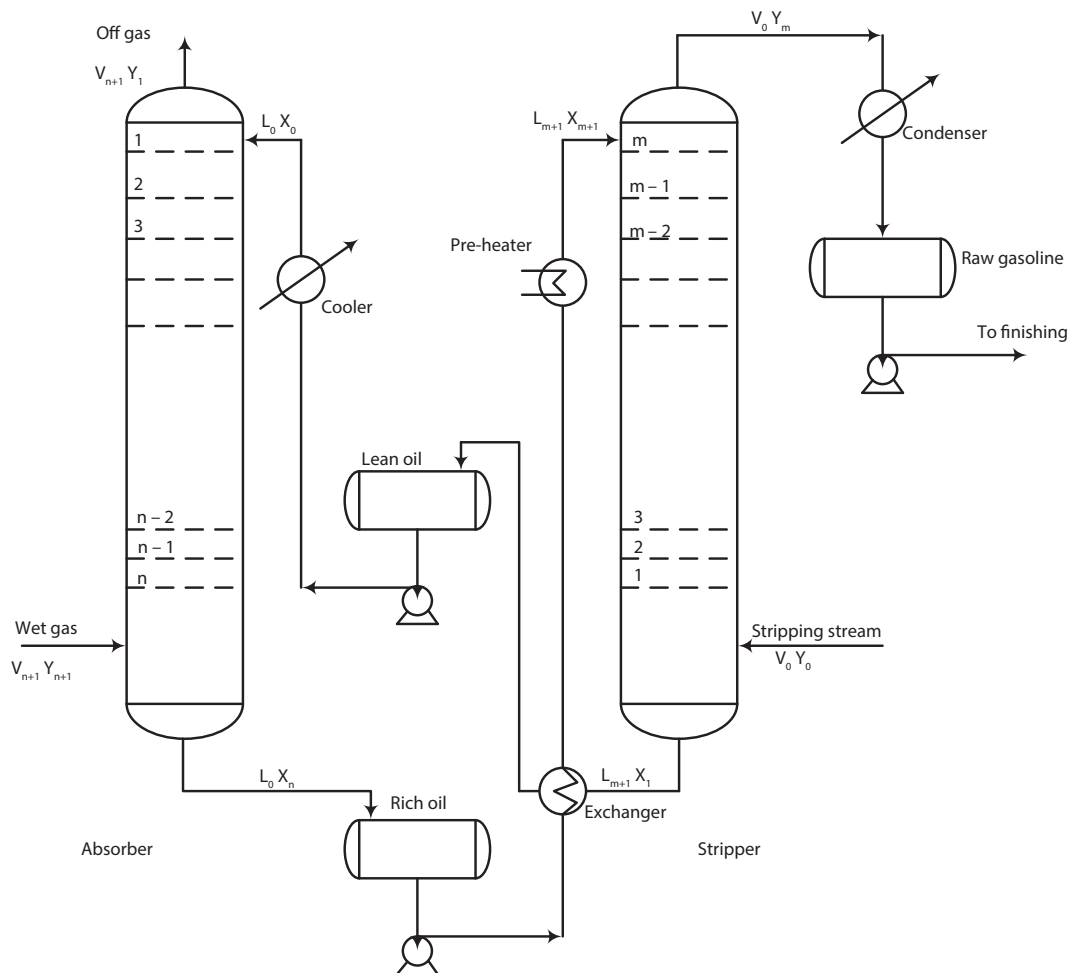


Figure 12.22 Flow diagram of absorption-stripping for hydrocarbon recovery from gaseous mixture. (Used by permission, Edmister, W. C., *Petroleum Engr.*, Sept. (1947) to January (1948).

12.11 Kremser-Brown-Sherwood Method-No Heat of Absorption [14]

This method gives reasonably good results for systems involving relatively lean gas and small quantities absorbant. For rich gases the error can be considerable (more than 50% for some components). It has given generally good results on natural gas and related systems.

12.11.1 Absorption: Determine Component Absorption in Fixed Tray Tower (Adapted in part from Ref. 12)

1. Calculate the total mols. of gas inlet to the absorber, identifying the quantities of individual components.

2. Assuming the tower pressure as set and that an average of top and bottom temperatures can be selected (these may become variables for study), read equilibrium K_i values from charts for each component in gas.
3. Assume or fix a lean oil rate.
4. Calculate

$$\frac{L_o}{V_{N+1}} = \frac{\text{Mols/hr lean oil in}}{\text{Mols/hr rich gas in}} \quad (12.62)$$

Assume this is a constant value for tower design.

5. Calculate absorption factor, $A_i = L_o/(V_{N+1} K_i)$, using values of (2) and (4) above for each component.
6. Calculate fraction absorbed for each component, assuming a fixed overall tray efficiency for an assumed number of actual trays (or an existing column with trays).
 - a. Theoretical number of trays, $N = (\text{tray efficiency, } E_o) (\text{number of actual trays})$
 - b. Fraction absorbed

$$E_{ai} = \frac{Y_{N+1} - Y_i}{Y_{N+1} - Y_o^*} = \frac{A_i^{N+1} - A_i}{A_i^{N+1} - 1} \quad (12.63)$$

where Y_o^* is often considered zero or very small. Solve using A_i values.

7. Mols each component absorbed/hr.

$$= (V_o Y_{(n+1)i}) (E_{ai})$$

8. Mols each component absorbed/(mol inlet lean oil)

$$(\text{hr}) = X_{iR}$$

9. Mols of each component in gas out top of absorber:

$$= (\text{mols component in inlet gas}) - (\text{mols component absorbed})$$

10. Mols of component in gas out top of absorber/mol of inlet rich gas:

$$E_{ai} = \frac{Y_{N+1} - Y_i}{Y_{N+1} - Y_o^*}$$

Solve for Y_i

11. Correct values from first calculation, Steps 1 through 10, using the ΣX_{iR} values of Step 8, as follows.
12. Calculate A_i :

$$A_i = \frac{L_o}{V_{N+1} K_i} \left(1 + \Sigma X_{iR} \right) \quad (12.64)$$

13. Calculate absorption efficiency, E_{ai} . Using new A_i value

$$E_{ai} = \frac{A_i^{N+1} - A_i}{A_i^{N+1} - 1}, \text{ read Figure 12.23}$$

14. Calculate mols absorbed/hr:

$$= (E_{ai}) (\text{mols component in inlet rich gas})$$

15. Mols of each component in gas out top of absorber/hr = (mols component in) - (mols component absorbed)
16. Mols of component in outlet gas/mol inlet rich gas. Solve for Y_{li}

$$E_{ai} = \frac{Y_{N+1} - Y_{li}}{Y_{N+1} - Y_o^*}$$

If the X_i in equilibrium with Y_i is desired:

$$X_i = \frac{Y_i \left(1 + \Sigma X_{iR} \right)}{K \Sigma Y_i} \quad (12.65)$$

17. Improved values can be obtained by recalculation from Step 11 if there is too great a difference between the "Σ mols absorbed" from trial no. 1 and trial no. 2.

First trial

Component	Inlet	Mols/hr	K_i	$A = \frac{L}{VK_i}$
	$Y_{(N+1)i}$	In		
•	•	•	•	•
•	•	•	•	•
•	•	•	•	•
	1.00	$\Sigma \bullet$		

Component	Fraction Absorbed	Mols Absorbed	X_{iR}	Mol/hr Off Gas	$Y_{li(out)}$
	E_{ai}				
•	•	•	•	•	•
•	•	•	•	•	•
•	•	•	•	•	•
	$\Sigma \bullet$	$\Sigma \bullet$	$\Sigma \bullet$	$\Sigma \bullet$	

For second trial, see Step 11.

18. A graphical stepwise procedure is offered by Sherwood [15] and also summarized by Reference 12. Y and X are plotted and handled stepwise as in distillation. The equilibrium line equation is for any single component:

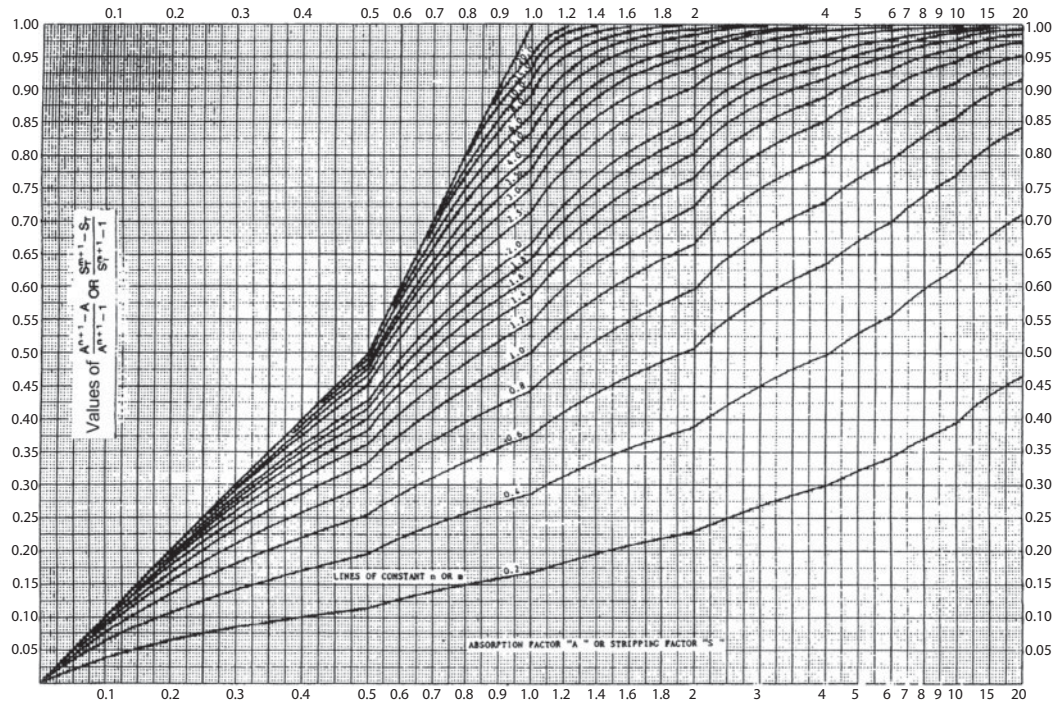


Figure 12.23 Absorption and stripping factors, E_a or E_s vs. effective values A_e or S_e (efficiency functions). Used by permission, Gas Processing Suppliers Association, *Engineering Data Book*, vol. 12, 12th ed., Tulsa, Oklahoma (2004).

$$\frac{Y_i}{X_i} = K_i \left(\frac{\sum Y_i}{1 + \sum X_i} \right) \quad (12.66)$$

For a complete denuded inlet solvent at the top $\Sigma X = 0$, using K at top column conditions. The slope of the operating line = L_o/V_{N+1} = mols lean oil entering/mols wet gas entering.

12.11.2 Absorption: Determine the Number of Trays for Specified Product Absorption

1. For fixed tower temperature, pressure, gas feed rate, specified or assumed operating (L_o/V_{N+1}) times minimum value, specified component recovery out of inlet gas.
2. Calculate:
 - a. Mols component in inlet gas/hr
 - b. Mols in outlet gas

$$= \frac{100 - (\% \text{recovery})(\text{total mols in})}{100}$$

- c. Mols component absorbed = inlet – outlet
3. Calculate: E_{ai} for specified component (specified in 1.)

$$E_{ai} = \frac{\text{Mols component in} - \text{Mols component out}}{\text{Mols component in}}$$

= specified fraction recovery

4. Minimum (L/V) for specified component:

$$\left(L_o / V_{N+1} \right)_{\min} = KE_a \left[\frac{\sum Y}{1 + \sum X} \right]$$

Assuming equilibrium at bottom, $\Sigma Y = 1$. Ignoring ΣX gives slightly conservative value,

$$\left(\frac{L_o}{V_{N+1}} \right)_{\min} = K_i E_{ai}$$

5. Operating $(L_o/V_{N+1})_o$
= (specified unit) $(L_o/V_{N+1})_{\min}$
6. Operating

$$A_{io} = \left(\frac{L_o}{V_{N+1}} \right)_o \left(\frac{1}{K_i} \right) \quad (12.67)$$

7. Theoretical number of plates at operating (L_o/V_{N+1}): solve for N.

$$E_{ai} = \frac{A_{io}^{N+1} - A_{io}}{A_{io}^{N+1} - 1} \quad (12.68)$$

$$(N + 1) \log(A_{io}) = \log \left[\frac{(A_{io} - E_{ai})}{(1 - E_{ai})} \right]$$

8. Actual number of trays at operating (L_o/V_{N+1}):

$$N_o = N/E_o$$

E_o values may be calculated from Figure 12.24 or assumed at 20 to 50% as an estimating value for hydrocarbon oil and vapors, pressures atmospheric to 800 psig, and temperatures of 40°F to 130°F (see Table 12.18).

9. Lean oil rate:

$$L_o = (A_i)(K_i)(V_{N+1})_o, \text{ mols / hr} \quad (12.69)$$

10. For other components: E_{ai} is estimated by

$$E_{ai} = (E_{ai}) \left(\frac{K_1}{K_2} \right), \text{ with} \quad (12.70)$$

a limiting value of unity.

12.11.3 Stripping: Determine the Number of Theoretical Trays and Stripping Steam or Gas Rate for a Component Recovery [12]

The rich gas from the absorption operation is usually stripped of the desirable components and recycled back

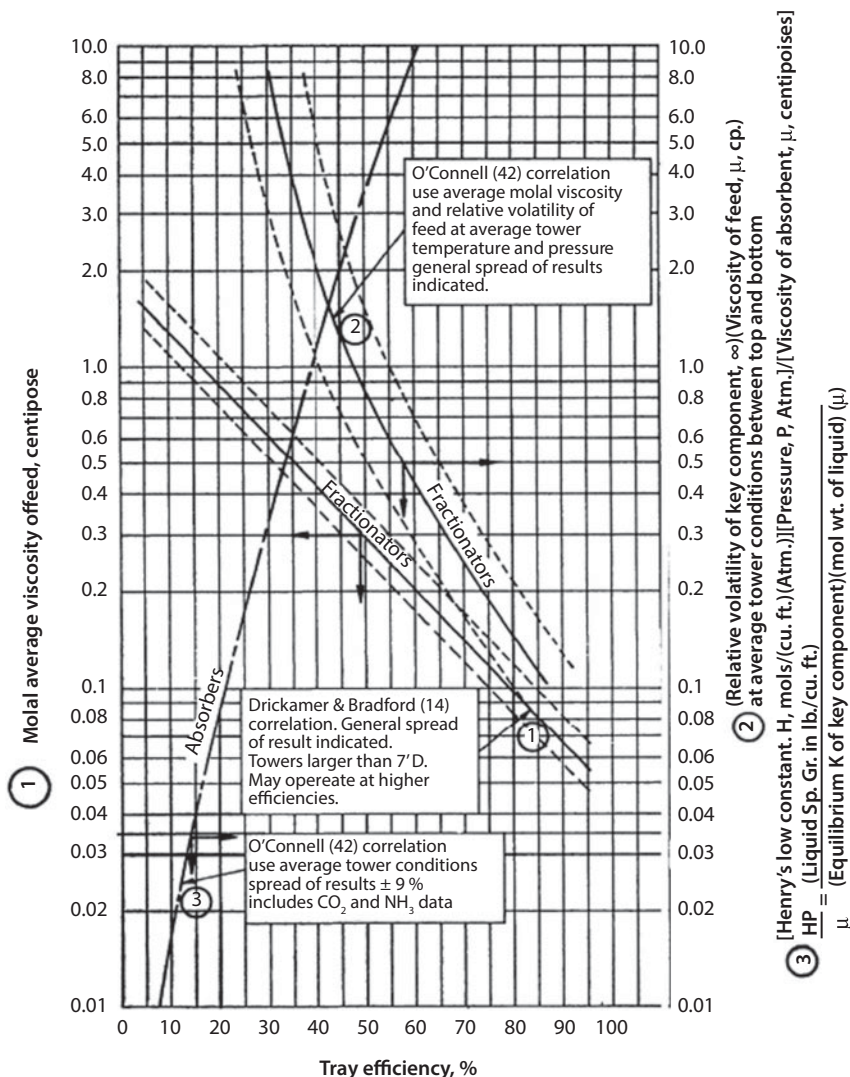


Figure 12.24 Empirical correlations of overall efficiencies for fractionation and absorption.

Table 12.18 Absorption-Stripping Approximation Tray Efficiencies.

Type	Pressure range, psig	Temperature, °F	Range efficiency %
Absorption			
Hydrocarbon Oils & Vapors	0–800	30–130	35–50
Propane – key	100–2,100	–	
Butane – key	100–2,100	–	30–37*–38
Stripping			
Hydrocarbon Oils with Steam	0–130	300–550	50–80
Unsaturates in Oil with closed reboiler	0–50	–	25–35

* Average value

** Hull, R. J. and K. Raymond, *Oil and Gas Journal*, Nov. 9, 1953 – March 15, 1954 [19].

to the absorber (Figure 12.22). The stripping medium may be steam or a dry or inert gas (methane, nitrogen, carbon oxides, hydrogen, etc.). This depends upon the process application of the various components.

1. The rich oil flow rate and absorbed component compositions (this is the only composition of concern, not the oil composition, unless reaction or change takes place under the system conditions) are known. From the temperature levels of the available condensing fluids (water, refrigerant, etc.), determine a column operating pressure which will allow proper condensation of the desirable components at the selected temperature, allowing for proper temperature difference (ΔT) for efficient heat transfer. The condensing pressure (and column operating pressure) may be dictated by the available steam pressure used in stripping or the pressure on the inert stripping gas.
2. From the K charts, determine K_i values for each component at the column temperature and pressure.
3. From a fixed percentage of recovery for key component ($= E_{si}$ for key component), mols component stripped/hr = $G_{mi} = (L_{m+1})(X_{m+1})(E_{si})$
4. Estimate stripping efficiency for components other than the key by:

$$E_{s2} = E_{skey} \left(\frac{K_{key}}{K_2} \right) \quad (12.71)$$

Assume known		$\Sigma X_i =$			
V_o	L_o	V_o/L_o	$(LX)_{i,m+1}/L_o$	$1 + \Sigma X_i$	$E_{s,key} (1 + \Sigma X_i)$
–	Same	–	–	–	–
–	for	–	–	–	–
–	all	–	–	–	–
–	trials	–	–	–	–

$\Sigma Y_i =$			
$\frac{\Sigma G_{mi} \text{ (Step 3)}}{V_o}$	$1 + \Sigma Y_i$	$K_{key} (1 + \Sigma Y_i)$	$\frac{E_{s,key} (1 + \Sigma X_i)}{E_{key} (1 + \Sigma Y_i)}$
–	–	–	–
–	–	–	–
–	–	–	–

Note that no recovery can be greater than 1.0, therefore any value so calculated is recorded as 1.0, indicating that the component is completely stripped from the rich oil. Calculate mols stripped per hour for each component as in Step 2.

5. The minimum stripping medium (steam or gas) to lean oil ratio is estimated by a trial and error procedure based on key component: By assuming several values of V_o , plot V_o/L_o versus $E_{s,key} (1 + \Sigma X_i) / K_{key} (1 + \Sigma Y_i)$. The point where they are equal gives the minimum value for V_o/L_o . This calculation can be thought of as assuming equilibrium at the gas outlet end and being slightly conservative by including the $(1 + \Sigma X_i)$ term. Operation at this point requires infinite number of plates; therefore, values larger than the minimum should be used. For economical as well as reasonable operation, several values of $(V_o/L_o)_{oper}$ should be tried and corresponding plates evaluated.

$$V_o \text{ (operating)} = (\text{assumed } (V_o/L_o)_{oper}) (L_o \text{ inlet}), \text{ mols/hr}$$

6. Calculate S_i for the key component, using the value of $(1 + \Sigma X_i)$ calculated in Step 5. Calculate

$$(1 + \sum X_i) = 1 + \sum \frac{Y_{mi} \text{ (Step 3)}}{V_o \text{ (oper)}}$$

then, $S_{io} = K_i \left(\frac{V_o}{L_o} \right)_{oper} \left(\frac{1 + \sum Y_i}{1 + \sum X_i} \right)$ (12.72)

Sometimes the last term on the right can be neglected.

7. Calculate number of theoretical trays, M.

$$E_{si} = \frac{S_{io}^{M+1} - S_{io}}{S_{io}^{M+1} - 1}$$
 (12.73)

$$(M_o + 1) \log S_{io} = \log \left[\frac{S_{io} - E_{si}}{1 - E_{si}} \right]$$
 (12.74)

8. Actual number of trays at operating reflux:

$$M_{act} = \frac{M_o}{E_o}$$
 (12.75)

9. Calculate for each component corrected amount stripped:

For each component:

$$S_i = K_i \left[\left(\frac{V_o}{L_o} \right)_{oper} \left(\frac{1 + \sum Y_i}{1 + \sum X_i} \right) \right]$$
 (12.76)

$$\left(\frac{V_o}{L_o} \right)_{oper} = \text{fixed in step 5}$$

$(1 + \sum Y_i)$ and $(1 + \sum X_i)$ come from step 6.

10. From Figure 12.23, read $(S^{M+1} - S) / (S^{M+1} - 1) = E_{si}$ for each component at the fixed theoretical required trays and at individual S_i value.

11. For final detail, recalculate mols stripped per hour from new E_{si} values and the total quantities of each component in the incoming rich oil. If values do not check exactly, adjustments can be made in steam rate and $\sum Y_i$ to give exact values. In many cases this accuracy is not justified since the method is subject to some deviation from theoretically correct values.

12. A graphical solution is presented by Edmister [12] and handled like step-wise distillation.

Equilibrium line: starts at origin of X-Y plot.

For assumed X values, calculate Y corresponding for key component from

$$\frac{X_i}{Y_i} = \frac{1}{K_i} \left(\frac{1 + \sum X_i}{1 + \sum Y_i} \right)$$

At lean oil end of tower: $\sum X_i = 0$ and $\sum Y_i = 0$.

Slope of equilibrium line is $Y/X = K_i$

At rich oil end of tower:

$$Y_i = K_i X_i \left(\frac{1 + \sum Y_i}{1 + \sum X_i} \right)_R$$
 (12.77)

where X_i , $\sum X_i$ and $\sum Y_i$ are known. R = rich end.

Operating line:

$$\begin{aligned} \text{Slope} &= L_o / V_o \\ &= \frac{\text{Mols lean oil leaving stripper}}{\text{Mols stripping steam (or gas) entering}} \end{aligned}$$

At lean end, $Y_i = 0$ (or nearly so in most cases); if not, plot accordingly.

12.11.4 Stripping: Determine Stripping-Medium Rate for a Fixed Recovery [12]

1. The composition and quantity of rich oil, and percent recovery of a specified key component are known, also column pressure and temperature.
2. Using Figure 12.23, assume a value for theoretical plates, read S_e corresponding to specified value of recovery E_{si} for key component, since:

$$E_s = (S^{M+1} - S) / (S^{M+1} - 1)$$

Note that with this procedure, the effect of the number of theoretical plates available can be determined. In an existing column where the number of trays is fixed, the theoretical trays can be obtained by evaluating efficiency for the system.

3. The value of $S_e = S_i$ for key component obtained in Step 2 is equal to

$$S_i = K_i \frac{V_o}{L_o} = \left(\frac{1 + \sum Y_i}{1 + \sum X_i} \right)$$

Using key component:

$$\frac{V_o}{L_o} \left(\frac{1 + \sum Y_i}{1 + \sum X_i} \right) \left(\frac{S_i}{K_i} \right), \text{ known}$$

Set up table: use K_i for each component to calculate Column 4.

Component	Mols/hr in Rich Oil	K _i at Col. Condition	$K_i \left\{ \frac{V_o (1 + \sum Y_i)}{L_o (1 + \sum X_i)} \right\}$	E _{si}	Mols/hr Stripped
-	-	-	-	-	-
-	-	-	-	-	-
-	-	-	-	-	-
	Σ				Σ

From values of S_i calculated (=S_e), read E_{si} values from Figure 12.23 at the number of theoretical trays assumed in Step 2. Note that the S_e corresponds to the number of trays selected, hence will give a value for performance of the system under these particular conditions.

- Calculate the mols of each component stripped/hr

$$= (L_{M+1} X_{M+1})_R (E_{si})$$

- Calculate, V_o, mols/hr. of stripping medium required (steam or gas)

From Step 3, $\frac{V_o (1 + \sum Y)}{L_o (1 + \sum X)}$ is known (equals S_i/K_i)

for key component.

Multiply by L_o.

Then, multiply result by

$$\frac{(1 + \sum \text{mols/hr in rich oil} / L_o)}{(1 + \sum \text{mols/hr stripped (Step 3)} / V_o)}$$

This is equal to V_o. Note that V_o also is in the right hand side of the denominator, so fractions must be cleared.

12.12 Absorption: Edmister Method

This method [12] is well suited to handling the details of a complicated problem, yet utilizing the concept of average absorption and stripping factors. It also allows for the presence of solute components in the solvent and the loss of lean oil into the off gas. Reference 12 presents more details than are included here. It is Edmister's original publication of the basic method

for absorbers and strippers, and it also generates the treatment to include distillation towers and presents the same graphical relationships in a slightly modified form.

Absorption: Lean Oil Requirement for Fixed Component Recovery in a Fixed Tower [12]

- The rich gas is known, the number of theoretical trays is fixed (or assumed and corresponding result obtained), the operating pressure and temperature can be fixed.
- For key component and its fixed recovery, E_a, read A_e from Figure 12-23 at the fixed theoretical number of trays, N.

$$E_a = \frac{A_e^{N+1} - A_e}{A_e^{N+1} - 1}$$

- Assume:

- Total mols absorbed
- Temperature rise of lean oil (Normally 20–40 °F)
- Lean oil rate, mols/hr, L_o

- Using Horton and Franklin's [13] distribution relation for amount absorbed (or vapor shrinkage), per tray:

$$= \left(\frac{V_1}{V_{N+1}} \right)^{1/N}$$

$$\text{or: } = \left(\frac{V_1}{V_{N+1}} \right)^{1/N} = \frac{V_i}{V_{i+1}} \quad (12.78)$$

Mols off gas leaving top tray.

$$= V_1 = V_{N+1} - \text{Mols absorbed (assumed)}$$

Mols gas leaving bottom tray No. N

$$= V_N = V_{N+1} (V_1/V_{N+1})^{1/N}$$

Mols gas leaving Tray No. 2 (from top) =

$$V_2 = \frac{V_1}{\left(\frac{V_1}{V_{N+1}}\right)^{1/N}}$$

Liquid leaving top tray No. 1 = $L_1 = L_o + V_2 - V_1$

where

V_2 = vapor leaving tray No. 2 from top, mols/hr

L_o = lean oil entering (assumed completely free of rich gas components), mols/hr

L_N = liquid leaving bottom tray, mols/hr

V_N = vapor leaving bottom tray, mols/hr

Liquid leaving bottom tray

$$= L_4 = L_o + \text{Mols absorbed (assumed)}$$

5. Calculate: At top, L_1/V_1

At bottom, L_N/V_N

6. Use Horton-Franklin method to estimate temperatures at tower trays:

$$\frac{T_N - T_i}{T_N - T_o} = \frac{V_{N+1} - V_{i+1}}{V_{N+1} - V_1} \quad (12.79)$$

where

T_o = lean oil temperature, °F

T_N = bottom tray temperature, °F

T_i = tray, i temperature, °F

T_{N+1} = inlet rich gas temperature, °F

These relations assume constant percent absorption per tray, and temperature change proportioned to the vapor contraction per tray. For estimating use only.

Temperature bottom tray = $T_N = T_{N+1} +$ (assumed rise)

Temperature top tray

$$= T_N - (\text{assumed rise}) \left(\frac{V_{N+1} - V_{\text{Tray 2}}}{V_{N+1} - V_1} \right)$$

7. Read the K values from equilibrium charts for components in feed at temperatures of (a) top tray and (b) bottom tray.

8. Calculate A_{Ti} and A_{Bi} for each component.

$$A_{Ti} \text{ (for top conditions)} = L_i / (K_i V_i)$$

$$A_{Bi} \text{ (for bottom conditions)} = L_N / (K_i V_N)$$

where:

A_{Ti} = absorption factor for each component at conditions of top tray

A_{Bi} = absorption factor for each component at conditions of bottom tray.

9. Read A_e values corresponding to A_{Ti} and A_{Bi} values from Figure 12.25.

10. Read E_{ai} values for fraction absorbed from Figure 12.23 using the A_e values of Step 9 and the fixed or assumed number of theoretical trays.

11. Calculate the mols of each component absorbed by:

(Mol component in inlet rich gas) (E_{ai})

Suggested tabulation:

Component	Mols Rich		K			Absorption Factors			E_{ai} , Frac.	Mols
	Gas In	Top	Bottom	A_T	A_B	A_e	Absorbed	Absorbed		
-	-	-	-	-	-	-	-	-	-	
-	-	-	-	-	-	-	-	-	-	
-	-	-	-	-	-	-	-	-	-	

12. If the result does not yield the desired amount of the key component absorbed, then re-assume the lean oil quantity, L_o and recalculate. Adjustments may have to be made separately or simultaneously in the assumed absorption quantity until an acceptable result is obtained. After two or three trials a plot of the key variables will assist in the proper assumptions.

Absorption: Number of Trays for Fixed Recovery of Key Component

Here we also consider the more general case when the lean oil contains some of the components to be absorbed from the entering gas. The relationships are most conveniently written as follows [12], for a given component:

$$v_1 = f_s l_o + (1 - f_a) v_{n+1} \quad (12.80)$$

$$f_s = \frac{S_e^{n+1} - S_e}{S_e^{n+1} - 1} \quad (12.81)$$

$$f_a = \frac{A_e^{n+1} - A_e}{A_e^{n+1} - 1} \quad (12.82)$$

Re-arranging Equation 12.82 gives

$$1 - f_a = \frac{A_e - 1}{A_e^{n+1} - 1} \quad (12.83)$$

Substituting Equations 12.81 and 12.82 into Equation 12.80 gives

$$v_1 = \left(\frac{S_e^{n+1} - S_e}{S_e^{n+1} - 1} \right) l_o + \left[1 - \left(\frac{A_e^{n+1} - A_e}{A_e^{n+1} - 1} \right) \right] v_{n+1} \quad (12.84)$$

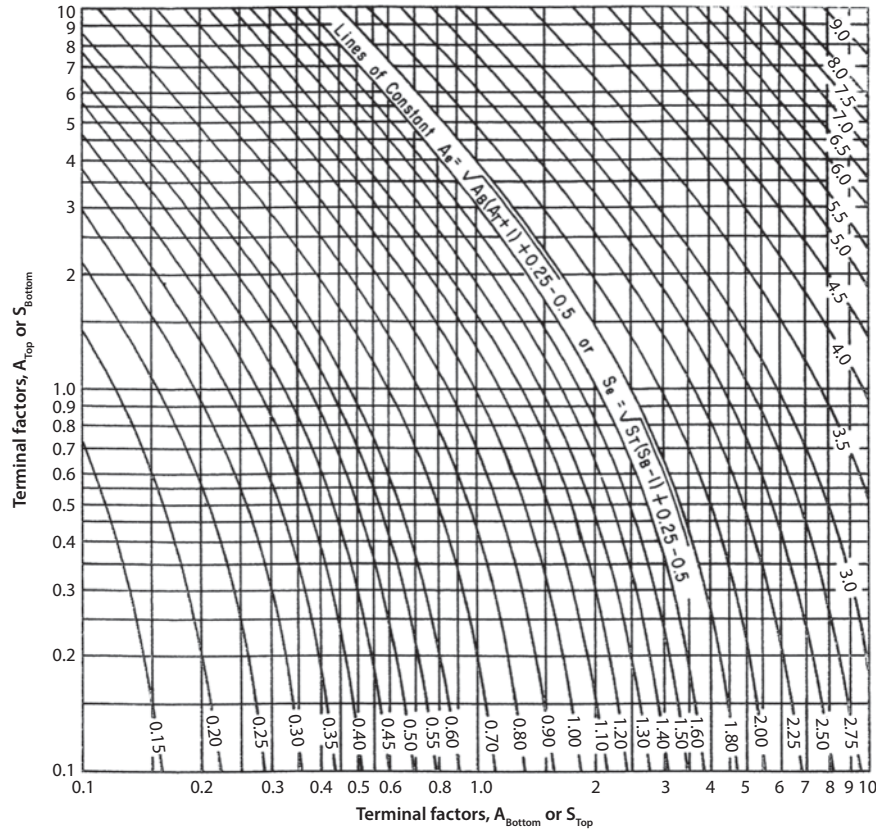


Figure 12.25 Effective absorption and stripping factors used in absorption, stripping and fractionation as functions of effective factors. Source: Edmister, W. C., *Petroleum Eng.* Sept., (1947) to Jan. (1948).

which can be written as

$$v_1 = \left[\left(1 - \frac{S_e - 1}{S_e^{n+1} - 1} \right) \right] l_o + \left[\frac{A_e - 1}{A_e^{n+1} - 1} \right] v_{n+1} \quad (12.85)$$

where

- v_{1i} = molar gas flow rate of component “i” leaving plate 1 in the absorber
- l_{oi} = molar flow of component “i” in entering liquid to the absorber
- v_{n+1i} = molar gas flow rate of component “i” in entering gas to the absorber
- f_{si} = the fraction of V_{n+1i} that is absorbed by the liquid phase
- f_{ai} = the fraction of V_{n+1i} that is absorbed by the liquid
- n = absorber theoretical number of trays, also = N
- m = stripper theoretical number of trays, also = M

A material balance on the key component fixes v_1 , l_o and v_{n+1} for the key. A_e is estimated after A_T and A_B are calculated using approximate conditions at the top and bottom, with a multiple of the minimum solvent rate,

which is estimated by assuming equilibrium at the bottom of the tower. S_e is estimated from S_T and S_B . Note that $S_T = 1/A_T$ and $S_B = 1/A_B$. A trial and error solution for the number of theoretical stages is effected by using Equation 12.84 (or 12-85 and Figure 12-23). Values of v_1 for the non-keys can be calculated by using these relationships directly the calculated value of n ; if necessary, the entire procedure can be repeated, using the better estimates of the component flow rates in the leaving streams that were estimated in the first iteration.

Lean Oil

The selection of lean oil for an absorber is an economic study. A light lean oil sustains relatively high lean oil loss, but has the advantage of high mols/gal compared to a heavier lean oil. The availability of a suitable material has a large influence on the choice. For example, a lean oil three carbon numbers heavier than the lightest component absorbed is close to optimum for some applications. In natural gas plant operations, a lean oil heavier by about 10–14 carbon numbers has been reported [18].

Presaturators

A presaturation to provide lean oil/gas contact prior to feeding the lean oil into the tower is a good way of getting more out of an older tower. Absorber tray efficiencies are low, and therefore a presaturation that achieves equilibrium can provide the equivalent of a theoretical tray. This can easily equal 3–4 actual trays [18].

Example 12-4: Absorption of Hydrocarbons with Lean Oil

The gas stream shown in Table 12.19 is fed to an isothermal absorber operating at 90°F and 75 psia. 90% of the n-butane is to be removed by contact with a lean oil stream consisting of 98.7 mol% non-volatile oil and the light components shown in Column 2 of Table 12.19. Estimate the composition of the product streams and the required number of theoretical stages if an inlet rate of 1.8 times the minimum is used.

Solution:

1. Initial estimates of extent of absorption of non-keys.

As a rough approximation, assume the fraction absorbed of a given component is inversely proportional to its K value (Equation 12.70). For example:

$$n-C_4, \text{ in off gas} = 33.6 - (0.9)(33.6) = 3.36$$

$$C_1, \text{ in off gas} = 1,639 - (0.9)\left(\frac{0.65}{42.5}\right)(1,639.2) = 1,616.6$$

$$C_2, \text{ in off gas} = 165.8 - (0.9)\left(\frac{0.65}{7.3}\right)165.8 = 152.5$$

The other estimates in column 5 of Table 12.19 are calculated in a similar manner. Note that the C_{5s} are assumed to be completely absorbed for this first iteration.

2. Inlet rate of rich oil.

The maximum mol fraction n- C_4 in the leaving liquid is taken as that in equilibrium, with the incoming gases. Thus, for n- C_4 ,

$$\frac{l_n}{(L_n)_{\min}} = \frac{0.017}{0.65} = 0.02615$$

A material balance of n- C_4 yields

$$l_n = 0.002 L_o + (0.9) 33.6$$

With the absorption efficiencies assumed above,

$$L_n = L_o + 126.34$$

Combining the above equations yields the estimate of the minimum lean oil rate:

$$\frac{0.002(L_o)_{\min} + (0.9)33.6}{(L_o)_{\min} + 126.38} = 0.02615$$

or $(L_o)_{\min} = 1,115.3$ mols/hr

Thus, $L_o = 1.8(1,115.3) = 2,007.5$ mols/hr

3. Effective Absorption Factor for n- C_4 .

The total rich oil out is estimated as

$$L_n = 1,975 + 2,007.5 - 1,848.66 = 2,133.84$$

The absorption factors are calculated by

$$A_T = 2,007.5 / (.65)(1,848.66) = 1.671$$

$$A_B = 2,133.84 / (.65)(1,975) = 1.662$$

$$A_e = \sqrt{A_B(A_T + 1) + 0.25} - 0.5$$

$$A_e = \sqrt{1.662(2.671) + 0.25} - 0.5 = 1.665$$

The stripping factor, S_e , is taken as $1/A_e = 0.6006$

4. Calculation of the required number of theoretical stages.

Using Equation 12.84 for n-butane,

$$3.36 = \left(\frac{0.6006^{n+1} - 0.6006}{0.6006^{n+1} - 1} \right) 4.0 + \left[1 - \left(\frac{1.665^{n+1} - 1.665}{1.665^{n+1} - 1} \right) \right] 33.6$$

which is equivalent to

$$3.36 = \left[1 - \left(\frac{0.6006 - 1}{0.6006^{n+1} - 1} \right) \right] 4.0 + \left(\frac{1.665 - 1}{1.665^{n+1} - 1} \right) 33.6$$

Solving for n by trial and error yields, $n = 5.12$

5. Calculation of absorption of non-keys.

Equation 12.85 is used with $n = 5.12$ to calculate v_1 , as for example, for i-butane,

$$A_T = 1.233$$

$$A_B = 1.227$$

Table 12.19 Calculations Summaries for Example 12.4.

Component	90 °F K 75 psia	Feed gas in (mols/hr)	Lean oil in (mol. Fraction)	Initial estimate of net amount absorbed (mols/hr)	Off-Gas				Lean oil in (mols/hr)	Rich oil out (mols/hr)
					Initial estimate (mols/hr)	After first iteration (mols/hr)	After second iteration (mols/hr)	After third iteration (mols/hr)		
Methane	42.5	1,639.2	-	22.6	1,616.6	1,597.5	1,598.4	1,598.4	-	40.8
Ethane	7.3	165.8	-	13.3	152.5	141.2	141.8	141.8	-	24.0
Propane	2.25	94.9	-	24.67	70.23	49.84	50.76	50.76	-	44.14
i-Butane	0.88	17.8	0.001	11.83	5.97	3.10	3.13	3.13	1.91	16.58
n-Butane	0.65	33.6	0.002	30.24	3.36	3.36	3.36	3.36	3.83	34.07
i-Pentane	0.28	7.9	0.004	7.9	0	2.08	2.03	2.03	7.66	13.53
n-Pentane	0.225	15.8	0.006	15.8	0	2.51	2.44	2.44	11.49	24.85
Heavy Oil	0	-	0.987	0	0	0	0	0	1,889.83	1,889.83
		1,975.0	1.000	126.34	1,848.66	1,799.57	1,801.92	1,801.92	1,914.72	2,087.78

$$A_e = \sqrt{1.227(2.333) + 0.25} - 0.5 = 1.229$$

$$S_e = \frac{1}{1.229} = 0.8137$$

$$v_o = 17.8$$

$$l_o = (0.001)(2,005.7) = 2.01$$

$$v_1 = \left[1 - \left(\frac{0.8137 - 1}{0.8137^{6.12} - 1} \right) \right] 2.01$$

$$+ \left(\frac{1.229 - 1}{1.229^{6.12} - 1} \right) 17.8 = 3.097$$

$$l_n = 17.8 + 2.01 - 3.097 = 16.71$$

The remaining non-keys in the off-gas are calculated in a similar manner and are tabulated in Column 6 of Table 12.19. Note that the calculated values are somewhat different from the assumed values in Column 5.

6. Second Iteration.

Using the previous calculated values, the net amount absorbed is $1,975 - 1,799.59 = 175.41$ mols/hr. The minimum rate of lean oil is calculated from

$$\frac{(0.002)(L_o)_{\min} + 0.9(33.6)}{(L_o)_{\min} + 175.41} = 0.02617$$

from which $(L_o)_{\min} = 1,061.2$ mols/hr and

$$L_o = 1.8(1,061.2) = 1,910.2 \text{ mols/hr}$$

An overall material balance gives $L_n = 2,085.6$. The effective absorption factor for n-C₄ is $A_e = 1.627$, and $S_e = 0.6145$, n is calculated from

$$3.36 = \left[1 - \left(\frac{0.6145 - 1}{0.6145^{n+1} - 1} \right) \right] 3.82$$

$$+ \left(\frac{1.627 - 1}{1.627^{n+1} - 1} \right) 33.6$$

from which $n = 5.20$ theoretical number of stages.

The non-key components are computed and tabulated in Column 7 of Table 12.19.

7. Third Iteration.

A third iteration gave $(L_o)_{\min} = 1,063.73$, $L_o = 1,914.72$, $L_n = 2,087.8$, and $V_1 = 1,801.92$, with no change in the calculated off-gas component flows.

The stripping calculations are handled in a manner similar to the steps above, and using the figures indicated.

Intercooling for Absorbers

Most absorbers require some intercooling between stages or trays to remove heat of absorption and to provide internal conditions compatible with proper or required absorption. Some temperature rise (10-30°F) is usually designed into the initial conditions. The rise above this must be handled with intercoolers.

The total intercooler duty is the difference between the total heat of the rich gas and lean oil and the total heat out of the off-gas and rich oil all at the terminal calculated or design conditions. The total duty is often divided between several coolers placed to recool the oil as it passes down the column. If intercoolers are not used, then the absorption cannot meet the design terminal outlet conditions and the quantity of material absorbed will be reduced. If the intercooling is too great so as to sub-cool, then greater absorption may be achieved, but this can be controlled by the intercooler operation.

A second approach to the same result involves the same requirements as for a balanced "heat" design; the heat of absorption of the actual components absorbed must equal the sum of the heat added to the lean oil and to the lean gas. For hydrocarbon materials these factors can be developed by using total heats.

The relation of Hull and Raymond [19] considers heat loss through the column wall, and indicates that either the total heat of absorption or the rich oil outlet temperature for system balance can be calculated. Thus, if a reasonable temperature balance is not obtained, the heat load for the intercoolers can be set.

$$W_{Lo} C_{pLo} (T_{Ro} - T_{Lo}) + W_{DG} C_{pDG} (T_{DG} - T_{IG})$$

$$+ W_s C_{ps} (T_{Ro} - T_{IG}) \quad (12.86)$$

$$= \Delta H_s - 0.024 U A'' (T_{AV} - A_{AMB})$$

Figure 12.26 presents actual total heats of absorption based on experimental studies [19]. As long as the hydrocarbon absorption is in the range of 80-120°F, the values read from the graph should apply.

Estimation of discharge gas temperature may be made from Figure 12.27 based on test data.

The design of absorbers has not received the empirical design guidelines study so prevalent in distillation

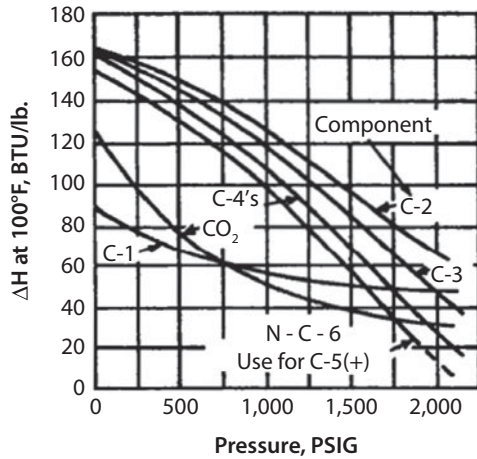


Figure 12.26 Component heats of absorption, Source: Hall, R. J., and K. Raymond, *Oil & Gas Journ.*, Nov. 9, (1953) thru Mar. 15 (1954).

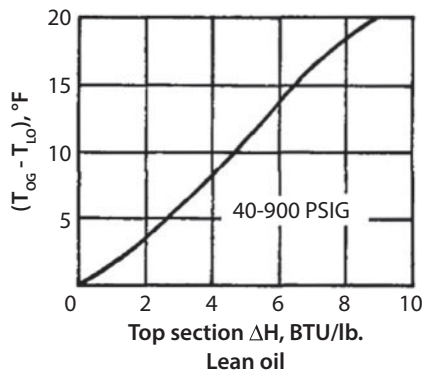


Figure 12.27 Hydrocarbons systems, overhead gas minus lean oil temperature for components absorbed in top. “theoretical” tray (or top actual three trays.) Used by permission, Hall, R. J., and K. Raymond, *Oil & Gas Journ.* Nov. 9 (1953) thru Mar. 15 (1954).

problems. The graph of Hutchinson [20], Figure 12.28, is convenient to examine a problem to determine preliminarily the effects of design. This curve is compatible with the conventional absorption factor graphs. The percent extraction gives a quick evaluation of the possibilities of accomplishing the desired absorption. As the number of trays in the absorber is increased, the amount of heavier material (larger A values) absorbed increases greater than the lighter components (lower A values). More heavier materials are also absorbed as the temperature of absorption is lowered. Thus, a cold lean oil has more capacity per gallon than a warm oil. This requires a study of the entire process and not just the one unit. Heat economy, oil flows, and tower costs all enter into a full evaluation of the absorber as it fits into the plant system.

Many designs are set up by assuming the number of theoretical trays, using the best available information

for tray efficiencies and then calculating the expected performance. A series of such studies might be made.

12.12.1 Absorption and Stripping Efficiency

Unfortunately, the efficiencies for tray and overall column operation are incomplete and nullify to a certain extent some very high-quality theoretical performance design. Tray efficiencies may be estimated by Figure 12.24 or Table 12.18. Table 12.20 gives a summary of Sherwood’s absorption and stripping calculation method.

Example 12.5: Determine the Number of Trays for Specified Product Absorption

A gas stream is to have the ethylene removed by absorption in a lean oil of molecular weight 160, sp. gr. 0.825. The inlet gas is at 70 psig and 100°F and the oil is at 80°F. The gas rate is 16,000,000 scf/day (60°F). Examine the tower performance for 98% ethylene recovery at 1.25 times the minimum L_o/V_N .

Feed Gas	
Component	Mol or Volume %
H ₂	18.5
CH ₄	22.3
C ₂ H ₄	20.3
C ₂ H ₆	0.5
C ₃ H ₆	22.0
C ₃ H ₈	0.7
n- C ₄ H ₁₀	2.5
n- C ₅ H ₁₂	13.0
	100.0

Determine the oil rate and the number of theoretical and actual trays required. (Note: this example illustrates that unreasonable results must be examined, not just accepted.)

Solution

$$\begin{aligned}
 1. \text{ Inlet rich gas rate} &= \frac{16,000,000}{359 \left(\frac{14.7}{14.7} \right) \left(\frac{460+60}{460+32} \right)} (24) \\
 &= 1,756 \text{ mols / hr}
 \end{aligned}$$

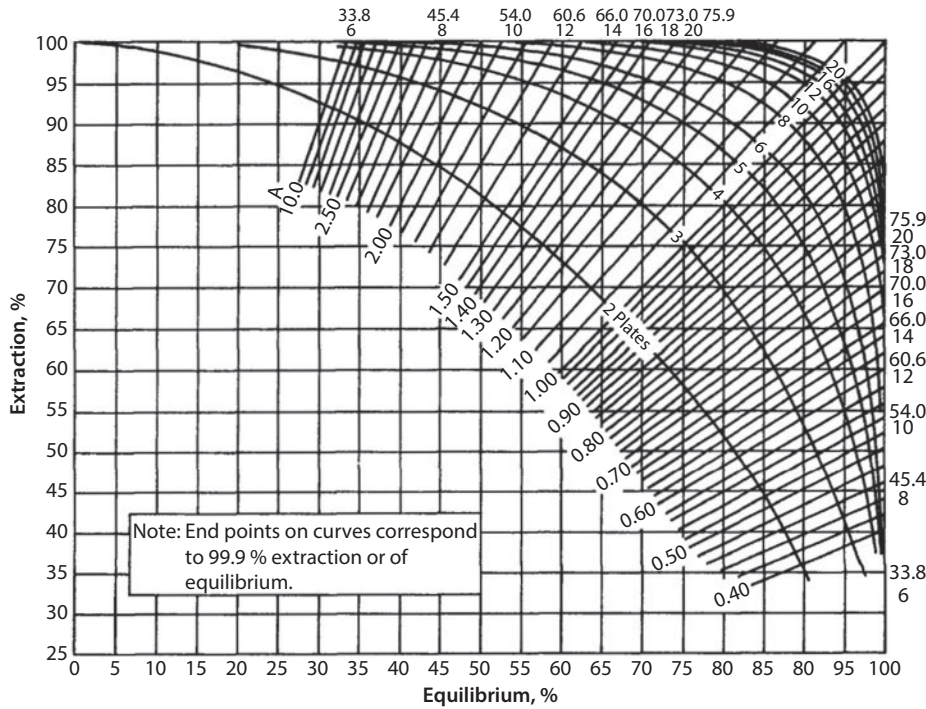


Figure 12.28 Absorption equilibrium curve. (Source: Hutchison, A. J. L., *Petroleum Refiner*, V. 29 (1950), p. 100, Gulf Pub. Co.)

Mols ethylene in = (20.5/100) (1,756) = 360 mols/hr

Mols ethylene in outlet gas = (100 - 98/100)(360) = 7.20 mols/hr

Mols ethylene absorbed in oil = 360 - 7.2 = 352.8 mols/hr

2. Specified ethylene separation = 0.98 = E_{ai} =

$$\frac{\text{Mols in} - \text{Mols out}}{\text{Mols in}}$$

3. Minimum L/V for ethylene:

$$\left(\frac{L_o}{V_{N+1}} \right)_{\min} = K_i E_{ai}$$

Average tower conditions for K:

$$\text{Temperature} = (100 + 80)/2 = 90^\circ\text{F}$$

Pressure: allow 20 psi pressure drop, then top pressure would be 70 - 20 = 50 psig

$$\text{Average: } (50 + 70)/2 = 60 \text{ psig}$$

K (ethylene) at 60 psig and 90 °F = 11.5 (from equilibrium charts).

$$\left(\frac{L_o}{V_{N+1}} \right)_{\min} = (11.5)(0.98) = 11.28$$

4. Operating $(L_o/V_{N+1})_o = (1.25) (11.28) = 14.1$

5. Operating

$$A_{io} = \left(\frac{L_o}{V_{N+1}} \right)_o \left(\frac{1}{K_i} \right) = \frac{14.1}{11.5} = 1.227$$

6. Theoretical number of trays at operating $(L_o/V_{N+1})_o$:

$$E_{ai} = \frac{A^{N+1} - A_i}{A^{N+1} - 1} = \frac{(1.227)^{N+1} - 1.227}{(1.227)^{N+1} - 1} = 0.98$$

$$(N+1) \log 1.227 = \log \left[\frac{1.227 - 0.98}{1 - 0.98} \right]$$

$$N = 11.29$$

7. Actual number of plates at operating $(L_o/V_{N+1})_o$:

Efficiency of oil at 90°F, and sp. gr. of 0.825 corresponding to API of 40.

Viscosity = 0.81 centipoise

For O'Connell's efficiency correlation, Figure 12.24.

$$\frac{0.825(62.3 \text{ lb / ft}^3)}{(11.5)(160)(0.81)} = 0.0345$$

Reading curve (3), Eff. = 14%

Table 12.20 Summary of Sherwood Absorption and Stripping Calculation Method.

<p>This method is a combination of graphical and analytical using “equilibrium line” and “operating line” concepts thus illustrating diffusional driving force.</p>	<p>Subscripts L and R refer to compositions at lean and rich ends, respectively. L_o, V_o and V_{n+1} refer to lean oil stripping steam and wet gas quantities, respectively.</p>
<p>All compositions (X and Y) are referred to constant and known streams, such as: inlet wet gas to absorber, lean oil to absorber or from stripper, and inlet stream to stripper.</p>	<p>Method is applied in both absorption and stripping calculations by making preliminary calculations to permit drawing XY diagram for key component and using graphical results to complete calculations.</p>
<p>Absorption</p>	<p>Stripping</p>
<p>Equations:</p>	<p>Equations:</p>
$E_a = \frac{Y_R - Y_L}{Y_R - Y_o} = \frac{A^{n+1} - A}{A^{n+1} - 1}; A = \left[\frac{L_o}{KV_{n+1}} (1 + \sum X) \right]^*$	$E_s = \frac{X_R - X_L}{X_R - X_o} = \frac{S^{m+1} - s}{S^{m+1} - 1}; S = \left[\frac{KV_o}{L_o} \left(\frac{1 + \sum Y}{1 + \sum X} \right) \right]^*$
<p>The absorption factor A has L_o/V_{n+1} as the ratio of the lean oil to the inlet gas and $(1 + \sum X)$ term changes the lean oil to the rich oil. K is determined at an average oil temperature.</p>	<p>The stripping factor S has V_o/L_o as the ratio of stripping medium to lean oil and $(1 + \sum Y)/(1 + \sum X)$ term corrects for the ratio for the transfer components from the liquid to the gas. K is evaluated at an average oil temperature.</p>
<p>Estimate $\sum X$ and calculate the amounts of each component absorbed by the above equation. Then make XY diagram for the key component.</p>	<p>Estimate $\sum X$ and $\sum Y$ at the rich end and calculate the amounts of each component stripped by the above equation. Then make XY diagram for the key component.</p>
<p>XY Diagram</p>	<p>XY Diagram</p>
<p>Equilibrium line is drawn with the slope at origin and values of X_R and Y_o at rich end, both being obtained from the equilibrium equation</p>	<p>Equilibrium line is drawn with the slope at origin and values of X_R at rich end, both being obtained from the equilibrium equation</p>
$K = \frac{Y}{X} \left(\frac{1 + \sum X}{\sum Y} \right)$	$K = \frac{Y}{X} \left(\frac{1 + \sum X}{1 + \sum Y} \right)$
<p>At the lean end, $\sum X$, and slope of the equilibrium line = $Y/X = K_L (\sum Y_L)$.</p>	<p>At the lean end $\sum X = 0$ and $\sum Y = 0$, and slope of the equilibrium line = $Y/X = K_L$</p>
<p>At the rich end, values of Y_R, X_o and $\sum Y_o$ are known</p>	<p>At the rich end, values of Y_R, $\sum X_R$ and $\sum Y_R$ are known</p>
$X_R = \frac{Y_R}{K_R} \left(\frac{1 + \sum X_R}{\sum Y_R} \right)$	$Y_R = K_R X_R \left(\frac{1 + \sum Y_R}{1 + \sum X_R} \right)$
<p>Operating line is drawn with the slope and intercept on the Y axis, or the slope and trial to get proper number of steps.</p>	<p>Operating line is drawn with the slope and intercept on the X axis, or the slope and trial to get proper number of steps.</p>
$slope = \frac{L_o}{V_{n+1}} = \left(\frac{\text{mols of lean oil entering absorber}}{\text{mols of wet gas entering absorber}} \right)$	$slope = \frac{L_o}{V_o} = \left(\frac{\text{mols of lean oil leaving stripper}}{\text{mols of stripping steam entering stripper}} \right)$
<p>Final calculations:</p>	<p>Final calculations:</p>
<p>Repeat the analytical or graphical calculations with necessary adjustments until results of both are the same.</p>	<p>Repeat the analytical or graphical calculations with necessary adjustments until results of both are the same.</p>
<p>* These equations which are expressions of the L/V ratio at rich end and the average K, are consistent with the graphical calculation procedure for the key component.</p>	

(Source: Edmister, W. C., Hydrocarbon absorption and fractionation process design methods, part 6., The Petroleum Engineer, October, 1947).

This value is low, but agrees generally with the specific data in O'Connell's [21] report. Although Drickamer's data are not so specific for absorption, the graph of this correlation gives Eff. = 20% for the 0.81 cP. Because no better information is available, use Eff. = 15%.

$$\text{Actual number of trays, } N_o = N/E_o = 11.29/0.15 = 75.26$$

$$\text{Use } N_o = 75 \text{ trays}$$

$$\text{Lean oil rate} = L_o = A_i (K_i) (V_{N+1})_o = (1.227) (11.5) (1,756)$$

$$L_o = 24,788 \text{ mols/hr}$$

$$\text{GPM oil} = \frac{25,000(160)}{(8.33)(0.825)(60)} = 9,700$$

This is unreasonable, and is due to the effect of:

- Operating pressure being too low, thus giving a high K value
- Ethylene being light component and difficult to absorb.
- Temperature being too high.
- Recalculation of steps 3 through 8.

Assume operating pressure is 700 psig, $K = 1.35$.

Note that this same K value could have been achieved by lowering the operating temperature to -90°F . This is also not practical from the oil standpoint or even from the economics of operating the entire system and refrigeration system at this level, unless (1) the refrigeration is available and (2) a suitable oil is available.

$$\text{Min } (L/V) = (1.35) (0.98) = 1.32$$

$$\text{Operating } (L/V_{N+1})_o = (1.25) (1.32) = 1.65$$

$$\text{Operation } A_{i_o} = 1.65/1.35 = 1.222$$

Theoretical number of trays at operating $(L_o/V_{N+1})_o$:

$$(N+1) \log 1.222 = \log \left[\frac{1.222 - 0.98}{1 - 0.98} \right]$$

$$N = 11.42 \text{ trays}$$

$$\text{Efficiency: } \frac{(0.825)(62.3)}{(1.35)(160)(0.81)} = 0.294$$

Reading curve 3, Eff. = 29%

Actual number of trays = $11.42/0.29 = 39.4$. Say 40 trays.

Lean oil rate = $(1.222) (1.35) (1,756) = 2,900$ mols/hr

$$\text{GPM} = \frac{(2,900)(160)}{(8.33)(0.825)(60)} = 1,125$$

This is still a large quantity of oil to absorb the ethylene. Under some circumstances it might be less expensive to separate the ethylene by low-temperature fractionation.

Example 12.6: Determine Component Absorption in a Fixed-Tray Tower

An existing 40-tray tower is to be examined to determine the absorption of a rich gas of the following analysis:

Component	Mols/hr	Mol wt	104 °F K_i 176 psia
H ₂	500.0	2	59.0
CH ₄	20.9	16	56.0
C ₂ H ₄	131.5	26	8.1
CO	230.0	28	12.3
C ₃ H ₄	3.5	40	0.07
C ₄ H ₂	4.1	50	0.009
	890.0		

- The key component is methyl acetylene, C₃H₄. Recovery will be based on 96.5% of this material.

The tower average temperature will be assumed = 104°F.

The operating average pressure will be = 161 psig.

- The K_i values are tabulated for the conditions of (1), and were determined from laboratory test data for the special solvent oil being considered.

$K_i = 14.7 (H_i)/176$, where H_i is Henry's constant expressed as atm/mol fraction for each component. Note that conventional K charts are only applicable to hydrocarbon oil systems, and do not apply for any special solvents.

- Calculate tray efficiency for C₃H₄.

Using O'Connell's correlation:

(solvent) at 104°F = 2.3 cP

Sr. gr. = 1.0

Mol. wt. solvent = 180

$K = 0.07$

$$\text{HP} = \frac{\text{Sp.Gr. solvent}}{(K_{C_3H_4})(\text{M.W. solvent})} = \frac{(1.0)(62.3)}{(0.07)(180)} = 4.94$$

$$\frac{HP}{\mu} = \frac{4.94}{2.3} = 2.15$$

Efficiency = 46.5% (From Figure 12-23)

Use: 45%

Actual number trays in column = 40

Theoretical number of trays based on 45% efficiency =
 $(40) (0.45) = 18$

4. Using $E_{ai} = 96.5\%$ for C_3H_4 , read A_i from Figure 12.23.

At $n = 18$

$$A_e = A_i = 1.04$$

$$A_i = L_o / KV_{N+1}$$

$$V_{N+1} = 890 \text{ mols/hr}$$

$$L_o = (1.04) (0.07) (890) = 64.8 \text{ mols/hr}$$

$$L_o / V_{N+1} = 64.8 / 890.0 = 0.0728$$

5.

Component	Inlet		$A_i = \frac{L_o}{V_{N+1} K_i}$	E_{ai}
	$Y_{(N+1)i}$	Mols/hr		
H ₂	0.562	500.0	0.001235	0.001235
CH ₄	0.0235	20.9	0.00130	0.00130
C ₂ H ₂	0.1478	131.5	0.009	0.009
CO	0.258	230.0	0.00592	0.00592
C ₃ H ₄	0.00393	3.5	1.04	0.965
C ₄ H ₂	0.00462	4.1	8.1	1.000
	0.99985	890.0		
	Mols/hr		Mols/hr	
Component	Absorbed	X_{iR}	Off Gas	$Y_{li} \text{ (out)}$
H ₂	0.617	0.00953	*499.383	0.561
CH ₄	0.0272	0.00042	20.8728	0.02348
C ₂ H ₂	1.185	0.0183	130.315	0.14647
CO	1.36	0.021	228.64	0.2565
C ₃ H ₄	3.37	0.052	0.13	0.00014
C ₄ H ₂	4.1	0.0633	0	0
	10.659	0.1645		

*These are subtraction differences and do not infer that the results are this accurate.

Typical calculations: for hydrogen

$$A_i = 0.0728 / 59.0 = 0.001235$$

From Figure 12.23 at $n = 18$ theoretical number of trays, and $A_i = 0.001235$ read E_{ai} , except that in this low

region some values cannot be read accurately. When A_i is considerably less than 1.0, use $E_{ai} = A_i$ (very little light material recovered), and when A_i is quite a bit larger than 1.0, use $E_{ai} = 1.0$ (heavy material mostly recovered).

$$\begin{aligned} \text{Mols component absorbed/hr} &= (V_{N+1}) (Y_{(N+1)i}) E_{ai} \\ &= (890) (0.562) (0.001235) \\ &= 0.617 \end{aligned}$$

$$\begin{aligned} \text{Mols component absorbed/mol lean oil} &= X_{iR} = \\ &= 0.0617 / 64.8 = 0.00953 \end{aligned}$$

$$\begin{aligned} \text{Mols of component in off-gas out top of absorber:} \\ &= 500.0 - 0.617 = 499.383 \text{ mols/hr} \end{aligned}$$

Mols component in, out top of absorber/mol inlet rich gas

$$E_{ai} = \frac{Y_{N+1} - Y_{li}}{Y_{N+1} - Y_o^*} \quad \text{Let } Y_o^* = 0$$

$$0.001235 = \frac{0.562 - Y_{li}}{0.562}$$

$$Y_{li} = 0.5614$$

6. Correcting values and recalculating

Component	Inlet		$A_i = \frac{L_o (1 + \sum X_{iR})}{V_{N+1} K_i}$	E_{ai}
	$Y_{(N+1)i}$	Mols/hr		
H ₂	0.562	500.0	0.00144	0.00144
CH ₄	0.0235	20.9	0.001513	0.001513
C ₂ H ₂	0.1478	131.5	0.01048	0.01048
CO	0.258	230.0	0.00689	0.00689
C ₃ H ₄	0.00393	3.5	1.21	0.98
C ₄ H ₂	0.00462	4.1	9.43	1.00

Component	Mols/hr		Off Gas	
	Absorbed	X_{iR}	Mols/hr	Y_{li}
H ₂	0.72	0.0111	499.28	0.561
CH ₄	0.0317	0.000488	20.869	0.0232
C ₂ H ₂	1.38	0.0213	130.12	0.1463
CO	1.585	0.0244	228.415	0.257
C ₃ H ₄	3.43	0.0529	0.07	0.00008
C ₄ H ₂	4.1	0.0633	0	0
	11.246	0.1734	878.754	0.9775

Typical calculations, using hydrogen:

$$A_i = \frac{L_O}{V_{N+1}(K_i)} \left(1 + \sum X_{iR}\right)$$

$$= \frac{0.0728}{59.0} (1 + 0.1645) = 0.00144$$

$$\begin{aligned} &\text{Mols component absorbed/hr} \\ &= (0.00144) (500) = 0.72 \end{aligned}$$

$$\begin{aligned} &\text{Mols component absorbed/mol lean oil} \\ &= 0.72/64.8 = 0.0111 \end{aligned}$$

$$\begin{aligned} &\text{Mols of component in off-gas out top of absorber:} \\ &= 500.0 - 0.72 = 499.28 \end{aligned}$$

These results do not justify recalculation for greater accuracy. Note that 98% of the C_3H_4 is absorbed instead of 96.5% as initially specified. This could be revised by reassuming a lower (slightly) oil rate, but this is not considered necessary.

The off-gas analysis Y_i represents mols gas out per mol entering rich gas.

For a new design, a study should be made of number of trays against required lean oil for a given absorption.

12.13 Gas Treating Troubleshooting

Troubleshooting of the glycol unit can be simplified, if the unit is appropriately instrumented, operating records, glycol analyses, process flow sheets and drawings of vessel internals are readily available [22, 23]. Interpreting the records requires knowledge of the design condition for the plant. Additionally, major changes in pertinent variables such as inlet gas flow rate, temperature or pressure require determination of a new set of optimum operating conditions. Branan [18] illustrated the corrective measures for the possible causes of common problems in glycol plant as follows:

12.13.1 High Exit Gas Dew Point

- Change in gas flow rate, temperature or pressure.
- Insufficient glycol recirculation (should be 1.5 to 3 gal TEG/lb water removed).
- Poor glycol reconcentration (exit gas dew point is 5–15 °F higher than dew point in equilibrium with lean glycol concentration).

12.13.2 High Glycol Losses

First determine where loss is occurring: from contactor (i.e., down pipeline); out of still column; or leaking from pump.

- Loss from contactor
- Inlet separator passing liquids.
- Carryover due to excessive foaming.
- Mist extractor plugged or missing.
- Lean glycol entering contactor too hot.
- Plugged trays in contactor.
- Excessive gas velocity in contactor.
- Tray spacing less than 24 in.
- Mist pad too close to top tray.
- Loss from separator
- Glycol dumped with hydrocarbons
- Loss from still
- Excessive stripping gas.
- Flash separator passing condensate.
- Packing in still column is broken, dirty, plugged.
- Insufficient reflux cooling at top of still.
- Too much cooling at top of still.
- Temperature at top of still is too high.
- Leaks, spills, etc.
- Check piping, fittings, valves, gaskets.
- Check pumps, especially packings.
- Pilferage.

Many manufacturers will estimate maximum glycol losses to be 1 lb or 1 gas per Mmsc. Improper operation can increase the actual glycol losses to 1, 10 or even 100 gallons per MMscf. One leaking pump can waste 35 gallons per day.

12.13.3 Glycol Contamination

- Carryover of oils (e.g., compressor lube oils), brine, corrosion inhibitors, well treating chemicals, sand, corrosion scales, etc from inlet separator.
- Oxygen leaks into glycol storage tanks, etc.
- Inadequate pH control (low pH) increases corrosion.
- Overheating of glycol in reboiler due to excessive temperature or hot spots on firetube.
- Improper filtration; plugged filters; bypassing of filters.
- Improper cleaning of glycol unit; use of soaps or acids.

12.13.4 Poor Glycol Reconcentration

- Low reboiler temperature.
- Insufficient stripping gas.
- Rich glycol is leaking into lean glycol in the glycol heat exchanger or in the glycol pump.
- Overloading capacity of reboiler.
- Low fuel rate or low Btu content of fuel.
- Glycol foaming in still column.
- Dirty and/or broken packing in still column.
- Flooding of still column.
- High still pressure.

12.13.5 Low Glycol Circulation – Glycol Pump

- Check pump operation. If it is a glycol powered pump, close lean glycol discharge valve; if pump continues running, it needs repair. If gas or electric, check circulation by stopping glycol discharge from contactor and timing fill rate of gauge column on chimney tray section.
- Check pump valves to see if worn or broken.
- Plugged strainer, lines, filters.
- Vapor lock in lines or pump.
- Low level in accumulator.
- Excessive packing gland leakage.
- Contactor pressure too high.

12.13.6 High Pressure Drop Across Contactor

- Excessive gas flow rate.
- Operating at pressures far below design.
- Plugged trays.
- Plugged demister pads.
- Glycol foaming.

12.13.7 High Stripping Still Temperature

- Inadequate reflux.
- Still column flooded.
- Glycol foaming.
- Carryover of light HC in rich glycol.
- Leaking reflux coil.

12.13.8 High Reboiler Pressure

- Packing in still column is broken and/or plugged with tar, dirty, etc.
- Restricted vent line, not stopped.

- Still column is flooded by excessive boil up rates and/or excessive reflux cooling.
- Slug of liquid HC enters stripper, vaporizes on reaching reboiler, and blows liquid out of still.

12.13.9 Firetube Fouling/Hot Spots/Burn Out

1. Buildup of salt, dust, scales, etc., on firetube – check inlet separator.
2. Deposition of coke, tar formed by glycol overheating and/or hydrocarbon decomposition.
3. Liquid glycol level drops exposing firetubes. Low level shutdown.

12.13.10 High Gas Dew Points

The most obvious indication of a glycol dehydration malfunction is a high water content or dew point of the outgoing sales gas stream. In most cases, this is caused by an inadequate glycol circulation rate or by an insufficient reconcentration of the glycol. These two factors can be caused by a variety of contributing problems as:

12.13.11 Cause – Inadequate Glycol Circulation Rate

1. Glycol powered pump. Close the dry discharge valve and see if the pump continues to run; if so, the pump needs to be repaired.
2. Gas or electric driven pump. Verify adequate circulation by shutting off the glycol discharge from the absorber and timing the fill rate in the gauge glass.
3. Pump stroking but not pumping. Check the valves to see if they are seating properly.
4. Check pump suction strainer for stoppage.
5. Open bleeder valve to eliminate “air lock”.
6. Be sure surge level is sufficiently high.

12.13.12 Low Reboiler Temperature

- Inadequate size firetube and/or burner.
- Setting temperature controller too low.
- More water in inlet gas because pressure is low or temperature high.
- Temperature controller not operating correctly.
- Carryover of water from inlet separator.
- Inaccurate reboiler thermometer.

12.13.13 Flash Separator Failure

- Check level controllers.
- Check dump valves.
- Excessive circulation.

12.13.14 Cause – Insufficient Reconcentration of Glycol

1. Verify the reboiler temperature with a test thermometer and be sure the temperature is in the recommended range of 350°F to 400°F for triethylene glycol. The temperature can be raised closer to 400°F, if needed, to remove more water from the glycol.
2. Check the glycol to glycol heat exchanger in the accumulator for leakage of wet, rich glycol into the dry, lean glycol.
3. Check the stripping gas, if applicable, to be sure there is a positive flow of gas. Be sure steam is not back flowing into the accumulator from the reboiler.

12.13.15 Cause – Operating Conditions Different from Design

1. Increase the absorber pressure, if needed. This may require the installation of a back pressure valve.
2. Reduce the gas temperature, if possible.
3. Increase the glycol circulation rate, if possible.

12.13.16 Cause – Low Gas Flow Rates

1. If the absorber has access man-ways, blank off a portion of the bubble caps or valve trays.
2. Add external cooling to the lean glycol and balance the glycol circulation rate for the low gas rate.
3. Change to a smaller absorber designed for the lower rate, if needed.

12.13.17 High Glycol Loss**Cause – Foaming**

Foaming is usually caused by contamination of glycol with salt, hydrocarbons, and dust, mud and corrosion inhibitors. Remove the source of contamination with

effective gas cleaning ahead of the absorber, improved solids filtration, and carbon purification.

Cause – Excessive Velocity in the Absorber

1. Decrease the gas rate.
2. Increase the pressure on the absorber, if possible.

Cause – Trays Plugged With Mud, Sludge, and Other Contaminants

If the pressure drop across the absorber exceeds about 15 psi, the trays may be dirty and/or plugged. Plugged trays and/or downcomers usually prevent the easy flow of gas and glycol through the absorber. If the absorber has access handholes, manual cleaning can be helpful. Chemical cleaning is recommended if handholes are not available.

12.14 Cause – Loss of Glycol Out of Still Column

1. Be sure the stripping gas valve is open and the accumulator is vented to the atmosphere.
2. Be sure the reboiler is not overloaded with free water entering with the gas stream.
3. Be sure excessive hydrocarbons are kept out of the reboiler.
4. Replace the tower packings in the still column, if fouled or powdered.

If the outlet gas temperature from the absorber exceeds the inlet gas temperature more than 20 to 30°F, the lean glycol entering the top of the absorber may be too hot. This could indicate a heat exchanger problem or an excessive glycol circulation rate.

If a glycol pump has been operating in a clean system, no major service will probably be needed for several years. Only a yearly replacement of packing is usually required. Normally the pump will not stop pumping unless some internal part has been bent, worn, or broken, a foreign object has fouled the pump, or the system has lost its glycol. A pump which has been running without glycol for some time should be checked before returning to normal service. The pump will probably need at least new “O” rings. The cylinders and piston rods may also have been scored from the “dry run”.

The following are typical symptoms and causes for a Kimray pump operation.

Symptoms

1. The pump will not operate.
2. The pump will start and run until the glycol returns from the absorber. The pump then stops or slows appreciably and will not run at its rated speed.
3. The pump operates until the system temperature is normal and then the pump speeds up and cavitates.
4. The pump lopes or pumps on one side only.
5. Pump stops and leaks excessive gas from the wet glycol discharge.
6. Erratic pump speed. Pump changes speed every few minutes.
7. Broken pilot piston.

Causes

1. One or more of the flow lines to the pump are completely blocked or the system pressure is too low for standard pumps.
2. The wet glycol discharge line to the reboiler is restricted. A pressure gauge installed on the line will show the restriction immediately.
3. The suction line is too small and an increase in temperature and pumping rate cavitates the pump.
4. A leaky check valve, a foreign object lodged under a check valve, or a leaky piston.
5. Look for metal chips or shavings under the pump D-slides.
6. Traps in the wet glycol power piping send alternate slugs of glycol and gas to the pump.
7. Insufficient glycol to the Main Piston D-slide ports. Elevate the control valve end of the pump to correct.

The glycol pH should be controlled to avoid equipment corrosion. Some possible causes for a low, acidic pH are:

1. Thermal decomposition, caused by an excessive reboiler temperature (over 404°F), deposits on the firetube, or a poor reboiler design.
2. Glycol oxidation, caused by getting oxygen into the glycol with the incoming gas; it can be

sucked in through a leaking pump or through unblanketed glycol storage tanks.

3. Acid gas pickup from the incoming gas stream.

Salt accumulations and other deposits on the firetube can sometimes be detected by smelling the vapors from the still vent. A “burned” odor emitted from these vapors usually indicates this type of thermal degradation. Another detection method is to observe the glycol color. It will darken quickly if the glycol degrades. These detection methods may prevent a firetube failure.

In general, maintenance and production records together with the used lean and rich glycol analyses can be very useful to the troubleshooter. A history of filter element, carbon, tower packing, and firetube change outs can be shown and the frequency of pump repairs and chemical cleaning jobs most helpful to the troubleshooter who can quickly eliminate and thus prevent costly problems.

12.15 The ADIP Process

The Shell ADIP process alkyl alkanolamines such as diisopropanolamine (DIPA), methyl diethanolamine (MDEA) or mixture of two or more solvents are used for acid gas removal. The ADIP process is suitable for the removal of H₂S from natural gas and CO₂, synthesis gas and refinery gas streams; selective removal of H₂S from gases containing H₂S, removal of H₂S and COS from light hydrocarbon streams (LPG and NGL).

ADIP – X process is a regenerable amine process for acid gas removal by using a mixture of two or more alkanolamines, in general a base amine such as MDEA and an accelerator.

12.16 Sour Water Stripping Process

Sour water streams containing hydrogen sulfide (H₂S), other organic sulfur compounds, ammonia (NH₃), and are collected from various refinery process units and are combined in a feed surge tank. Liquid hydrocarbons are decanted from the water and returned to the recovery oil tank. The Sour Water Stripper (SWS) removes hydrogen sulfide and ammonia (H₂S/NH₃) from the sour water using a stripper tower having a steam heated reboiler.

A sour water stripper either uses a steam fired reboiler as a heat source or direct application of steam (usually low quality and low pressure). There are no fired heaters associated with the sour water stripper.

The purpose of this unit is to drive as much H₂S and NH₃ overhead in the stripper as possible. The sizing of the unit is essential since its capacity must equal or exceed the normal production rates of sour water from various sources in the refinery. Generally, refiners find their strippers undersized because of a lack of provision of handling large amounts of sour water, which can result from upset conditions (e.g., start-up and shut down). There is often a large quantity of sour water waiting to be processed in the stripper, and the light of increasing importance of environmental restrictions and regulations by governments (e.g., OSHA, EPA and HSE), the sour water stripper unit plays an important role in mitigating the overall pollution of refiners.

Figure 12.29 shows the process flow diagram where the feed sour water is preheated by exchange with the stripper bottoms stream. The reboiler is heated with low pressure steam to generate a vapor stream flowing up the stripper column. Vaporization of water strips H₂S and NH₃ from the down coming sour water. Overheads vapors are cooled by an overhead condenser. The condensed water reflux is returned to the top tray in the stripper tower. The overhead, non-condensable materials, primarily H₂S and NH₃ are routed to the sulfur recovery unit as feed. The stripped water is reused at the crude desalters and at process units requiring wash water (e.g., for ammonia removal). Any remaining stripped water is routed to the wash water treatment plant. Figure 12.30 shows a photograph of Adip regenerator and Sour Water Stripper.

A Case Study

80,000 gal/day of sour water at 100 °F and 40.0 psia goes through a feed/effluent exchanger where it recovers heat from the tower bottoms stream (stripper bottoms). The

new stream (stripper feed) at 200 °F enters on tray 2 of an 8-stage distillation column with a reboiler and a total reflux condenser. A quality specification of 10 ppm wt. ammonia on the tower bottoms (stripper bottoms) is specified. The tower bottoms (stripper bottoms) exchange heat with the incoming feed and exits as effluent.

The sour water feed compositions are:

Component	Mass fraction
Hydrogen sulfide (H ₂ S)	0.007
Ammonia (NH ₃)	0.005
Water (H ₂ O)	0.988

Solution

UniSim simulation software Sour-Water-Unit.usc design R 443 is used to simulate the sour water at



Figure 12.30 Adip Regenerators and Sour Water Strippers. (Courtesy of Honeywell UniSim Design R443, all rights reserved), Honeywell (R) and UniSim (R) are registered trademarks of Honeywell International Inc.

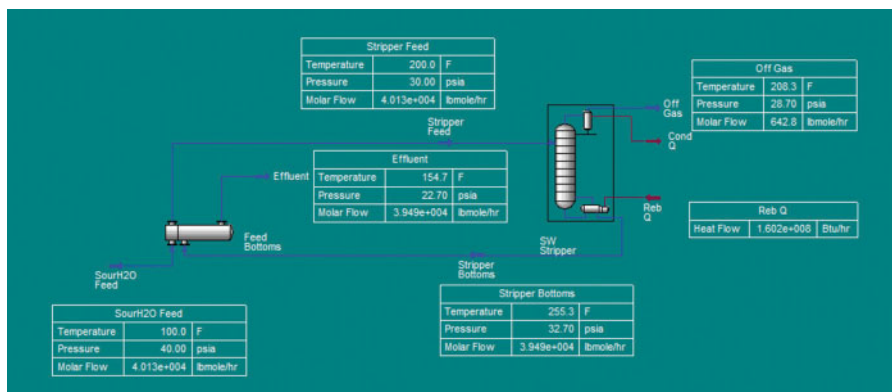


Figure 12.29 Process flow diagram of a sour water stripping unit. (Courtesy of Honeywell Process Solution, UniSim Design R443, Honeywell (R) and UniSim (R) are registered trademarks of Honeywell International, Inc.)

100°F and 40.0 psia entering the tube side of the heat exchanger with stripper bottoms entering the shell side of the exchanger. The stripper feed stream exits the outlet of tube side and enters the sour water stripping column at the second stage of an 8-plate distillation column, which is used to strip the sour components from the feed stream. The liquid leaving the bottom of the column heats the incoming feed stream in the heat exchanger.

There are two basic steps in setting up the simulation process:

1. Setup. This case study uses the Sour Peng-Robinson package and the following components: H₂S, NH₃ and H₂O.
2. Steady State Simulation. The case consists of an 8-stage stripper, used to separate H₂S and NH₃ and a heat exchanger to minimize heat loss.

The specifications are as follows:

Feed Stream

Specify the feed stream as shown

In this cell	Enter
Temperature	100°F
Pressure	40 psia
Std Ideal Liq Vol Flow	80,000 barrel/day
Comp. Mass Frac (H ₂ S)	0.0070
Comp. Mass Frac. (NH ₃)	0.0050
Comp. Mass Frac. (H ₂ O)	0.9880

Operations:

1. Install and specify the heat exchanger as:

Tab [Page]	In this cell	Enter
Design [Connections]	Tube Side Inlet	Sour H ₂ O Feed
	Tube Side Outlet	Stripper Feed
	Shell Side Inlet	Stripper Bottoms
	Shell Side Outlet	Effluent
	Heat Exchanger Model	Exchanger Design (Weighted)
Design [Parameters]	Tube Side Delta P	10 psi
	Shell Side Delta P	10 psi
	Temperature (stripper Feed)	200°F
Worksheet [Conditions]		

2. Install a distillation column. The column will have both a reboiler and an overhead condenser.
3. Define the column configuration as shown below.

	In this cell	Enter
Connections	No. of stages	8
	Inlet Stream	Stripper Feed
	Inlet stage	2
	Condenser Type	Full Reflux
	Ohd Vapor	Off Gas
	Bottoms Liquid	Stripper Bottoms
	Reboiler Energy Stream	Q-Reb
	Condenser Energy Stream	Q-Cond
Pressure Profile	Condenser Pressure	28.7 psia
	Reboiler Pressure	32.7 psia

4. In the column property view, click the **Design** tab, then select the **Monitor** page.

In the present configuration, the column has two degrees of freedom; the two specifications used will be a quality specification and a reflux ratio.

5. Modify the existing specification as shown below

Column [SW Stripper]		
Tab [Page]	Variable Spec	Modify
Design [Specs]	Ovhd Vap Rate	Active = uncheck
	Reflux Ratio	Active = checked Spec Value = 10 Molar

6. Add a Component Fraction specification, and enter the following information in the Comp Frac Spec view

Tab	In this cell	Enter
Parameters	Name	NH ₃ Mass Frac. (Reboiler)
	Stage	Reboiler
	Spec Value	0.000010
	Component	Ammonia
	Summary	Active
	Reflux Ratio Spec Value	Active 10 Molar

7. Click the Parameters tab, and then select the Solver page. Change the Fixed Damping Factor to 0.4.

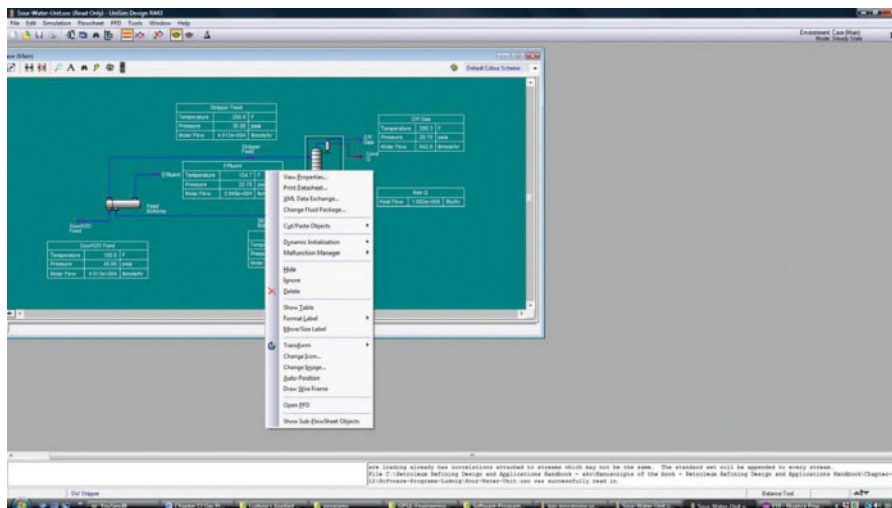


Figure 12.31 Snapshot of printing the results of the Sour Water Stripping unit, (Courtesy of Honeywell Process Solution, UniSim Design R443, Honeywell (R) and UniSim (R) are registered trademarks of Honeywell International Inc.)

A damping factor will speed up tower convergence and reduce the effects of any oscillations in the calculations (the default value is 1.0).

- Run the column to calculate the values by clicking the **Run** button.

The results of the converged simulation are shown in Sour-Water-Unit.usc, by right-clicking the SW Stripper icon from the snapshot of Figure 12.31. Then click on print **Datasheet**.

References

- Avinash Gupta, Chevron Lummus Global Ebullated bed Bottom of the Barrel Hydroconversion (LC- Fining) Process, Chapter 8.7, p. 8.67, in *Handbook of Petroleum Refining Processes*, ed. Meyers, R. A., 3rd ed., McGraw-Hill, 2004.
- Gowdy, H. W., UOP Unisar Process for Saturation of Aromatics, Chapter 8.6, p. 8.59, in *Handbook of Petroleum Refining Processes*, ed. Meyers, R. A., 3rd ed., McGraw-Hill, 2004.
- Gillis, Daniel, B., UOP RCD Unionfining Process, Chapter 8.4, p. 8.43, in *Handbook of Petroleum Refining Processes*, ed. Meyers, R. A., 3rd ed., McGraw-Hill, 2004.
- Kokayeff, P., UOP Unionfining Technology. Chapter 8.3, p 8.31 in *Handbook of Petroleum Refining Processes*, ed. Meyers, R. A., 3rd ed., McGraw-Hill, 2004.
- Dziabis, G. A., UOP Merox Process. *Handbook of Petroleum Refining Processes*, pp 11.31, ed. Meyers, R. A., 3rd ed, McGraw-Hill, 2003.
- Maddox, R. N., "Gas and Liquid Sweetening", Campbell Petroleum Series, 1997.
- Engineering Data Book*, Gas Processing Suppliers Association, Vol. 2, 12th ed., Section 19, Tulsa, OK, 2004.
- Blackwell, W. W., "Chemical Process Design on A Programmable Calculator", McGraw-Hill, New York, 1984.
- Wunder, J. W., "How to Design a Natural Gas Drier", *Oil & Gas Journ.* August 6, pp 137–148, 1962.
- Bryant, P. A., from A. K. Coker "Chapter 11 of Ludwig's *Applied Process Design for Chemical and Petrochemical Plants*, Vol. 2, 4th ed., Gulf Professional Publishing, 2010.
- Edmister, W. C., "Design of Hydrocarbon Absorption and Stripping", *Ind. Eng. Chem.*, V. 35, p 837, 1943.
- Edmister, W. C., "Hydrocarbon Absorption and Fractionation Process Design Methods", *Pet. Engr.* May 1947 – March, 1949 and "Absorption and Stripping-Factor Functions for Distillation Calculations by Manual and Digital – Computer Methods", *AIChE, Journal*, V. 3, No. 2, p 165, 1957.
- Horton, G. W., and B. Franklin, "Calculation of Absorber Performance and Design", *Ind. Eng. Chem.*, V. 32, p. 1384, 1940.
- Kremser, A. "Theoretical Analysis of Absorption Process", *Nat. Pet., News*, V. 22, p. 48, 1930.
- Sherwood, T. K., *Absorption and Extraction*, McGraw-Hill, New York, 1937.
- Souders, M., Jr., G. G. Brown, "Fundamental Design of Absorbing and Stripping Columns, for Complex Vapors", *Ind. Eng. Chem.*, V. 24, p. 519, 1932.
- Maddox, R. N., "Absorber Performance", *Oil & Gas Journ.*, p. 146, May 25, 1964.
- Branan, C., *Rules of Thumb for Chemical Engineers*, 4th ed., Gulf Publishing, 2005.

19. Hull, R. J., and K. Raymond, "How To Design and Evaluate Absorbers", *Oil & Gas Jour.* No. 9, 1953 through Mar. 15, 1954.
20. Hutchinson, A. J. L., "A System of Calculations for Light Hydrocarbons", *Pet. Ref.*, Oct. 1950 – April 1951.
21. O'Connell, H. E., "Plate Efficiency of Fractionating Columns and Absorbers", *Trans. AIChE.*, Vol. 42, p. 741, 1946.
22. Francis, S., Manning and E. Richard, *Thompson's Oilfield Processing of Petroleum*, Volume One: *Natural Gas*, PennWell Books, 1991.
23. Ballard, Don, "How to Improve Glycol Dehydration", Coastal Chemical Co., Inc., 1979.
24. Tennyson, R. N., and R. P. Scharp, "Guidelines Can Help Choose Proper Process For Gas Treating Plants", *Oil & Gas Journ.*, January 10, 1977.
25. Goel, S. K., Khanna, S., and D. K. Zutshi, Sulfur Management in Refineries, *Chemical Engineering Digest*, p. 81, May 2008.
26. Indra Deo Mall, *Petroleum Refining Technology*, CBS Publishers & Distributors, Pvt Ltd., 2015.
27. Legrand, C. and J. Castel, "Acid gas treatment", In "Conversion Processes", *Petroleum Refining*, vol. 3, Leprince. P., ed. TECHNIP, France, 2001.

Glossary of Petroleum and Technical Terminology

Abatement: 1. The act or process of reducing the intensity of pollution. 2. The use of some method of abating pollution. 3. Putting an end to an undesirable or unlawful condition affecting the wastewater collection system.

Abrasion (Mechanical): Wearing away by friction.

Abrasive: Particles propelled at a velocity sufficient to cause cleaning or wearing away of a surface.

Absolute Porosity: The percentage of the total bulk volume, which is pore spaces, voids or fractures.

Absolute Pressure: 1. The reading of gauge pressure plus the atmospheric pressure. 2. Gauge pressure plus barometric or atmospheric pressure. Absolute pressure can be zero in a perfect vacuum. Units, psia, bara. e.g., psia = psig + 14.7, bara = barg + 1.013.

Absolute Temperature: Temperature measurement starting at absolute zero. e.g., °R = °F + 460, K = °C + 273.16

Absolute Viscosity: The measure of a fluid's ability to resist flow without regard to its density. It is defined as a fluid's kinematic viscosity multiplied by its density.

Absorbent: The material that can selectively remove a target constituent from another compound by dissolving it.

Absorption: A variation of fractionation. In a distillation column, the stream to be separated is introduced in vapor form near the bottom. An absorption liquid called lean oil is introduced at the top. The lean oil properties are such that as the two pass each other, the lean oil will selectively absorb components of the stream to be separated and exit the bottom of the fractionator as rich oil. The rich oil is then easily separated into the extra and lean oil in conventional fractionation.

Absorption Gasoline: Gasoline extracted from wet natural gas by putting the gas in contact with oil.

Absorption Oil (Facilities): The wash oil used to remove heavier hydrocarbons from the gas stream.

Accident: An event or sequence of events or occurrences, natural or man-made that results in undesirable consequences and requires an emergency response to protect life and property.

Accumulator: A vessel that receives and temporarily stores a liquid used in the feedstock or the processing of a feed stream in a gas plant or other processing facility.

Acentric Factor: A correlating factor that gives a measure of the deviation in behavior of a substance to that for an idealized simple fluid. It is a constant for each component and has been correlated with the component vapor pressure.

Acid Gas: 1. A gas that contains compounds such as CO_2 , H_2S or mercaptans (RSH , where $\text{R} = \text{C}_n\text{H}_{2n+1}$, $n=1, 2$) that can form an acid in solution with water. 2. Group of gases that are found in raw natural gas and are usually considered pollutants. Amongst these are CO_2 , H_2S and mercaptans. 3. Any produced gas primarily H_2S and CO_2 that forms an acid when produced in water.

Acid Inhibitor: Acid corrosion inhibitor. It slows the acid attack on metal.

Acid Number: A measure of the amount of potassium hydroxide (KOH) needed to neutralize all or part of the acidity of a petroleum product. Also referred to as neutralization number (NN) or value (NV) and total acid number (TAN).

Acid Soluble Oil (ASO): 1. High boiling polymers produced as an unwanted by-product in the alkylation processes. 2. Polymers produced from side reactions in the alkylation process.

Acid Treating/Treatment: A process in which unfinished petroleum products, such as gasoline, naphthas, kerosene, diesel fuel, and lubricating oil stocks, are contacted with sulfuric acid to improve their color, odor, and other properties.

Acidity: The capacity of water or wastewater to neutralize bases. Acidity is expressed in milligrams per liter of equivalent calcium carbonate (CaCO_3). Acidity is not the same as pH because water does not have to be strongly acidic (low pH) to have a high acidity. Acidity is a measure of how much base must be added to a liquid to raise the pH to 8.2.

AC Motor: Most of the pumps are driven by alternating current, three-phase motors. Such motors that drive pumps are usually fixed-speed drivers. DC motors are rarely used in process plants.

Activity of Catalyst: Activity generally means how well a catalyst performs with respect to reaction rate, temperature or space velocity.

Actual Tray: A physical tray (contact device) in a distillation column, sometimes called a plate.

Adsorbents: Special materials like activated charcoal, alumina or silica gel, used in an adsorption process that selectively cause some compounds, but not others, to attach themselves mechanically as liquids.

Adsorption: 1. A process for removing target constituents from a stream by having them condense on an adsorbent, which is then taken off line so the target constituents can be recovered. 2. The process by which gaseous components adhere to solids because of their molecular attraction to the solid surface.

Alarms: Process parameters (levels, temperatures, pressures, flows) are automatically controlled within a permissible range. If the parameter moves outside this range, it sometimes activates both an audible and a visual alarm. If the panel board operator fails to take corrective action, a trip may also then be activated.

Alcohol: The family name of a group of organic chemical compounds composed of carbon, hydrogen and oxygen. The series of molecules vary in chain length and are composed of a hydrocarbon plus a hydroxyl group, $\text{CH}_3(\text{CH}_2)_n - \text{OH}$ (e.g., methanol, ethanol, tertiary butyl alcohol).

Alkanolamine: An organic nitrogen bearing compound related to ammonia having at least one, two or three of its hydrogen atoms substituted with at least one, two or three linear or branched alkanol groups where only one or two could also be substituted with a linear or branched alkyl group (i.e., methyldiethanolamine MDEA). The number of hydrogen atoms substituted by alkanol or alkyl groups at the amino site determines whether the alkanolamine is primary, secondary or tertiary.

Alkylate: 1. The gasoline produced by an alkylation process. It is made by combining the low boiling hydrocarbons catalytically to obtain a mixture of high-octane hydrocarbons boiling in the gasoline range. 2. The product of an alkylation reaction. It usually refers to the high octane product from alkylation units. This alkylate is used in blending high octane gasoline.

Alkylate Bottoms: A thick, dark brown oil containing high molecular-weight polymerization products of alkylation reactions.

Alkylation: 1. A refining process for chemically combining isobutane (iC_4H_{10}) with olefin hydrocarbons [e.g., propylene (C_3H_6), butylenes (C_4H_8)] through the

control of temperature and pressure in the presence of an acid catalyst. 2. A refining process in which light olefins primarily a mixture of propylene (C_3H_6), butylenes (C_4H_8) and/or amylenes are combined with isobutane (iC_4H_{10}) over an acid catalyst to produce a high octane gasoline (highly branched $C_5 - C_{12}$, i-paraffins), called alkylate. The commonly used catalysts are sulfuric acid (H_2SO_4) and hydrofluoric acid (HF). The major constituents of alkylate are isopentane and isooctane (2,2,4-trimethyl pentane, TMP), the latter possessing an octane number of 100. The product, alkylate, is an isoparaffin, has high octane value and is blended with motor and aviation gasoline to improve the antiknock value of the fuel.

Aluminum Chloride Treating: A quality improvement process for steam cracked naphthas using aluminum chloride ($AlCl_3$) as a catalyst. The process improves the color and odor of the naphtha by the polymerization of undesirable olefins into resins. The process is also used when production of resins is desirable.

American Petroleum Institute (API): An association, which among many things sets technical standards for measuring, testing and other types of handling of petroleum.

Amine Treating: Contacting of a gas or light hydrocarbon liquid with an aqueous solution of an amine compound to remove the hydrogen sulfide (H_2S) and carbon dioxide (CO_2).

Anaerobic Digestion: Is a collection of processes by which microorganisms break down biodegradable material in the absence of oxygen. The process is used for industrial or domestic purposes to manage waste and/or to produce fuels. Much of the fermentation used industrially to produce food and drink products, as well as home fermentation uses anaerobic digestion.

The digestion process begins with bacterial hydrolysis of the input materials. Insoluble organic polymers such as carbohydrates are broken down to soluble derivatives that become available for other bacteria. It is used as part of the process to treat biodegradable waste and sewage sludge. As part of an integrated waste management system, anaerobic digestion reduces the emission of landfill gas into the atmosphere. Anaerobic digestion is widely used as a source of renewable energy. The process produces biogas, consisting of methane, carbon dioxide and traces of other "contaminant" gases. The biogas can

be used directly as fuel in combined heat and power gas engines or upgraded to natural gas-quality biomethane. The nutrient-rich digestate also produced can be used as fertilizer.

Aniline Point: The minimum temperature for complete miscibility of equal volumes of aniline and the test sample. The test is considered an indication of the paraffinicity of the sample. The aniline point is used as a classification of the ignition quality of diesel fuels.

Antiknock Agent: 1. Is a gasoline additive used to reduce engine knocking and increase the fuel's octane rating by raising the temperature and pressure at which auto-ignition occurs. The mixture is gasoline or petrol, when used in high compression internal combustion engines, has a tendency to knock (also, referred to as pinging, or pinking) and/or to ignite early before the correctly time spark occurs (pre-ignition, refers to engine knocking). 2. The most wanted and widely used additives in gasoline are the antiknock compounds. They assist to enhance the octane number of gasoline. Lead in the form of tetra ethyl lead (TEL) or tetra methyl lead (TML) is a good antiknock compound. TEL helps to increase the octane number of gasoline without affecting any other properties, including vapor pressure, but when used alone in gasoline gives rise to troublesome deposits.

Antiknock Index: The Research Octane Number (RON) test simulates driving under mild conditions while the Motor Octane Number (MON) test simulates driving under severe conditions, i.e., under load and at high speed. The arithmetic average of RON and MON that gives an indication of the performance of the engine under the full range of conditions is referred to as AntiKnock Index (AKI). It is determined by:

$$\text{Antiknock Index (AKI)} = \frac{\text{RON} + \text{MON}}{2}$$

Antiknock Quality (Octane Number): Knocking is a characteristic property of motor fuels that governs engine performance and is expressed in terms of octane number. It depends on the properties of hydrocarbon type and nature. Octane number is the percentage of iso-octane in the reference fuel, which matches the knocking tendency of the fuel under test. Research octane number (RON) and motor octane number

(MON) are two methods used and are measured with a standard single cylinder, variable compression ratio engine. For both octane numbers, same engine is used, but operated at different conditions. The distinction between two octane numbers (RON and MON) measurement procedures are engine speed, temperature of admission and spark advance. The motor method captures the gasoline at high engine speeds and loads, and the research octane method at low speed depending on the fuel characteristics. The MON is normally 8–10 points lower than the RON. A high tendency to auto-ignite, or low octane rating, is undesirable in a gasoline engine, but desirable in a diesel engine.

$$\text{Antiknock index (AKI)} = (\text{RON} + \text{MON})/2.$$

API Gravity: A method for reporting the density of petroleum streams. It is defined as

$$^{\circ}\text{API} = \left[\frac{141.5}{\text{Sp.Gr @ } 60/60^{\circ}\text{F}} - 131.5 \right], \text{ where Sp.Gr}$$

is the specific gravity relative to water. $^{\circ}\text{API}$ gravity is reported at a reference temperature of 60°F (15.9°C).

The scale allows representation of the gravity of oils, which on the specific gravity $60/60^{\circ}\text{F}$ scale varies only over a range of 0.776 by a scale that ranges from less than 0 (heavy residual oil) to 340 (methane).

According to the expression, 10°API indicates a specific gravity of 1 (equivalent to water specific gravity). Thus, higher values of API gravity indicate lower specific gravity and therefore lighter crude oils, or refinery products and vice-versa. As far as crude oil is concerned lighter API gravity value is desired as more amount of gas fraction, naphtha and gas oils can be produced from the lighter crude oil than with the heavier crude oil. Therefore, crude oil with high values of API gravity is expensive to produce due to their quality.

Classification of crude oils

Crude category	$^{\circ}\text{API}$ gravity
Light crudes	$^{\circ}\text{API} > 38$
Medium crudes	$38 > ^{\circ}\text{API} > 29$
Heavy crudes	$29 > ^{\circ}\text{API} > 8.5$
Very heavy crudes	$^{\circ}\text{API} < 8.5$

The higher the API gravity, the lighter the compound. Light crudes generally exceed 38°API and

heavy crudes are commonly are crudes with an $^{\circ}\text{API}$ of 22 or below. Intermediate crudes fall in the range of $22\text{--}38^{\circ}\text{API}$ (See Figures 1a and 1b).

Aromatics: 1. A group of hydrocarbons characterized by having at least one benzene ring type structure of six carbon atoms with three double and three single bonds connecting them somewhere in the molecule. The general formula is $\text{C}_n\text{H}_{2n-6}$ where $n = 6, 7, 8$, etc. The simplest is benzene, plus toluene and the xylenes. Aromatics in gas oils and residues can have many, even scores of rings. 2. The three aromatic compounds – benzene (C_6H_6), toluene (C_7H_8), xylene (C_8H_{10}).

As Low As Reasonably Practicable (ALARP): The principle that no industrial activity is entirely free from risk and that it is never possible to be sure that every eventuality has been covered by safety precautions, but that there would be a gross disproportion between the cost in (money, time or trouble) of additional preventive or protective measures, and the reduction in risk in order to achieve such low risks (See Figure 2).

Asphalt: 1. A heavy semi-solid petroleum product that gradually softens when heated and is used for surface cementing. Typically brown or black in color, it is composed of high carbon to hydrogen hydrocarbons. It occurs naturally in crude oil or can be distilled or extracted. 2. The end product used for area surfacing consisting of refinery asphalt mixed with aggregation. 3. Heavy tar-like residue from distillation of some types of crude oil. Asphalt components are high molecular weight derivatives of aromatic compounds. Not all asphalt materials are suitable for use as building agents in road pavement.

Asphaltenes: Highly condensed masses of high molecular weight aromatic compounds. They exit in petroleum residuum as the center of colloidal particles or micelles. The asphaltenes are kept in solution by an outer ring of aromatic compounds of lower molecular weight. They can precipitate when the continuous nature of the surrounding ring of aromatics is broken down by cracking processes.

Assay Data: Laboratory test data for a petroleum stream, including laboratory distillation, gravity, compositional breakdown and other laboratory tests. Numerous important feed and product characterization properties in refinery engineering include:

- | | |
|-----|--|
| 1. | API gravity |
| 2. | Watson Characterization factor |
| 3. | Viscosity |
| 4. | Sulfur content, wt % |
| 5. | Nitrogen content, wt % |
| 6. | Carbon residue, wt% |
| 7. | Salt content |
| 8. | Metal contents |
| 9. | Asphaltene, % |
| 10. | Naphthenes, % |
| 11. | True boiling point (TBP) curve |
| 12. | Pour point |
| 13. | Cloud point |
| 14. | Freeze point |
| 15. | Aniline point |
| 16. | Flash and fire point |
| 17. | ASTM distillation curve |
| 18. | Octane number |
| 19. | Conradson carbon |
| 21. | Reid vapor pressure |
| 22. | Bottom sediment and water (BS &W) |
| 23. | Light hydrocarbon yields ($C_1 - C_5$) |

The crude quality is getting heavier worldwide. Existing refineries that are designed to handle normal crudes are being modified to handle heavy crude. New technology for upgrading is used to obtain clean and light products from lower cost feeds. The crude assay will determine the yields of different cuts and consequently the refinery configuration.

Associated Natural Gas: Natural gas that is dissolved in crude in the reservoir and is co-produced with the crude oil.

ASTM: American Society of Testing and Materials. Nearly all of the refinery product tests have been standardized by ASTM.

ASTM Distillation: A standardized laboratory batch distillation for naphthas and middle distillates carried out at atmospheric pressure without fractionation.

ASTM Distillation Range: Several distillation tests are commonly referred to as "ASTM distillations." These are usually used in product specifications. These

ASTM distillations give results in terms of percentage distilled versus temperature for a sample laboratory distillation with no fractionation. The values do not correspond to those of refinery process distillations, where fractionation is significant.

ASTM D86 Distillation: Of an oil fraction takes place at laboratory room temperature and pressure. Note that the D86 distillation will end below an approximate temperature of 650°F (344°C), at which petroleum oils begin to crack at one atmospheric pressure.

ASTM D1160 Distillation: Of an oil fraction is applicable to high-boiling oil samples (e.g., heavy heating oil, cracker gas oil feed, residual oil, etc.) for which there is significant cracking at atmospheric pressures. The sample is distilled at a reduced pressure, typically at 10 mm Hg, to inhibit cracking. In fact, at 10 mmHg, we can distill an oil fraction up to temperatures of 950–1000°F (510–538°C), as reported on a 760 mm Hg basis. The reduced pressure used for D1160 distillation produces a separation of components that is more ideal than that for D86 distillation.

ASTM D2887 Distillation: Of oil fraction is a popular chromatographic procedure to "simulate" or predict the boiling point curve of an oil fraction. We determine the boiling point distribution by injecting the oil sample into a gas chromatograph that separates the hydrocarbons in a boiling-point order. We then relate the retention time inside the chromatograph to the boiling point through a calibration curve.

ASTM End Point of Distillates: End point is an important specification or way of describing gasolines, naphthas, or middle distillates. It's the approximate relationship between the end point of a fraction and its True Boiling Point (TBP) and other cut points.

Atmospheric Distillation: 1. The refining process of separating crude oil components at atmospheric pressure by heating to temperatures of 600–750°F (316–400°C) (depending on the nature of the crude oil and desired products) and subsequent condensing of the fractions by cooling. 2. Distillation/Fractionation of crude oil into various cuts/fractions under atmospheric condition. The more volatile components (i.e., lower boiling points) rise through trays/bubble caps and are condensed at various temperatures and the least volatile components, short and long residues

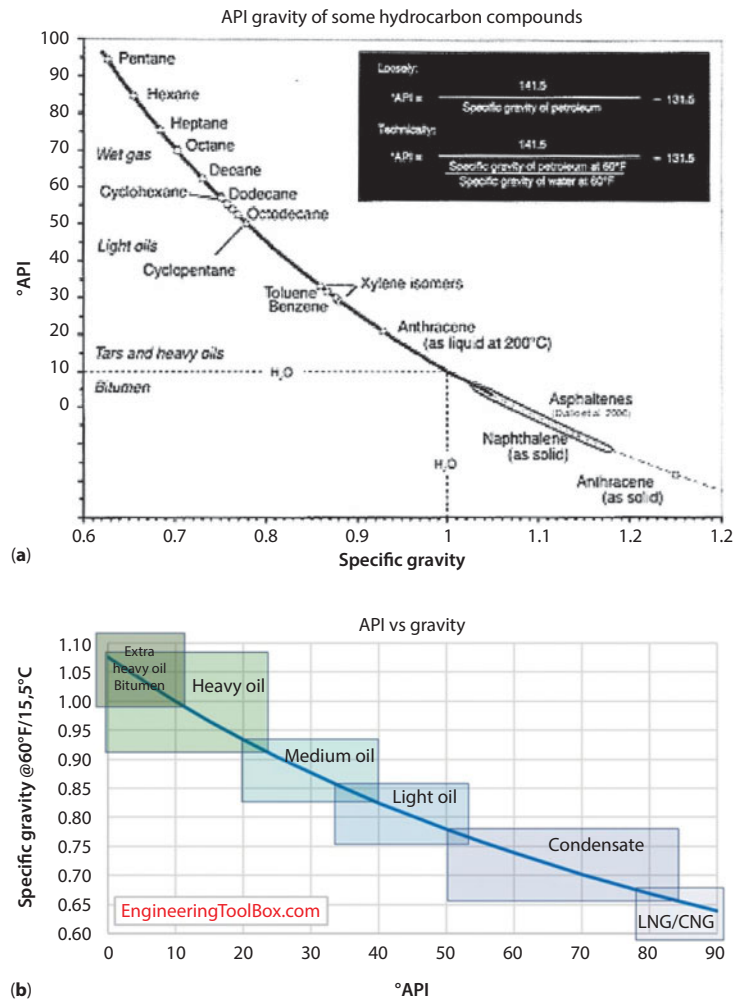


Figure 1 (a) A plot of °API vs. specific gravity of hydrocarbons compounds. (b) Specific gravity vs. °API of hydrocarbons (Source: EngineeringToolBox.com)

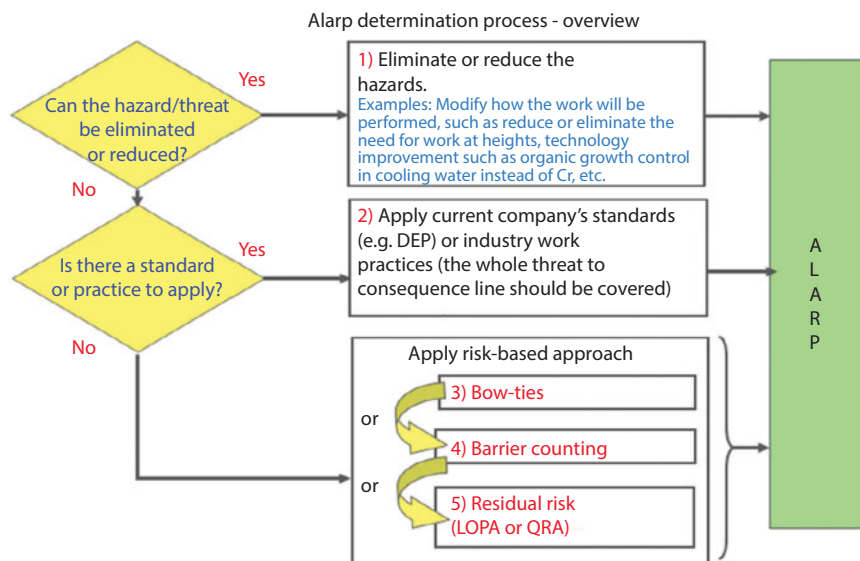


Figure 2 ALARP determination process overview. DEP = Design Engineering Practice.

(i.e., higher boiler points) are removed as bottom products.

Atmospheric Crude Oil Distillation: The refining process of separating crude oil components at atmospheric pressure by heating to temperatures of about 600–750 °F (316–400°C) (depending on the nature of the crude oil and desired products) and subsequent condensing of the fractions by cooling.

Atmospheric Gas Oil (AGO): A diesel fuel and No. 2 heating oil blending stock obtained from the crude oil as a side stream from the atmospheric distillation tower.

Atmospheric Reduced Crude (ARC): The bottoms stream from the atmospheric distillation tower.

Atmospheric Residuum: The heaviest material from the distillation of crude oil in a crude distillation column operating at a positive pressure.

Autoignition: The spontaneous ignition and resulting rapid reaction of a portion of or all the fuel-air mixture in the combustion chamber of an internal combustion engine. The flame speed is many times greater than that following normal ignition.

Autoignition Temperature (AIT): 1. The lowest temperature at which a gas will ignite after an extended time of exposure. 2. The lowest temperature at which a flammable gas or vapor air mixture will ignite from its own heat source or a contacted heat source without the necessity of a spark or a flame.

Aviation Gasoline Blending Components: Naphtha's which will be used for blending or compounding into finished aviation gasoline (e.g., straight-run gasoline, alkylate, reformat, benzene, toluene, xylenes). Excludes oxygenates (alcohols, ethers), butanes and pentanes. Oxygenates are reported as other hydrocarbons, hydrogen and oxygenates.

Aviation Gasoline (Finished): A complex mixture of relatively volatile hydrocarbons with or without small quantities of additives, blended to form a fuel suitable for use in aviation reciprocating engines. Fuel specifications are provided in ASTM Specification D910 and Military Specification MIL-G-5572. Note: Data on blending components are not counted in data on finished aviation gasoline.

Azeotrope: A constant boiling point mixture for which the vapor and liquid have identical composition.

Azeotropes cannot be separated with conventional distillation.

Backflow: 1. A flow condition, caused by differential pressure, resulting in the flow of liquid into the potable water supply system from sources other than those intended; or the backing up of liquid, through a conduit or channel, in a direction opposite to normal flow. 2. Return flow from injection of a fluid into a formation.

Back Pressure: A pressure caused by a restriction or fluid head that exerts an opposing pressure to flow.

Barrel: A volumetric measure of refinery feedstocks and products equal to 42 U.S. gal.

Barrels Per Calendar Day (BPCD or B/CD): Average flow rates based on operating 365 days per year. The amount of input that a distillation facility can process under usual operating conditions. The amount is expressed in terms of capacity during a 24-hour period and reduces the maximum process capability of all units at the facility under continuous operation to account for the following limitations that may delay, interrupt, or slow down production: The capability of downstream facilities to absorb the output of crude oil processing facilities of a given refinery. No reduction is made when a planned distribution of intermediate streams through other than downstream facilities is part of a refinery's normal operation; the types and grades of inputs to be processed; the types and grades of products expected to be manufactured; the environmental constraints associated with refinery operations; the reduction of capacity for scheduled downtime due to such conditions as routine inspection, maintenance, repairs and turnaround, and the reduction of capacity for unscheduled downtime due to such conditions.

Barrels Per Stream Day (BPSD or B/SD): The maximum number of barrels of input that a distillation facility can process within a 24-hour period when running at full capacity under optimal crude and product slate conditions with no allowance for downtime. This notation equals barrels per calendar day divided by the service factor.

Basic Process Control System (BPCS): A system which responds to input signals from the process, its associated equipment, other programmable systems and/or an operator and generates output signals causing the process and its associated equipment to operate

in the desired manner but which does not perform any safety instrumented functions (SIF) with a claimed Safety Instrumented Level, SIL ≥ 1.

Battery Limits (BL): The periphery of the area surrounding any process unit, which includes the equipment for the particular process.

Baume gravity: Specific gravity of liquids expressed as degrees on the Baume scale. For liquids lighter than water,

$$\text{Sp.Gr @15.6 / 15.6 } ^\circ\text{C} = \frac{140}{130 + \text{deg Be}}$$

For liquids heavier than water

$$\text{Sp.Gr @15.6 / 15.6 } ^\circ\text{C} = \frac{145}{145 - \text{deg Be}}$$

Bbl: Abbreviation for a quantity of 42 U.S. gal.

Benchmark crude: A reference crude oil with whom the prices of other crudes are compared with.

Benzene (C₆H₆): An aromatic hydrocarbon present in small proportion in some crude oils and made commercially from petroleum by the catalytic reforming of naphthenes in petroleum naphtha. It is also made from coal in the manufacture of coke. Used as a solvent, in manufacturing detergents, synthetic fibers, and petrochemicals and as a component of high-octane gasoline.

Bernoulli equation: A theorem in which the sum of the pressure-volume, potential, and kinetic energies of an incompressible and non-viscous fluid flowing in a pipe with steady flow with no work or heat transfer is the same anywhere within a system. When expressed in head form, the total head is the sum of the pressure, velocity and static head. It is applicable only for incompressible and non-viscous fluids as:

In SI Units

$$\frac{P_1}{\rho_g} + \frac{v_1^2}{2g} + z_1 = \frac{P_2}{\rho_g} + \frac{v_2^2}{2g} + z_2 + h_f$$

where h_f is the pipe friction from point 1 to point 2 may be referred to as the head loss in metres of fluid.

In Imperial Units.

$$\frac{144P_1}{\rho} + \frac{v_1^2}{2g_c} + z_1 \frac{g}{g_c} = \frac{144P_2}{\rho} + \frac{v_2^2}{2g_c} + z_2 \frac{g}{g_c} + h_f$$

where h_f is the pipe friction from point 1 to point 2 in foot-pounds force per pound of flowing fluid; this is sometimes referred to as the head loss in feed of fluid.

where, P is pressure, ρ is density, g_c is conversion factor $\left(32.174 \frac{\text{lb}_m}{\text{lb}_f} \cdot \frac{\text{ft}}{\text{s}^2} \right)$, g is acceleration due to gravity (32 ft/s²), v is velocity, z is elevation and h_f is frictional head loss. It is a statement of the law of the conservation of energy, which was formulated by Daniel Bernoulli in 1738 (See Figure 3).

Bitumen: That portion of petroleum, asphalt, and tar products that will dissolve completely in carbon disulfide (CS₂). This property permits a complete separation from foreign products not soluble in carbon disulfide.

Blast: A transient change in gas density, pressure (either positive or negative), and velocity of the air surrounding an explosion point.

Blending: One of the final operations in refining, in which two or more different components are mixed together to obtain the desired range of properties in the final product.

Blending Components: Modern gasoline is a blend of various refinery streams produced by distillation, cracking, reforming and polymerization together with additives to achieve the specific fuel performance requirements.

Blending Octane Number: When blended into gasoline in relatively small quantities, high-octane materials behave as though they had an octane number higher than shown by laboratory tests on the pure

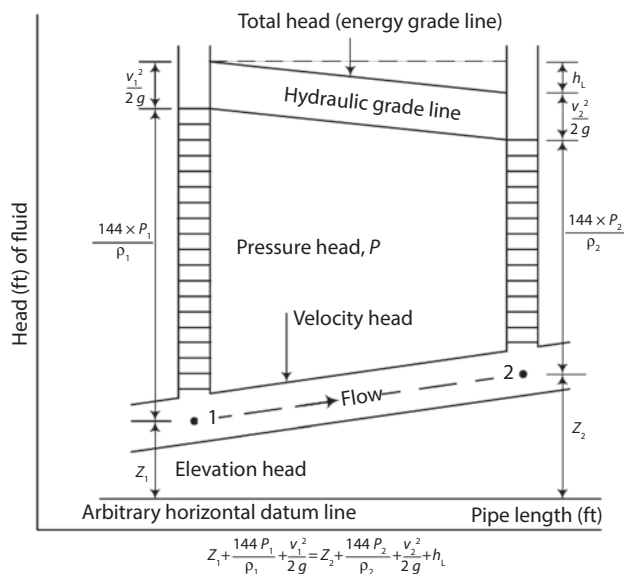


Figure 3 Distribution of fluid energy in a pipeline.

material. The effective octane number of the material in the blend is known as the blending octane number.

Blending Plant: A facility which has no refining capability but is either capable of producing finished motor gasoline through mechanical blending or blends oxygenates with motor gasoline.

Blending Value (hydrocarbon): In octane ratings of a hydrocarbon made on blends of 20 percent hydrocarbon plus 80 percent of a 60 : 40 mixture of isooctane (iC_8H_{18}) and n-heptane (nC_7H_{16}), the blending octane number is a hypothetical value obtained by extrapolation of a rating of 100% concentration of the hydrocarbon.

Blocked operation: A set of operating conditions and procedures that apply to a particular feed stock and/or set of product specifications for a process.

Boiler: 1. A closed vessel in which a liquid is heated or heated and evaporated. Boilers are often classified as steam or hot water, low pressure or high pressure, and capable of burning one fuel or a number of fuels. 2. Vessel in which a liquid is heated with or without vaporization; boiling need not occur.

Boiler Feed Pump: A pump which returns condensed steam, makeup water or both directly to the boiler.

Boiler Feed Water: Water supplied to a boiler by pumping.

Boiling Liquid Expanding Vapor Explosion (BLEVE): 1. The nearly instantaneous vaporization and corresponding release of energy of a liquid upon its sudden release from a containment under pressure than atmospheric pressure and at a temperature above its atmospheric boiling point. 2. A type of rapid phase transition in which a liquid contained above its atmospheric boiling point is rapidly depressurized, causing a nearly instantaneous transition from liquid to vapor with a corresponding energy release. A BLEVE is often accompanied by a large fireball if a flammable liquid is involved, since an external fire impinging on the vapor space of a pressure vessel is a common BLEVE scenario. However, it is not necessary for the liquid to be flammable to have a BLEVE to occur.

Blowdown: The disposal of voluntary discharges of liquids or condensable vapors from process and vessel drain valves, thermal relief or pressure relief valves.

Blowout: An uncontrolled flow of gas, oil or other well fluids from a wellbore at the wellhead or into a

ground formation, caused by the formation pressure exceeding the drilling fluid pressure. It usually occurs during drilling on unknown (exploratory) reservoirs.

Boiling Point: 1. Heat a liquid and its vapor pressure increases. When the liquid's vapor pressure equals the pressure in the vessel, the liquid starts to boil. The temperature at which this boiling starts is the liquid's boiling temperature. 2. Typically refers to the temperature at which a component or mixture of components starts to vaporize at a given pressure. When used in petroleum refining, it is usually synonymous with the normal boiling point (i.e., boiling point at one atmosphere). 3. The temperature at which the pressure exerted by molecules leaving a liquid equals the pressure exerted by the molecules in the air above it. A free-for-all of molecules leaving the liquid then ensues. In a solution, the boiling point will be increased by a number that depends on the number of particles in solution:

$$\Delta(T) = K_b \times (\text{number of solute molecules per liter})$$

where

$\Delta(T)$ = the rise in the boiling point.

K_b = the ebullioscopic constant and varies from one solvent to another.

Boiling Range: 1. The spread of temperatures over which oil starts to boil or distill vapors and proceeds to complete evaporation. Boiling range is determined by ASTM test procedures for specific petroleum products. It is measured in °F or (°C). 2. The lowest through to highest boiling temperatures for a petroleum stream when distilled. Boiling ranges are often reported on a TBP (true boiling point) basis, i.e., as normal boiling points.

Boiling Temperature: The temperature at which steam bubbles begin to appear within a liquid. When the fluid is a pure compound, the boiling point is unique for each pressure.

Boil Off: A small amount of LNG evaporates from the tank during storage, cooling the tank and keeping the pressure inside the tank constant and the LNG at its boiling point. A rise in temperature is encountered by the LNG being vented from the storage tank.

Boil Off Vapor: Usually refers to the gases generated during the storage or volatile liquefied gases such as LNG. Natural gas boils at slightly above -261°F (-163°C) at atmospheric pressure and is loaded, transported and discharged at this temperature, which requires special materials, insulation and handling equipment to deal with the low temperature and the boil-off vapor.

Boot, Boot Cooler: The section of a distillation column below the trays. For columns with very hot feeds, a portion of the bottom product is cooled and circulated through the boot or lower the temperature of the liquid in the boot and prevent depositing of coke. Many vacuum distillation columns have boot coolers.

Bottoms: 1. The heavy fractions or portions, of a crude oil that do not vaporize during fractionation/distillation. 2. The accumulation of sediments, mud and water in the bottoms of lease tanks. 3. The product coming from the bottom of a fractionating column. In general, the higher-boiling residue that is removed from the bottom of a fractionating tower. 4. The liquid level left in a tank after it has been pumped “empty” and the pump loses suction.

Bow-Tie-Analysis (BTA): 1. A qualitative risk analysis that portrays events and consequences on either side of a “bowtie”. Barriers or safeguards are shown in between the two sides. It depicts the risks in ways that are readily understandable to all levels of operations and management. 2. A type of qualitative safety review where cause scenarios are identified and depicted on the pre-event side (left side) of a bow-tie diagram. Credible consequences and scenarios outcomes are depicted on the post-event side (right side) of the diagram, and associated barrier safeguards are included(See Figure 4).

Brackish Water: Indefinite term meaning water with small amounts of salt. Saltier than fresh water.

Brainstorming: A group problem-solving technique that involves the spontaneous contribution of ideas from all members of the group primarily based on their knowledge and experience.

Brent: A large oil field in the U.K sector of the North Sea. Its name is used for a blend of crudes widely used

as a price marker or benchmark for the international oil industry. Brent crude currently has an average quality of 38°API.

Brent Blend: A light sweet crude oil produced in the North Sea; a benchmark for pricing of many foreign crude oils.

Bright Stock: Heavy lube oils (frequently the vacuum still bottoms) from which asphaltic compounds, aromatics, and waxy paraffins have been removed. Bright stock is one of the feeds to a lube oil blending plant.

British thermal unit (Btu): A standard measure of energy; the quantity of heat required to raise the temperature of 1 pound of water by 1°F.

Bromine Index: Measure of the amount of bromine reactive material in a sample; ASTM D-2710.

Bromine Number: A test that indicates the degree of unsaturation in the sample (olefins and diolefins); ASTM D-1159.

BTX: The acronyms for the commercial petroleum aromatics benzene, toluene and xylene.

Bubble Cap: 1. It is an inverted cup with a notched or slotted periphery to disperse the vapor in small bubbles beneath the surface of the liquid on the bubble plate in a distillation column. The bubble caps cause the vapor coming from the bottom to come in intimate contact with the liquid sitting on the tray. 2. A bubble cap tray has riser or chimney fitted over each hole, and a cap that covers the riser. The cap is mounted so that there is a space between riser and cap to allow the passage of vapor. Vapor rises through the chimney and is directed downward by the cap, finally discharging through slots in the cap, and finally bubbling through the liquid on the tray (See Figure 5).

Bubble Point: 1. This is the same as the boiling point. When a liquid is at its bubble point, it is said to be saturated liquid at the temperature and pressure. If we raise the pressure, the liquid’s bubble point temperature goes up. 2. The temperature and pressure at which a liquid first begins to vaporize into gas. 3. The temperature at which the first bubbles appear when a liquid mixture is heated. 4. The temperature at which a component or mixture of components begins to vaporize at a given pressure. It corresponds to the point of zero percent vaporization or 100 percent condensation. The pressure should be specified, if not one atmosphere. 5. The pressure at which gas begins to break out

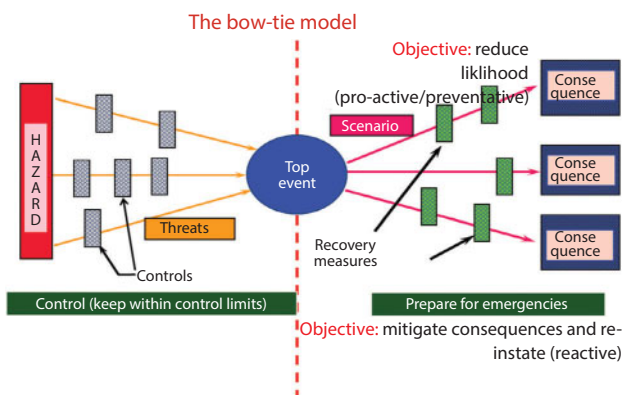
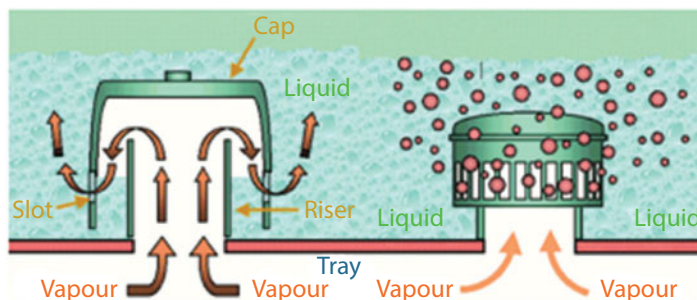


Figure 4 The Bow-Tie – Analysis.



Figure 5 A Bubble cap tray.



of under-saturated oil and form a free gas phase in the matrix or a gas cap.

Bubble Tower or Column: A fractionating tower constructed in such a way that the vapors rising up pass through different layers of condensate on a series of plates. The less volatile portions of vapor condense in bubbling through the liquid on the plate, overflow to the next lower plate and finally back to the boiler.

Bubble Tray: A horizontal tray fitted in the interior of a fractionating tower; meant to give intimate contact between rising vapors and falling liquid in the tower.

Bulk Properties: Provide a quick understanding of the type of the oil sample such as sweet or sour, light and heavy, etc. However, refineries require fractional properties of the oil sample that reflects the property and composition for specific boiling-point range to properly refine it into different end products such as gasoline, diesel, and raw materials for chemical process. Fractional properties usually contain paraffins, naphthenes and aromatics (PNA) contents, sulfur content, nitrogen content for each boiling-point range, octane number of gasoline, freezing point, cetane index and smoke point for kerosene and diesel fuels.

Bulk Station: A facility used primarily for the storage and/or marketing of petroleum products which has a total bulk storage capacity of less than 50,000 barrels and receives its petroleum products by tank car or truck.

Bulk Terminal: A facility used primarily for the storage and/or marketing of petroleum products which has a total bulk storage capacity of 50,000 barrels or more and/or receives petroleum products by tanker, barge or pipeline.

Bunker Fuel Oil: A heavy residual fuel oil used by ships, industry and large-scale heating installations.

Butadiene (C₄H₆): A diolefin with two double bonds and two isomers. A colorless gas resulting from cracking processes. Traces result from cat. cracking from catalytic dehydrogenation of butane (C₄H₁₀) or butylenes (C₄H₈) and in ethylene plants using butane, naphtha or gas oil as feeds. Butadiene is principally used to make polymers like synthetic rubber and acrylonitrile butadiene styrene (ABS) plastics.

Butane (C₄H₁₀): A normally gaseous four-carbon straight chain or branched-chain hydrocarbon extracted from natural gas or refinery gas streams. It includes normal butanes and refinery grade butanes and is designated in ASTM Specification D1835 and Gas Processors Association Specifications for commercial butane. Commercial butane is typically a mixture of normal and isobutene, predominantly normal. Hydrocarbons in the paraffin series with a general formula C_nH_{2n+2}, where n = 1, 2, 3, 4, 5, etc. To keep them liquid and economically stored, butane must be maintained under pressure or at low temperatures.

Butylene/Butene (C₄H₈): Hydrocarbons with several different isomers in the olefin series with a general formula C_nH_{2n}. Used in refining in an alkylation plant or in petrochemicals to make solvents and some polymers.

Carbon Hydrogen Ratio: The carbon hydrogen ratio is determined by the following:

$$\frac{C}{H} = \frac{74 + 15d}{26 - 15d}$$

where d is the specific gravity at 15°C

The carbon hydrogen ratios of different products are:

LPG (d= 0.56)	= 4.68
Naphtha (d = 0.72)	= 5.57
Gasoline (d = 0.73)	= 5.64
ATF (d = 0.79)	= 6.067
SK (d = 0.795)	= 6.10
JP5 (d = 0.80)	= 6.14
HSD (d = 0.845)	= 6.50
LDO (d = 0.87)	= 6.72
LSHS (d = 0.98)	= 7.85
FO (d = 0.99)	=7.97

Calorific Value: 1. A measure of the amount of energy released as heat when a fuel is burned. 2. The quantity of heat produced by the complete combustion of a fuel. This can be measured dry or saturated with water vapor, net or gross.

It is a measure of the heat producing capacity of the fuel. It is determined by:

$$Q_v = 12400 - 2100d^2$$

where

Q_v = calorific value, gross cal/g

d = density at 15°C

Note: 1 cal = 4.184 Joules

Calorific value (average) of different fuels

Fuel	Calorific value, kcal/kg
Naphtha	11330
Kerosene	11070
HSD	10860
Fuel Oil	10219
Charcoal	6900
Hard coal	5000
Fire wood	4750
Lignite-Brown coal	2310

Carbon Number: The number of carbon atoms in one molecule of a given hydrocarbon.

Carbon Residue: Carbon residue is a measure of the coke-forming tendencies of oil. It is determined by destructive distillation in the absence of air of the sample to a coke residue. The coke residue is expressed as the weight percentage of the original sample. There are two standard ASTM tests, Conradson carbon residue (CCR) and Ramsbottom carbon residue (RCR).

Catalyst: A substance present in a chemical reaction that will promote, accelerate or selectively direct a reaction, but does not take part in it by changing chemically itself. Sometimes a catalyst is used to lower the temperature or pressure at which the reaction takes place.

Catalyst/Oil Ratio (C/O): The weight of circulating catalyst fed to the reactor of a fluid-bed catalytic cracking unit divided by the weight of hydrocarbons charged during the same interval.

Catalytic Cracking: 1. The refining process of breaking down the larger, heavier, and more complex hydrocarbon molecules into simpler and lighter molecules. Catalytic cracking is accomplished by the use of a catalyst and is an effective process for increasing the yield of gasoline from crude oil. Catalytic cracking processes fresh feeds and recycled feeds. 2. A central process in reforming in which heavy gas oil range feeds are subjected to heat in the presence of a catalyst and large molecules crack into smaller molecules in the gasoline, diesel and surrounding ranges. 3. A petroleum refining process in which heavy hydrocarbon molecules are broken down (cracked) into lighter molecules by passing them over a suitable catalyst (generally heated). 4. A method of cracking that uses a catalyst to convert hydrocarbons to positively charged carbonations, which then break down into smaller molecules. This can be carried out at much lower temperatures than thermal cracking – still hot 932–1112°F (500–600°C) as compared to around 1292°F (700°C). But that difference adds up to a lot of dollars.

Catalytically Cracked Distillates: These are obtained when high-boiling non-gasoline hydrocarbons are heated under pressure in the presence of a catalyst to obtain lower-boiling gasoline components. Catalytically cracked distillates usually have high octane numbers than straight-run gasoline.

Catalytic Cycle Stock: That portion of a catalytic cracker reactor effluent that is not converted to naphtha and lighter products. This material, generally 340°F (170°C), either may be completely or partially recycled. In the latter case, the remainder will be blended to products or processed further.

Catalytic Hydrocracking: A refining process that uses hydrogen and catalysts with relatively low temperatures and high pressures for converting middle boiling or residual material to high -octane gasoline, reformer charge stock, jet fuel, and/or high-grade fuel

oil. The process uses one or more catalyst, depending upon product output, and can handle high-sulfur feedstocks without prior desulfurization.

Catalytic Hydrotreating: A refining process for treating petroleum fractions from atmospheric or vacuum distillation units (e.g., naphthas, middle distillates, reformer feeds, residual fuel oils, and heavy gas oil) and other petroleum (e.g., cat cracked naphtha, coker naphtha, gas oil, etc.) in the presence of catalysts and substantial quantities of hydrogen. Hydrotreating includes desulfurization, removal of substances (e.g., nitrogen compounds) that deactivate catalysts, conversion of olefins to paraffins to reduce gum formation in gasoline, and other processes to upgrade the quantity of the fractions.

Catalytic Polymerization (cat. poly): A process in which propylene and/or butylenes components are chemically joined to produce gasoline. A phosphoric acid (HPO_3) catalyst is usually employed in the process.

Catalyst Promoter: A substance added to a catalyst to increase the fraction of the total catalyst area which is useful for a reaction.

Catalytic Reforming: 1. A refining process using controlled heat and pressure with catalysts to rearrange certain hydrocarbon molecules, thereby converting paraffinic and naphthenic hydrocarbons (e.g., low-octane gasoline boiling range fractions) into petrochemical feedstocks and higher octane stocks suitable for blending into finished gasoline. 2. A process where low octane straight-run naphthas are chemically changed into high-octane gasoline, called reformat and to produce aromatics (BTX: benzene, toluene and xylene) for petrochemical plants over a platinum (Pt) catalyst. The reformat has higher aromatic and cyclic hydrocarbon contents. Catalytic reforming is reported into two categories, namely:

Low Pressure. A processing unit operating at less than 225 psig measured at the outlet separator.

High Pressure: A processing unit operating at either equal to or greater than 225 psig measured at the outlet separator.

Catalyst Selectivity: The relative activity of a catalyst with respect to a particular component or compound in a mixture.

Catalyst Stripping: The introduction of steam at a point where spent catalyst leaves the reactor, in order to remove or strip the hydrocarbons retained on the catalyst.

Catastrophic Incident: An incident involving a major uncontrolled emission, fire or explosion with an outcome effect zone that extends offsite into the surrounding community.

Cause: The reasons why deviations might occur.

Caustic Soda: Name used for sodium hydroxide (NaOH); used in refineries to treat acidic hydrocarbon streams to neutralize them.

Cavitation: 1. The creating of high-speed, very low pressure vapor bubbles that quickly and violently collapse. It is very detrimental to surfaces in the near proximity, and often seen in severe turbulent flow. 2. Occurs during vaporization of a pumped fluid resulting in vibration, noise, and destruction of equipment. This is when the absolute pressure of the system equals the vapor pressure of the pumped fluid. In a centrifugal pump, it results in the damage of the impeller. 3. When the pressure of liquid flowing into a centrifugal pump gets too low, liquid boils inside the pump case and generates bubbles. The discharge pressure and flow become erratically low.

Centipoise (cP): A measure of viscosity related to centistokes by adjusting for density. 1. Viscosity measurement, $1/1000^{\text{th}}$ of a poise. 2. A centipoise (cP) is $1/1000^{\text{th}}$ of a poise (P), which is the fundamental unit of dynamic viscosity in the CGS system of units. In the SI system of units, the fundamental unit of dynamic viscosity is the Pascal second (Pa.s) is equivalent of 10P.

Centistoke (cSt): Is $1/100^{\text{th}}$ of a Stoke (St), which is the fundamental unit of kinematic viscosity in the CSG system of units. In the SI system of units, the fundamental unit of kinematic viscosity is the millimeter squared per second (mm^2/s), which is equivalent to the centistokes.

Cetane (Hexadecane, $\text{C}_{16}\text{H}_{34}$): An alkane hydrocarbon with a chemical formula $\text{C}_{16}\text{H}_{34}$ used as a solvent and in cetane number determinations. 1. A pure paraffin hydrocarbon used as standard reference fuel in determining the ignition qualities of diesel fuels. 2. A number calculated from the API gravity and the D86 50% distilled for a petroleum stock. It is used to rate the performance of a fuel in diesel engines. It is arbitrarily given a cetane number of 100.

Cetane Index: 1. A number calculated from the average boiling point and gravity of a petroleum fraction in the diesel fuel boiling range, which estimates the cetane number of the fraction according to ASTM

D976. An indication of carbon – hydrogen ratio. 2. An empirical method for determining the cetane number of a diesel fuel by a formula based on API gravity and the mid-boiling point (ASTM D975). (See for example, <http://www.epa.gov/nvfel/testproc/121.pdf>.)

Cetane Number: 1. The percentage of pure cetane in a blend of cetane and alpha-methyl-naphthalene that matches the ignition quality of a diesel fuel sample. This quality, specified for middle distillate fuel, is the opposite of the octane number of gasoline. It is an indication of ease of self-ignition. 2. A term for expressing the ignition quality of a diesel fuel. 3. A measure of the ignition quality of a diesel fuel, expressed as a percentage of cetane that must be mixed with methyl naphthalene to produce the same ignition performance as the diesel fuel being rated. The higher the number, the more easily the fuel is ignited under compression. It is an important factor in determining the quality of diesel fuel. In short, the higher the cetane number, the more easily the fuel combusts in a compression setting (such as a diesel engine). The characteristic diesel “knock” occurs when fuel that has been injected into the cylinder ignites after a delay causing a late shock wave. Minimizing this delay results in less unburned fuel in the cylinder and less intense knock. Therefore higher-cetane fuel usually causes an engine to run more smoothly and quietly. This does not necessarily translate into greater efficiency, although it may in certain engines. The cetane number is determined in a single cylinder Cooperative Fuel Research (CFR) engine by comparing its ignition quality with that of reference blends of known cetane number.

$$\text{Cetane number} = 0.72 \text{ diesel index (10)}$$

Calculated Cetane Index (CCI) is determined by four variables:

$$\text{CCI} = 45.2 + (0.0892) (T_{10} N) + [0.131 + 0.901(B)] [T_{50} N] + [0.0523 - (0.420)B] [T_{90} N] + [0.00049] [(T_{10} N)^2 - (T_{90} N)^2] + 107B + 60B^2$$

where T_{10} = 10 % distillation temperature, °C
 T_{50} = 50 % distillation temperature, °C
 T_{90} = 90% distillation temperature, °C
 B = $e^{-3.5DN} - 1$
 D = Density @ 15 °C
 DN = $D - 0.85$

CFR: Combined feed ratio. The ratio of total feed (including recycle) to fresh feed.

CGO: Coker gas oil.

Charge Capacity: The input (feed) capacity of the refinery processing facilities.

Characterization Factor (CF): 1. An index of feed quality, also useful for correlating data on physical properties. The Watson or Universal Oil Property (UOP) characterization factor, K_w is defined as the cube root of the mean average boiling point in °R divided by the specific gravity. An indication of carbon to hydrogen ratio. K_w is expressed by

$$K_w = \frac{T_B^{1/3}}{\text{Sp.Gr}}$$

where

T_B = mean average boiling point, °R [°F +460]

Sp.Gr = Specific gravity at 60°F

T_B is the average boiling point in °R taken from five temperatures corresponding to 10, 30, 50, 70 and 90% volume vaporized.

2. A calculated factor used to correlate properties for petroleum streams. It is a measure of the paraffinicity of the stream and is defined as $CF = \left[\frac{\text{MABP}^{1/3}}{\text{Sp.Gr}} \right]$, where MABP = mean average boiling point temperature, °R and Sp.Gr. = specific gravity at 60°F (15.9°C) relative to water.

Typically Watson characterization factor varies between 10.5 and 13 for various crude streams. Highly paraffinic crude typically possesses a K_w of 13. On the other hand, highly naphthenic crude possesses a K_w factor of 10.5. Therefore, Watson characterization factor can be used to judge the quality of the crude oil in terms of the dominance of the paraffinic or naphthenic compounds.

Checklist: A detailed list of desired system attributes for a facility. It is used to assess the acceptability of a facility compared to accepted norms.

Clarified Oil: The heaviest stream from a catalytic cracking process after settling to remove suspended catalyst particles.

Clear Treating: An elevated temperature and pressure process usually applied to thermally cracked naphthas to improve stability and color. The stability is increased by the adsorption and polymerization of reactive diolefins in the cracked naphtha. Clay treating is used for treating jet fuel to remove surface agents that adversely affect the water separator index specifications.

Clear: Without lead. Federal regulations require that fuels containing lead must be dyed.

Cloud Point: 1. The temperature at which solidifiable compounds (wax) present in the sample begin to crystallize or separate from the solution under a method of prescribed chilling. 2. The temperature at which a noticeable cloud of crystals or other solid materials appear when a sample is cooled under prescribed conditions. Cloud point is a typical specifications of middle distillate fuels; ASTM D-2500.

Cold Filter Plugging: Is defined as that temperature at which a fuel suspension fails to flow through a standard filter when cooled as prescribed by the test method.

Coke drum: A large upright drum used as a receptacle for coke formed in the delayed coking process.

Coke: 1. A product of the coking process in the form of mostly solid, densely packed carbon atoms. 2. Deposits of carbon that settle on catalysts in cat. crackers, cat. reformers, hydrocrackers and hydrotreaters and degrade their effectiveness. 3. A carbonaceous deposit formed by the thermal decomposition of petroleum.

Coker: A refinery process in which heavy feed such as flasher bottoms, cycle oil from a catalytic cracker, or thermal cracked gas oil is cooked at high temperatures. Cracking creates light oils; coke forms in the reactors and needs to be removed after they fill up.

Coking: A refining process in which petroleum oil is heated destructively such that the heaviest materials are converted to coke. There are two processes: delayed coking and fluid coking, with delayed coking being the most widely used.

Coil: A series of pipes in a furnace through which an oil flows and is heated.

Color: It is an indication of the thoroughness of the refining process. This is determined by Saybolt Chromometer or by Lovibond Tintometer. Saybolt color of petroleum products test is used for quality control and product identification purposes on refined products having as ASTM color of 0.5 or less.

ASTM color of petroleum products applies to products having ASTM color of 0.5 or darker, including lubricating oils, heating oils, and diesel fuel oils.

Pale = 4.5 ASTM color or lighter

Red = Darker than 4.5 ASTM

Dark = Darker than 8.0 ASTM

Compressed Natural Gas: 1. Natural gas that has been compressed under high pressures (typically between 3000 and 3600 psi and held in a container;

expands when released for use as a fuel. 2. Natural gas compressed to a volume and density that is practical as a portable fuel supply (even when compressed, natural gas is not a liquid). 3. Natural gas in its gaseous state that has been compressed. 4. Natural gas that is under pressure. The pressure reduces the volume occupied for the gas so it can be contained in a smaller vessel.

Compressibility: The volume change of a material when pressure is applied.

Compressibility Factor (Z): 1. The fractional reduction in the volume of a substance with applied pressure. The compressibility factor is a measure of the compressibility of a gas, Z and used as a multiplier to adapt the ideal gas law for non-ideal gases. 2. The ratio of the actual volume of a gas divided by the volume that would be predicted by the ideal gas law, usually referred to as the "Z" factor.

$$Z = \frac{pV}{RT}$$

where p is the pressure, V is the volume, R is the universal gas constant, and T is the absolute temperature.

Compressible fluid: A fluid in which the density changes with applied pressure. The compressibility of liquids is negligible in comparison with gases and vapors. The isothermal compressibility of a gas is the change in volume per unit volume or density for a unit change in applied pressure given as:

$$c = \frac{-1}{V} \left(\frac{\partial V}{\partial p} \right)_T = \frac{-1}{\rho} \left(\frac{\partial \rho}{\partial p} \right)_T$$

Isothermal compressibility coefficients are frequently used in oil and gas engineering, transient fluid flow calculation, and in the determination of the physical properties of substances.

Compression Ratio: Is a measure of the amount of compression that takes place in an engine's cylinder. The ratio of volumes in an internal combustion cylinder when the piston is at the bottom of the stroke to that when the piston is at the top of the stroke, giving a measure of how much the air or air/fuel mixture is compressed in the compression stroke.

$$CP = \frac{V_1}{V_2} = \frac{\text{Volume when piston is @ bottom of stroke}}{\text{Volume when piston is @ top of stroke}}$$

Compressor: 1. A device that increases the pressure of gas. Commonly used as a production rate increaser by increasing the gas pressure delivered from low-pressure

gas wells to enter the pipeline. The intake into the compressor lowers the wellhead pressure, creating a larger drawdown. 2. An engine used to increase the pressure of natural gas so that it will flow more easily through a pipeline. 3. Thermodynamic machine that increases the pressure of a gas flow using mechanical energy. 4. A mechanical device used to raise the pressure of a gas. Compressors can be of three types: axial, centrifugal or reciprocating. The usual means of providing the required power are electrical motors, steam turbines or gas turbines.

Compressor Station: 1. A booster station associated with a gas pipeline that uses compressors to increase the gas pressure. When gas turbines are used to provide compressor power, stations can use some of the gas moving through the line as fuel. 2. Stations located along natural gas pipelines that recompress gas to ensure an even flow.

Condensation: Reaction in which aromatic ring structures combine to form ring structures larger than the reactants.

Condensate: 1. The relatively small amount of liquid hydrocarbon typically $C_{4,s}$ through naphtha or gas oil that gets produced in the oil patch with unassociated gas. 2. The liquid formed when a vapor cools.

Conradson Carbon: A test used to determine the amount of carbon residue left after the evaporation and pyrolysis of an oil under specified conditions. Expressed as weight percentage; ASTM D-189.

Conradson Carbon Residue (CCR): Results from ASTM test D189. It measures the coke-forming tendencies of oil. It is determined by destructive distillation of a sample to elemental carbon (coke residue), in the absence of air, expressed as the weight percentage of the original sample. A related measure of the carbon residue is called *Ramsbottom carbon residue*. A crude oil with a high CCR has a low value as refinery feedstock.

Conradson Carbon Residue (ASTM D 1289): ASTM D 4530 microcarbon residue: This procedure determines the carbon residue left after evaporation and pyrolysis of an oil sample under prescribed conditions and is a rough indicator of oil's relative coke-forming tendency or contamination of a lighter distillate fraction with a heavier distillate fraction or residue.

Carbon residue and atomic H - to - C ratio is correlated by:

$$H/C = 171 - 0.015CR \text{ (conradson)}$$

Consequence: 1. Is the ultimate harm that may occur due to a credible hazard release scenario. 2. The direct undesirable result of an accident sequence usually involving a fire, explosion, or release of toxic material. Consequence description may include estimates of the effects of an accident in terms of factors such as health impacts, physical destruction, environmental damage, business interruption, and public reaction of company prestige (See Figure 6).

Continuous Catalytic Reforming (CCR) process: Continuous catalytic reforming process occurs where the catalyst is circulated through the reactors and a regeneration step, analogous to catalytic cracking processes.

Continuous stirred tank reactor (CSTR): 1. A type of idealized chemical reactor used to contain a chemical reaction in which liquid reactants continuously flow into the reactor and products continuously removed such that there is no accumulation within the reactor. By assuming perfect mixing of the reactants within the reactor, by using a stirrer/mixer, the composition of the material is therefore assumed to be the same as the composition at all points within the reactor. 2. Reactors that are characterized by a continuous flow of reactants into and a continuous flow of products from the reaction system. Examples are the plug flow reactor and the continuous stirred flow reactor.

Control of Major Accident Hazards (COMAH): The legislation requires that businesses holding more than threshold quantities of named dangerous substances "Take all necessary measures to prevent major accidents involving dangerous substances. Limit the consequences to people and the environment of any major accidents which do occur." Plant designers need to consider whether their proposed plant will be covered by this legislation at the earliest stages.

Control of Substances Hazardous to Health (COSHH): The legislation that requires risk assessment

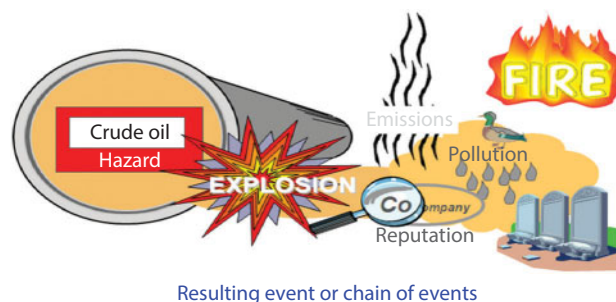


Figure 6 A consequence.

and control of hazards associated with all chemicals and used in a business which has potentially hazardous properties. Consideration of the properties of chemicals used as feedstock, intermediates, and products, is a basic part of plant design. Inherently safe design requires us to consider these issues at the earliest stage.

Conversion: 1. A measure of the completeness of a chemical reaction. It is often presented as the fraction of a particular reactant consumed by the chemical reaction. The *conversion per pass* is a measure of the limiting reactant that is converted in a chemical reactor and recycled for combination with fresh reactant feed. Not all reactions are complete within the reactor, and in many cases, unreacted reactants are separated from products and recycled for further reaction. 2. Typically, the fraction of a feedstock converted to gasoline and lighter components.

Correlation Index (CI): The U.S. Bureau of Mines factor for evaluating individual fractions from crude oil. The CI scale is based upon straight chain hydrocarbons having a CI value of 0 and benzene having a value of 100. The lower the CI value, the greater the concentrations of paraffin hydrocarbons in the fraction, and the higher the CI value, the greater the concentrations of naphthenes and aromatics. CI is an indication of the hydrocarbon to carbon ratio and the aromaticity of the sample. CI is expressed by:

$$CI = \frac{87,552}{T_B} + 473.7\text{Sp.Gr} - 456.8$$

$$CI = \frac{48640}{K} + 473.7d - 456.8$$

K = average boiling point ($K = ^\circ\text{C} + 273.15$)

d = specific gravity at 15 °C/15 °C

where

T_B = mean average boiling point, °R

Sp.Gr = specific gravity at 60°F

Corrosion: 1. The deteriorating chemical reaction of a metal with the fluids with which it is in contact. 2. The gradual decomposition or destruction of a material by chemical action, often due to an electrochemical reaction. Corrosion may be caused by (a) stray current electrolysis; (b) galvanic corrosion caused by dissimilar metals, (c) differential-concentration cells. Corrosion starts at the surface of a material and proceeds inward.

Corrosion Inhibition: Corrosion can be defined as the unwanted production of a salt from a metal.

Adding acid or oxygen is a good way for this to occur. The main way of slowing corrosion down (inhibition) is by providing an impermeable coating to stop the chemical reaction from occurring in the first place or by providing a more easily attacked metal that will be consumed first (a “sacrificial anode”).

Corrosion Inhibitor: 1. A chemical substance or combination of substances that when present in the environment, prevents or reduces corrosion. 2. Substance that slows the rate of corrosion.

Corrosive Gas: 1. A gas that attacks metal or other specified targets. Most commonly CO_2 and H_2S . Usually in association with water or water vapor. Oxygen can be described as a corrosive gas in some cases. 2. In water, dissolved, oxygen reacts readily with metals at the anode of a corrosion cell, accelerating the rate of corrosion until a film of oxidation products such as rust forms. At the cathode where hydrogen gas may form a coating on it and therefore, slows the corrosion rate, oxygen reacts rapidly with hydrogen gas forming water and again increases the rate of corrosion.

Cracking: The breaking down of higher molecular weight hydrocarbons to lighter components by the application of heat. Cracking in the presence of a suitable catalyst produces an improvement in yield and quality over simple thermal cracking.

Cracking Correction: Correction to a laboratory distillation to account for the lowering of the recorded temperatures because of thermal cracking of the sample in the distillation flask. Cracking occurs for most petroleum stocks at temperatures greater than about 650°F (344°C) at atmospheric pressure.

Cracked Stock: A petroleum stock that has been produced in a cracking operation, either catalytic or thermal. Cracked stocks contain hydrogen deficient compounds such as olefins (C_nH_{2n}) and aromatics ($\text{C}_n\text{H}_{2n-6}$).

Critical Point: The temperature and pressure at which a component or mixture of components enter a dense phase, being neither liquid nor vapor.

Critical Pressure: The vapor pressure at the critical temperature.

Critical Temperature: The temperature above which a component cannot be liquefied. For mixtures, the temperature above which all of the mixture cannot be liquefied.

Crude Assay Distillation: See *Fifteen-five (15/5) distillation*.

Crude Chemistry: Fundamentally, crude oil consists of 84–87 wt % carbon, 11–14% hydrogen, 0–3 wt % sulfur, 0–2 wt % oxygen, 0–0.6 wt % nitrogen and metals ranging from 0–100 ppm. Understanding thoroughly the fundamentals of crude chemistry is very important in various refining processes. The existence of compounds with various functional groups and their dominance or reduction in various refinery products is what is essentially targeted in various chemical and physical processes in the refinery.

Based on chemical analysis and existence of various functional groups, refinery crude can be broadly categorized into about nine categories:

- | | | |
|---|---|--|
| 1. Paraffins,
C_nH_{2n+2} ,
CH_4 , C_2H_6 ,
C_3H_8 | 4. Aromatics,
C_nH_{2n-6} , C_6H_6 ,
C_7H_8 , C_8H_{10} | 7. Oxygen containing
compounds,
R-OH, CH_3OH ,
C_6H_5OH |
| 2. Olefins,
C_nH_{2n} , C_2H_4 ,
C_3H_6 | 5. Naphthalene | 8. Resins |
| 3. Naphthenes,
C_nH_{2n} ,
C_6H_{12} | 6. Organic
sulfur
compounds,
RSH, CH_3SH ,
$R-S-R'$ | 9. Asphaltenes |

Crude and Crude Oil: 1. A range of principally carbon-hydrogen chain compounds with generally straight carbon chain lengths of C_1 (methane) to C_{60+} , compounds boiling higher than 2000°F (1094°C). The straight-chain materials are alkanes. 2. Oil as it comes from the well; unrefined petroleum. 3. The petroleum liquids as they come from the ground; formed from animal and vegetable material that is collected at the bottom of ancient seas. 4. Tarry group consisting of mixed carbon compounds with a highly variable composition. 5. A mixture of hydrocarbons that exists in liquid phase in natural underground reservoirs and remains liquid at atmospheric pressure after passing through surface-separating facilities. Depending upon the characteristics of the crude stream, it may also include the following:

- Small amounts of hydrocarbons that exist in gaseous phase in natural underground reservoirs but are liquid at atmospheric pressure after being removed from oil well (casing head) gas

in lease separators and are subsequently commingled with the crude stream without being separately measured. Lease condensate recovered as a liquid from natural gas wells in lease or field separation facilities and later mixed into the crude stream is also included.

- Small amounts of non-hydrocarbons produced from oil, such as sulfur and various metals.
- Drip gases and liquid hydrocarbons produced from tar sands, gilsonite and oil shale.
- Liquid produced at natural gas processing plants are excluded. Crude oil is refined to produce a wide range of petroleum products, including heating oils; gasoline, diesel, and jet fuels, lubricants, asphalt; ethane, propane and butane and many other products used for their energy or chemical content.

The basic types of crudes are asphalt, naphthenic, or paraffinic depending on the relative proportion of these types of hydrocarbons present.

Crude Oil Assay: Is a precise and detailed analysis on carefully selected samples of crude thoroughly representative of average production quality. It helps to assess the potential sales value of a new crude oil and to plan for its most effective utilization. Numerous important feed and product characterization properties in refinery engineering include:

1. API gravity
2. Watson Characterization factor
3. Viscosity
4. Sulfur content
5. True boiling point (TBP) curve
6. Pour point
7. Flash and fire point
8. ASTM distillation curve
9. Octane number

Crude Oil Losses: This represents the volume of crude oil reported by petroleum refineries as being lost in their operations. These losses are due to spills, contamination, fires, etc., as opposed to refinery processing losses.

Crude Oil Production: The volume of crude oil produced from oil reservoirs during given periods of time. The amount of such production for a given period is measured as volumes delivered from lease storage tanks (i.e., the point of custody transfer) to pipelines, trucks, or other media for transport to refineries

or terminals with adjustments for (1) net differences between opening and closing lease inventories, and (2) basic sediment and water (BS & W).

Crude Oil Qualities: This refers to two properties of crude oil, the sulfur content and API gravity, which affect processing complexity and product characteristics.

Cryogenics: The production and application of low-temperature phenomena. The cryogenic temperature range is usually from -238°F (-150°C) to absolute zero -460°F (-273°C), the temperature at which molecular motion essentially stops. The most important commercial application or cryogenic gas liquefaction technique is the storage, transportation and regasification of LNG.

Cryogenic Liquid or Cryogenics: Cryogenic liquids are liquefied gases that are kept in their liquid state at very low temperatures and have a normal boiling point below -238°F (-150°C). All cryogenic liquids are gases at normal temperatures and pressures. These liquids include methane (CH₄), oxygen (O₂), nitrogen (N₂), helium (He) and hydrogen (H₂). Cryogenics normally are stored at low pressures.

Cryogenic Recovery: Cryogenic recovery processes are carried out at temperatures lower than -150°F (-101°C). The low temperatures allow the plant to recover over 90% of the ethane in the natural gas. Most new gas processing plants use cryogenic recovery technology.

CSB: An acronym for Chemical Safety and Hazard Investigation Board. An agency of the U.S. government chartered to investigate chemical industry incidents, determine their root cause, and publish their findings to prevent similar incidents occurring.

Cut: That portion of crude oil boiling within certain temperature limits. Usually, the limits are on a crude assay true boiling point (TBP) basis.

Cut Point Temperature, Cut Points: A temperature limit of a cut, usually on a true boiling point basis, although ASTM distillation cut point is not uncommon. The boiling point curve most commonly used to define cut points is the true boiling point (TBP) at one atmosphere of pressure.

Cut Point Ranges: A series of cut point temperatures are defined for a petroleum stock. The cut point ranges are the temperature differences between adjacent cut point temperatures. When developing petroleum pseudo-components for a petroleum stock, cut

point ranges must be defined that include the total boiling point range of the stock.

Cutter Stock: Diluent added to residue to meet residual fuel specifications for viscosity and perhaps sulfur content. Typically cracked gas oil.

Cycloparaffin: A paraffin molecule with a ring structure.

Cycle Oil, Cycle Stock: An oil stock, containing a hydrogen deficient compound that was produced in a thermal or catalytic cracking operation.

Cyclization: Chemical reaction in which non-ring structure paraffin or olefins are converted into ring structures.

Cyclo-olefins: Unsaturated ring structure with one or two double bonds in the ring.

Darcy-Weisbach equation: An equation used in fluid mechanics to determine the pressure or head loss due to friction within a straight length of pipe for a flowing fluid. The frictional pressure drop, Δp_f (psi) is expressed by

$$\Delta p_f = f_D \left(\frac{L}{d} \right) \frac{\rho v^2}{2}$$

where

$$f_D = \left(\frac{\tau_w}{\rho v^2} \right)$$

In the form of frictional head loss, h_f (ft) is:

$$h_f = f_D \left(\frac{L}{d} \right) \frac{v^2}{2g}$$

where, τ_w is the shear stress, f_D is the Darcy friction factor, dimensionless ($f_D = 4f_F$), f_F is the fanning friction factor, L and d are the pipe length (ft) and inside diameter (ft), v is the average velocity of the fluid (ft), ρ is the fluid density (lb_m/ft³) and g is the acceleration due to gravity (ft/s²). It is known as the Darcy-Weisbach or Moody friction factor, whose value depends on the nature of the flow and surface roughness of the pipe. This Darcy friction factor is four times the Fanning friction factor (i.e., $f_D = 4f_F$). The value of the friction factor can be determined from various empirical equations and published charts such as the Moody diagram (See Figure 7).

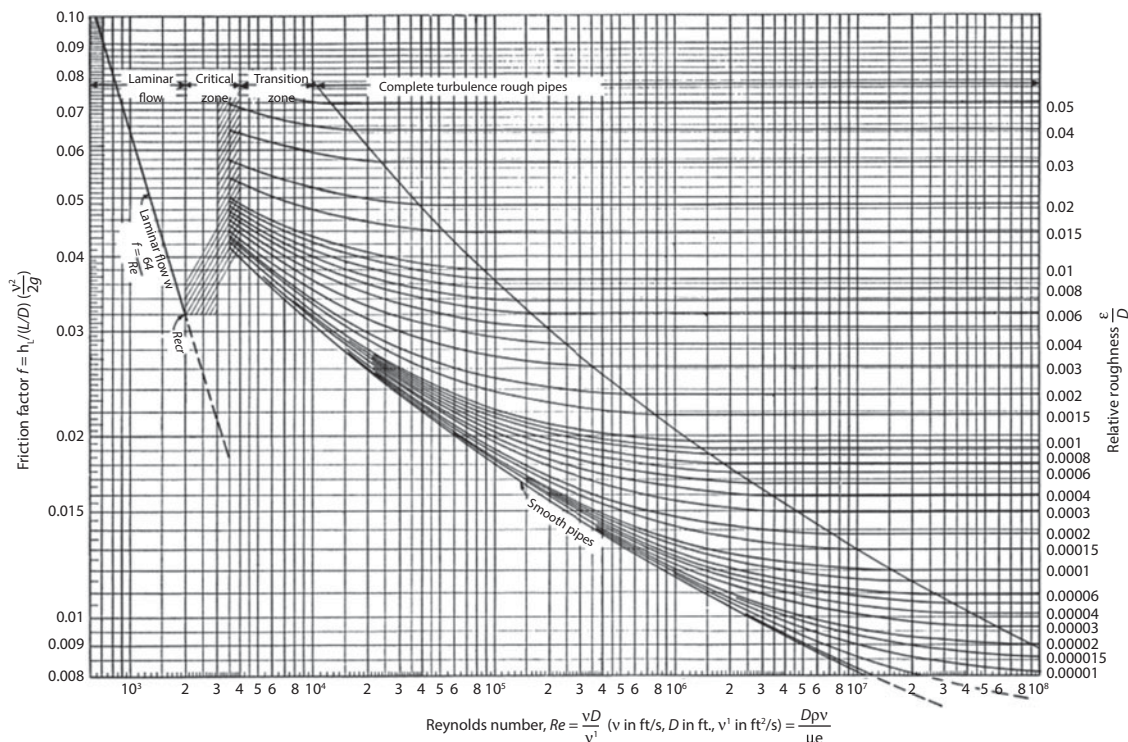


Figure 7 Moody diagram.

An empirical equation known as the Colebrook-White equation has been proposed for calculating the friction factor in the turbulent flow:

$$\frac{1}{\sqrt{f_D}} = -2 \log_{10} \left(\frac{e}{3.7D} + \frac{2.51}{Re \sqrt{f_D}} \right)$$

where

- D = pipe inside diameter, in
- e = absolute pipe roughness, in
- Re = Reynolds number, dimensionless

The term f_D (L/d) may be substituted with a head loss coefficient K (also known as the resistance coefficient) and then becomes

$$h_f = K \frac{v^2}{2g}$$

The head loss in a straight piece of pipe is represented as a multiple of the velocity head $v^2/2g$. Following a similar analysis, we can state that the pressure drop through a valve or fitting can be represented by $K(v^2/2g)$, where the coefficient K is specific to the valve and fitting. Note that this method is only applicable to turbulent flow through pipe fittings and valves. Recently K is presented by Hooper's 2-K method and Darby's 3 K- method.

DAO - Deasphalted oil: The raffinate product from the propane deasphalting unit.

D1160: ASTM laboratory distillation method for high-boiling streams. The D1160 is performed under vacuum conditions with 10 mm Hg being the most common pressure used for the test. D1160 data are normally reported at a 760 mm Hg basis.

D2887: ASTM simulated distillation method for high-boiling streams. The D2887 has an upper limit of 1000°F (538°C) and the temperatures are reported versus weight percent distilled. A normal paraffin standard is used to convert the chromatographic results to a boiling point curve.

D3710: ASTM simulated distillation method for gasoline and light naphthas. D3710 data are reported on a volume basis.

D86: ASTM laboratory distillation method conducted at atmospheric pressure for streams boiling below approximately 700°F (371°C). The D86 is the most commonly used laboratory distillation for petroleum stocks.

Deasphalting: Process for removing asphalt from petroleum fractions, such as reduced crude.

Debottlenecking: 1. Increasing production capacity of existing facilities through the modification of existing equipment to remove throughput restrictions. Debottlenecking generally increases capacity for a fraction of the cost of building new facilities. 2. The process of increasing the production capacity of existing facilities through the modification of existing equipment to remove throughput restrictions. 3. A program, typically in surface facilities and lines to remove pressure drop causing flow restrictions.

Debutanizer: A column that removes n-butaness (nC_4H_{10}) and lighter in the top product.

Decant Oil: The bottom stream from the FCC unit distillation tower after catalyst has been separated from it.

Decanted Water: Insoluble water that is drawn from a drum containing condensed hydrocarbons and water.

Decoking: The process of removing coke from catalysts in a catalytic cracker, catalytic reformer, hydrocracker or hydrotreaters. Usually heated air will oxidize the coke to carbon monoxide or carbon dioxide.

Deethanizer: A column that removes ethane (C_2H_6) and lighter in the top product.

Deflagration (i.e., "to burn down"): Is a term describing subsonic combustion propagation through heat transfer, hot burning material heats the next layer of cold material and ignites it. Most "fire" found in daily life, from flames to explosions, is deflagration. Deflagration is different from detonation, which propagates supersonically through shock waves.

Delayed Coker: A process unit in which residue is cooked until it cracks to coke and light products.

Delayed Coking: 1. A semi-continuous thermal process for the conversion of heavy stock to lighter material. The method involves pre-heating the feedstock in a pipe still, discharging into large insulated coke drums and retaining there for a particular length of time for cracking to occur. Gas, gasoline and gas oil are recovered as overhead products and finally coke is removed. 2. A process by which heavier crude oil fractions can be thermally decomposed under conditions of elevated temperatures and low pressure to produce a mixture of lighter oils and petroleum coke. The light oils can be processed further in other refinery units to meet product specifications. The coke can be used either as a fuel

or in other applications such as the manufacturing of steel or aluminum.

Dehydrogenation: A chemical reaction in which a compound loses bonded hydrogen.

Deisobutanizer: A column that removes isobutane (iC_4H_{10}) and lighter in the top product.

Demethanizer: A column that removes methane (CH_4) and lighter in the top product.

Density: The density of crude oil and petroleum fractions is usually specified in °API, specific gravity or kilograms per cubic meter (kg/m^3). The numerical values of specific gravity and kg/m^3 are equal; that is a fraction with a specific gravity of 0.873 has a density of 0.873 kg/m^3 . The API scale runs opposite to that of specific gravity, with larger values for less dense materials and smaller values for more dense fractions (water = 10°API). By definition, °API is always 60°F (15.6°C) for a liquid.

Depentanizer: A column that removes n-pentane (nC_5H_{12}) and lighter in the top product.

Depropanizer: A column that removes propane (C_3H_8) and lighter in the top product.

Desalting: A process that removes chlorides and other inorganic salts from crude oil by injecting water and applying an electrostatic field to force the salt into the aqueous phase.

Desiccant: Absorbent or adsorbent, liquid or solid that removes water or water vapor from an air stream.

Desiccant Drying: The use of drying agent to remove moisture from a stream of oil or gas. In certain product pipelines, great effort is made to remove all the water vapor before putting the line into service. To accomplish this desiccant dried air or an inert gas is pumped through the line to absorb the moisture that may be present even in the ambient air in the line.

Desiccation: The process of drying and removing the moisture within a material. It involves the use of a drying agent known as a desiccant. Desiccants that function by adsorption of moisture include silica gel and activated alumina, while chemical desiccants that function by the reaction with water to form hydrates include calcium chloride and solid sodium hydroxide. A desiccator is a container used for drying substances or for keeping them dry free of moisture. Laboratory desiccators are made of glass and contain a drying agent such as silica gel.

Design Codes (design standards): Published standards required for equipment and working practices within the chemical and process industries that represent good practice and define the level of standard of design. Developed and evolved over many years and based on tried and tested practices. There are a number of national standards organizations and institutions that provide published standards for design, materials, fabrication, testing of processes and equipment. These include the American Petroleum Institute (API), the American National Standards Institute (ANSI), the American Society of Mechanical Engineers (ASME), the American Society for Testing and Materials (ASTM), the American Iron and Steel Institute (AISI) and the British Standards Institute (BSI).

Desorption: The release of materials that have been absorbed or adsorbed in or onto a formation.

Desulfurization: The removal of sulfur, from molten metals, petroleum oil or flue gases. Petroleum desulfurization is a process that removes sulfur and its compounds from various streams during the refining process. Desulfurization processes include catalytic hydrotreating and other chemical/physical processes such as adsorption. Desulfurization processes vary based on the type of stream treated (e.g., naphtha, distillate, heavy gas oil, etc.) and the amount of sulfur removed (e.g., sulfur reduction to 10 ppm). *See also Catalytic Hydrotreating.*

Desuperheating zone: A section of a distillation/fractionating column where a superheated vapor is cooled and some liquid is condensed. FCC main fractionators have a desuperheating zone.

Detonation (“to thunder down”): Is a type of combustion involving a supersonic exothermic front accelerating through a medium that eventually drives a shock front propagating directly in front of it. Detonations occur in both conventional solid and liquid explosives, as well as in reactive gases. The velocity of detonation in solid and liquid explosives is much higher than that in gaseous ones, which allows the wave system to be observed with greater detail.

An extraordinary variety of fuels may occur as gases, droplet fogs, or dust suspensions. Oxidants include halogens, ozone, hydrogen peroxide and oxides of nitrogen. Gaseous detonations are often associated with a mixture of fuel and oxidant in a composition somewhat below conventional flammability ratios. They happen most often in confined systems, but they sometimes occur in large vapor clouds. Other materials, such as

acetylene, ozone and hydrogen peroxide are detonable in the absence of oxygen. See also Knocking.

Dewaxing: The removal of wax from lubricating oils, either by chilling and filtering solvent extraction, or selective hydrocracking.

Dew Point: 1. A vapor at its dew point temperature is on the verge of starting to condense to a liquid. Cool the vapor by 1°F, or raise its pressure by 1 psi and it will form drops of liquid. Air at 100% relative humidity is at its dew point temperature. Cool it by 1°F and it starts to rain. 2. The temperature and pressure at which the first drop of liquid will condense for a component or mixture of components. 3. The temperature at a given pressure at which a vapor will form a first drop of liquid on the subtraction of heat. Further cooling of the liquid at its dew point results in condensation of part or all the vapors as a liquid. 4. The temperature at which vaporized materials start to condense into liquid form. 5. The temperature at which liquids begin to condense from the vapor phase in a gas stream. *See also Bubble point.*

Diene: Same as diolefin.

Diesel: 1. An internal combustion engine in which ignition occurs by injecting fuel in a cylinder where air has been compressed and is at very high temperature, causing self-ignition. 2. Distillate fuel used in a diesel engine. *See the Diesel engine.*

Diesel Fuel: A fuel produced for diesel engines with typical ASTM 86 boiling point range of 450–675 °F (233–358°C).

Diesel Index (DI): A measure of the ignition quality of a diesel fuel. Diesel index is defined as

$$DI = \frac{(^{\circ}\text{API})(\text{Aniline Point})}{100}$$

The higher the diesel index, the more satisfactory the ignition quality of the fuel. By means of correlations unique to each crude and manufacturing process, this quality can be used to predict the cetane number (if no standardized test for the latter is available).

Diolefin: C_nH_{2n}: Paraffin-type molecule except that it is missing hydrogen atoms causing it to have two double bonds somewhere along the chains.

DIPE: Di-isopropyl ether. An oxygenate used in motor fuels.

Disposition: the components of petroleum disposition are stock change, crude oil losses, refinery

inputs, exports and products supplied for domestic consumption.

Distillate Fuel Oil: A general classification for one of the petroleum fractions produced in conventional distillation operations. It includes diesel fuels and fuel oils. Products known as No. 1, No. 2, and No. 4 diesel fuel are used on highway diesel engines, such as those in trucks and automobiles, as well as off-highway engines, such as those in railroad locomotives and agricultural machinery. Products known as No.1, No. 2, and No. 4 fuel oils are used primarily for space heating and electric power generation.

No. 1 Distillate. A light petroleum distillate that can be used as either a diesel fuel or a fuel oil.

No. 1 Diesel Fuel. A light distillate fuel oil that has distillation temperatures of 550°F (288°C) at the 90% point and meets the specifications defined in ASTM Specification D 975. It is used in high-speed diesel engines generally operated under frequent speed and load changes, such as those in city buses and similar vehicles.

No. 1 Fuel Oil. A light distillate fuel oil that has distillation temperatures of 400°F (204°C) at the 10 percent recovery point and 550°F (288°C) at the 90% point and meets the specifications defined in ASTM Specifications D 396. It is used primarily as fuel for portable outdoor stoves and portable outdoor heaters.

No. 2 Distillate: A petroleum distillate that can be used as either a diesel fuel or a fuel oil.

No. 2 Diesel Fuel: A fuel that has distillation temperature of 500°F (260°C) at the 10% recovery point and 640°F (338°C) at the 90% recovery point and meets the specifications defined in ASTM Specification D 975. It is used in high-speed diesel engines that are generally operated under uniform speed and load conditions, such as those in railroad locomotives, trucks and automobiles.

Low Sulfur No. 2 Diesel Fuel. No. 2 diesel fuel that has a sulfur level no higher than 0.05% by weight. It is used primarily in motor vehicle diesel engines for on-highway use.

High Sulfur No. 2. Diesel Fuel. No. 2 diesel fuel that has sulfur level above 0.05% by weight.

No. 2 Fuel Oil (Heating Oil): A distillate fuel oil that has distillation temperatures of 400°F (204°C) at the 10% recovery point and 640°F (338°C) at the 90% recovery point and meets the specifications defined in ASTM Specification D 396. It is used in atomizing type burners for domestic heating or for moderate capacity commercial/industrial burner units.

No. 4 Fuel. A distillate fuel oil made by blending distillate fuel oil and residual fuel oil stocks. It conforms with ASTM Specification D 396 or Federal Specification VV - F- 815C and is used extensively in industrial plants and in commercial burner installations that are not equipped with preheating facilities. It also includes No. 4 diesel fuel used for low- and medium-speed diesel engines and conforms to ASTM Specification D975.

No. 4 Diesel Fuel. See No. 4 Fuel.

No. 4 Fuel Oil. See No. 4 Fuel.

Distillate: 1. The liquid obtained by condensing the vapor given off by a boiling liquid. 2. Any stream except the bottoms coming from a fractionator. 3. The products or streams in the light gas oil range such as straight run light gas oil, cat. cracked light gas oil, heating oil or diesel.

Distillation: Same as fractionation. A separation process that results in separated products with different boiling ranges. Distillation is carried out in a way that the materials being separated are not subjected to conditions that would cause them to crack or otherwise decompose or chemically change. It is a physical process.

Distillation Column: A tall vertical cylindrical vessel used for the process of distillation. Hot vapor rises up the column, which is brought into intimate contact with cooled liquid descending on stages or trays for a sufficient period of time so as to reach equilibrium between the vapor and the liquid. The vapor rises up from the tray below through perforations in the tray, and the liquid on the tray flows over a weir to the tray below. In this way, the more volatile component increases in concentration progressively up the column. In continuous distillation, fresh feed is admitted at the tray corresponding to the same composition. Below the feed point, the section of column is known as the stripping section, while above is referred to as the rectifying section. A reboiler heat exchanger is used to boil the bottom product and produce vapor for the column. A condenser is used to condense some or all of the vapor from the top of the column. A small portion of liquid is returned to the column as reflux. The height of the column is an indication of the ease or difficulty of separation. For example, an ethylene splitter in a refinery used to separate ethylene from ethane, which have close boiling points, requires many trays and the column is very tall. The width of the column is an indication of the internal vapor and liquid rates.

Distillation Curves: In addition to True Boiling Point (TBP) or good fractionation distillations, there are at least three other major types of distillation curves or ways of relating vapor temperature and percentage vaporized: (a) equilibrium flash vaporization, (b) ASTM or non-fractionating distillations, and (c) Hempel or semi-fractionating distillations.

Distillation Range: See *boiling range*.

Distillation Train: A sequence of distillation columns used to separate components from a multicomponent feed. Each column is required to perform a particular separation of either a pure component or a cut between two components. For example, in the separation of four components ABCD in a mixture in which A is the most volatile and D is the least, then the five possible separation sequences requiring three columns are:

Separation	Column 1	Column 2	Column 3
1	A:BCD	B:CD	C:D
2	A:BCD	BC:D	B:C
3	AB:CD	A:B	C:D
4	ABC:D	A:BC	B:C
5	ABC:D	AB:C	A:B

Where it is required to separate a larger number of components, the number of possible separation sequences becomes much larger according to the relationship

$$N = \frac{(2n - 2)!}{n!(n - 1)!}$$

Where N is the number of sequences and n is the number of components:

Components (n)	4	5	6	7	8	9	10
Sequences (N)	5	14	42	132	429	1430	4862

Distributed Component: A component that appears in both the top and bottom products from a distillation/fractionating column separating zone.

Distributed Control System: A system which divides process control functions into specific areas interconnected by communications (normally data highways) to form a single entity. It is characterized by digital controllers and typically by central operation interfaces.

Distributed control systems consist of subsystems that are functionally integrated but may be physically separated and remotely located from one another. Distributed control systems generally have at least one shared function within the system. This may be the controller, the communication link or the display device. All three of these functions may be shared.

A system of dividing plant or process control into several areas of responsibility, each managed by its own Central Processing Unit, in which the whole is interconnected to form a single entity usually by communication buses of various kinds.

Distributor: A device in a vessel that disperses either liquid or vapor to promote better circulation.

Doctor Test: A method for determining the presence of mercaptan sulfur petroleum products. This test is used for products in which a “sweet” odor is desirable for commercial reasons, especially naphtha; ASTM D-484.

Dow Fire and Explosion Index (F & EI): A method (developed by Dow Chemical Company) for ranking the relative fire and explosion risk associated with a process. Analysts calculate various hazard and explosion indexes using material characteristics and process data.

Downcomer: A device to direct the liquid from a distillation column tray to the next lower distillation tray.

Draw, Side Draw: A product stream withdrawn from a distillation column at a location above the bottom tray and below the top tray. Draws may be vapor or liquid phase.

Dropping Point of Lubricating Greases: Dropping points are used for identification and quality control purposes, and can be an identification of the highest temperature of utility for some applications. This is the temperature at which grease passes from a semisolid to a liquid state under prescribed conditions.

Dry Gas: All C₁ to C₃ material whether associated with a crude or produced as a by-product of refinery processing. Convention often includes hydrogen in dry gas yields.

Effective Cut Points: Cut points that can be considered a clean cut, ignoring any tail ends.

Emergency: A condition of danger that requires immediate action.

Emergency Isolation Valve (EIV): A valve that, in event of fire, rupture, or loss of containment, is used to stop the release of flammable or combustible liquids, combustible gas, or potentially toxic material. An EIV can be either hand-operated or power-operated (air, hydraulic, or electrical actuation).

Emergency Shutdown (ESD): A method to rapidly cease the operation of a process and isolate it from incoming and outgoing connections or flows to reduce the likelihood of an unwanted event from continuing or occurring. Critical valves shut to isolate sections of the process. Other valves may be opened to depressurize vessels or rapidly discharge contents of reactors to quench tanks. Emergency shutdowns may occur due to changes in process conditions causing unstable or unsafe operating conditions, a failure in the control system, operator intervention causing unsafe conditions, plant and pipe failure or some other external event such as an electrical storm or natural catastrophes like earthquakes or coastal flooding.

Emulsion: A colloidal suspension of one liquid dispersed within another. The dispersed phase has droplet sizes usually less than 1 mm. Surfactants or emulsifiers are surface-active agents and used to stabilize emulsions. In the offshore oil industry, emulsions form at the interface of water and oil in crude oil gravity separators. Sufficient hold-up time is used to separate the emulsion, or alternatively surface-active agents are used to encourage separation.

Endothermic reaction: 1. A chemical reaction that absorbs heat from its surroundings in order for the reaction to proceed. Such reactions have a positive enthalpy change and therefore do not occur spontaneously. 2. A reaction in which heat must be added to maintain reactants and products at a constant temperature.

E85: Fuel containing a blend of 70 to 85% ethanol.

End Point (final boiling point): 1. The highest boiling point recorded for a laboratory distillation. Usually, there is some residual material in the laboratory still, and the end point is not the highest boiling point material in the mixture being distilled. 2. The lowest temperature at which virtually 100% of petroleum product will boil off to vapor form.

Energy: The capacity or ability of a system to do work. It may be identified by type as being kinetic, potential, internal, and flow or by source such as electric, chemical, mechanical, nuclear, biological, solar, etc. Energy

can be neither created nor destroyed, but converted from one form to another. It can be stored as potential energy, nuclear, and chemical energy, whereas kinetic energy is the energy in motion of a body defined as the work that is done in bringing the body to rest. The internal energy is the sum of the potential energy and kinetic energy of the atoms and molecules in the body. Energy as the units, Btu, cal, Joules.

Energy Balance: 1. An accounting of the energy inputs and outputs to a process or part of a process, which is separated from the surroundings by an imaginary boundary. All energy forms are included in which the energy input across the boundary must equal the energy output plus any accumulation within the defined boundary. When the conditions are steady and unchanging with time, the energy input is equal to the energy output. The most important energy forms in most processes are kinetic energy, potential energy, enthalpy, heat and work. Electrical energy is included in electrochemical processes and chemical energy is in processes involving chemical reactions that occur in various reactor types (e.g., batch, continuous stirred tank, plug flow, fixed and catalytic reactors). 2. Summation of the energy entering a process and the summation of the energy leaving a process. They must equal for a steady-state process.

Energy Management: Is the planning and operation of energy production and energy consumption units. Objectives are resource conservation, climate protection and cost savings, while the users have permanent access to the energy they need. Energy management is the proactive, organized and systematic coordination of procurement, conversion, distribution and use of energy to meet the requirements, taking into account the environmental and economic objectives. It is also the solution for electric power producers to reduce emissions and improve efficiency and availability. Energy management requires reducing NO_x and greenhouse gas emissions, improving fuel efficiency and reducing SCR operating costs, and streamlining the detection, diagnosis and remediation of plant reliability, capacity and efficiency problems. Energy management programs incorporate energy policies, benchmarking, local and corporate goals, types of energy audits and assessments, reporting systems and integration of energy efficiency elements into engineering procedures and purchasing protocols.

Pinch analysis is a tool that is employed in energy management of chemical facilities and is a methodology

for minimizing energy consumption of chemical processes by calculating thermodynamically feasible energy targets (or minimum energy consumption) and achieving them by optimizing heat recovery systems, energy supply methods and processing operating conditions. It is also known as process integration, heat integration, energy integration or pinch technology (See Process Integration).

Engler Distillation: A standard test for determining the volatility characteristics by measuring the percent distilled at various specified temperature (see ASTM D86).

Engine knocking (knock, detonation, spark knocking, pinging, or pinking): Spark ignition in internal combustion engines occur when combustion of the air/fuel mixture in the cylinder does not start off correctly in response to ignition by the spark plug, but one or more pockets of air/fuel mixture explode outside the envelope of the normal combustion front.

The fuel-air charge is meant to be ignited by the spark plug only, and at a precise point in the piston's stroke. Knock occurs when the peak of the combustion process no longer occurs at the optimum moment for the four-stroke cycle. The shock wave creates the characteristic metallic "pinging" sound, and cylinder pressure increases dramatically. Effects of engine knocking range from inconsequential to completely destructive. See also Knocking.

Engineering line diagram (ELD): A diagrammatic representation of a process. Also referred to as *engineering flow diagram*. It features all process equipment and piping that is required for start-up and shutdown, emergency and normal operation of the plant. It also includes insulation requirements, direction of flows, identification of the main process and start-up lines, all instrumentation, control, and interlock facilities, key dimensions and duties of all equipment, operating and design pressure and temperature for vessels, equipment elevations, set pressures for relief valves, and drainage requirements.

Engineering, Procurement, and Construction Contract: 1. A legal agreement setting out the terms for all activities required to build a facility to the point that it is ready to undergo preparations for operations as designed. 2. The final contracting phase in the development of the export portion of the LNG chain that defines the terms under which the detailed design, procurement, construction, and commissioning of the facilities

will be conducted. Greenfield LNG project development involves a wide range of design, engineering, fabrication and construction work far beyond the capabilities of a single contractor. Therefore, an LNG project developer divides the work into a number of segments, each one being the subject of an engineering, procurement and construction (EPC) contract. 3. Contract between the owner of a liquefaction plant and an engineering company for the project development and erection. See *Front-End Engineering and Design Contract*.

Enthalpy (H): The thermal energy of a substance or system with respect to an arbitrary reference point. The enthalpy of a substance is the sum of the internal energy and flow of energy, which is the product of the pressure and specific volume.

$$H = U + pV$$

The reference point for gases is 273K and for chemical reactions is 298K.

Enthalpy balance: A form of energy accounting for a process in which the stream energies to and from the process are expressed as enthalpies. At steady state, the total enthalpy into a process is equal to the total enthalpy out. Where there is an inequality, there is either a loss or an accumulation of material with an associated loss increase in enthalpy. An enthalpy balance is used to determine the amount of heat that will be generated in the process or that needs to be removed to ensure that the process operates safely and to specification.

Entrainment: A non-equilibrium process by which liquids are mechanically carried into a vapor leaving a process vessel or contacting device.

Entrance and exit losses: The irreversible energy loss caused when a fluid enters or leaves an opening, such as into or out of a pipe into a vessel. Where there is a sudden enlargement, such as when a pipe enters a larger pipe or vessel, eddies form and there is a permanent energy loss expressible as a head loss as:

$$H_{exit} = \frac{v^2}{2g} \left(1 - \frac{a}{A} \right)^2$$

Where v is the velocity in the smaller pipe, a is the cross-sectional area of the smaller pipe, A is the cross-sectional area of the larger pipe. For a considerable enlargement the head loss tends to

$$H_{exit} = \frac{v^2}{2g}$$

With a rapid contraction, it has been found experimentally that the permanent head loss can be given by:

$$H_{exit} = K \frac{v^2}{2g}$$

where for very large contraction, $K=0.5$

Entropy (dS): The extent to which energy in a closed system is unavailable to do useful work. An increase in entropy occurs when the free energy decreases or when the disorder of molecules increases. For a reversible process, entropy remains constant such as in a friction free adiabatic expansion or compression. The change in entropy is defined as:

$$dS = \frac{dQ}{T}$$

where Q is the heat transferred to or from a system, and T is the absolute temperature. However, all real processes are irreversible, which means that in a closed system there is a small increase in entropy.

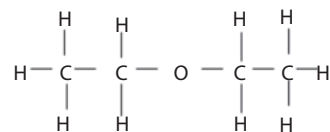
Environmental Protection Agency (EPA), United States: 1. Governmental agency, established in 1970. Its responsibilities include the regulation of fuel and fuel additives. 2. The U.S. federal agency that administers federal environmental policies, enforces environmental laws and regulations, performs research, and provides information on environmental subjects. The agency also acts as chief advisor to the president on American environmental policy and issues. 3. A federal agency created in 1970 to permit coordinated and effective government action, for protection of the environment by the systematic abatement and control of pollution, through integration of research monitoring, standard setting, and enforcement activities. 4. U.S. pollution control enforcer. 5. A regulatory agency established by the U.S. Congress to administer that nation's environmental laws. Also called the US EPA.

Error: Discrepancy between a computed, observed or measured value or condition and the true specified or theoretically correct value or condition.

Ethane (C₂H₆): A colorless gas; a minor constituent of natural gas and a component in refinery gas that, along with methane is typically used as refinery fuel. An important feedstock for making ethylene.

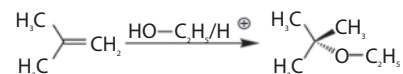
Ether (C₂H₅OC₂H₅): 1. A generic term applied to a group of organic chemical compounds composed of carbon, hydrogen and oxygen, characterized by an oxygen atom attached to two carbon atoms (e.g., methyl

tertiary butyl ether). 2. Any carbon compound containing the functional group (C - O - C). Commonly used ether is diethyl ether, which is used as an anesthetic.



Ethylene (C₂H₄): A colorless gas created by cracking processes. In refineries, it is typically burned with the methane and ethane. In chemical plants, it is purposefully made in ethylene plants and it is basic building block for a wide range of products including polyethylene and ethyl alcohol.

ETBE: Ethyl Tertiary Butyl Ether (CH₃)₃CO C₂H₅: 1. A colorless, flammable, oxygenated hydrocarbon blend stock. It is produced by the catalytic etherification of ethanol with isobutylene. 2. An oxygenated gasoline blending compound to improve octane and reduce carbon monoxide emissions. It is commonly used as an oxygenate gasoline additive in the production of gasoline from crude oil.



Equation of state: A relationship that links the pressure, volume and temperature of an amount of a substance. It is used to determine thermodynamic properties such as liquid and vapor densities, vapor pressures, fugacities and deviations from ideality and enthalpies. Various equations of state have been developed to predict the properties of real substances. Commonly used equations of state include the ideal gas law, virial equation, van der Waals' equation, Peng-Robinson, Soave-Redlich Kwong and Lee-Kesler equations. Cubic equations are relatively easy to use and are fitted to experimental data. The van der Waals equation is comparatively poor at predicting state properties. The Lee-Kesler model, which is based on the theory of corresponding states, uses reduced temperature and pressure and covers a wide range of temperatures and pressures.

Equilibrium: A condition or state in which a balance exists within a system, which may be physical or chemical. A system is in equilibrium if it shows no tendency to change its properties with time. Static equilibrium occurs if there is no transfer of energy across the system boundary, whereas dynamic equilibrium is when transfer occurs, but the net effect of the energy is

zero. Thermodynamic equilibrium occurs when there is no heat or work exchange between a body and its surroundings. Chemical equilibrium occurs when a chemical reaction takes place in the forward direction, when reactants form products at exactly the same rate as the reverse reaction of products revert to their original reactant form.

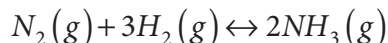
Equilibrium constant (K_c): A reversible process, chemical or physical in a closed system will eventually reach a state of equilibrium. The equilibrium is dynamic and may be considered as a state at which the rate of the process in one direction exactly balances the rate in the opposite direction. For a chemical reaction, the equilibrium concentrations of the reactants and products will remain constant providing the conditions remain unchanged for the homogeneous system:



The ratio of the molar concentrations of products to reactants remain constant at a fixed temperature, the equilibrium constant, K_c is:

$$K_c = \frac{[C]^y [D]^z}{[A]^w [B]^x}$$

For the Haber process for the synthesis of ammonia, nitrogen is reacted with hydrogen as:



The equilibrium constant is expressed as partial pressure as:

$$K_c = \frac{[NH_3]^2}{[N_2][H_2]^3} = \frac{p_{NH_3}^2}{p_{N_2} p_{H_2}^3}$$

Equilibrium K - value (K-value): the ratio of the mole fraction in the vapor divided by the mole fraction in the liquid for a component in the equilibrium state. Each K value corresponds to a given temperature, pressure and mixture composition.

Equilibrium ratio (K): the ratio of the mole fraction in the vapor phase y of a component in a mixture, to the mole fraction in the liquid phase x , at equilibrium.

$$K_A = \frac{y_A}{x_A}$$

It is a function of both temperature and pressure. The relative volatility α , is less dependent on temperature

and pressure than the equilibrium constant where for an ideal mixture of two components, A and B:

$$\alpha_{AB} = \frac{K_A}{K_B}$$

Equilibrium-Flash Vaporizer: When a mixture is heated without allowing the vapor to separate from the remaining liquid, the vapor assists in causing the high-boiling parts of the mixture to vaporize. Thus continuous-flash vaporization is used in almost all plant operations. The equipment is used to determine a flash vaporization curve, where a series of runs at different temperatures are conducted, and each run constitutes one point (of temperature and percentage vaporized) on the flash curve.

Equipment Reliability: The probability that, when operating under stated environment conditions, process equipment will perform its intended function adequately for a specified exposure period.

Equivalent length: A method used to determine the pressure drop across pipe fittings such as valves, bends, elbows and T-pieces. The equivalent length of a fitting is that length of pipe that would give the same pressure drop as the fitting. Since each size of pipe or fitting requires a different equivalent length for any particular type of fitting, it is usual to express equivalent length as so many pipe diameters and this number is independent of pipe. For example, if a valve in a pipe of diameter d , is said to have an equivalent length, n , pipe diameters, then the pressure drop due to the valve is the same as that offered by a length, n , of the pipe.

Ergun equation: Sabri Ergun developed an equation in 1952 to determine the pressure drop per unit length of a fixed bed of particles such as catalyst at incipient gas velocity, v :

$$\frac{-\Delta p}{L} = \frac{150(1-e)^2 \mu v}{\phi e^3 d^2} + \frac{1.75(1-e) \rho v^2}{\phi e^3 d}$$

Where $-\Delta p/L$ is the pressure drop over the depth of bed, e is the bed voidage, d is the mean particle diameter, ρ is the fluid density, μ is the fluid viscosity, and ϕ is the sphericity. The incipient point of fluidization corresponds with the highest pressure drop at the minimum fluidization velocity.

Erosion: The physical removal of material from a surface by mechanisms that exclude chemical attack. The usual phenomenon that causes erosion is

impingement by either liquid droplets or entrained solid particles. If there are no corrosive substances present, then in many cases, the most common mechanism for material damage due to erosion is impingement by solid particles.

Exothermic reaction: 1. A chemical reaction that gives out/liberates heat. No energy input is required for the reaction to proceed. It has a negative enthalpy change and therefore under the appropriate conditions the reaction will occur spontaneously. Chemical reactors used to contain exothermic reactions therefore require cooling facilities to remove the excess heat that is generated and to maintain a constant temperature. 2. A reaction in which heat is evolved. Alkylation, polymerization, and hydrogenation reactions are exothermic reactions.

Expansion Loop: Piping thermally expands as it gets hot. Allowance must be made for the growth in pipe length, otherwise the pipe will break by cracking at its welds. A fractionator at the Good Hope Refinery in the U.S. was burned down because of such an omission.

Explosion: 1. The sudden conversion of potential energy (chemical or mechanical) to kinetic energy with the production and release of gases under pressure, or the release of a gas under pressure. 2. A release of energy that causes a pressure discontinuity or blast wave.

Exports: Shipments of crude oil and petroleum products from countries, e.g., in the United States. shipments from the 50 states and the District of Columbia to foreign countries, Puerto Rico, the Virgin Islands, and other U.S. possessions and territories.

Failure: 1. Termination of the ability of a functional unit to perform a required function. 2. An unacceptable difference between expected and observed performance.

Fail Safe: A system design or condition such that the failure of a component, subsystem or system or input to it, will automatically revert to predetermined safe static condition or state of least critical consequence for the component, subsystem or system.

Fail Steady: A condition wherein the component stays in its last position when the actuating energy source fails. May also be called Fail in Place.

Failure Mode: The action of a device or system to revert to a specified state upon failure of the utility power source that normally activates or controls the

device or system. Failure modes are normally specified as fail open (FO), fail close (FC) or fail steady (FS) which will result in a fail safe or fail to danger arrangement.

Failure Mode and Effects Analysis (FMEA): A systematic, tabular method for evaluating and documenting the causes and effects of known types of component failures.

Fault: Abnormal condition that may cause a reduction in, or loss of, the capability of a functional unit to perform a required function.

Fault Tree: A logic method that graphically portrays the combinations of failures that can lead to a specific main failure or accident of interest.

Field Production: Represents crude oil production on leases, natural gas liquids production at natural gas processing plants, new supply of other hydrocarbons/oxygenates and motor gasoline blending components and fuel ethanol blended into finished motor gasoline.

Final Boiling Point (FBP): The final boiling point of a cut, usually on an ASTM distillation basis.

Fifteen-five (15/5) distillation: A laboratory batch distillation performed in a 15-theoretical plate fractionating column with a 5:1 reflux ratio. A good fractionation results in accurate boiling temperatures. For this reason, this distillation is referred to as the true boiling point distillation. This distillation corresponds very closely to the type of fractionation obtained in a refinery.

Fire: 1. A combustible vapor or gas combining with an oxidizer in a combustion process manifested by the evolution of light, heat and flame. 2. The rapid thermal oxidation (combustion) of a fuel source resulting in heat and light emission. There are various types of fire, classified by the type of fuel and associated hazards. In the U.S., the National Fire Protection Association (NFPA) classifies fires and hazards by types of fuels or combustible in order to facilitate the control and extinguishing of fires:

- Class A Ordinary combustibles such as wood, cloth, paper, rubber and certain plastics.
- Class B Flammable or combustible liquids, flammable gases, greases and similar materials.
- Class C Energized electrical equipment.
- Class D Combustible metals, such as magnesium, titanium, zirconium, sodium, and potassium.

Fireball: The atmospheric burning of a fuel-air cloud in which the energy is mostly emitted in the form of radiant heat. The inner core of the fuel release consists of almost pure fuel whereas the outer layer in which ignition first occurs is a flammable fuel-air mixture. As buoyancy forces of the hot gases begin to dominate, the burning cloud rises and becomes more spherical in shape.

Fire Point: Is the temperature well above the flash point where the product could catch a fire. The fire point and flash point are always taken care of in the day to day operation of a refinery. (See also *Flash point*).

Fireproof: Resistant to a specific fire exposure. Essentially nothing is absolutely fireproof, but some materials or building assemblies are resistant to damage or fire penetration at certain levels of fire exposures that may develop in the petroleum, chemical or related industries.

Fireproofing: A common industry term used to denote materials or methods of construction used to provide fire resistance for a defined fire exposure and specified time. Essentially nothing is fireproof if it is exposed to high temperatures for extended period of time.

Fire suppression system: A method, device or system used to detect a fire or ignition source, and to extinguish the fire in sufficient time so as to prevent structural damage and/or debilitation of personnel.

Fire triangle: A way of illustrating the three factors necessary for the process of combustion which are fuel, oxygen and heat. All three are required for combustion to occur. A fire can therefore be prevented or extinguished by removing one of the factors. A fire is not able to occur without sufficient amounts of all three (See Figure 8).

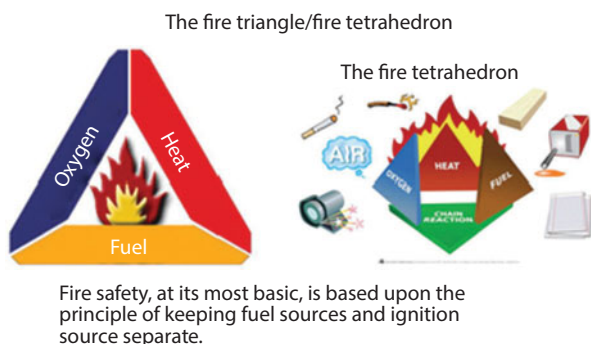


Figure 8 Diagram of a fire triangle.

First law of thermodynamics: A law that is applied to the conservation of energy in which the change in internal energy, ΔU of a system is equal to the difference in the heat added, Q to the system and the work done by the system:

$$\Delta U = Q - W$$

When considering chemical reactions and processes, it is more usual to consider situations where work is done on the system rather than by it.

Fittings: Connections and couplings used in pipe-work and tubing. The type of fittings used depends largely on the wall thickness as well as in part on the properties of the pipes and tubes including welds, flanges and screw fittings. Fittings include elbow, bends, tees, reducers and branches.

Fixed Bed: A place in a vessel for catalyst through or by which feed can be passed for reactions, as opposed to a fluidized bed, where the catalyst moves with the feed.

Fixed-Bed Reactor: A reactor in which the catalyst is loaded into an immovable bed. The reactants enter the top of the bed, and the products exit from the bottom of the bed. The process must be taken off line, and hot gases circulated through the catalyst bed to burn off coke deposits and restore the catalyst activity.

Flame: The glowing gaseous part of a fire.

Flammable: 1. A substance or material that has the ability to support combustion and be capable of burning with a flame. It is easily ignited or highly combustible. The term is more widely used than inflammable as this is often confused with incombustible, which means an inability or lack of ability to combust. A flammable liquid is a liquid that has the capability of catching fire. In the U.S., the National Fire Protection Association defines a flammable liquid as a liquid that has a flash point below 100°F (37.8°C) and a vapor pressure not exceeding 40 psia (2.72 bar) at that temperature. 2. In general sense refers to any material that is easily ignited and burns rapidly. It is synonymous with the term inflammable that is generally considered obsolete; due to its prefix which may be incorrectly misunderstood as not flammable (e.g., incomplete is not complete).

Flammable Liquid: 1. As defined by NFPA 30, a liquid having a flash point below 100°F (37.8°C) and having a vapor pressure not exceeding 2068 mm Hg (40 psia) at 100°F (37.8°C) as determined under specific conditions. 2. Any liquid having a flash point below

100°F (37.8°C), except any liquid mixture having one or more components with a flash point at or above the upper limit that makes up 99% or more of the total volume of the mixture, 3. Liquid with a flash point below 100°F (37.8°C). At that temperature, vapors from the substance can be ignited by a flame, spark or other sources of ignition.

Flammability Limit: 1. The flammability limit of a fuel is the concentration of fuel (by volume) that must be present in air for an ignition to occur when an ignition source is present. 2. The range of gas or vapor amounts in air that will burn or explode if a flame or other ignition source is present. Importance: The range represents an unsafe gas or vapor mixture with air that may ignite or explode. Generally, the wider the range the greater the fire potential.

Flange: It is a flat end of a pipe that is used to bolt up to a flange on another piece of piping. Bolts, with nuts at each end, are used to force the flanges together.

Flange Rating: Connections on vessels, spool pieces and valves have a pressure rating called a flange rating. This rating can be confusing; e.g., a 150 psig flange rating is actually good for about 230 psi design.

Flare: 1. A burner on a remote line used for disposal of hydrocarbons during clean-up, for emergency shut downs, and for disposal of small-volume waste streams of mixed gases that cannot easily or safely be separated. 2. A flame used to burn off unwanted natural gas; a “flare stack” is the steel structure on a processing facility from which gas is flared. 3. An open flame used to burn off unwanted natural gas. 4. To burn unwanted gas through a pipe or stack. 5. The flame from a flare; the pipe or the stack itself.

Flared: Gas disposed of by burning in flares usually at the production sites or at gas processing plants.

Flare Stack: The steel structure on an offshore rig or at a processing facility from which gas is flared.

Flare System: This is a piping network that runs through the plant to collect vents of gas so that they can be combusted at a safe location in the flare stack.

Flaring: Is the burning of a natural gas that cannot be processed or sold. Flaring disposes off gas, and it releases emissions into the atmosphere.

Flaring/Venting: The controlled burning (flare) or release (vent) of natural gas that cannot be processed

for sale or use because of technical or economic reasons.

Flashing: Vaporization of water or light ends as pressure is released during production or processing.

Flash Calculation: Determination of the compositions and quantities of liquid and vapor that co-exist in a mixture under equilibrium conditions.

Flash Chamber: A wide vessel in a vacuum flasher thermal cracking plant or similar operation into which a hot stream is introduced causing the lighter fractions of that stream to vaporize and leave by the top.

Flash Fire: The combustion of a flammable vapor and air mixture in which flame passes through that mixture at less than sonic velocity, such that negligible damaging overpressure is generated.

Flash Point: 1. The minimum temperature at which a liquid, under specific test condition gives off sufficient flammable vapor to ignite momentarily on the application of ignition source. 2. The lowest temperature at which any combustible liquid will give off sufficient vapor to form an inflammable mixture with air (i.e., that can be readily ignited). Flash points are used to specify the volatility of fuel oils, mostly for safety reasons. They are generally used as an indication of the fire and explosion potential of a product; ASTM D-56, D-92, D-93, D-134, D-1310. 3. Hold a flame over a cup of diesel fuel; it will start to burn at its 160°F (71°C) flash temperature. Gasoline’s flash point is below room temperature. Jet fuel is 110°F (43°C). The lighter the hydrocarbon, the lower the flash point.

Flash Tank: Container where the separation of gas and liquid phases is achieved after pressure reduction in flow fluid. Both phases appear when pressure is decreased as a consequence of the Joule-Thomson effect.

Flash Vapors: Vapors released from a stream of natural gas liquids as a result of an increase in temperature or a decrease in pressure.

Flash Zone: The section of a distillation/fractionating column containing the column feed nozzle(s). The column feed separates or “flashes” into liquid and vapor at it expands through the feed nozzle(s) and enters the column.

Flexicoking: A thermal cracking process which converts heavy hydrocarbons such as crude oil, oil sands bitumen, and distillation residues into light

hydrocarbons. Feedstocks can be any pumpable hydrocarbons including those containing high concentrations of sulfur and metals.

Flooding: 1. An excessive build-up of liquid in absorption columns or on the plate of a distillation column. It is due to high vapor flow rates up the column. In distillation columns, this is caused by high heating rates in the reboiler. 2. An all-inclusive term that is given to non-equilibrium behavior in a distillation/fractionating column because of larger flows of liquid and/or vapor than the column can process. Flooding can be caused by liquid backing up in the column, vapor blowing through the column and lifting the liquid off the trays, etc. All columns are designed to handle about 80% of the flow before flooding occurs. Sometimes flooding is caused by mechanical restrictions or damage to the internals in the column. The **flooding point** is a condition in a packed column such as an absorption column which receives a counter current flow of gas at the bottom and a liquid descending under gravity from the top where there is insufficient liquid hold-up in the packing for mass transfer to take place effectively. The liquid therefore descends to the bottom of the column without mass transfer. The rate of flow through the packing for effective mass transfer is controlled by the pressure drop across the packing material.

Flow: The movement of a fluid under the influence of an external force such as gravity or a pump.

Flowline: A pipeline that carries materials from one place to another. In the offshore industry, a flowline is a pipeline that carries oil on the seabed from a well to a riser. On a process flow diagram, the flowline is indicated by a line entering and leaving a vessel or unit operation. An arrow indicates the direction of flow.

Flow meter: A device used to measure the flow of process fluids. Flow meters are mainly classified into those that are intrusive and those that are non-intrusive to the flow of the fluid. Flow meters include differential pressure meters, positive displacement meters, mechanical, acoustic and electrically heated meters. The measurement of the flow of process fluids is essential not only for safe plant control but also for fiscal monitoring purposes. It is essential to select correctly the flow meter for a particular application, which requires a knowledge and comprehension of the nature of the fluid to be measured and an understanding of the operating principles of flow meters.

Flow rate: The movement of material per unit time. The material may be a gas, liquid or solid particulates in suspension or combination of all of these, and expressed on a mass, volumetric or molar basis. The volumetric flow of material moving through a pipe is the product of its average velocity and the cross-sectional area of the pipe.

Flow regime: The behavior of a combined gas and liquid flow through a duct, channel or pipe can take many forms, and there are descriptions used to define the possible flow patterns. Depending on the conditions of flow of the two phases, one phase is considered to be the continuous phase while the other is the discontinuous phase. An example is the flow of mist or fine dispersion of liquid droplets in a gas phase. The smaller the liquid droplets, the higher are the surface tension effects. Distortion of the discontinuous phase results in the shape to become non-spherical. Also, there is a tendency for the liquid phase to wet the wall of the pipe and for the gas phase to congregate at the center. An exception to this is in evaporation such as in refrigeration where nuclear boiling occurs on the pipe surface resulting in a vapor film or bubbles forming at the surface with a central core of liquid. The flow of fluids through pipes and over surfaces can be described as:

1. Steady flow in which flow parameters at any given point do not vary with time.
2. Unsteady flow in which flow parameters at any given point vary with time.
3. Laminar flow in which flow is generally considered to be smooth and streamline.
4. Turbulent flow in which flow is broken up into eddies and turbulence.
5. Transition flow, which is a condition lying between the laminar and turbulent flow regimes

Flow regime maps are charts representing the various flow patterns that are possible for two-phase gas-liquid flow in both horizontal and vertical pipes and tubes. There are many types of flow regime maps that have been developed. The simplest form of the map involves a plot of superficial velocities or flow rates for the two phases with the most widely used generalized flow regime map for horizontal flow as shown below:

The maps are populated with experimental data in which lines are drawn to represent the boundaries between the various flow regimes. These include dispersed, bubble or froth, wavy, annular, stratified, slug and plug flow. The boundaries between the various flow

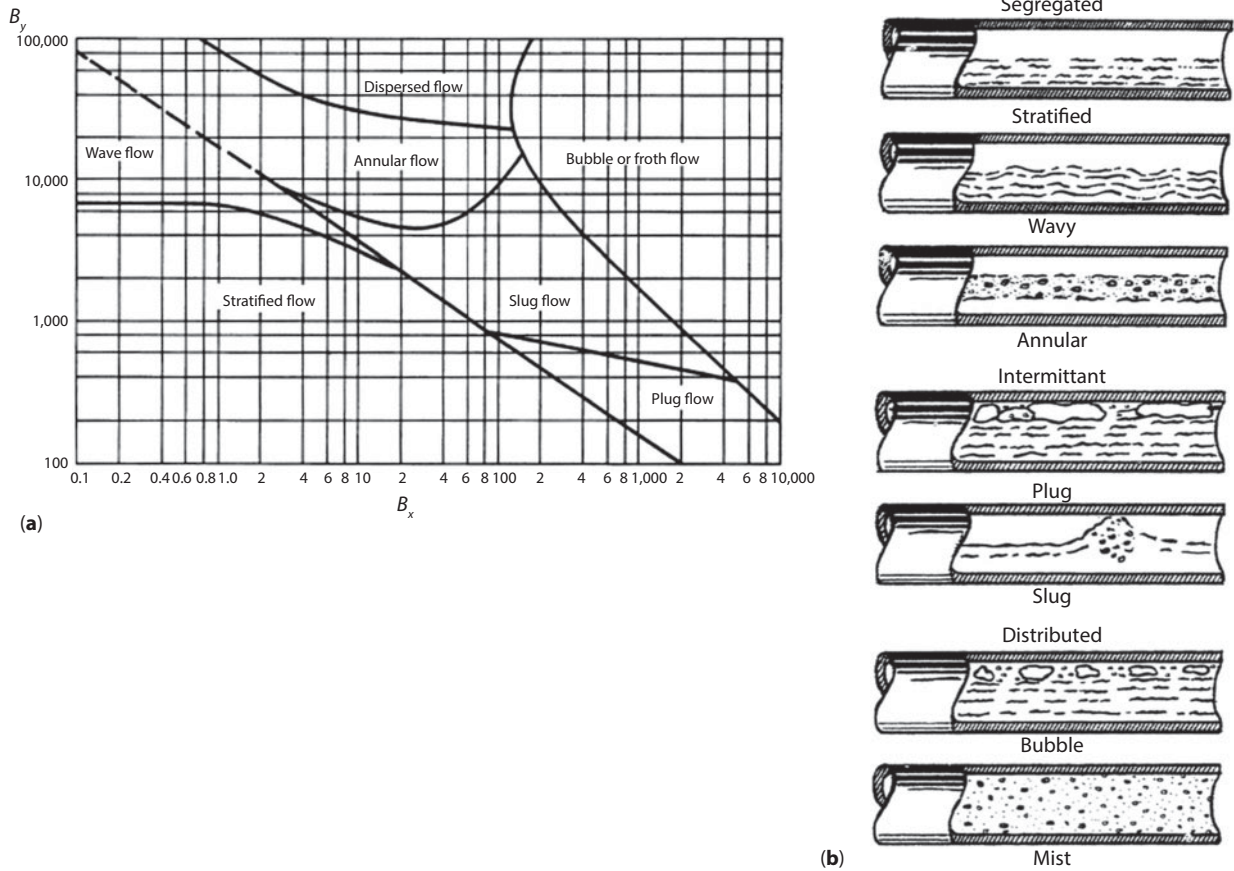


Figure 9 (a) Flow patterns for horizontal two-phase flow (Based on data from 1, 2, and 4 in. pipe by Baker, O., *Oil & Gas J.*, Nov. 10, p. 156, 1958.). (b) Representative forms of horizontal two-phase flow patterns as indicated in Figure 9a.

patterns are due to the regime becoming unstable as it approaches the boundary with the transition to another flow pattern. As with the transition between laminar and turbulent flow in a pipe, the transitions in a flow regime are unpredictable. The boundaries are therefore not distinct lines but loosely defined transition zones. A limitation of the maps is that they tend to be specific to a particular fluid and pipe. The seven types of flow regimes in order of increasing gas rate at constant liquid flow rate are given below (See Figure 9).

Bubble or Froth flow: Bubbles of gas are dispersed throughout the liquid and are characterized by bubbles of gas moving along the upper part of the pipe at approximately the same velocity as the liquid. This type of flow can be expected when the gas content is less than about 30% of the total (weight) volume flow rate. (Note: 30% gas by weight is over 99.9% by volume, normally.)

Plug flow: Alternate plugs of liquid and gas move along the upper part of the pipe and liquid moves along the bottom of the pipe.

Stratified flow: The liquid phase flows along the bottom of the pipe while the gas flows over a smooth liquid-gas interface.

Wave flow: Wave flow is similar to stratified flow except that the gas is moving at a higher velocity and the gas-liquid interface is distributed by waves moving in the direction of flow.

Slug flow: This pattern occurs when waves are picked up periodically by the more rapidly moving gas. These form frothy slugs that move along the pipeline at a much higher velocity than the average liquid velocity. This type of flow causes severe and in most cases, dangerous vibrations in equipment because of the high velocity slugs against fittings.

Annular flow: In annular flow, liquid forms around the inside wall of the pipe and gas flows at a high velocity through the central core.

Dispersed, Spray or Mist flow: Here, all of the liquid is entrained as fine droplets by the gas phase. This type

of flow can be expected when the gas content is more than roughly 30% of the total weight flow rate. Some overhead condenser and reboiler-return lines have dispersed flow.

Flowsheet: A schematic diagram or representation of a process illustrating the layout of process units and their functions linked together by interconnecting process streams. The development of a flowsheet involves the process synthesis, analysis and optimization. The heat and material balances are solved using thermodynamic properties and models. An economic analysis is also completed as well as a safety and environmental impact assessment. The choice of equipment and their interconnectivity are optimized along with the choice of operating parameters such as temperature, pressure and flows. Steady-state flowsheet computer software packages are frequently used to develop flowsheets.

Flue: Passage through which flue gases pass from a combustion chamber to the outside atmosphere.

Flue Gas: 1. A mixture of gases produced as a result of combustion that emerge from a stack or chimney. The gases contain smoke, particulates, carbon dioxide, water vapor, unburnt oxygen, nitrogen, etc. An Orsat analysis is a reliable device to determine the composition of the flue gas and the efficiency of combustion although it has been replaced by other techniques. 2. Gas from the various furnaces going up to the flue (stack).

Fluid Catalytic Cracking (FCC): A thermal process in which the oil is cracked in the presence of finely divided catalyst which is maintained in an aerated or fluidized state by the oil vapors. The powder or fluid catalyst is continuously circulated between the reactor and the regenerator, using air, oil vapor and steam as the conveying media. The most commonly used catalytic cracking process. The catalyst is a fine powder that is designed to form a fluidized bed in the reactor and regenerator.

Fluid Coking: 1. A coking process in which the feed is preheated and sprayed into a reactor where it contacts a hot fluidized bed of coke returning from a burner vessel. The hot oil products are stripped from the coke which is circulated back to the burner vessel. Coke not returned to the reactor from the burner vessel is withdrawn as a coke product. 2. A thermal cracking process utilizing the fluidized-solids technique to remove carbon (coke) for continuous conversion of heavy, low-grade oils into lighter products.

Fossil Fuels: Fuels formed by natural processes such as anaerobic decomposition of buried dead organisms. The age of the organisms and their resulting fossil fuels is typically millions of years, and sometimes exceeds 650 million years. Fossil fuels contain high percentage of carbon and include coal, petroleum and natural gas. Other more commonly used derivatives of fossil fuels are kerosene, and propane. They range from volatile materials with low carbon: hydrogen ratios like methane, to liquid petroleum to nonvolatile materials composed of almost pure carbon, like anthracite coal. Methane can be found in hydrocarbon fields, alone, associated with oil, or in the form of methane clathrates (See Figure 10).

Georg Agricola in 1556 first introduced the theory that fossil fuels were formed from the fossilized remains of dead plants by exposure to heat and pressure in the Earth's crust over millions of years. The theory was later expounded by Mikhail Lomonosov in the 18th century. Coal is one of the fossil fuels (See Figure 10).

The use of fossil fuels raises serious environmental concerns. The burning of fossil fuels produces around 21.3 billion tonnes (21.3 gigatonnes) of carbon dioxide (CO₂) per year, but it is estimated that natural processes can only absorb about half of that amount, so there is a net increase of 10.65 billion tonnes of atmospheric carbon dioxide per year (one tonne of atmospheric carbon is equivalent to 44/12 or 3.7 tonnes of carbon dioxide). Carbon dioxide is one of the greenhouse gases that enhances the radiative forcing and contributes to global warming, causing the average surface temperature of the Earth to rise with major adverse climatic effects. A global movement towards the generation of renewable energy is therefore essential to help reduce global greenhouse gas emissions.

Ratio of gross domestic product to kilograms of fossil fuel carbon consumed, for the world's 20 largest economies. The two countries with the highest GDP per



Figure 10 Coal.

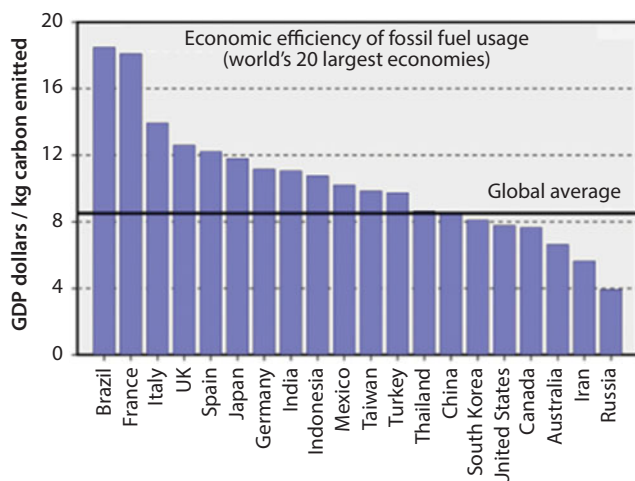


Figure 11 Economic efficiency of fossil fuel usage.

kilogram carbon ratios, Brazil and France, produce large amounts of hydroelectric and nuclear power, respectively (See Figure 11).

Fractionation: The general name given to a process for separating mixtures of hydrocarbons or other chemicals into separate streams or cuts or fractions.

Free Carbon: The organic materials in tars which are insoluble in carbon disulfide.

Free Energy of Formation: the change in free energy when a compound is formed from its elements with each substance in its standard state at 77°F (25°C). The heat of reaction at 25°C may be calculated by subtracting the sum of the free energies of formation of the reactants from the sum of the free energies of formation of the products.

Free Water: Condensed water that exits as a separate liquid phase. Most refinery distillation columns are designed such that free water will not be present, since it can result in column upsets and promote corrosion of the metal in the column.

Freeze Point: 1. The temperature at which the hydrocarbon liquid solidifies at atmospheric pressure. It's an important property for kerosene and jet fuels, because of the very low temperatures encountered at high altitudes in jet planes. One of the standard test methods for the freeze point is ASTM D4790. 2. The temperature at which a chilled petroleum product becomes solid and will no longer pour when a sample tube is tipped. Freeze point is a laboratory test. 3. The temperature at which crystals first appear as a liquid is

cooled, which is especially important in aviation fuels, diesel and furnace oil.

Front-End Engineering and Design (FEED)

Contract: 1. A legal agreement setting out the terms for all activities required to define the design of a facility to a level of definition necessary for the starting point an EPC contract. 2. Generally, the second contracting phase for the development of the export facilities in the LNG chain that provides greater definition than the prior conceptual design phase. In an LNG project, the single most important function of the FEED contract is to provide the maximum possible definition for the work ultimately to be performed by the engineering, procurement, and construction (EPC) contractor. 3. A study used to analyze the various technical options for new field developments with the objective to define the facilities required. 4. The stage of design between concept evaluation and detailed design during which the chosen concept is developed such that most key decisions can be taken. Output of FEED includes estimate of total installed cost and schedule. *See also Engineering, procurement and construction contract.*

Fuel Gas: 1. A process stream internal to a facility that is used to provide energy for operating the facility. 2. Gas used as fuel in a liquefaction plant. It typically involves processing waste streams to LNG that are not profitable. It is used in gas turbines, boilers and reaction furnaces.

Fuel Oil: Usually residual fuel but sometimes distillate fuel.

Fuel Oil Equivalent (FOE): The heating value of a standard barrel of fuel oil, equal to 6.05×10^6 Btu (LHV). On a yield chart, dry gas and refinery fuel gas are usually expressed in FOE barrels.

Furnace Oil: A distillate fuel made of cracked and straight run light gas oils primarily for domestic heating because of its ease of handling and storing.

FVT: The final vapor temperature of a cut. Boiling ranges expressed in this manner are usually on a crude assay, true boiling point basis.

Gas/Liquid chromatography (GC, GLC): Equipment used to determine the composition of a sample in the laboratory.

Gap: Gas is usually based on ASTM 86 distillation temperatures and is defined as the 5% distilled temperature of a distillation column product minus the 95%

distilled temperature of the next higher product in the column. When the difference is positive, the difference is called a gap. When the difference is negative, the difference is sometimes called an overlap. The gap or overlap is a measure of the sharpness of the separation between adjacent products in a distillation column.

Gas Cap: An accumulation of natural gas at the top of a crude oil reservoir. The gas cap often provides the pressure to rapidly evacuate the crude oil from the reservoir.

Gasket: This is the softer material that is pressed between flanges to keep the fluid from leaking. Using the wrong gasket is a common cause of fires in process plants. Gaskets have different temperature and pressure ratings.

Gas Oil: 1. Any distillate stream having molecular weights and boiling points higher than heavy naphtha > 400°F (> 205°C). The name gas oil probably traces its roots to “gasoline” bearing oil in the early days of refining. Early refiners used thermal cracking processes to produce more motor gasoline (MOG) from gas oil stocks. 2. The term is used for petroleum stocks with boiling ranges between approximately 650–1100°F (344–594 °C). Unreacted gas oils produced by distilling crude oil in crude and vacuum columns. Cracked gas oils are produced in refinery reaction processes, such as thermal and catalytic cracking, coking, visbreaking and hydrocracking.

Gasoline: 1. A light petroleum product in the range of 80–400°F (27–204°C) for use in spark-ignition internal combustion engines. 2. An all-inclusive name for petroleum stocks that are used as fuel for internal combustion engines. Retail gasoline is a blend of several refinery gasolines and must meet specifications of octane, Reid vapor pressure, distilling boiling range, sulfur content, and so on. Additives such as ethers or alcohols are used to improve the octane for the blended product.

Gasoline Blending Components: Naphthas which will be used for blending or compounding into finished aviation or motor gasoline (e.g., straight-run gasoline, alkylate, reformat benzene, toluene, and xylenes). Excludes oxygenates (alcohols, ethers), butane, and natural gasoline.

Gas sweetening: A process used to remove hydrogen sulfide and mercaptans from natural gas. Commonly used in petroleum refineries, the gas treatment uses amine solution such as monoethanolamine. The

process uses an absorber unit and a regenerator. The amine solution flows down the scrubber and absorbs the hydrogen sulfide as well as carbon dioxide from the upflowing gases. The regenerator is used to strip the amine solution of the gases for reuse. It is known as gas sweetening as the foul smell is removed from the gas.

Gas Treating: Amine treating of light gases to remove such impurities as H₂S and CO₂. Molecular sieves are also used to concentrated hydrogen streams by removing inerts and light hydrocarbon contaminants.

Gas Turbine: An engine that uses internal combustion to convert the chemical energy of a fuel into mechanical energy and electrical energy. It uses air, which is compressed by a rotary compressor driven by the turbine, and fed into a combustion chamber where it is mixed with the fuel, such as kerosene. The air and fuel are burnt under constant pressure conditions. The combustion gases are expanded through the turbine causing the blades on the shaft to rotate. This is then converted to electrical energy. Gas turbines are used in the process industries and on offshore gas platforms for electrical generation.

Grain: A unit of mass where one pound is equivalent to 7000 grains and a specification of 0.25 grain of H₂S per 100 scf is equivalent to an H₂S concentration of 4.0 ppmv.

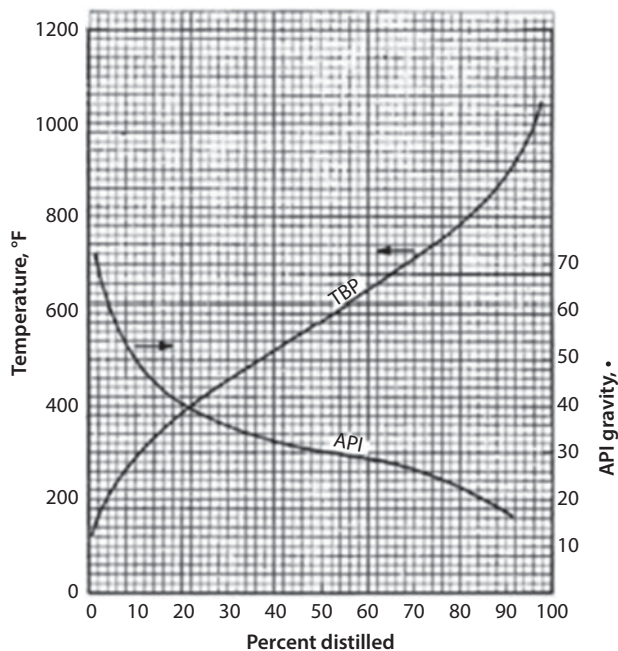


Figure 12 TBP and gravity – mid percent curves.

Gravity: The specific gravity (Sp.Gr.) of a stream, often expressed as API Gravity by petroleum refiners. The basis is always the density of water.

Gravity Curve: The gravity of the material distilled from a petroleum stock in a laboratory still. The gravity curve is plotted against the percent distilled for the stock. Gravity curves are most commonly reported for true boiling point distillation (See Figure 12).

Greenhouse Gas (GHG): A greenhouse gas is a gas in an atmosphere that absorbs and emits radiation within the thermal infrared range. This process is the fundamental cause of the greenhouse effect. The primary greenhouse gases in Earth's atmosphere are water vapor, carbon dioxide, methane, nitrous oxide and ozone. Without greenhouse gases, the average temperature of Earth's surface would be about 15°C (27°F) colder than the present average of 14°C (57°F).

Gross Heating Value: Is the total energy transferred as heat in an ideal combustion reaction at a standard temperature and pressure in which all water formed appears as liquid. The gross heating is an ideal gas property in a hypothetical state (the water cannot all condense to liquid because some of the water would saturate the CO₂ in the products).

Gross Heating Value of Fuels (GHV): The heat produced by complete oxidation of material of 60°F (25°C) to carbon dioxide and liquid water at 60°F (25°C).

Gross Input to Atmospheric Crude Oil Distillation Units: Total inputs to atmospheric crude oil distillation units. Includes all crude oil, lease condensate, natural gas plant liquids, unfinished oils. Liquefied refinery gases, slop oils, and other liquid hydrocarbons produced from oil sands, gilsonite and oil shale.

Gum: A complex sticky substance that forms by the oxidation of gasoline especially those stored over a long period of time. Gum fouls car engines especially the fuel injection ports.

Harm: Physical injury or damage to the health of people, either directly or indirectly, as a result of damage to property or to the environment.

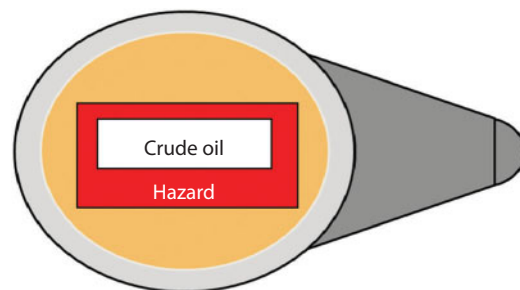
Hazard: 1. A condition or object that has the potential to cause harm. 2. An unsafe condition, which if not eliminated or controlled may cause injury, illness or death. 3. A physical or chemical characteristic that has the potential for causing harm to people, the environment, or property. Examples of hazards:

- *Combustible/Flammable substance. E.g., Ethylene is flammable*
- *Corrosive. E.g., Sulfuric acid is extremely corrosive to the skin.*
- *Explosive substance. E.g., Acrylic acid can polymerize, releasing large amounts of heat.*
- *Toxic fumes. E.g., Chlorine is toxic by inhalation.*
- *Substances kept at high pressure in containment (e.g., a vessel, tank)*
- *Objects or material with a high or low temperature.*
- *Radiation from heat source.*
- *Ionizing radiation source.*
- *Energy release during decomposition of a substance. E.g., Steam confined in a drum at 600 psig contains a significant amount of potential energy (See Figure 13).*

Hazard Analysis: Is the first step in a process used to assess risk. The result of a hazard analysis is the identification of different type of hazards.

It is assigned a classification, based on the worst-case severity of the end condition. Risk is the combination of probability and severity. Preliminary risk levels can be provided in the hazard analysis. The validation, more precise prediction (verification) and acceptance of risk is determined in the risk assessment (analysis). The main goal of both is to provide the best selection of means of controlling or eliminating the risk.

Hazard Communication: Employees' "right-to-know" legislation requires the employers to inform employees (pretreatment inspectors) of the possible health effects resulting from contact with hazardous substances. At locations where this legislation is in force, employers must provide employees with information regarding any hazardous substances, which they might be exposed to under normal work conditions or reasonably foreseeable emergency conditions



Consider pressure, temperature, composition, quantity, etc. into account.

Figure 13 A hazard.

resulting from workplace conditions. OSHA's Hazard Communication Standard (HCS) (Title 29 CFR Part 1910.2100) is the federal regulation and state statutes are called Workers' Right-to-Know Laws.

Hazard Communication Program: A written plan to manage the hazards associated with the use of chemicals in the workplace.

Hazardous Chemical: A substance that may harm the worker either physically (e.g., fire, explosion) or chemically (e.g., toxic, corrosive).

Hazardous Events: Hazardous event is defined as hazardous situation which results in harm. Each identified hazard could give a number of different hazardous events. For each identified hazardous event, it should also be described which factors contributed to it.

E.g., the hazard combustible substance could give the following hazardous events:

- Pool fire outside a tank, due to leakage, when an ignition source is present.
- Flash fire inside a tank when an ignition source is present.
- Factors that could contribute to the leakage in the tank could for instance be:
 - *Bad connection joint.*
 - *Gasket damage.*
 - *Tube damage.*
 - *Pipe damage.*

Hazardous Situation: Circumstance in which a person is exposed to hazards.

HAZID/HAZOP: 1. HAZard Identification/HAZard and Operability analysis systematic design review methods to identify and address hazards to ensure that the necessary safety measures to eliminate or mitigate hazards are incorporated in the design and operation of the unit. 2. A qualitative process risk analysis tool used to identify hazards and evaluate if suitable protective arrangements are in place. If the process were not to perform as intended, and unexpected consequences were to result.

HCGO: Heavy coker gas oil.

HCO: Heavy FCC cycle gas oil. *See Heavy Cycle Oil.*

Heart cut recycle: That unconverted portion of the catalytically cracked material which is recycled to the catalytic cracker. This recycle is usually in the boiling

range of the feed, and by definition, contains no bottoms. Recycle allows less severed operation and suppresses the further cracking of desirable products.

Heat Balance: *See energy balance.*

Heat Exchangers: A pressure vessel for transferring heat from one liquid or vapor stream to another. A typical heat exchanger consists of a cylindrical vessel and nozzles through which one stream can flow and a set of pipes or tubes in series in the cylinder through which the other can flow. Heat transfer mechanisms are conduction and convection. *See also Shell & Tube Heat Exchanger.*

Heat Flux: The rate of heat transfer per unit area normal to the direction of heat flow. It is the total heat transmitted by radiation, conduction and convection.

Heat Pump: Thermodynamic heating/refrigerating system to transfer heat. The condenser and evaporator may change roles to transfer heat in either direction.

Heat Rate: The measure of efficiency in converting input fuel to electricity. Heat rate is expressed as the number of Btu of fuel (e.g., natural gas) per kilowatt hour (Btu/kWh). Heat rate for power plants depends on the individual plant design, its operating conditions, and its level of electric power output. The lower the heat rate, the more efficient is the plant.

Heat Recovery: Heat utilized that would otherwise be wasted from a heating system.

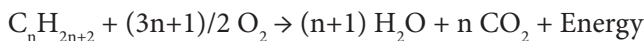
Heat Transfer Coefficient: Coefficient describing the total resistance to heat loss from a producing pipe to its surroundings. Includes heat loss by conduction, convection and radiation.

Heating Oil: Any distillate or residual fuel. 1. Oil used for residential heating. 2. Trade term for the group of distillate fuel oils used in heating homes and buildings as distinguished from residual fuel oils used in heating and power installations. Both are burner fuel oils.

Heating Value: 1. The average number of British thermal units per cubic foot of natural gas as determined from tests of fuel samples. 2. The amount of heat produced from the complete combustion of a unit quantity of fuel. 3. The amount of energy or heat that is generated when a hydrocarbon is burned (chemically combined with oxygen). 4. Energy released in the complete combustion of a unit of mass, matter or volume

of a fuel in a stoichiometric mixture with air. 5. The amount of heat produced by the complete combustion of a unit quantity of fuel.

Heat of Combustion: The amount of heat released in burning completely an amount of substance is its heat of combustion. The general formula for the combustion of a hydrocarbon compound is:



Heat of Reaction: The heat release of heat absorbed when a chemical reaction takes place. The heat of reaction may be computed from the free energies of formation for the reacting components and the resultant products at the standard temperature of 77°F (25°C).

Heat of Vaporization: The amount of heat energy required to transform an amount of a substance from the liquid phase to the gas phase.

Heavy Crude: Crude oil of 20° API gravity or less; often very thick and viscous.

Heavy Cycle Oil (HCO): Gas oil produced in an FCC operation that boils in the approximate TBP range of 400–1000°F (205–358°C). Heavy cycle oil is not generally withdrawn as a product, but it is recycled back to the reactor for further cracking to improve the overall conversion of the process.

Heavy Ends: The highest boiling portion of a gasoline or other petroleum oil. The end point as determined by the distillate test reflects the amount and character of the heavy ends present in a gasoline.

Heavy Gas Oil: Petroleum distillates with an approximate boiling range from 651°F to 1000°F (344°C to 538°C).

Heavy Key: A distributed component in a distillation section that is recovered in the (bottom) heavy product, with a small, specified amount leaving in the top product.

Heavy Oil: Lower gravity, often higher viscosity oils. Normally less than 28° API gravity.

Hempel distillation: U.S. Bureau of Mines (now Department of Energy, DOE). Routine method of distillation. Results are frequently used interchangeably with TBP distillation.

Heptane (nC₇H₁₆): Normal heptane is a straight chain alkane hydrocarbon with the chemical formula H₃C(CH₂)₅CH₃ or C₇H₁₆. Heptane (and its many

isomers) is widely applied in laboratories as a totally non-polar solvent. As a liquid, it is ideal for transport and storage. Heptane is commercially available as mixed isomers for use in paints and coatings, as pure n- heptane for research and development and pharmaceutical manufacturing and as a minor component of gasoline.

n - heptane is defined as the zero point of the octane rating scale. It is undesirable in gasoline because it burns explosively, causing engine knocking, as opposed to branched-chain octane isomers, which burn more slowly and give better performance. When used as a fuel component in antiknock test engines, a 100% heptane fuel is the zero point of the octane rating scale (the 100 point is 100% iso-octane). Octane number equates to the antiknock qualities of a comparison mixture of heptane and isooctane which is expressed as the percentage of isooctane in heptane and is listed in pumps for gasoline dispensed in the U.S. and internationally.

HF Alkylation: alkylation using hydrofluoric acid as a catalyst.

High Pressure (HP): A processing unit operating at either equal to or greater than 225 psig measured at the outlet separator.

High Temperature Simulated Distillation (HTSD): Laboratory test designed for petroleum stocks boiling up to 1382°F (750°C).

HSR: Heavy Straight-Run. Usually naphtha side stream from the atmospheric distillation tower.

HVGO: Heavy vacuum gas oil. A side stream from the vacuum distillation tower.

Hydrocarbon: Any organic compound that is comprised of hydrogen and carbon atoms, including crude oil, natural gas and coal.

Hydrocrackate: The gasoline range product from a hydrocracker.

Hydrocracking: 1. A process in which high or heavy gas oils or residue hydrocarbons are mixed with hydrogen under high pressure and temperature and in the presence of a catalyst to produce light oils. 2. A refining process in which a heavy oil fraction or wax is treated with hydrogen over a catalyst under relatively high pressure and temperature to give products of lower molecular mass.

Hydrocracked Naphtha: A high-quality blending stream obtained when high boiling cracked distillates undergo a combination of processes like cracking, hydrogenation and reforming in the presence of a catalyst and hydrogen.

Hydrocyclone: A cone-shaped device for separating fluids and the solids dispersed in fluids.

Hydrodesulfurization: A process in which sulfur is removed from the molecules in a refinery stream by reacting it with hydrogen in the presence of a catalyst.

Hydrodesulfurizing: A process for combining hydrogen with the sulfur in refinery petroleum streams to make hydrogen sulfide, which is removed from the oil as a gas.

Hydrogen: The lightest of all gases, the element (hydrogen) occurs chiefly in combination with oxygen in water. It also exists in acids, bases, alcohols, petroleum and other hydrocarbons.

Hydrogen Consumption: The amount of hydrogen that is consumed in a hydrocracking or hydrotreating process, usually expressed on per unit of feed basis. Hydrogen may be consumed in chemical reactions and dissolved and lost from the process in the liquid hydrocarbon products.

Hydrogen Embrittlement: A corrosion mechanism in which atomic hydrogen enters between the grains of the steel and causes the steel to become very brittle.

Hydrogen-Induced Cracking: Stepwise internal cracks that connect hydrogen blisters.

Hydrogen Sulfide: 1. "Rotten egg gas", H_2S . It is responsible for the distinctive odor of Rotorua. 2. An objectionable impurity present in some natural gas and crude oils and formed during the refining of sulfur-containing oils. It is removed from products by various treatment methods at the refining. 3. Hydrogen sulfide is a gas with a rotten egg odor. This gas is produced under anaerobic conditions. Hydrogen sulfide gas is particularly dangerous because it dulls the sense of smell so that one does not notice it after one has been around it for a while. In high concentrations, hydrogen sulfide gas is only noticeable for a very short time before it dulls the sense of smell. The gas is very poisonous to the respiratory system, explosive, flammable, colorless and heavier than air. 4. A toxic, corrosive, colorless gas with the characteristic smell of rotten eggs in low concentration. An acid gas.

Hydrogen Sulfide Cracking: Minute cracking just under a metal's surface caused by exposure to hydrogen sulfide gas.

Hydrogenation: 1. Filling in with hydrogen the "free" places around the double bonds in an unsaturated hydrocarbon molecule. 2. A refinery process in which hydrogen is added to the molecules of unsaturated hydrocarbon fractions.

Hydrofining: A process of treating petroleum fractions and unfinished oils in the presence of catalysts and substantial quantities of hydrogen to upgrade their quality.

Hydroforming: A process in which naphtha is passed over a solid catalyst at elevated temperature and moderate pressures in the presence of added hydrogen to obtain high-octane motor fuels.

Hydroskimming Refinery: A topping refinery with a catalytic reformer.

Hydrostatic Pressure: Pressure created by a column of fluid that expresses uniform pressure in all directions at a specific depth and fluid composition above the measurement point.

Hydrotreating: 1. A refinery process to remove sulfur and nitrogen from crude oil and other feedstocks. 2. This is a term for a process by which product streams may be purified and otherwise be brought up to marketing specifications as to odor, color, stability, etc. 3. A process in which a hydrocarbon is subjected to heat and pressure in the presence of a catalyst to remove sulfur and other contaminants such as nitrogen and metals and in which some hydrogenation can take place. Hydrotreating for the removal of sulfur is the major treating process in refineries. Cracked streams could be saturated and stabilized by converting olefins, albeit under more severe treating conditions. The process involves hydrogen under suitable temperature, pressure and a catalyst.

Hyperforming: A catalytic hydrogenation process used for improving the octane number of naphtha by the removal of sulfur and nitrogen compounds.

H_2 /Oil Ratio and Recycle Gas Rate: The H_2 /oil ratio in standard cubic feet (scf) per barrel (bbl) is determined by

$$\frac{H_2}{oil} = \frac{\text{total hydrogen gas to the reactor, scf/day}}{\text{total feed to the reactor, bbl/day}} [=] \frac{\text{scf}}{\text{bbl}}$$

H_2 /oil ratio in m^3 /bbl is obtained by multiplying H_2 /oil ratio in (scf/bbl) by a conversion factor 0.028317. A molar H_2 /oil ratio can be calculated from the volumetric H_2 /oil ratio by the following equation:

$$\frac{\text{molar } H_2}{\text{oil}} = 1.78093 \times 10^{-7} \left(\frac{H_2 \text{ scf}}{\text{oil bbl}} \right) \frac{MW_{\text{oil}}}{MW_{H_2}} \frac{\rho_{H_2}}{\rho_{\text{oil}}}$$

where MW_{oil} and MW_{H_2} are the molecular weights of the oil to be hydrotreated and of hydrogen respectively, and ρ_{oil} and ρ_{H_2} are the densities of the oil and hydrogen (ρ_{H_2} at 15°C and 1 atm. is 0.0898 kg/cm^3).

Hypothetical State: Is defined as a fluid in a state that cannot actually exist, e.g., methane as a liquid at 60°F and 14.696 psia. Methane cannot be in its liquid phase at this temperature and pressure, but such a state when defined, can be used in calculations.

Identification and Structural Group Analysis: The crude oil is a complex mixture of saturated hydrocarbons, saturated hetero-compounds, and aromatic hydrocarbons, olefinic hydrocarbons and aromatic hetero-compounds. With the advancement of the instrumental analysis techniques like chromatography and spectroscopic methods, now it has been possible to study in depth, the identification and structural group analysis. Some of the major analytical instruments used are gas chromatography, ion exchange chromatography, simulated distillation by gas chromatography, absorption chromatography, gel permeation chromatography, high-performance liquid chromatography and supercritical fluid chromatography. The application of spectroscopy, mass spectroscopy, electron spin resonance, X-ray diffraction, inductively coupled plasma emission spectroscopy, X-ray absorption spectroscopy and atomic absorption spectrophotometer.

Initial boiling point (IBP): Initial boiling point of a cut, usually on an ASTM basis. The lowest temperature at which a petroleum product will begin to boil. The boiling temperature in a laboratory still at which the first drop of distilled liquid is condensed. The initial boiling point may be higher than the boiling point for light components in the sample that are not condensed by the apparatus.

Ignition: The process of starting a combustion process through the input of energy. Ignition occurs when the temperature of a substance is raised to the point at which its molecules will react spontaneously with an oxidizer and combustion occurs.

Ignition Quality: Ignition quality is very important in the case of high-speed automotive diesel engines. The diesel engine knock, engine noise, smoke, gaseous emissions and so on, all depend upon this factor. Ignition quality is measured in terms of cetane number using an ASTM standard test engine. The test method designated as D613 comprises a single-cylinder engine with a variable compression ratio combustion pre-chamber.

Incident: See *Accident*

Independent Protection Layer (IPL): Protection measures that reduce the level of risk of a serious event to 100 times, which have a highly degree of availability (greater than 0.99) or have specificity, independence, dependability and auditability.

Inerting: The process of removing an oxidizer (usually air or oxygen) to prevent a combustion process from occurring, normally accomplished by purging.

Inflammable: Identical meaning as flammable, however the prefix "in" indicates a negative in many words and can cause confusion, therefore the use of flammable is preferred over inflammable.

Inherently Safer: 1. A chemical process is inherently safer if it reduces or eliminates the hazards associated with materials and operations used in the process, and this reduction or elimination is permanent and inseparable. 2. An essential character of a process, system or equipment that makes it without or very low in hazard or risk. Inherent safety is a way of looking at processes in order to achieve this. There are four main keywords:

- *Minimize (Intensification):* Reduce stocks of hazardous chemicals.
- *Substitute:* Replace hazardous chemicals with less hazardous ones.
- *Moderate (Attenuation):* Reduce the energy of the system – lower pressures and temperatures or adding stabilizing additives generally make for lower hazards.
- *Simplify:* Make the plant and process simpler to design, build and operate, hence less prone to equipment control and human failings.

Note: The principles of inherent safety are applied at conceptual design stage to the proposed process chemistry. In certain instances, these hazards cannot be avoided; they are basic properties of the materials and the conditions of usage. The inherently safer approach is to

reduce the hazard by reducing the quantity of hazardous material, or energy or by completely eliminating the hazardous agent.

Inherently Safer Design: Is a fundamentally different way of thinking about the design of chemical processes and plants. It focuses on the elimination or reduction of the hazards, rather than on management and control. This approach should result in safer and more robust processes, and it is likely that these inherently safer processes will also be more economical in due course.

Instrument: Apparatus used in performing an action (typically found in instrumented systems).

Note: Instrumented systems in the process sector typically composed of sensors (e.g., pressure, flow, temperature transmitters), logic solvers or control systems (e.g., programmable controllers, distributed control systems), and final elements (e.g., control valves). In special cases, instrumented systems can be safety instrumented systems.

Internal Combustion Engine (ICE): Is a heat engine where the combustion of a fuel occurs with an oxidizer (usually air) in a combustion chamber that is an integral part of the working fluid flow circuit. In an internal combustion engine, the expansion of the high-temperature and high-pressure gases produced by combustion apply direct force to some component of the engine. The force is applied typically to pistons, turbine blades or a nozzle. This force moves the component over a distance transforming chemical energy into useful mechanical energy (See Figure 14).

C	Crankshaft
E	Exhaust camshaft
I	Inlet camshaft

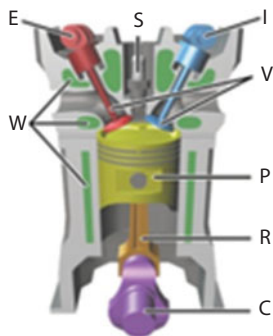


Figure 14 Diagram of a cylinder as found in 4-stroke gasoline engines.

P	Piston
R	Connecting rod
S	Spark plug
V	Valves. Red: exhaust, blue: intake
W	Cooling water jacket
	Gray structure: Engine block.

Intrinsically Safe (IS): A circuit or device in which any spark or thermal effect is incapable of causing ignition of a mixture of flammable or combustible material in air under prescribed test conditions.

IPTBE: Isopropyl tertiary butyl ether. An oxygenate used in motor fuels.

Isocracking: A hydrocracking process for the conversion of hydrocarbons to more valuable lower boiling products by operation at relatively lower temperatures and pressures in the presence of hydrogen and catalyst.

Isomerase: The product of an isomerization process.

Isomerization: 1. A refining process, which alters the fundamental arrangement of atoms in the molecule without adding or removing anything from the original material. Used to convert normal butane into isobutane (iC_4H_{10}), an alkylation process feedstock, and normal pentane and hexane into isopentane (iC_5H_{12}) and isohexane (iC_6H_{14}) high-octane gasoline components. 2. The rearrangement of straight-chain hydrocarbon molecules to form branched-chain products. Pentanes and hexanes, which are difficult to reform are isomerized using precious metal catalysts to form gasoline blending components of fairly high octane value. Normal butane may be isomerized to provide a portion of the isobutene feed needed for alkylation processes. The objective of isomerization is to convert low-octane n-paraffins to high-octane i-paraffins by using a chloride-promoted fixed bed reactor. 3. Isomerization is the process by which one molecule is transformed into another molecule that has exactly the same atoms, but the atoms are rearranged. In some molecules and under some conditions, isomerization occurs spontaneously. Many isomers are equal or roughly equal in bond energy, and so exist in roughly equal amounts, provided that they can interconvert relatively freely, that is the energy barrier between the two isomers is not too high. When the isomerization occurs intermolecularly, it is considered a rearrangement reaction.

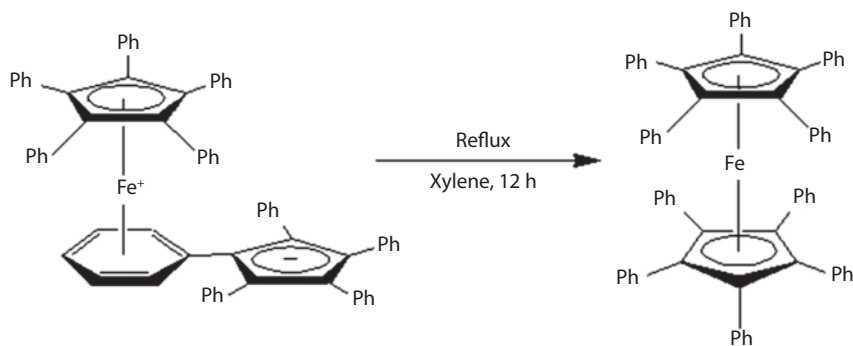


Figure 15

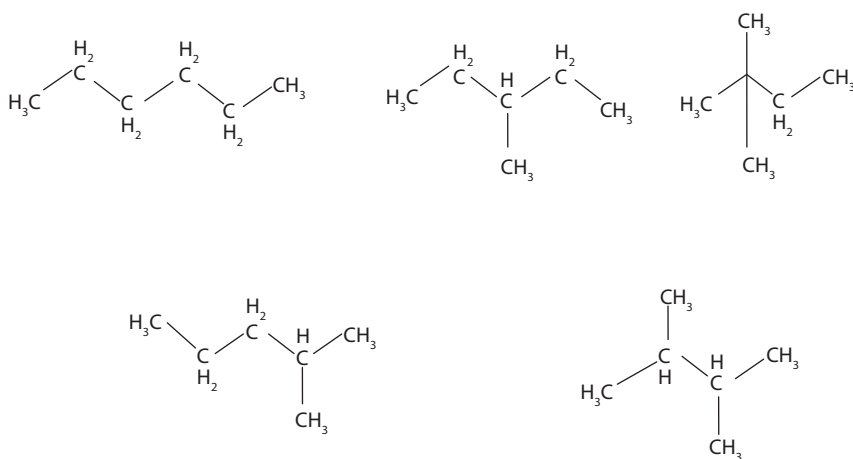


Figure 16

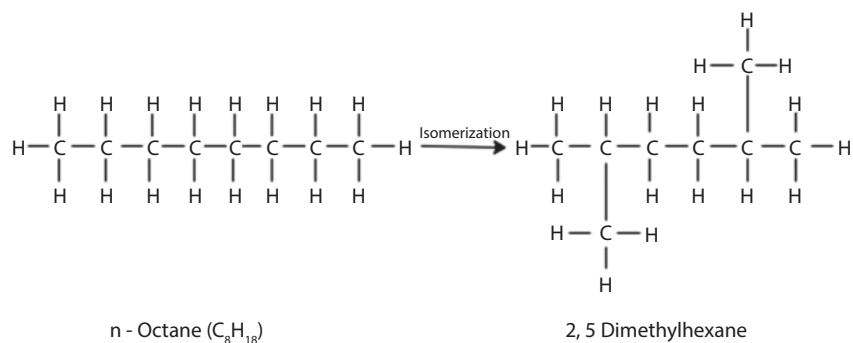


Figure 17

An example of an organometallic isomerization is the production of decaphenylferrocene, $[(\eta^5-C_5Ph_5)_2Fe]$ from its linkage isomer.

Isomers: Two compounds composed of identical atoms, but with different structures/configurations giving different physical properties. For example,

hexane (C_6H_{14}) could be n-hexane, 2- methyl pentane, 3- methyl pentane, 2, 3-dimethyl butane, and 2, 2- dimethylbutane.

A simple example of isomerism is given by propanol. It has the formula C_3H_8O (or C_3H_7OH) and occurs as two isomers: propanol-1 - ol (n-propyl alcohol; II) and propanol- 2- ol (isopropyl alcohol; III)

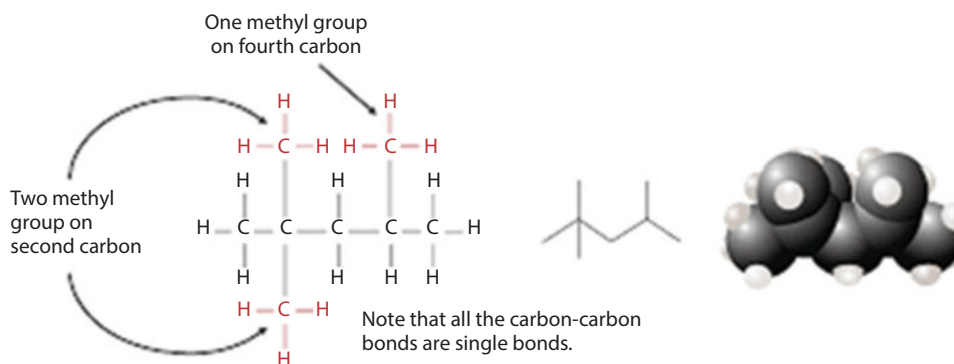


Figure 18

Note that the position of the oxygen atom differs between the two: It is attached to an end carbon in the first isomer, and to the center carbon in the second.

Isomerization of n-Octane to 2, 5 Dimethylhexane (See Figures 15, 16 and 17)

Isooctane - 2, 2, 4 - Trimethylpentane: Also known as isooctane or iso-octane is an organic compound with the structure formula $(\text{CH}_3)_3\text{CCH}_2\text{CH}(\text{CH}_3)_2$

It is one of several isomers of octane (C_8H_{18}). Engine knocking is an unwanted process that can occur during combustion in internal combustion engines.

Graham Edgar in 1926 added different amounts of n- heptane and 2,2,4 - trimethylpentane to gasoline, and discovered that the knocking stopped when 2,2,4 trimethylpentane was added. Test motors, using 2,2,4 trimethylpentane gave a certain performance which was standardized as 100 octane. The same test motors, run in the same fashion, using heptane gave a performance which was standardized as 0 octane. All other compounds and blends of components then were graded against these two standards and assigned octane numbers. 2,2,4 trimethylpentane is the liquid used with normal heptanes ($n\text{C}_7\text{H}_{16}$) to measure the octane number of gasoline. It is an important component of gasoline, frequently used in relatively large proportions to increase the knock resistance of the fuel (See Figure 18).

Isopentane: See Natural Gasoline.

IVT: Initial vaporization temperature of a cut, usually based on a crude assay distillation.

Jack: An oil well pumping unit that operates with an up-and-down, or seesawing motion; also called a pumping jack.

Jet fuel: A kerosene material of typical ASTM D86 boiling point range 400–550 °F (205–288 °C) used as a fuel for commercial jet aircraft.

Joule Thompson expansion: The pressure of a mixture is reduced with no heat transfer to or from the surroundings. A pressure decrease typically results in a temperature decrease except for systems comprised largely of hydrogen gas.

Joule-Thompson Effect: 1. The change in temperature of a fluid that occurs when the fluid is allowed to expand in such a way that no external work is done and no heat transfer takes place. The case of most interest is cooling of a compressed gas upon J-T expansion. NB: the J-T effect is not limited to gases; J-T expansion can, in some cases, produce an increase in temperature rather than a decrease, although this is not frequently encountered. 2. Thermodynamic effect in a fluid whereby the reduction in its temperature is caused by pressure reduction without energy exchange with the environment. 3. When a real (not ideal) gas expands, the temperature of the gas drops. During passage of a gas through a choke, the internal energy is transferred to kinetic energy with a corresponding reduction in temperature as velocity increases. The effect for natural gas is approximately 7°F for every 100 psi pressure reduction.

Joule-Thompson Valve: A device which, taking an advantage of the Joule-Thompson effect enables the cooling of a fluid through throttling or reduction of its pressure.

K factor: Sometimes used as synonym for characterization factor.

K-value: Shortcut notation for the equilibrium K value.

Kerogene: An initial stage of oil that never developed completely into crude. Typical of oil shales.

Kerosene/Kerosine: 1. A medium range ($\text{C}_9 - \text{C}_{16}$) straight chain blend of hydrocarbons. The flash point is

about 140°F (60°C), the boiling point is 345°F – 550°F (174°C – 288°C) and the density is 747–775 kg/m³. 2. A medium-light distillate from the oil refining process; used for lighting and heating and for the manufacture of fuel for jet and turboprop aircraft engines. 3. Any petroleum product with a boiling range between the approximate limits of 284°F and 518°F (140°C and 270°C), which satisfies a specific quantity requirements. 4. A middle distillate product material from distillation of crude oil that boils in the approximate ASTM D86 range of 400–550°F (205–288°C) or from thermal and catalytic cracking operations (coker, visbreaker, FCC, hydrocracker, etc.). The exact cut is determined by various specifications of the finished kerosene. 5. A light petroleum distillate that is used in space heaters, cook stoves, and water heaters and is suitable for use as a light source when burned in wick-fed lamps. Kerosene has a maximum distillation temperature of 400°F (204°C) at the 10% recovery point, a final boiling point of 572°F (300°C), and a minimum flash point of 100°F (38°C). Included are No. 1-K and No. 2 – K, the two grades recognized by the American Society of Testing Materials (ASTM) Specification D3699 as well as all other grades of kerosene called range or stove oil, which have properties similar to those of No. 1 fuel oil. It is colorless and has a characteristic odor and taste. Kerosene is insoluble in water, moderately soluble in alcohol and very soluble in ether, chloroform or benzene.

Key Components: In a conventional distillation column with two products, two components or groups of components that define the separation. Both components must be distributed to the top and bottom products. The light key appears in the bottom product in a small significant quantity and the heavy key appears in the top product in small significant quantity.

Kinematic viscosity: Viscosity in centipoises (cP) divided by the liquid density at the same temperature gives kinematic viscosity in centistokes (cSt) (100 cSt = 1 stoke). Water is the primary viscosity standard with an accepted viscosity at 20°C of 0.01002 poise. Kinematic viscosity is usually determined by the flow of a substance between two points in a capillary tube.

$$\text{Kinematic viscosity} = \frac{\text{Dynamic viscosity}}{\text{Density of fluid}}, \text{ cSt}$$

$$v = \frac{\mu}{\rho}$$

Kinetic: The word “kinetic” is derived from the Greek word for “motion”. In chemistry, kinetics is the study of how fast reactions occur. In many chemical reactions where there are a number of possible products, the first product formed may be the one that is formed most quickly, not necessarily the one that is most stable; if the reaction is left to proceed, eventually a product is formed that involves the greatest change in bond energy – the thermodynamic product.

Knock: 1. The sound associated with the auto ignition in the combustion chamber of an automobile engine of a portion of the fuel-air mixture ahead of the advancing flame front. 2. The noise associated with premature ignition of the fuel-air mixture in the combustion chamber; also known as detonation or pinking.

Knocking (Knock, Detonation, Spark knock, Pinging or Pinking): In spark-ignition internal combustion engines occurs when combustion of the air/fuel mixture in the cylinder does not start off correctly in response to ignition by the spark plug, but one or more pockets of air/fuel mixture explode outside the envelope of the normal combustion front. *See also Engine Knocking.*

Knocking is more or less unavoidable in diesel engines, where fuel is injected into highly compressed air towards the end of the compression stroke. There is a short lag between the fuel being injected and combustion starting. By this time there is already a quantity of fuel in the combustion chamber which will ignite first in areas of greater oxygen density prior to the combustion of the complete charge. This sudden increase in pressure and temperature causes the distinctive diesel “knock” or “clatter”, some of which must be allowed for in the engine design. Careful design of the injector pump, fuel injector, combustion chamber, piston crown and cylinder head can reduce knocking greatly, and modern engines using electronic common rail injection have very low levels of knock. Engines using indirect injection generally have lower levels of knock than direct injection engine, due to the greater dispersal of oxygen in the combustion chamber and lower injection pressures providing more complete mixing of fuel and air.

Knocking should not be confused with pre-ignition – they are two separate events. However, pre-ignition is usually followed by knocking. See Pre-ignition.

Knockout: A separator used to remove excess gas or water from the produced fluid stream.

Knockout Drum: A vessel wherein suspended liquid is separated from gas or vapor.

Laminar flow: The streamline flow of a fluid in which a fluid flows without fluctuations or turbulence. The velocities of fluid molecules are in the direction of flow with only minor movement across the streamlines caused by molecular diffusion. The existence was first demonstrated by Osborne Reynolds who injected a trace of colored fluid into a flow of water in a glass pipe. At low flow rates, the colored fluid was observed to remain as discrete filaments along the tube axis, indicating flow in parallel streams. At increased flow rates, oscillations were observed in the filaments, which eventually broke up and dispersed across the tube. There appeared to be a critical point for a particular tube and fluid above which the oscillations occurred. By varying the various parameters, Reynolds showed that the results could be correlated into terms of a dimensionless number called the Reynolds number, Re . This is expressed by:

$$Re = \frac{\rho v d}{\mu}$$

where ρ is the density of the fluid, v is the velocity of the fluid, d is the inside diameter of the pipe, and μ is the fluid viscosity. The critical value of Re for the break-up of laminar flow in the pipes of circular cross-section is about 2000.

LCGO: Light coker gas oil.

Leaded Gasoline: A gasoline that has TEL (tetraethyl lead) added to boost the octane number.

Lean Oil: The absorption oil entering the top tray of an absorber column.

Lease Condensate: A mixture consisting primarily of pentanes and heavier hydrocarbons which is recovered as a liquid from natural gas in lease separation facilities. This category excludes natural gas liquids, such as propane and butane, which are recovered at downstream natural gas processing plants or facilities. *See also Natural Gas Liquids.*

LHSV: Liquid hour space velocity, volume of feed per hour per volume of catalyst.

LHV: Lower heating value of fuels (net heat of combustion). The heat produced by complete oxidation of materials at 60°F (25°C) to carbon dioxide and water vapor at 60°F (25°C).

Light Cycle Oil (LCO): Gas oil produced in a catalytic cracking operation that boils in the approximate ASTM D86 range of 400–695 °F (205–369°C).

Light Ends: Hydrocarbon fractions in the butane (C_4H_{10}) and lighter boiling range.

Light Gas Oils: Liquid petroleum distillates heavier than naphtha, with an approximate boiling range from 401–650°F (205–343°C).

Light key: A distributed component in a distillation section that is recovered in the top light product, with a small specified amount leaving the bottoms product.

Light oil: Generally gasoline, kerosene and distillate fuels.

Light Straight Run (LSR): The low-boiling naphtha stream from the atmospheric distillation, usually composed of pentanes and hexanes.

Liquefaction: 1. The process by which gaseous natural gas is converted into liquid natural gas. 2. Physical process of gas to liquid that is condensation. For natural gas, this process requires cryogenic temperature since it is impossible to liquefy methane – main component of natural gas – at a temperature above -117°F (-82.6°C), which is its critical temperature.

Liquefaction of Gases: Any process in which a gas is converted from its gaseous into liquid phase.

Liquefaction Plant: Industrial complex that processes natural gas into LNG by removing contaminants and cooling the natural gas into its condensation.

Liquefaction Unit or Liquefaction Train: Equipment that processes purified natural gas and brings it to liquid state. Natural gas has been purified in the pretreatment unit before cooling and liquefying it.

Liquefied Natural Gas (LNG): 1. Natural gas that has been refrigerated to temperatures at which it exists in a liquid state. 2. An odorless, colorless, noncorrosive and non-toxic product of natural gas consisting primarily of methane (CH_4) that is in liquid form at near atmospheric pressure. 3. Natural gas liquefied either by refrigeration or by pressure to facilitate storage or transportation. 4. A liquid composed of chiefly of natural gas (e.g., mostly methane, CH_4). Natural gas is liquefied to make it easy to transport if a pipeline is not feasible (e.g., as across a body of water). LNG must be put under low temperature and high pressure or under extremely low (cryogenic) temperature and close to atmospheric pressure to liquefy. 5. Natural gas mainly methane refrigerated to reach liquid phase suitable for transportation in specialized vessels. 6. Natural gas that has been cooled to -26°F (-32°C) and converted into a liquid so that

its volume will be reduced for transportation. 7. Hydrocarbons mixture, predominantly methane, kept in liquid state at a temperature below its boiling point. 8. Methane that has been compressed and cooled to the liquefaction point for shipping.

Liquefied Petroleum Gas (LPG): 1. Gaseous hydrocarbons at normal temperatures and pressures but that readily turns into liquids under moderate pressure at normal temperatures, i.e., propane, (C_3H_8) and butane (C_4H_{10}). 2. Butane and propane mixture, separated from well fluid stream. LPG can be transported under pressure in refrigerated vessels (LPG carriers). 3. A mixture of propane and butane, and other light hydrocarbons derived from refining crude oil. At normal temperatures, it is a gas, but it can be cooled or subjected to pressure to facilitate storage and transportation. 4. of the gaseous hydrocarbons, propanes and butanes can be liquefied under relatively low pressure and at ambient temperature. Mixtures of these are known as LPG. 5. A mixture of propane, propylene, butane and butylenes. When compressed moderately at normal temperature, it becomes a liquid. It is obtained as light ends from fractionation of crude oil. It has a good caloric value; it is used as cooking fuel; because LPG has no natural odor, a distinctive odorant is added so that it will be noticeable should a leak occur. 6. Light ends, usually C_3 and C_4 gases liquefied for storage and transport. 7. Propane, propylene, normal butane, butylenes, isobutane and isobutylene produced at refineries or natural gas processing plant (includes plants that fractionate raw natural gas plant liquids). 8. A group of hydrocarbons-based gases derived from crude oil refining or natural gas fractionation. They include ethane, ethylene, propane, propylene, normal butane, butylenes, isobutane and isobutylene. For convenience of transportation, these gases are liquefied through pressurization.

Liquefied Refinery Gases: Liquefied petroleum gases fractionated from refinery or still gases. Through compression and/or refrigeration, they are retained in liquid state. The reported categories are ethane/ethylene, propane/propylene, normal butane/butylene and isobutane/isobutylene.

Liquid Extraction: Light and heavy liquid phases are contacted in a column with contact surfaces and possibly mixing. Some components are transferred (extracted) from one liquid phase to the other.

Lock-Out-Tag-Out (LOTO): Refers to a program to control hazardous energy during the servicing and

maintenance of machinery and equipment. Lock-out refers to the placement of a locking mechanism on energy-isolating device, such as a valve, so that the equipment cannot be operated until the mechanism is removed. Tag-out refers to the secure placement of a tag on energy-isolating device to indicate that the equipment cannot be operated until the tag is removed.

Long Residue: The bottoms stream from the atmospheric distillation tower.

Long-term exposure limit (LTEL): The time-weighted average concentration of a substance over an 8-h period thought not to be injurious to health.

Lower Explosive Limit (LEL): The minimum concentration of combustible gas or vapor in air below which propagation of flame does not occur on contact with an ignition source. Also known as the lower flammable limit or the lower explosion limit.

Low Pressure (LP): A processing unit operating at less than 225 psig measured at the outlet separator.

Lubricants: Substances used to reduce friction between bearing surfaces or as process materials either incorporated into other materials used as processing aids in the manufacture of other products, or used as carriers of other materials. Petroleum lubricants may be produced either from distillates or residues. Lubricants include all grades of lubricating oils from spindle oil to cylinder oil and those used in greases.

Light Vacuum Gas Oil (LVGO): A side stream from the vacuum distillation tower.

Make Up Stream: A feed to a process to replace a component that reacts or is otherwise depleted in a process.

Main Cryogenic Heat Exchanger: Main heat exchanger in the liquefaction unit where cooling and liquefaction of natural gas take place by means of heat exchange with cooling fluids.

Main Fractionators: The first distillation column for a FCC or coking process.

Main Line: Branch or lateral sewers that collect wastewater from building sewers and service lines.

Main Sewers: A sewer that receives wastewater from many tributary branches and sewer lines and serves as an outlet for a large territory or is used to feed an intercepting sewer.

Management of Change (MOC): 1. A process to understand all the implications of a change to a procedure. 2. A process for evaluating and controlling hazards that may be introduced during modifications to facility, equipment, operations, personnel or activities; MOCs can also be used to identify, evaluate and control unintended hazards introduced by modifying procedures or when developing a new plan or procedure.

Manhole: An opening in a sewer provided for the purpose of permitting operators or equipment to enter or leave a sewer. Sometimes called an “access hole” or a “maintenance hole”.

Manifold(s): 1. A junction or center for connecting several pipes and selectively routing the flow. 2. A pipe spool in which a number of incoming pipes are combined to feed to a common output line.

Manometer: Instrument for measuring head or pressure; basically a U-tube partially filled with a liquid, so constructed that the difference in level of the liquid leg indicates the pressure exerted on the instrument.

MAOP: See *Maximum allowable operating pressure*.

Mass Balance: Summation of the mass entering a process and the summation of the mass leaving a process. They must equal for a steady-state process.

Material Safety Data Sheet (MSDS): 1. A description of the Health, Safety and Environment (HSE) data for a marketed product. 2. Printed information that describes the properties of a hazardous chemical and ways to control its hazards. 3. A document that provides pertinent information and a profile of a particular hazardous substance or mixture. An MSDS is normally developed by the manufacturer or formulator of the hazardous substance or mixture. The MSDS is required to be made available to employees and operators whenever there is the likelihood of the hazardous substance or mixture being introduced into the workplace.

MAWP: See *Maximum allowable working pressure*.

Maximum Allowable Operating Pressure (MAOP): The maximum gas pressure at which a pipeline system or process facility is allowed to operate.

Maximum Allowable Working Pressure (MAWP): 1. This is a legal maximum pressure that a process vessel is allowed to experience. Above this pressure, a relief valve should open to protect the vessel from catastrophic failure. 2. The maximum pressure to which a surface

vessel can be operated or the maximum pressure during treating to which a well should be exposed.

Mechanical Seal: This is the part of a centrifugal pump that keeps the liquid from squirting out along the shaft. It is often subject to leakage due to pump vibration and cavitation.

Melting Point: The temperature at which a solid turns into a liquid. As temperature is a measure of the kinetic energy of molecules (i.e., how much they are moving around), this means that the molecules are moving too much to stay in one place.

Mercaptans: 1. Compounds of carbon, hydrogen, and sulfur (RSH, R = CH₃) found in sour crude and gas; the lower mercaptans have a strong, repulsive odor and are used, among other things to odorize natural gas. 2. A class of compounds containing carbon, hydrogen, and sulfur. The shorter chain materials are used as odor marker in natural gas. 3. Organic sulfides of the formula RSH where R represents the organic radical and SH represents the thiol group.

Methane (CH₄): A light odorless flammable gas that is the principal component of natural gas.

Methanol (CH₃OH): Methyl alcohol from the general formula (ROH), where R = C_nH_{2n+1} is known as a radical and n = 1, 2, 3, etc. Methanol can be made by the destructive distillation of wood or through a process starting with methane or a heavier hydrocarbon, decomposing it to synthesis gas and recombining it to methanol.

Methyl Tertiary Butyl Ether (MTBE, - (CH₃)₃COCH₃): 1. Is manufactured by etherification of methanol and isobutylene. Methanol is derived from natural gas and isobutylene is derived from butane obtained from crude oil and natural gas. 2. A gasoline additive used to increase octane number. MTBE is produced by reacting methanol (CH₃OH) with isobutylene (iC₄H₈). 3. Blends up to 15.0% by volume of MTBE which must meet the ASTM D4814 specifications. Blenders must take precautions that the blends are not used as base gasolines for other oxygenated blends (commonly referred to as the “Sun waiver”).

An ether intended for gasoline blending as described in oxygenate definition.

In the U.S. it has been used in gasoline at low levels since 1979 to replace tetraethyl lead and to increase its octane rating helping prevent engine knocking. Oxygenates help gasoline burn more completely, reducing tailpipe emissions

from pre-1984 motor vehicles; dilutes or displaces gasoline components such as aromatics (e.g., benzene) and sulfur; and optimizes the oxidation during combustion. Most refiners chose MTBE over other oxygenates primarily for its blending characteristics and low cost.

Middle Distillates: Atmospheric pipe still cuts boiling in the range of 300 - 700°F (149 - 371°C) vaporization temperature. The exact cut is determined by the specifications of the product. 1. A general classification of refined petroleum products that include distillate fuel oil and kerosene. 2. Medium-density refined petroleum products, including kerosene, stove oil, jet fuel and light fuel oil. 3. Refinery products in the middle distillation range of refined products: kerosene, heating oil and jet fuel.

Mid-Percent Point: The vapor temperature at which one half of the material of a cut has been vaporized. Mid-percent point is used to characterize a cut in place of temperature limits.

Mixed Phase: More than one phase. Usually implies both vapor and liquid phase(s) present.

Molecular Sieve: A separation process that usually works by gaseous diffusion. A membrane is selected through which the compounds being removed or purified can pass while the remaining compounds in the stream being processed cannot pass.

MONC: Motor octane number clear (unleaded).

Motor Octane Number (MON, ASTM ON F2): A measure of resistance to self-ignition (knocking) of a gasoline under laboratory conditions that correlates with road performance during highway driving conditions. The percentage by volume of isooctane in a mixture of isooctane and n-heptane that knocks with the same intensity as the fuel being tested. A standardized test engine operating under standardized conditions (900 rpm) is used. This test approximates cruising conditions of an automobile; ASTM D - 2723.

MPHC: Medium pressure hydrocracking or partial conversion hydrocracking.

Motor Gasoline or Petrol: Gasoline is a volatile, flammable, complex petroleum fuel used mainly in internal combustion engines. It is used as fuel in specially designed heaters and lamps.

Motor Gasoline Blending: 1. Naphthas (e.g., straight-run gasoline, alkylate, reformate, benzene, toluene, xylenes) used for blending or compounding

into finished motor gasoline. Includes receipts and inputs of Gasoline Treated as Blendstock (GTAB). Excludes conventional blendstock for oxygenate blending (CBOB), reformulated blendstock for oxygenate blending, oxygenates (e.g., fuel ethanol and methyl tertiary butyl ether), butane, and natural gasoline. 2. Mechanical mixing of motor gasoline blending components, and oxygenates when required, to produce finished motor gasoline. Finished motor gasoline may be further mixed with other motor gasoline blending components or oxygenates, resulting in increased volumes of finished motor gasoline and/or changes in the formulation of finished motor gasoline (e.g., conventional motor gasoline mixed with MTBE to produce oxygenated motor gasoline).

Motor Gasoline Blending Components: Naphthas (e.g., straight-run gasoline, alkylate, reformate, benzene, toluene, xylene) used for blending or compounding into finished motor gasoline. These components include reformulated gasoline blendstock for oxygenate blending (RBOB), but exclude oxygenates (alcohols, ethers), butane and pentanes plus.

Motor gasoline (finished): A complex mixture of relatively volatile hydrocarbons with or without small quantities of additives, blended to form a fuel suitable for use in spark-ignition engines. Motor gasoline as defined in ASTM Specification D4814 or Federal Specification VV - G - 1690C, is characterized as having boiling range of 122°F to 158°F (50°C to 70°C) at the 10% recovery point to 365°F to 374°F (185°C to 190°C) at the 90% recovery point. "Motor gasoline" includes conventional gasoline; all types of oxygenated gasoline, including gasohol; and reformulated gasoline but excludes aviation gasoline

Naphtha: 1. Straight-run gasoline distillate, below the boiling point of kerosene. Naphthas are generally unsuitable for blending as a component of premium gasoline; hence they are used as a feedstock for catalytic reforming in hydrocarbon production processes or in chemical manufacturing processes. 2. A term that is applied to low boiling mixtures of hydrocarbons with typical TBP boiling ranges between 150–450°F (66–233°C). Light and heavy naphthas are produced in the distillation of crude oils. Cracked naphthas are also produced by many of the refinery reaction processes.

Naphthas are subdivided according to the actual pipe still cuts - into light, intermediate and heavy and very heavy virgin naphthas. A typical pipe still operation would be

C_5 –160°F (C_5 –71°C): light virgin naphtha
 160–280°F (71–138°C): intermediate virgin naphtha
 280–380°F (138–193°C): heavy virgin naphtha

Naphtha, the major constituents of gasoline, generally needs processing to make a suitable quality gasoline.

Naphtha less than 401°F: A naphtha with a boiling range of less than 401°F (205°C) that is intended for use as a petrochemical feedstock.

Naphtha-Type Jet Fuel: A fuel in the heavy naphtha boiling range having an average gravity of 52.8 °API, 20 to 90 percent distillation temperature of 290–470°F (143–243°C) and meeting Military Specification MIL – T- 5624L (Grade JP – 4). It is used primarily for military turbojet and turboprop aircraft engines because it has a lower freeze point than other aviation fuels and meets engine requirements at high altitudes and speeds.

Special Naphthas: All finished products within the naphtha boiling range that are used as paint thinners, cleaners, or solvents. These products are refined to a specified flash point. Special naphthas include all commercial hexane and cleaning solvents conforming to ASTM Specification D 1836 and D484, respectively. Naphthas to be blended or marketed as motor gasoline or aviation gasoline and synthetic natural gas (SNG) feedstocks are excluded.

Naphthenes: Hydrocarbons of the cyclane family, sometimes called cycloalkanes. Naphthenes have no double bonds and are saturated ring structures with the general formula C_nH_{2n} , where C = carbon atoms, H = hydrogen atoms, and $n = 6, 7, 8, \dots$

Naphthenic: Having the characteristics of naphthenes, saturated hydrocarbons whose molecules contain at least one closed ring of carbon atoms.

Naphthenic Acids: Organic acids occurring in petroleum that contain a naphthenic ring and one or more carboxylic acid groups. Naphthenic acids are used in the manufacture of paint driers and industrial soaps.

Naphthenic Crudes: A type of crude petroleum containing a relatively large proportion of naphthenic-type hydrocarbon.

Natural Gas: Naturally occurring gas consisting predominantly of methane, sometimes in conjunction with crude (associated gas) and sometimes alone (unassociated gas). 1. A mixture of light hydrocarbons found naturally in the Earth's crust, often in association with oil (when it is known as associated gas). Methane is the

most dominant component. It may also include some short-chain hydrocarbons (ethane, propane, butane) that may be in gaseous state at standard conditions. 2. A mixture of hydrocarbon compounds and small quantities of various non-hydrocarbons existing in the gaseous phase or in solution with crude oil in natural underground reservoirs at reservoir conditions. The primary constituent compound is CH_4 . Gas coming from wells also can contain significant amounts of ethane (C_2H_6), propane (C_3H_8), butane (C_4H_{10}) and pentanes (C_5H_{12}) and widely varying amounts of carbon dioxide (CO_2) and nitrogen (N_2).

Natural Gas Heating Value: The amount of thermal energy released by the complete combustion of one standard cubic foot of natural gas.

Natural Gas Liquids (NGL): 1. Liquid hydrocarbons, such as ethane, propane, butane, pentane, and natural gasoline, extracted from field natural gas. 2. Those hydrocarbons in natural gas that are separated from the gas as liquids through the process of absorption, condensation, adsorption, or other methods of gas processing or cycling plants. Generally, such liquids consist of propane and heavier hydrocarbons and are commonly referred to as lease condensate, natural gasoline and liquefied petroleum gases. Natural gas liquids include natural gas plant liquids (primarily ethane, propane, butane and isobutane. See Natural gas plant liquids and lease condensate (primarily pentanes produced from natural gas at lease separators and field facilities). 3. Liquids obtained during natural gas production that include ethane, propane, butanes and condensate.

Natural Gasoline: A gasoline range product separated at a location near the point of production from natural gas streams and used as a gasoline blending component.

Natural Gasoline and Isopentane: A mixture of hydrocarbons, mostly pentanes and heavier, extracted from natural gas, that meets vapor pressure, end point and other specifications for natural gasoline set by the Gas Processors Association. Includes isopentane that is a saturated branch-chain hydrocarbon (iC_5H_{12}), obtained by fractionation of natural gasoline or isomerization of normal pentane (nC_5H_{12}).

Natural Gas Plant Liquids: Those hydrocarbons in natural gas that are separated as liquids at natural gas processing plants, fractionating and cycling plants, and in some instances, field facilities. Lease condensate is excluded. Products obtained include ethane, liquefied

petroleum gases (propane, butanes, propane-butane mixtures, ethane-propane mixtures), isopentane, and other small quantities of finished products, such as motor gasoline, special naphthas, jet fuel, kerosene and distillate fuel oil.

Natural Gas Processing: 1. The purification of field gas at natural gas processing plants (or gas plants) or the fractionation of mixed NGLs to natural gas products to meet specifications for use of pipeline-quality gas. Gas processing includes removing liquids, solids and vapors absorbing impurities and odorizing. 2. The process of separating natural gas liquids (NGLs) by absorption, adsorption, refrigeration, or cryogenics from a stream of natural gas.

Natural Gas Processing Plant: Facilities designed to recover natural gas liquids from a stream of natural gas that may or may not have passed through lease separators and/or field separation facilities. These facilities control the quality of the natural gas to be marketed. Cycling plants are classified as gas processing plants.

Net Heating Value: is the total energy transferred as heat in an ideal combustion reaction at a standard temperature and pressure in which all water formed appears as vapor. The net heating is an ideal gas property in a hypothetical state (the water cannot all remain vapor because, after the water saturates the CO_2 in the products, the rest would condense).

Net Positive Suction Head (NPSH): The net positive suction head required to keep a centrifugal pump from cavitating. Cooling a liquid in a pump's suction line increases the pump's available NPSH, as does increasing the liquid level in the suction drum.

Nonassociated gas: Natural gas that exists in a reservoir alone and is produced without any crude oil.

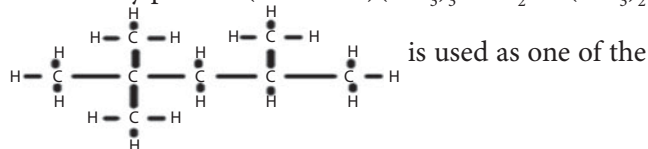
Normal boiling point: See *boiling point*.

Nusselt number (Nu): A dimensionless number Nu is used in heat transfer calculations characterizing the relation between the convective heat transfer of the boundary layer of a fluid and its thermal conductivity.

$$\text{Nu} = \frac{hd}{k}$$

Where h is the surface heat transfer coefficient, d is the thickness of the fluid film, and k is the thermal conductivity.

Octane (C_8H_{18}): 1. Is a hydrocarbon and an alkane with the chemical formula C_8H_{18} , and the condensed structural formula $\text{CH}_3(\text{CH}_2)_6\text{CH}_3$. Octane has many structural isomers that differ by the amount and location of branching in the carbon chain. One of the isomers, 2, 2, 4-trimethylpentane (isooctane) $(\text{CH}_3)_3\text{CCH}_2\text{CH}(\text{CH}_3)_2$



is used as one of the

standard values in the octane rating scale. Octane is a component of gasoline (petrol). As with all low molecular weight hydrocarbons, octane is volatile and very flammable. 2. A test used to measure the suitability of a gasoline as motor fuel. The octane test determines the knocking characteristics of a gasoline in a standard test engine relative to a standard of 2-2-4 trimethyl pentane (2 2 4 TMP). 2 2 4 TMP is assigned an octane number of 100.0. There are two octane tests. One is designated the research octane (F-1) and the second as the motor octane (F-2). Motor octane is determined in an engine more representative of actual operating conditions for automobiles and is lower than research octane for any gasoline stock.

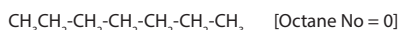
Historically, gasoline was marketed based on the F-1 octane, but in recent years, the average of the F-1 and F-2 octane has been used. At the gasoline pump, this is reported as $(R + M)/2$.

The Research Octane Number (RON) test simulates driving mild conditions while the Motor Octane Number (MON) test simulates driving under more severe conditions, i.e., under load and at high speeds. The arithmetic average of RON and MON, which gives an indication of the performance of the engine under the full range of condition, is projected as Anti Knock Index (AKI), i.e. Anti Knock Index (AKI) = $(\text{RON} + \text{MON})/2$.

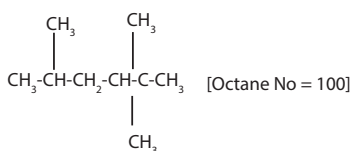
Octane Number: 1. Is a measure of the knocking characteristics of a fuel in a laboratory gasoline engine according to ASTM D2700. We determine the octane number of a fuel by measuring its knocking value compared to the knocking of a mixture of n-heptane and isooctane of 2-2-4 trimethylpentane (224 TMP). 2. An index measured by finding a blend of isooctane (iC_8H_{18}) and normal heptanes (nC_7H_{16}) that knocks under the identical conditions as the gasoline being evaluated. It is a measure of the ease of self-ignition of a fuel without the aid of a spark plug. 3. The octane number is a measure of the antiknock resistance of a gasoline. It is the percentage of iso-octane in a mixture of iso-octane and n-heptane, which gives a knock

of the same intensity as the fuel being measured when compared in a standard engine. For example, if the fuel being tested matches in knocking to a blend of 90% iso-octane and 10% n-heptane, then the test fuel is said to have an octane number of 90.

Iso-octane which produces the least knocking or which knocks only at a much higher compression ratio is given an octane number of 100, while n-heptane which is very poor in its resistance to knocking or which knocks at a much lower compression ratio is given an octane number of zero.



n-heptane

Iso-octane
[2,2,4-trimethyl pentane]

Generally, octane number increases as the degree of branching of the carbon chain increases and thus iso-paraffins are found to give higher octane numbers than the corresponding normal isomers. Olefins are found to give higher octane numbers than the related paraffins. Naphthenes also give better octane numbers than the corresponding normal paraffins. Aromatics usually exhibit high octane numbers.

A single cylinder test engine is made to obtain the antiknock characteristics of gasoline in terms of octane numbers. The octane numbers formed a scale ranging

from 0 to 100; the higher the number the greater the antiknock characteristics. The scale has been extended above 100 by comparing the knocking intensity with iso-octane to which tetraethyl lead (TEL) is added. Numbers greater 100 on the scale are referred to as performance numbers rather than octane numbers. *See also Motor Octane number and Research Octane number.*

Octane numbers are very relevant in the reforming, isomerization and alkylation processes in refining facilities. These processes enable the successful reactive transformations to yield long side chain paraffins and aromatics that possess higher octane numbers than the feed constituents which do not consist of higher quantities of constituents possessing straight chain paraffins and non-aromatics (naphthenes).

It is a measure of the ease of self-ignition of a fuel without the aid of a spark plug.

Octane Scale: A series of arbitrary numbers from 0 to 120.3 used to rate the octane number of gasoline. Three reference materials define the scale; n-heptane (Octane number = 0), isooctane (Octane number = 100), and isooctane plus six ml tetramethyl lead (Octane number = 120.3). Above 100, the octane number of a fuel is based on the engine ratings, in terms of ml of tetra ethyl lead in isooctane which matches that of the unknown fuel.

Off Gas: The gas leaving a reflux drum or top tray of an absorber column.

Off Line: When a process unit is shut down it is said to be off line.

Table 1 Octane numbers of pure hydrocarbons*

Hydrocarbon	RON	MON	Hydrocarbon	RON	MON
n-pentane	61.7	61.9	2,4 - Dimethyl hexane	62.5	69.9
n-hexane	24.8	26.0	2,2,4 - Trimethyl pentane (iso-octane)	100.0	100.0
n-heptane	0.0	0.0	1 - Pentene	90.9	77.1
n-octane	-19.5	-15.0	1 - Octane	28.7	34.7
n-nonane	-17.0	-20.0	3 - Octene	72.5	68.1
2-methyl butane (Iso-pentane)	92.3	90.3	4 - Methyl - 1- Pentene	95.7	80.9
2 - Methyl hexane (Iso-heptane)	42.4	46.4	Benzene	-	114.8
2 - Methyl heptane (Iso-octane)	21.7	23.8	Toluene	120.1	103.5

* (Source: Speight, James G., *The Chemistry & Technology of Petroleum*, Marcel Dekker, Inc. 1991).

Oil: One of the various liquid, viscid, usually inflammable, chemically neutral substances that is lighter and insoluble in water, but soluble in alcohol and ether and classified as non-volatile. Natural plant oils comprise terpenes and simple esters such as essential oils. Animal oils are glycerides of fatty acids. Mineral oils are mixtures of hydrocarbons. Oils have many uses and include fuels lubricants, soap constituents, vanishes, etc.

Oil and gas: Refer to the industry associated with the recovery of liquid and gaseous hydrocarbons from underground deposits as reservoirs found both onshore and offshore around the world. A collection of localized deposits is known as an oil field or gas field. When they are drilled, they are known as oil and gas wells. Oil is mainly used as fuel for transportation purposes, whereas gas is primarily used as fuel for domestic and industrial purposes, and for converting into other chemicals such as plastic. Oil is widely transported in ships. Gas is transported in underground, sub-sea, or overland pipelines covering large distances.

Oil refinery: An industrial process plant where crude oil is converted into useful products such as naphtha, diesel fuel, kerosene, and LPG. Also known as petroleum refinery, the process involves the separation of the crude oil into fraction in the process of fractional distillation. By boiling the crude oil, the light or more volatile components with the lowest boiling point rise towards the top of the column, whereas the heavy fractions with the highest boiling points remain at the bottom. The heavy bottom fractions are then thermally cracked to form more useful light products. All the fractions are then processed further in other parts of the oil refinery, which may typically feature vacuum distillation used to distill the bottoms; hydrotreating, which is used to remove sulfur from naphtha, catalytic cracking, fluid catalytic cracking, hydrocracking, visbreaking, isomerization, steam reforming, alkylation, hydrosulfurization, and the Claus process used to convert hydrogen sulfide into sulfur, solvent dewaxing and water treatment.

Olefins: Hydrocarbons of the alkenes family. Olefins have two carbon atoms in the molecular structure linked by a double bond to satisfy the absence of two hydrogen atoms that are present in the corresponding paraffin. This hydrogen deficiency is called unsaturation. The general formula for olefins is C_nH_{2n} , where C = carbon atoms, H = hydrogen atoms, and $n = 2, 4, 6$.

Olefins do not occur naturally in crude oil and are created in the thermal and catalytic cracking processes.

Online: When a process unit is in operation and processing feed, it is said to be online.

OPEC: Organization of Petroleum Exporting Countries. These countries have organized for the purpose of negotiating with oil companies on matters of oil production, prices and future concession rights. Current members are Algeria, Indonesia, Iran, Kuwait, Libya, Nigeria, Qatar, Saudi Arabia, United Arab Emirates and Venezuela.

Operability Capacity: 1. The amount of capacity that, at the beginning of the period, is in operation; not in operation and not under active repair, but capable of being placed in operation within 30 days; or not in operation but under active repair that can be completed within 90 days. Operable capacity is the sum of the operating and idle capacity and is measured in barrels per calendar day or barrels per stream day. 2. The component of operable capacity that is operation at the beginning of the period.

Operating Pressure: Pressure indicated by a gauge when the system is in normal operation (working pressure).

Operation and Maintenance Manual: A manual that describes detailed procedures for operators to

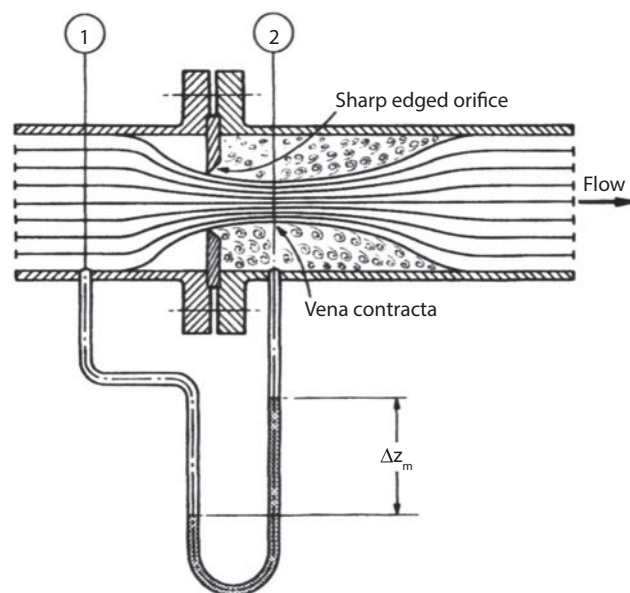


Figure 19 Orifice Meter with Vena contracta formation.

follow to operate and maintain specific water or wastewater treatment, pretreatment or process plants and the equipment of the plants.

Operator: 1. Term used to describe a company appointed by venture stakeholders to take primary responsibility for day- to-day operations for a specific plant or activity. 2. The company or individual responsible for managing an exploration, development or production operation. 3. The company that has legal authority to drill wells and undertake the production of hydrocarbons that are found. The operator is often part of a consortium and acts on behalf of this consortium. 4. The company that makes the decisions and is responsible for drilling, completing, operating and repairing the well.

Operable Utilization Rate: Represents the utilization of the atmospheric crude oil distillation units. The rate is calculated by dividing the gross input to these units by the operable refining capacity of the units.

Organic Compounds: Compounds that include carbon and hydrogen atoms. Generally organic compounds can be classified as either aliphatics (straight chain compounds), cyclic (compounds with ring structures), and combinations of aliphatics and cyclic.

Orifice: An opening in wall or plate used to control the rate of flow into or out of a tank or pipe.

Orifice Meter: A single phase flow meter, primarily for gas that measures the pressure drop created by the hole as gas is flowed (See Figure 19).

Orifice Plate: Part of an orifice metering system. A plate with a hole through which a single phase flow produces a pressure drop.

Other Hydrocarbons: Materials received by a refinery and consumed as a raw material. Includes hydrogen, coal tar derivatives, gilsonite, and natural gas received by the refinery for reforming into hydrogen. Natural gas to be used as fuel is excluded.

OSHA: 1. Occupational Safety and Health Administration: U.S. government agency. 2. The Williams-Steiger Occupational Safety and Health Act of 1970 (OSHA) is a federal law designed to protect the health and safety of industrial workers, including the operators of water supply and treatment systems and wastewater treatment plants. The Act regulates the design, construction, operation, and maintenance of water supply systems, water treatment plants,

wastewater collection systems, and wastewater treatment plants. OSHA also refers to the federal and state agencies that administer the OSHA regulations.

Oxidation: Oxidation is the addition of oxygen, removal of hydrogen, or the removal of electrons from an element or compound. In the environment, organic matter is oxidized to more stable substances. The opposite is the reduction.

Oxidation Inhibitor: A substance added in small quantities to a petroleum product to increase its oxidation resistance, thereby lengthening its service or storage life; also called an antioxidant. Oxidation of fuels creates gums which become colloidal, then agglomerate and precipitate. Cracked distillates are found more prone to oxidation and deterioration than straight run distillates. Oxidation fuels can also result in the formation of various acids, ketones, aldehydes and esters from hydrocarbons. Amino guanidine derivatives when used in the range 3–30 ppm are found effective as antioxidants. Cyclic borates of polymers alkanolamines are effective anti-oxidants even in the 10 ppm range.

Oxidation Stability: 1. It is used for the evaluation of storage stability and resistance to oxidation as most of the oils, when exposed to air over time, react with oxygen, which are then degraded. Oil with poor oxidation stability, forms corrosive acids at high temperature condition in the engine. 2. Gasoline contains cracked components having tendency to form gum materials during storage and handling which affect performance. Oxidation stability provides an indication of the tendency of gasoline and aviation fuels to form gum in storage. In this test, the sample is oxidized inside a stainless steel pressure vessel initially charge with oxygen at 689 kPa and heated in a boiling water bath. The amount of time required for a specified drop in pressure (gasoline) or the amount of gum and precipitate formed after specific aging period (aviation fuel) is determined.

Oxidizers: Reactants that oxidize, for example, bleach, chlorine, sodium hypochlorite, sodium persulfate. Also, a compound that releases oxygen.

Oxidizing Agent: Any substance, such as oxygen (O_2) or chlorine (Cl_2) that will readily add (take on) electrons. The opposite is a reducing agent.

Oxygen: A chemical element used by all known life forms for respiration.

Oxygenated Fuel: Any organic compound containing oxygen. Specifically for the petroleum industry, this term refers to oxygen-containing organic compounds, such as ethers, and alcohols, added to fuels to reduce carbon monoxide in the engine exhausts. They are used as gasoline blending components. Oxygenated fuels tend to give a more complete combustion of its carbon into carbon dioxide (rather than monoxide), thereby reducing air pollution from exhaust emissions.

Oxygenated Fuels Program Reformulated Gasoline: A reformulated gasoline that is intended for use in an oxygenated fuels program control area during an oxygenated fuels program control period.

Oxygenated Gasoline: 1. Gasoline with an oxygen content of 1.8% or higher, by weight that has been formulated for use in motor vehicles. 2. Finished motor gasoline, other than reformulated gasoline, having an oxygen content 2.7% or higher by weight. It includes gasohol.

Oxygenates: Substances that, when added to gasoline, increase the amount of oxygen in that gasoline blend, and thus boost the octane number of gasoline or petrol. Ethanol, methyl tertiary butyl ether (MTBE), ethyl tertiary butyl ether (ETBE), tertiary amyl methyl ether (TAME) and methanol are common oxygenates. MTBE, ETBE, TAME have 1. Low water solubility, 2. Lower volatility and 3. Compatibility with hydrocarbon fuels.

Overall Tray Efficiency: Overall tray efficiency can be defined as the number of theoretical trays in a distillation column section divided by the number of actual trays in the section and is reported as a percentage. Overall tray efficiencies are less than 100% for all refinery distillation columns.

Overflash: The liquid that returns to the flash zone of a column.

Overhead: Usually refers to the vapor leaving the top tray of a distillation column. For an absorber column the overhead and the top product are the same.

Overlap: See *Gap*.

Overpressure: Is any pressure relative to ambient pressure caused by an explosive blast, both positive and negative.

Ozone (O₃): An oxygen molecule with three oxygen atoms that occurs as a blue, harmful, pungent-smelling gas at room temperature. The stratosphere ozone layer,

which is a concentration of ozone molecules located at 6 to 30 miles above sea level, is in a state of dynamic equilibrium. Ultra violet radiation forms the ozone from oxygen but can also reduce the ozone back to oxygen. The process absorbs most of the ultraviolet radiation from the sun, shielding life from the harmful effects of radiation.

Packed Bed Scrubber: Vertical or horizontal vessels, partially filled with packing or devices of large surface area, used for the continuous contact of liquid and gas such that absorption can take place. Frequently, the scrubber liquid or liquor has had chemicals added to react with the absorbed gas.

Packing (Seals): Seals around a moving shaft or other equipment.

Paraffins: 1. Hydrocarbons of the alkanes family. Paraffins are saturated compounds, i.e., hydrogen atoms are appropriately attached to the carbon atoms such that the carbon atoms have only single bonds in the molecular structure. General formula for paraffin is C_nH_{2n+2}, where C = carbon atoms, H = hydrogen atoms, and n = 1, 2, 3, 4, 5, ...2. A white, odorless, tasteless, chemically inert, waxy substance derived from distilling petroleum; a crystalline, flammable substance composed of saturated hydrocarbons. 3. Normal or straight carbon chain alkanes with carbon chain lengths of C₁₈₊. The alkanes in this range solidify at temperatures from 80°F to over 200°F (27°C – 93°C).

Partial Pressure: In a gaseous mixture, the pressure contribution for a particular component of the mixture. The sum of the partial pressures of the components in the mixture is the total pressure. For example, in a mixture of two components A and B, with partial pressures as p_A, p_B respectively. The total pressure p_{Total} is: $P_{Total} = P_A + P_B$.

Penetration: A measure of the hardness and consistency of asphalt in terms of the depth that a special pointed device will penetrate the product in a set time and temperature.

Performance Rating: A method of expressing the quality of a high-octane gasoline relative to isooctane. This rating is used for fuels that are of better quality than isooctane.

Petroleum Administration for Defense Districts (PADD): Geographic aggregations of the 50 U.S. states and the District of Columbia into five districts by the Petroleum Administration for Defense in 1950. These

districts were originally defined during World War II for purposes of administering oil allocation.

Petroleum Coke: A residue high in carbon content and low in hydrogen that is the final product of thermal decomposition in the condensation process in cracking. This product is reported as marketable coke. The conversion is 5 barrels (of 42 U.S. gallons each) per short ton. Coke from petroleum has a heating value of 6.024 million Btu per barrel.

Marketable coke: Those grades of coke produced in delayed or fluid cokers which may be recovered as relatively pure carbon. This “green” coke may be sold as is or further purified by calcining.

Catalyst coke: The only catalytic coke used as a fuel is the coke on catalyst in the FCC process. In other catalytic processes there is coke deposited on catalyst, but it is not regenerated in a way such that the heat of combustion is recovered.

Petrolatum: Microcrystalline wax or Petroleum jelly.

Petroleum ether: A volatile fraction of petroleum consisting mainly pentanes and hexanes.

Petrochemical Feedstocks: Chemical feedstocks derived from petroleum principally for the manufacture of chemicals, synthetic rubber, and a variety of plastics. These categories reported are “Naphthas less than 401°F and Other Oils Equal to or greater than 401°F”.

Petroleum Products: Petroleum products are obtained from the processing of crude oil (including

lease condensate), natural gas, and other hydrocarbon compounds. Petroleum products include unfinished oils, liquefied petroleum gases, pentanes plus, aviation gasoline, motor gasoline, naphtha type jet fuel, kerosene-type jet fuel, kerosene, distillate fuel oil, residual fuel oil, petrochemical feedstocks, special naphthas, lubricants, waxes, petroleum coke, asphalt, road oil, still gas, and miscellaneous products.

Phase Envelope: 1. The boundaries of an area on the P-T diagram for the material which encloses the region where both vapor and liquid coexist. 2. Phase diagram or phase envelope is a relation between temperature and pressure that shows the condition of equilibria between the different phases of chemical compounds, mixture of compounds, and solutions. Phase diagram is an important issue in chemical thermodynamics and hydrocarbon reservoir. It is very useful for process simulation, hydrocarbon reactor design, and petroleum engineering studies. It is constructed from the bubble line, dew line, and critical point. Bubble line and dew line are composed of bubble points and dew points, respectively. Bubble point is the first point at which the gas is formed when a liquid is heated. Meanwhile, dew point is the first point where the liquid is formed when the gas is cooled. Critical point is the point where all of the properties of gases and liquids are equal, such as temperature, pressure, amount of substance, and others. Critical point is very useful in fuel processing and dissolution of certain chemicals

According to thermodynamic definition of phase diagram (phase envelope) is a graph showing the pressure at which transition of different phases from a compound with respect to temperature. Bubble point which forms bubble line is a point separating the liquid phase and the two phases region, namely the liquid phase and the gaseous phase. The dew point which forms the dew line is a point separating the gaseous phase and two phase region, namely the liquid and gaseous phase. At the dew point, the following conditions must be satisfied (See Figure 20).

Physical Solvent: A liquid capable of absorbing selected gas components by solubility alone without associated chemical reactions.

Fig: 1. A cylindrical device that is inserted into a pipeline to clean the pipeline wall or monitor the internal condition of the pipeline. 2. Device for cleaning a pipeline or separating two liquids being removed down the pipeline. (Intelligent pig – fitted with sensors to check for corrosion or defects in pipelines.).

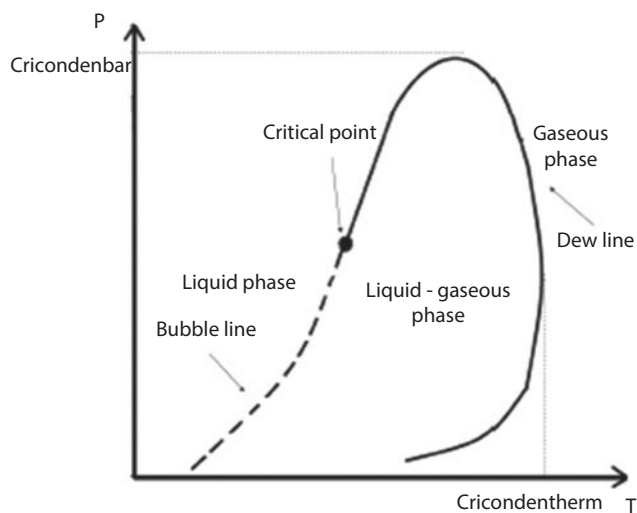


Figure 20 Phase diagram (Phase Envelope).

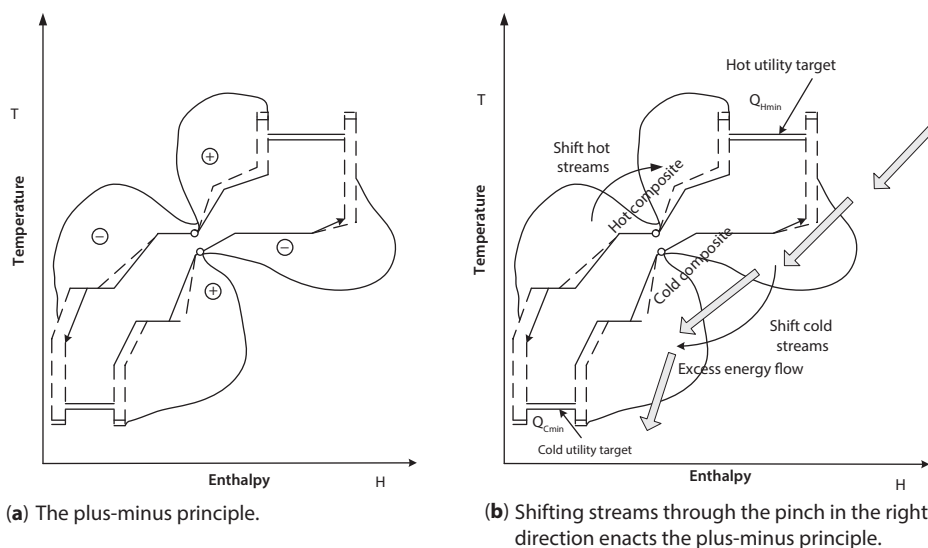


Figure 21 The plus-minus principle guides process design to reduce utility consumption (Source: Smith, R. and Linnhoff, B., Trans. IChemE ChERD, 66, 195, 1988).

3. A flow line clearing device, pumped through the line with normal flow. 4. Refers to a poly pig that is a bullet-shaped device made of hard rubber or similar material. This device is used to clean pipes. It is inserted in one end of a pipe, moves through the pipe under pressure, and is removed from the other end of the pipe.

Pinch analysis: Bodo Linnhoff at the University of Leeds in 1977 developed a technique for minimizing energy usage in a process. It is based on calculating the minimum energy consumption by optimizing the heat recovery, energy supply and process operating conditions. It uses process data represented as energy flows or streams as a function of heat load against temperature. These data are combined for all the hot and cold streams requiring heat. The point of closest approach between the hot and cold composite curves is called the pinch point and corresponds to the point where the design is most constrained. Using this point, the energy targets can be achieved using heat exchange to recover heat between the hot and cold streams in two separate systems, with one temperature above the pinch temperature and one for the temperature below the pinch temperatures.

Figure 21 shows the point in a pinch analysis that corresponds to the point where the hot and cold streams in an integrated process are most constrained.

Pipelines: Tubular arrangement for the transportation of crude oil, refined products and natural gas from the well head, refinery and storage facility to the consumer. Pipeline measures 14–42 in. (356–1067 mm) in

diameter but is usually 20–36 in (508–914 mm). It is often composed of 40 ft. (12 m) lengths, but lengths may be as long as 60 or 80 ft. (18–24 m). The pipe is wrapped and coated for protection against corrosion, especially since it runs underground. About half of all gases and oils are moved by pipeline.

Pipe still: A heater or furnace containing tubes through which oil is pumped while being heated or vaporized. Pipe stills are fired with waste gas, natural gas or heavy oils, and by providing for rapid heating under conditions of high pressure and temperature, are useful for thermal cracking as well as distillation operations.

Pipe size: Process piping comes in particular nominal sizes:

0.75 in.	-
1 in.	25 mm
2 in.	50 mm
2.5 in.	-
3 in.	80 mm
4 in.	100 mm
6 in.	150 mm
8 in.	200 mm
10 in.	250 mm

The nominal size does not refer either to the outside or the inside diameter of the pipe. Pipe thickness affects the ID.

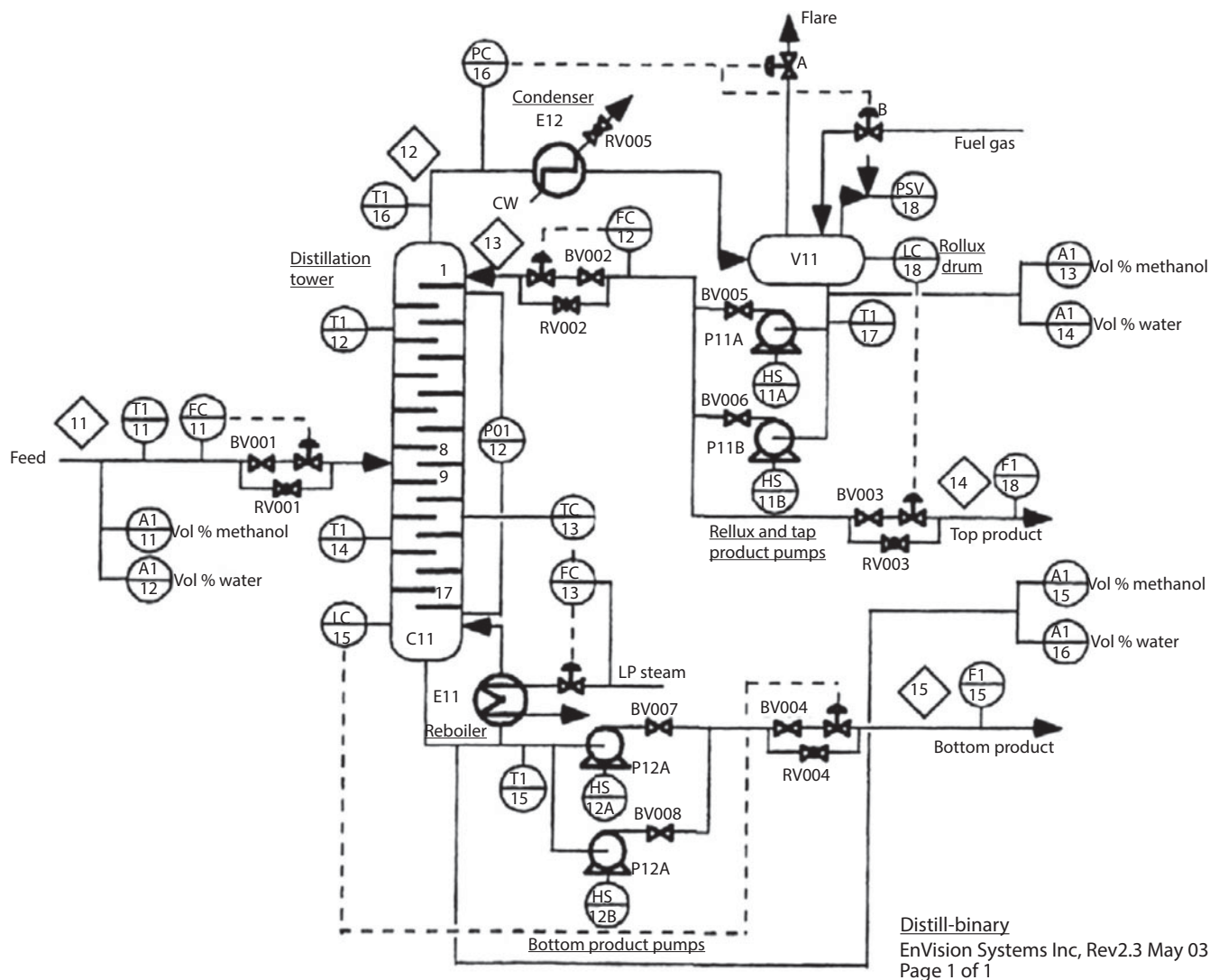


Figure 22 Piping and instrumentation diagram.

Piping and instrumentation diagram (P &ID): A schematic representation of the interconnecting pipelines and control systems for a process or part of a process (see Figure 22). Using a standard set of symbols for process equipment and controllers. It includes the layout of branches, reducers, valves, equipment, instrumentation and control interlocks. They also include process equipment names, numbers; process piping including sizes and identification; valves and their identification; flow directions, instrumentation, and designations; vents, drains, sampling lines, and flush lines. P & IDs are used to operate the process system, operators’ trainings as well as being used in plant maintenance and process modifications. At the design stage, they are useful in carrying out safety and

operations investigations such as Hazop. List of P & ID items are:

- Instrumentation and designations
- Mechanical equipment with names and numbers
- All valves and their identifications
- Process piping, sizes and identification
- Miscellanea – vents, drains, special fittings, sampling lines, reducers, enlargers, and swagers
- Permanent start-up and flush lines
- Flow directions.
- Interconnections references
- Control inputs and outputs, interlocks
- Interfaces for class changes

- Computer control systems
- Identification of components and subsystems.

Polymerization: A reaction in which like molecules are joined together to form dimer and trimer compounds, etc., of the reactant(s). This most often occurs with olefinic compounds in oil refineries. The objective of a polymerization unit is to combine or polymerize the light olefins propylene and butylenes into molecules two or three times their original molecular weight. The feed to this process consists of light gaseous hydrocarbons (C₃ and C₄) produced by catalytic cracking, which are highly unsaturated. The polymer gasoline produced has octane numbers above 90.

PONA Analysis: Analysis for paraffins (P), olefins (O), naphthenes (N), and aromatics (A). Method used is ASTM D 1319.

Pour Point: 1. Is a measure of how easy or difficult to pump the crude oil, especially in cold weather. Specifically, the pour point is the lowest temperature at which a crude oil will flow or pour when it is chilled without disturbance at a controlled rate. The pour point of the whole crude or oil fractions boiling above 450°F (232°C) is determined by the standard test ASTM D97. Both pour and cloud points are important properties of the product streams as far as heavier products are concerned. For heavier products, they are specified in a desired range and this is achieved by blending appropriate amounts of lighter intermediate products. 2. The temperature at which oil starts to solidify and no longer flows freely. Pour point usually occurs 40 to 42°F (4.5 to 5.5°C) below the cloud points. A sample tube of petroleum oil is chilled in the pour point test. The pour point is defined as the temperature at which the sample will still pour (move) when the sample tube is tipped. The pour temperature is typically about 5°F (2.8°C) lower than the cloud point.

Power Stroke: Is the downward motion of a piston that occurs after ignition as the fuel combusts and expands.

ppmv: A volume concentration of a species in a bulk.

Prandtl number (Pr): A dimensionless number, Pr representing the ratio of the momentum of diffusivity to thermal diffusivity in fluid convection.

$$\text{Pr} = \frac{c_p \mu}{k}$$

where c_p is the specific heat, μ is the viscosity, and k is the thermal conduction.

Pre-Ignition: Describes the event when the air/fuel mixture in the cylinder ignites before the spark plug fires. Pre-ignition is initiated by an ignition source other than the spark, such as hot spots in the combustion chamber, a spark plug that runs too hot for the application, or carbonaceous deposits in the combustion chamber heated to incandescence by previous engine combustion events. It is a technically different phenomenon from engine knocking.

The phenomenon is also referred to as 'after-run', or 'run-on' or sometimes dieseling, when it causes the engine to carry on running after the ignition is shut off. This effect is more readily achieved on carbureted gasoline engines, because the fuel supply to the carburetor is typically regulated by a passive mechanical float valve and fuel delivery can feasibly continue until fuel line pressure has been relieved, provided the fuel can be somehow drawn past the throttle plate.

Pre-ignition and engine knock both sharply increase combustion chamber temperatures. Consequently, either effect increases the likelihood of the other effect occurring and both can produce similar effects from the operator's perspective, such as rough engine operation or loss of performance due to operational intervention by a computer. See Knocking.

Pre-Startup Safety Review (PSSR): Audit check performed prior to equipment operation to ensure adequate process safety management (PSM) activities have been performed. The check should verify (1) Construction and equipment is satisfactory, (2) Procedures are available and adequate, (3) A process hazard analysis (PHA) has been undertaken and recommendations resolved, (4) The employees are trained.

Precursor: Compounds which are suitable or susceptible to specific conversion to another compound. e.g., methyl cyclopentane is a good precursor for making benzene in a catalytic reformer.

Preheat, Preheat Train: Heat exchanger or network of heat exchangers in which the feed to a process (usually a distillation column) is heated by recovering heat from products being cooled.

Pressure, Absolute: 1. The force applied over a given area. Instrument gauges used to measure the pressure of fluids are either expressed as absolute pressure, which is measured above a vacuum. 2. Gauge pressure plus barometric or atmospheric pressure. Absolute pressure can be zero only in a perfect vacuum. 3. The pressure

due to the weight of the atmosphere (air and water vapor) on the Earth's surface. The average atmospheric pressure at sea level has been defined as 14.69 lb/in² absolute.

Pressure, Atmospheric: 1. The pressure due to the weight of the atmosphere (air and water vapor) on the Earth's surface. The average atmospheric pressure at sea level is 14.696 lb_f/in². absolute. 2. The pressure exerted by the atmosphere on a given point. It decreases as the elevation above sea level increases.

Pressuring Agent: The hydrocarbon, usually butane used to bring gasoline blends up to an acceptable vapor pressure.

Pressure drop: 1. The decrease in pressure between two points in a system caused by frictional losses of a moving fluid in a pipe or duct, or by some other resistance such as across a packed bed, a filter or catalyst, or due to the effects of hydrostatic head such as across the liquid on the tray of a distillation column. 2. Change in pressure with depth.

Pressure drop multiplier (φ²): A parameter used in two-phase gas-liquid frictional pressure drop calculations where the overall pressure drop along a length of pipe is due to combination from the flowing gas and liquid. This is expressed by:

$$\frac{dp_f}{dz} = \phi_g^2 \left(\frac{dp_g}{dz} \right)_g = \phi_L^2 \left(\frac{dp_L}{dz} \right)_L$$

where φ_g² and φ_L² are the pressure drop multipliers for the liquid and gas phases in which the parameters X² is defined as:

$$X = \sqrt{\frac{\left(\frac{dp_L}{dz} \right)_L}{\left(\frac{dp_g}{dz} \right)_g}} = \left(\frac{\phi_g^2}{\phi_L^2} \right)^{0.5}$$

Correlations have been developed to determine relationships for the multipliers for combinations of laminar and turbulent gas and liquid phases (See Figure 23).

Pressure, Hydrostatic: The pressure, volume per unit area, exerted by a body of water at rest.

Pressure Integrity Test: A pressure test of a vessel formed by the entire well or part of a well. It usually measures the ability of a pressure vessel to hold pressure without leaking at a given pressure.

Pressure, Negative: A pressure less than atmospheric.

Pressure Reducing Valve: Valve used to reduce a high supply pressure to a usable level.

Pressure Relief Valve: A mechanical valve that opens at a preset pressure to relieve pressure in a vessel (See Figure 24).

Primary Absorber: The first absorber in a FCC gas plant.

Pretreatment: Group of processes that natural gas is subjected to prior to its liquefaction. Its purpose is to remove mainstream contaminants or compounds that may cause operational problems in the liquefaction unit.

Pretreatment Facility: Industrial wastewater treatment plant consisting of one or more treatment devices designed to remove sufficient pollutants from wastewaters to allow an industry to comply with effluent limits established by the US EPA General and Categorical Pretreatment Regulations or locally derived prohibited discharge requirements and local effluent limits.

Preventative Maintenance: Maintenance carried out prior to unit or system failure.

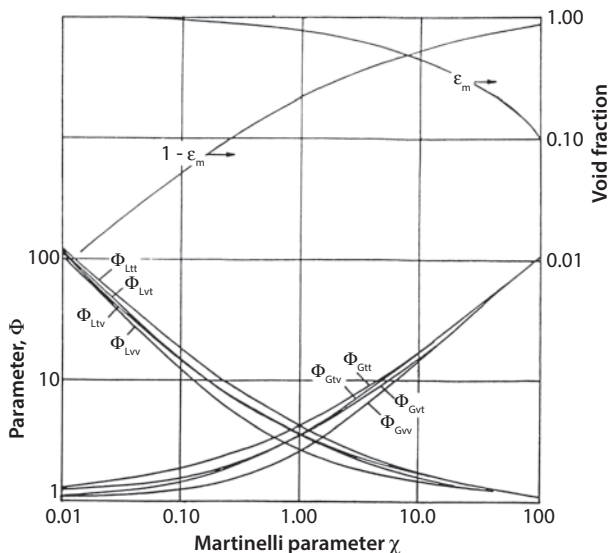


Figure 23 Lockhart-Martinelli two-phase multiplier.

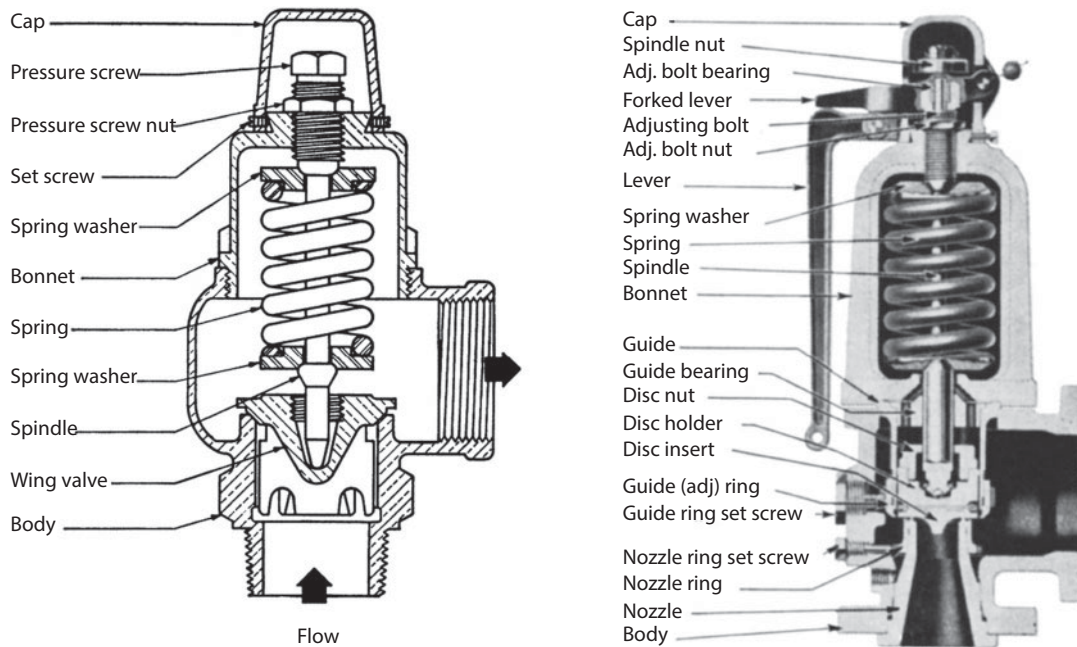


Figure 24 Relief valve Safety valve.

Preventive Maintenance: Regularly scheduled servicing of machinery or other equipment using appropriate tools, tests and lubricants. This type of maintenance can prolong the useful life of equipment and machinery and increase its efficiency by detecting and correcting problems before they cause a breakdown of the equipment.

Probability: The likelihood that the impact or event will occur. Impact (or consequence) is the effect on conditions or people if the hazard is realized (occurs) in practice, and probability is the likelihood that the impact will occur. Risk is a function of probability and impact (consequence). With this discrete data, it is determined by taking the number of occurrences for the particular type of event being considered and dividing that by the total number of outcomes for the event. Expressed as a deterministic value (quantitative single value or high, medium, low, etc.) or as a range of values – that is, uncertainty – that is represented by a probability distribution.

Probability Distribution (Risk): A mathematical relationship between the values and the associated probabilities for a variable across the entire range of possible values for that variable. Typically, probability distributions are displayed as frequency or cumulative frequency plots.

Probability Distillation: The characteristic shape of laboratory distillation boiling curves tends to follow the shape of a normal distribution function, especially the TBP method. Probability distillation paper is constructed with a probability scale for the boiling point scale and laboratory distillation curves may be plotted as straight lines on this paper. This provides a reasonable way to extrapolate partial laboratory distillation data.

Process: Any activity or operation leading to a particular event.

Process Flow Diagram (PFD): A schematic representation of a process or part of a process that converts raw materials to products through the various units operations (Figure 25). It typically uses a symbolic representation for the major items of equipment such as storage vessels, reactors, separators, process piping to and from the equipment, as well as bypass and recirculation lines, and the principal flow routes. Key temperatures and pressures corresponding to normal operation are included, as well as equipment ratings, minimum and maximum operational values. Material flows and compositions are included. It may also include important aspects of control and pumping, as well as any interaction with other process equipment or flows. The design duties or sizes of all the major equipment are also featured, which can collectively provide

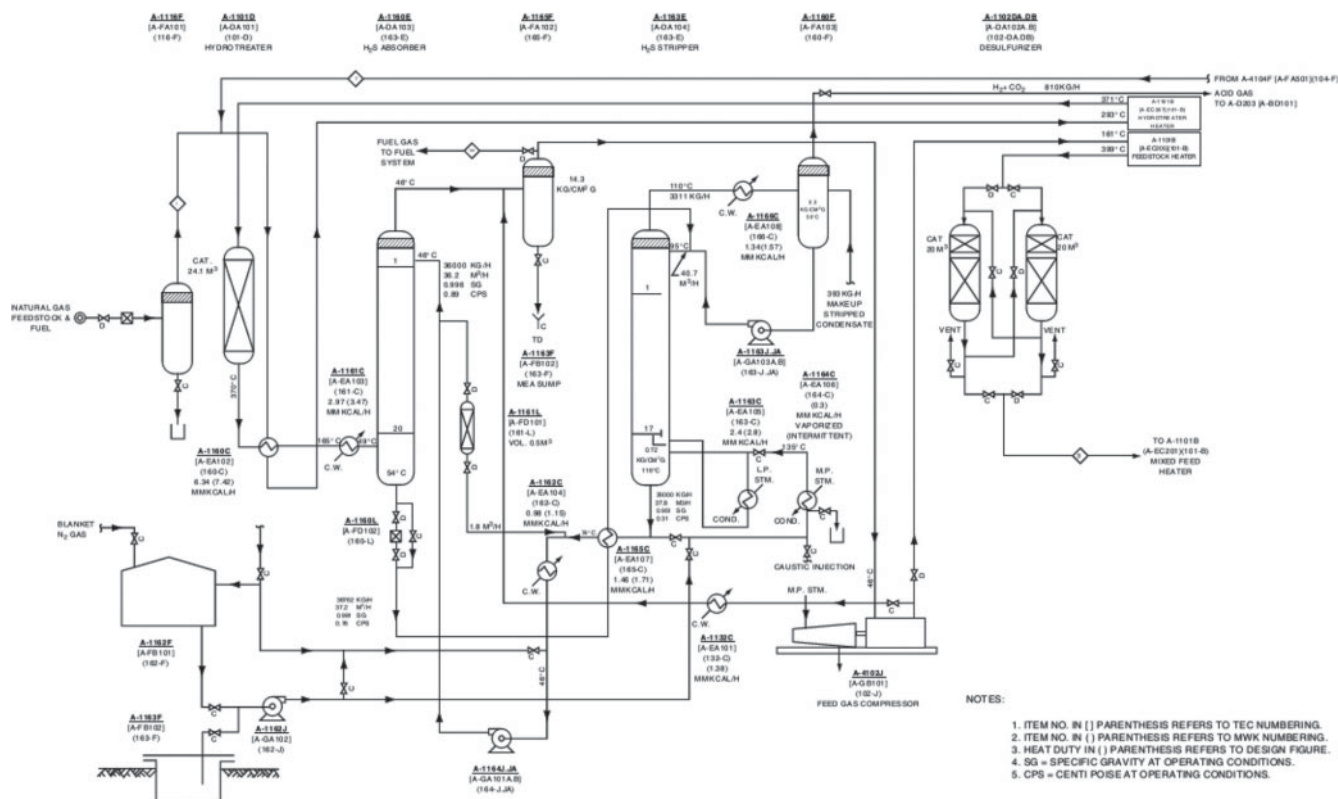


Figure 25 Process flow diagram (Feed and fuel desulfurization section).

a comprehensive representation of the process. PFDs generally do not include the following:

- Pipe classes or piping line numbers
- Process control instrumentation (sensors and final elements).
- Minor bypass lines
- Isolation and shutoff valves.
- Maintenance vents and drains
- Relief and safety valves
- Flanges.

Programmable Logic Controller (PLC): A digital electronic controller that uses computer based programmable memory for implementing operating instructions through digital or analog inputs and outputs.

Process Hazard Analysis (PHA): An organized formal review to identify and evaluate hazards with industrial facilities and operations to enable their safe management. The review normally employs a qualitative technique to identify and assess the importance of hazards as a result of identified consequences and

risks. Conclusions and recommendations are provided for risks that are deemed at a level not acceptable to the organization. Quantitative methods may be also employed to embellish the understanding of the consequences and risks that have been identified.

Process Risk: Risk arising from the process conditions caused by abnormal events (including basic process control system (BPCS) malfunction.

Note: The risk in this context is that associated with the specific hazardous event in which Safety Instrument Systems (SIS) are to be used to provide the necessary risk reduction (i.e., the risk associated with functional safety).

Process Safety Management (PSM): Comprehensive set of plans, policies, procedures, practices, administrative, engineering and operating controls designed to ensure that barriers to major incidents are in place, in use and are effective.

Processing Gain: The volumetric amount by which total output is greater than input for a given period of time. This difference is due to the processing of crude

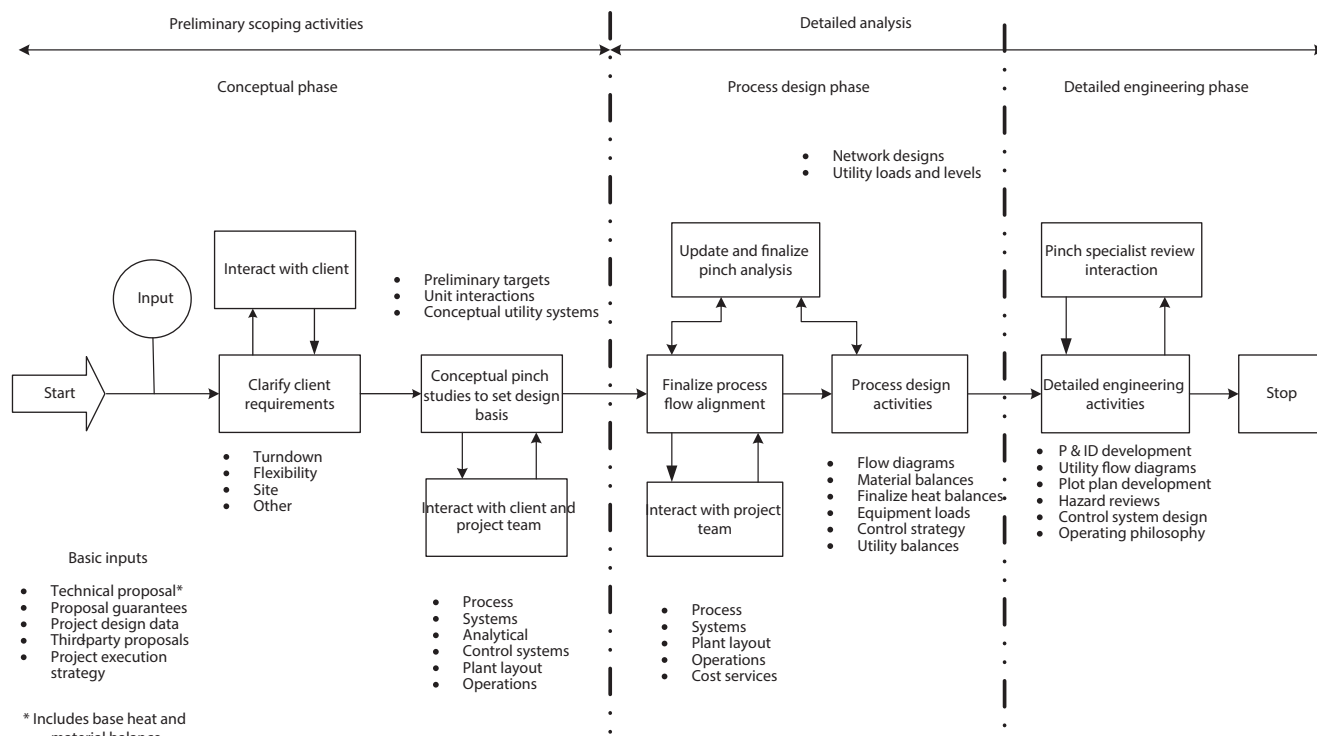


Figure 26 This new process design work process implements process integration effectively. (Source: Stephen W. Morgan, “Use Process Integration to Improve Process Designs and the Design Process”, Chemical Engineering Process, p 62, September 1992 [5]).

oil into products which in total have a lower specific gravity than the crude oil being processed.

Processing Loss: The volumetric amount by which total refinery output is less than input for a given period of time. This difference is due to the process of crude oil into products which in total have a higher specific gravity than the crude oil being processed.

Production Capacity: The maximum amount of product that can be produced from processing facilities.

Products Supplied: 1. Crude Oil: Crude oil burned on leases and by pipelines as fuel. 2. Approximately represents consumption of petroleum products because it measures the disappearance of these products from primary sources, i.e., refineries, natural gas processing plants, blending plants, pipelines, and bulk terminals. In general, product supplied of each product in any given period is computed as follows: field production, plus refinery production, plus imports, plus unaccounted for crude oil (plus net receipts when calculated on a PAD District basis), minus stock change, minus crude oil losses, minus refinery inputs, minus exports.

Propane (C₃H₈): A hydrocarbon gas that is a principal constituent of the heating fuel. LPG. Propane is

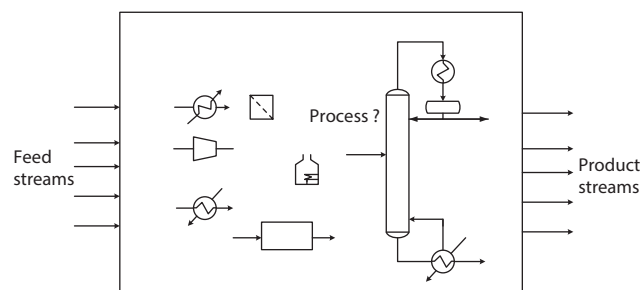


Figure 27 Process integration starts with the synthesis of a process to convert raw materials into desired products.

used extensively for domestic heating and as a feed to ethylene plants.

Propylene (C₃H₆): A hydrocarbon in the olefin series resulting from olefin plant operations and refinery cracking processes and used as alkyl plant feed or chemical feedstock.

Propylene (C₃H₆) (nonfuel use): Propylene that is intended for use in nonfuel applications such as petrochemical manufacturing. Nonfuel use propylene includes chemical-grade propylene, polymer-grade propylene, and trace amounts of propane. Nonfuel use propylene also includes the propylene component of

propane/propylene mixes where the propylene will be separated from the mix in a propane/propylene splitting process. Excluded is the propylene component of propane/propylene mixes where the propylene component of the mix is intended for sale into the fuel market.

Process design: The design of industrial process that uses physical, chemical or bio-chemical transformations for the production of useful products. It is used for the design of new processes, plant modifications, and revamps (Figure 26). It starts with conceptual and feasibility studies, and includes detailed material and energy balances, the production of block flow diagrams (BFDs), process flow diagrams (PFDs), engineering line diagrams (ELDs), and piping and instrumentation diagrams (P & IDs). It also includes the production of reports and document for plant construction, commissioning, start-up, operation and shut-down. The reports and documents are used by vendors, regulatory bodies, operators and other engineering disciplines.

Process economics: An evaluation of a process in terms of all the costs that are involved. It considers the cost of raw materials and how they are processed, as well as the costs associated with waste processing such as recycling or disposal. It also includes the optimization of a process to best utilize materials and energy. The fixed costs of a process are not dependent on the rate of production, but the variable costs are and must be met by the revenue generated by sales. Taxes are deducted resulting in the net profit.

Process engineer: He or she uses the principles of heat and material balances, hydraulics, vapor-liquid equilibrium, and chemistry to solve plant operating problems and optimize operating variables.

Process integration: 1. A holistic approach used in process design that considers the process as a whole with the interactions between unit operations in comparison with the optimization of unit operations separately and independently. It is known as process synthesis (See Figure 27). 2. A technique used to minimize the energy consumption and heat recovery in a process. It is also known as process heat integration and pinch analysis (See Energy Management).

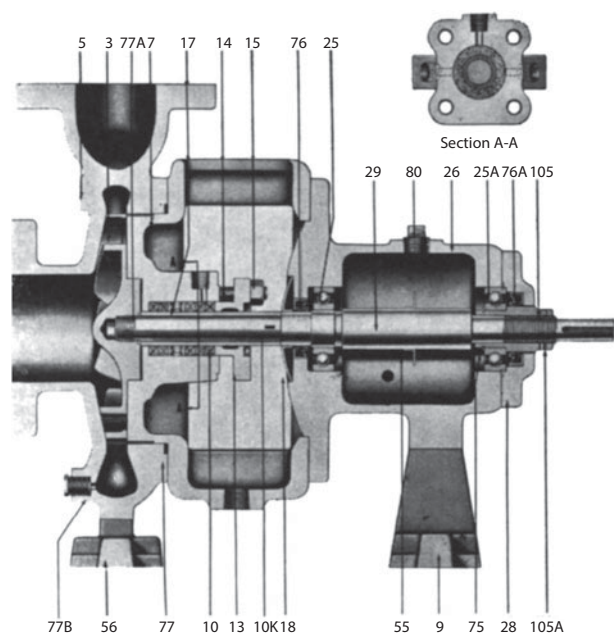
Process intensification: An approach to engineering design, manufacture, and operation of processes that aims to substantially improve process performance through energy efficiency, cost effectiveness, reduction in waste, improvement in purification steps, reduction

of equipment size, increase in safety and operational simplicity. It involves a wide range of innovative reactor, mixing and separation technologies that can result in dramatic improvements in process performance. It involves an integrative approach that considers overall process objectives rather than the separate performance of individual unit operations; process intensification can enable a process to achieve its maximal performance leading to the development of cheaper, smaller, cleaner, safer, and sustainable technologies.

Process plant: A collective name for an industrial facility used to convert raw materials into useful products. It includes all the process equipment such as reactors, mixers and separating units, all the associated pipework and pumps, heat exchangers, and utilities such as steam, and cooling water.

Process safety: A comprehensive management system that focuses on the management and control of potential major hazards that arise from process operations. It aims at reducing risk to a level that is as low as is reasonably practicable by the prevention of fires, explosions, and accidental or unintended chemical releases that can cause harm to human life and to the environment. It includes the prevention of leaks, spills, equipment failure, over and under-pressurization, over-temperatures, corrosion, and metal fatigue. It covers a range of tools and techniques required to ensure safe operation of plant and machinery to ensure the safety of personnel, the environment, and others through detailed design and engineering facilities, maintenance of equipment, use of effective alarms and control points, procedures, and training. It also includes risk assessment, layers of protection analysis and the use of permit to work authorizations.

Process simulation: The use of computers to model and predict the operational and thermodynamic behavior of a process. Commercial software packages are used to simulate and model batch, continuous, steady-state and transient processes. They require combined material and energy balances, the properties of the materials being processed, and sometimes combine the use of experimental data with mathematical descriptions of the process being simulated. Most software packages feature optimization capabilities involving the use of complex cost models and detailed process equipment size models. Some commercial software products are shown in the table below:



3	Impeller	26	Bearing housing
5	Casing	28	Bearing end cover
7	Back head cradle	29	Pump shaft
9	Bearing housing foot	55	Oil disc. (flinger)
10	Shaft sleeve	56	Casing foot
10K	Shaft sleeve key	75	Retaining ring
13	Stuffing box gland	76	Oil seal—front
14	Stuffing box gland stud	76A	Oil seal—rear
15	Stuffing box gland stud Nut	77	Gasket—casing
17	Seal cage	77A	Gasket—sleeve
18	Splash collar	77B	Gasket—drain plug
25	Shaft bearing—radial	80	Oil vent
25A	Shaft bearing—thrust	105	Shaft adjusting sleeve
		105A	Sleeve lock nut

Figure 28 General service centrifugal pump.

Software	Developer	Applications	Website
Aspen Plus/ Aspen Hysys	Aspen Technology	Process simulation and optimization	www.aspentech. com
CHEMCAD	Chemstations	Software suite for process simulation	www.chem stations.com
Design II for Windows	WinSim Inc.	Process simulation	www.winsim. com
gPOMS	PSE Ltd.	Advanced process simulation and Modeling	www. psenterprise. com
PRO II	SimSci	Process simulation	www.software. schneider- electric.com/ simsci
ProSim Plus	ProSim	Process simulation and optimization	www.prosim. net
UniSim	Honeywell	Process simulation and optimization	www.honeywell process.com

Process synthesis: The conceptual design of a process that identifies the best process flowsheet structure, such as the conversion of raw materials into a product(s). This requires the consideration of many alternative designs. The complex structure of most processes is such that the flowsheet is split into smaller parts and each is reviewed in turn. Then choices and decisions are made. Many techniques are used in arriving at the best flowsheet such as those based on total cost, which needs to be minimized. Use is made of graphical methods, heuristics, and various other forms of minimization such as the use of process integration.

Process upset: A sudden, gradual or unintended change in the operational behavior of a process. It may be due to process equipment failure or malfunction, operator intervention, a surge or fall in pressure, flow, level, concentration, etc.

Process variable: A dynamic feature of a process or system that is required to be controlled to ensure that it operates according to design requirements and does not deviate as to be unsafe or result in undesirable consequences. The commonly measured process variables include temperature, pressure, flow, level and concentration.

Pseudo-component: For engineering calculation purposes, a component that represents a specified portion of the TBP distillation curve for a petroleum mixture. The pseudo-component is assigned a normal boiling point and gravity corresponding to the average for the boiling point range. Molecular weight and other properties are derived from the boiling point and gravity using literature correlations for hydrocarbons.

Pump: A mechanical device used to transport a fluid from one place or level to another by imparting energy to the fluid. The three bonds groupings are centrifugal, reciprocating and rotary type pumps. The most commonly used is the centrifugal type, which has a rotating impeller used to increase the velocity of the fluid and where part of the energy is converted to pressure energy. Rotary and reciprocating pumps are positive displacement pumps in which portions of fluid are moved in the pump between the teeth of gears, and by the action of a piston in a cylinder. There are many variations of these types and each has a particular application and suitability for a fluid in terms of its properties, required flow rate and delivery pressure (See Figure 28).

Pumparound: A liquid side-draw from a distillation/fractionating column that is pumped cooled and returned to a higher location in the column. Pumparounds recover useable heat that would be lost at the condenser. They also lower the vapor flow in a column and reduce the required column diameter for vapor loaded columns such as crude and vacuum columns.

Pumpdown: A liquid side draw that is pumped down to a tray below the draw tray, usually the next tray lower. Pumpdowns are sometimes cooled prior to returning to the column.

Pump priming: Used for the start-up and successful operation of centrifugal pumps in which the casing housing the "impeller" is first filled or primed with liquid before operation begins. Since the density of a liquid is many times greater than that of a gas, vapor, or air, the suction pressure is otherwise insufficient to draw in more liquid. Depending on the type of pump, priming can be achieved either manually or by drawing liquid in using a vacuum pump. Valves can be used to prevent drainage, and ensure that the pump does not require priming once the pump stops.

Purge: A stream that is removed from a recycle process to prevent buildup of one or more components in the process streams.

Pyrolysis: 1. Heating a feedstock to high temperature to promote cracking as in an ethylene plant. 2. Destructive distillation that involves decomposition of coal, woody materials, petroleum, and so on, by heating in the absence of air.

Pyrolysis Gasoline: The gasoline created in an ethylene plant cracking gas oil or naphtha feed stocks. Sometimes called pygas, it has high content of aromatics and olefins and some diolefins.

Pyrophoric Iron Sulfide: A substance typically formed inside tanks and processing units by the corrosive interaction of sulfur compounds in the hydrocarbons and the iron and steel in the equipment. On exposure to air (oxygen), it ignites spontaneously.

Quality: The weight fraction of vapor in a vapor-liquid mixture.

Quench: Hitting a very hot stream coming out of a reactor with a cooler stream to stop immediately the reaction runaway.

Quench Crack: A crack in steel resulting from stresses produced during transformation from austenite to martensite.

Quench Hardening: Heat treating requiring austenitization followed by cooling, under conditions that austenite turns into martensite.

Quenching Oil: An oil introduced into high-temperature process streams during refining to cool them.

Quench Stream: A cooled stream that is used to cool another stream by direct contact. For example, hydrogen quench streams are used to quench the hot effluents from hydrocracker reactors.

Quench Zone: A section of a distillation column where a hot stream, usually vapor is cooled by direct contact with a stream that has been cooled, usually a liquid.

Radiant Heat Transfer: Heat transfer without convection or conduction. Sunshine is radiant heat.

Radiation: Transmission of energy by means of electromagnetic waves emitted due to temperature.

Radical: A group of atoms that separate themselves from a compound momentarily and are highly reactive. For example, two methyl radicals $\cdot\text{CH}_3$ can come from cracking an ethane compound, but they will rapidly attach themselves to some other atom or compound.

Raffinate: 1. The leftover from a solvent extraction process. 2. In solvent refining, that portion of the oil that remains undissolved and is not removed by the selective solvent.

Rating Calculations: Calculations in which a unit operation such as a column, heat exchanger, pump, and so on, is checked for capacity restrictions.

Ratio of Specific Heats: 1. Thermodynamic comparison ($k = C_p/C_v$) of the ratio of a specific heat (k) at a constant pressure (C_p) to a specific heat at a constant volume (C_v). The ratio range for most gases is 1.2–1.4. 2. For gases, it is the ratio of the specific heat at constant pressure to the specific heat at constant volume. The ratio is important in thermodynamic equations as compressor horsepower calculations, and is given the symbol k , where $k = C_p/C_v$. The ratio lies between 1.2 and 1.4 for most gases.

Reactor: The vessel in which chemical reactions takes place.

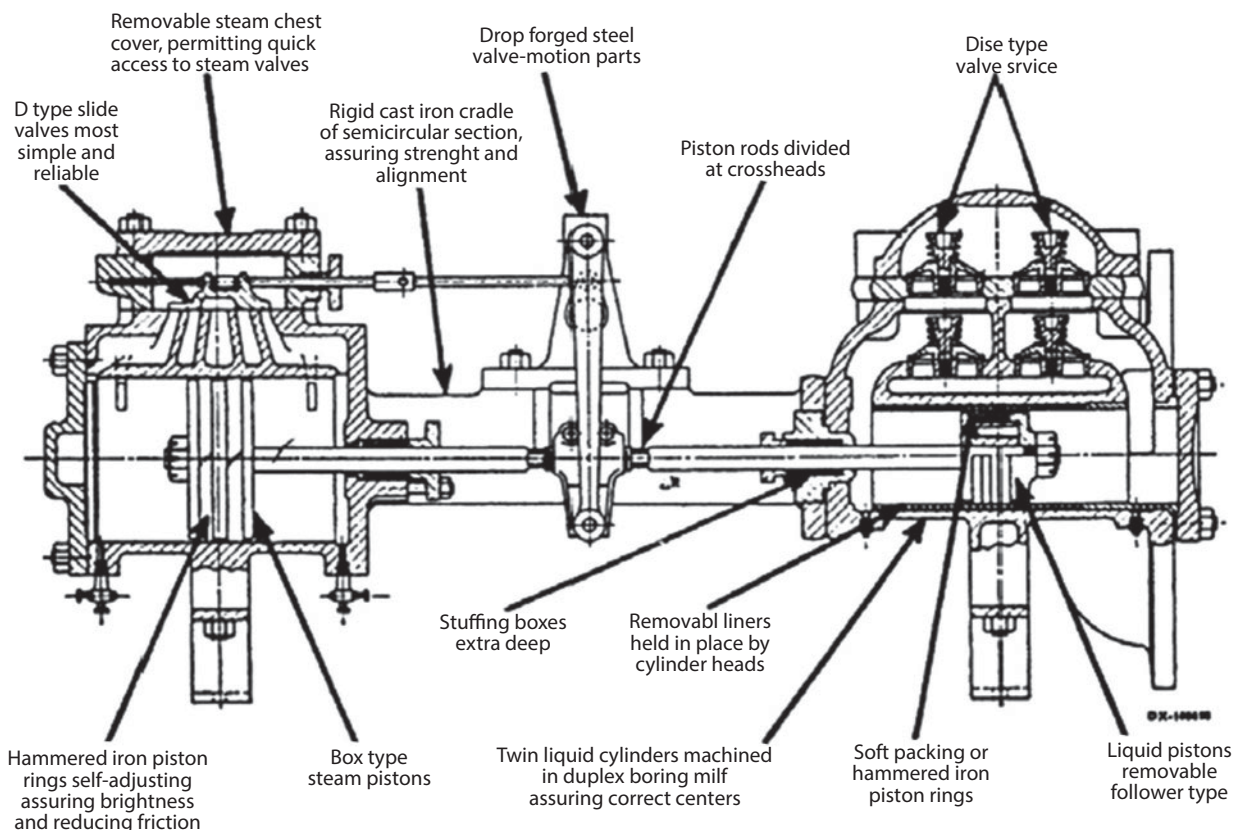


Figure 29 General service duplex steam-driven piston pump.

Reactive Distillation: A distillation column in which there is a section designed for chemical reaction, usually containing a catalyst bed. Some MTBE and TAME processes use a reactive distillation column in place of a second reactor prior to the product separation column.

Reactor Effluent: The outlet stream from a reactor.

Reboiler: 1. A heat exchanger used towards the bottom of a fractionator to reheat or oven vaporize a liquid and introduce it several trays higher to help purify the incoming stream or get more heat into the column. 2. An auxiliary unit of a fractionating tower designed to supply additional heat to the lower portion of the tower.

Reciprocating Pump: 1. A piston pump. 2. A pump with an up-and-down stroke or motion (See Figure 29).

Recovery: Usually refers to the fraction expressed as a percentage of a component or group of components in the feed to a distillation column that are recovered in a given product stream.

Rectification Zone: The portion of a distillation column in which heavy components are washed down the column by contact with a liquid reflux stream. In conventional distillation columns, this is the portion of the column from the tray above the feed tray to the top tray.

Recycle: A process stream that is returned to an upstream operation.

Recycled Feeds: Streams that have been processed and are fed back to the reactors for additional processing.

Reduced Crude: A residual product remaining after the removal by distillation of an appreciable quantity of the more volatile components of crude oil.

Reduced Pressure: The ratio of the absolute pressure to the critical pressure.

Reduced Temperature: The ratio of the absolute temperature to the critical temperature.

Reducing Agent: Any substance, such as base metal (iron) or the sulfide ion, that will readily donate (give up) electrons. The opposite is an oxidizing agent.

Reduction: The addition of hydrogen, removal of oxygen, or the addition of electrons to an element or compound. Under anaerobic conditions (no dissolved oxygen present), sulfur compounds are reduced to odor-producing hydrogen sulfide (H_2S) and other compounds.

Redwood Viscometer: Standard British viscometer. The number of seconds required for 50 ml of oil to flow out of a standard Redwood viscometer at a definite temperature is the Redwood viscosity.

Refinery Grade Butane (C_4H_{10}): A refinery produced stream that is composed predominantly of normal butane and/or isobutane and may also contain propane and/or natural gasoline. These streams may also contain significant levels of olefins and/or fluorides contamination.

Refinery Input, Crude Oil: Total crude oil (domestic plus foreign) input to crude oil distillation units and other refinery processing units (cokers, etc.).

Refined Products: The various hydrocarbons obtained as a result of refining process separation from crude oil. Typical refined products are LPG, naphtha, gasoline, kerosene, jet fuel, home heating oil, diesel fuel, residual fuel oil, lubricants and petroleum coke.

Refiner: A company involved in upgrading hydrocarbons to saleable products.

Refinery: 1. An installation that manufactures finished petroleum products from crude oil, unfinished oils, natural gas liquids, other hydrocarbons and oxygenates. 2. A plant used to separate the various components present in crude oil and convert them into usable fuel products or feedstock for other processes. 3. A large plant composed of many different processing units that are used to convert crude oil into finished or refined products. These processes include heating, fractionating, reforming, cracking and hydrotreating.

Refinery Gas: A non-condensable gas collected in petroleum refineries.

Refinery Input (Crude Oil): Total crude oil (domestic plus foreign) input to crude oil distillation units and other refinery processing units (cokers).

Refinery Input (Total): The raw materials and intermediate materials processed at refineries to produce finished petroleum products. They include crude oil, products of natural gas processing plants, unfinished oils, other hydrocarbons and oxygenates, motor gasoline and aviation gasoline blending components and finished petroleum products.

Refinery Margins: The difference in value between the products produced by a refinery and the value of the crude oil used to produce them. Refining margins will thus vary from refinery to refinery and depend on the price and characteristics of the crude used.

Refinery Production: Petroleum products produced at a refinery or blending plant. Published production of these products equals refinery production minus refinery input. Negative production occurs when the amount of a product produced during the month is less than the amount of that same product that is reprocessed (input) or reclassified to become another product during the same month. Refinery production of unfinished oils and motor and aviation gasoline blending components appear on a net basis under refinery input.

Refinery Yield: Represents the percentage of finished product produced from input of crude oil and net input of unfinished oils (expressed as a percentage). It is calculated by dividing the sum of crude oil and net unfinished input into the individual net production of finished products. Before calculating the yield of finished motor gasoline, the input of natural gas liquids, other hydrocarbons and oxygenates, and net input of motor gasoline blending components must be subtracted from the net production of finished motor gasoline. Before calculating the yield of finished aviation gasoline, input of aviation gasoline blending components must be subtracted from the net production of finished aviation gasoline.

Reflux: 1. Condensed liquid that is returned to the top tray of a distillation column. Reflux helps rectify the mixture being distilled by washing heavy components down the column. 2. The portion of the distillate returned to the fractionating column to assist in attaining better separation into desired fractions.

Reflux drum: A drum that receives the outlet from the overhead condenser from a distillation column. The liquid and vapor portions are separated in the reflux drum.

Reformat: An upgraded naphtha resulting from catalytic or thermal reforming.

Reforming: 1. The mild thermal cracking of naphthas to obtain more volatile products such as olefins, of higher octane values or catalytic conversion of naphthas components to produce higher octane aromatic compounds. 2. A refining process used to change the molecular structure of a naphtha feed derived from

crude oil by distillation. 3. The gasoline produced in a catalytic reforming operation.

Reformulated Fuels: Gasoline, diesel or other fuels that have been modified to reflect environmental concerns, performance standards, government regulations, customer preferences, or new technologies.

Reformed Gasoline: Gasoline made by a reformat process.

Reformulated Gasoline (RFG): 1. A gasoline whose composition has been changed (from that of gasolines sold in 1990) to (a) include oxygenates, (b) reduce the content of olefins and aromatics and volatile components, and (c) reduce the content of heavy hydrocarbons to meet performance specifications for ozone-forming tendency and for release of toxic substances (benzene, formaldehyde, acetaldehyde, 1,3-butadiene, and polycyclic organic matter) into the air from both evaporation and tailpipe emissions. 2. Is a cleaner-burning gasoline that reduces smog and other air pollution. Federal law mandates the sale of reformulated gasoline in metropolitan areas with the worst ozone smog. 3. Finished motor gasoline formulated for use in motor vehicles, the composition and properties of which meet the requirements of the reformulated gasoline regulations promulgated by the U.S. Environmental Protection Agency under Section 211 (k) of the Clean Air Act. NB: This category includes oxygenated fuels program reformulated gasoline (OPRG), but excludes reformulated gasoline blendstock for oxygenate blending (RBOB). (4) Gasoline that meets the requirements imposed by the Clean Air Act Amendment, passed by the United States Congress on November 15, 1990. Restrictions were placed on volatile organic compounds, nitrous oxides (NO_x) from combustion, and toxins primarily related to benzene (C_6H_6) and its derivatives.

Reformulated Gasoline Blendstock for Oxygenate Blending: A motor gasoline blending component that, when blended with a specified type and percentage of oxygenate, meets the definition of reformulated gasoline.

Refrigerant: 1. In a refrigerating system, the medium of heat transfer that picks up heat by evaporating at a low temperature and pressure and gives up heat on condensing at a higher temperature and pressure. 2. It is the fluid that performs an inverse thermodynamic cycle, generating the low temperature required for natural gas cooling and liquefaction.

Refrigerant Compressor: A component of a refrigerating system that increases the pressure of a compressible refrigerant fluid and simultaneously reduces its volume while moving the fluid through the device.

Refrigerating System: A system that, in operation between a heat source (evaporator) and a heat sink (condenser), at two different temperatures, is able to absorb heat from the heat source at the lower temperature and reject heat to the heat sink at the higher temperature.

Refrigeration (or Cooling Cycle): 1. The process used to remove the natural gas liquids by cooling or refrigerating the natural gas until the liquids are condensed out. The plants use Freon or propane to cool the gas. 2. Inverse thermodynamic cycle whose purpose is to transfer heat from a medium at low temperature to a medium at higher temperature.

Regasification: The process by which LNG is heated, converting it into its gaseous state.

Regasification Plant: A plant that accepts deliveries of LNG and vaporizes it back to gaseous form by applying heat so that the gas can be delivered into a pipeline system.

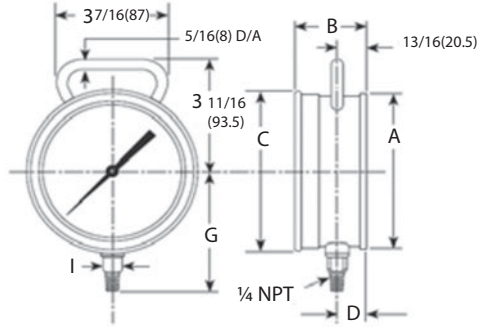
Regenerator: The vessel in a catalytic process where a spent catalyst is cleaned up before being recycled back to the process. An example is the catalytic cracker regenerator where coke deposited on the catalyst is burned off.

Regeneration: 1. The process of burning off coke deposits on catalyst with an oxygen containing gas under carefully controlled conditions. 2. In a catalytic process the reactivation of the catalyst, sometimes done by burning off the coke deposits under carefully controlled conditions of temperature and oxygen content of the regeneration gas stream.

Reid Vapor Pressure (RVP): An ASTM test method to determine the vapor pressure of a light petroleum stream. The Reid vapor pressure is very nearly equal to the true vapor pressure for gasoline streams. There is also a Reid vapor pressure test for crude oil (See Figure 30 and Table 2).

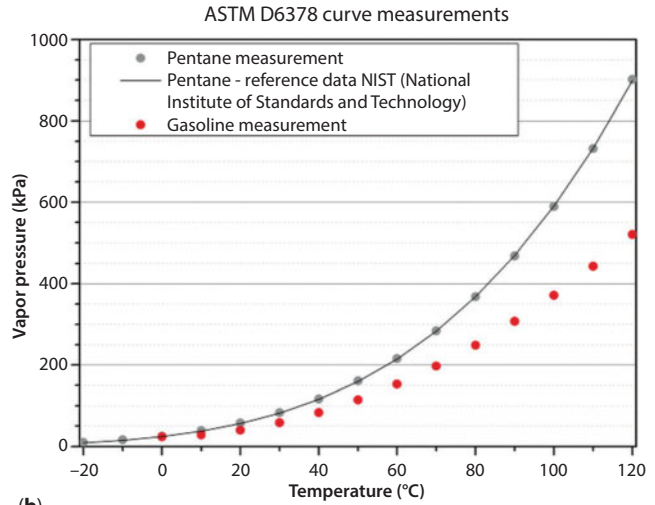
Relative volatility (α): The ratio of the vapor pressure of one liquid component to another in a heterogeneous mixture and is a measure of their separability. For a binary mixture, the relative volatility can be expressed in terms of the mole fraction of the more

Reid vapor test gauge
Type 1150H
4½"
Lower connect (only)

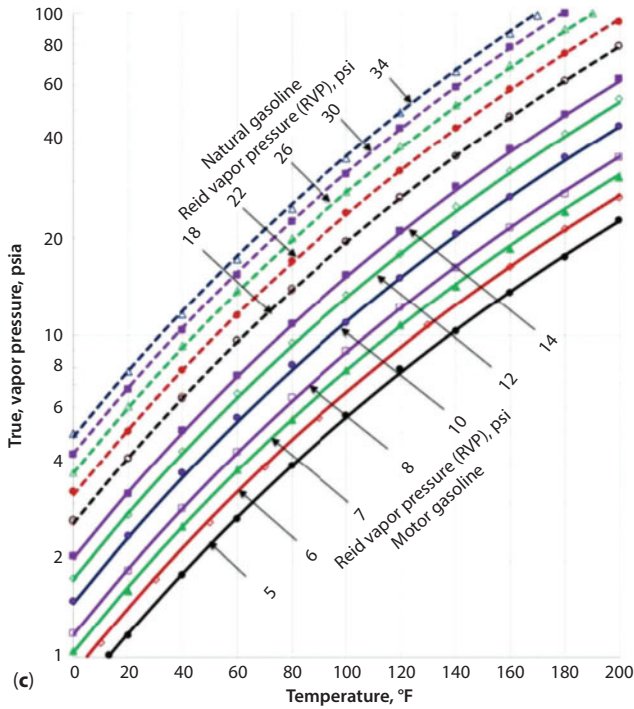


Dial size inches	A	B	C	D	G	I	Wght (lbs)
4½	4 31/32 (127)	2 1/8 (54)	4 7/8 (124)	15/16 (24)	3 13/16 (97)	5/8 (16)	1.7 .8kg

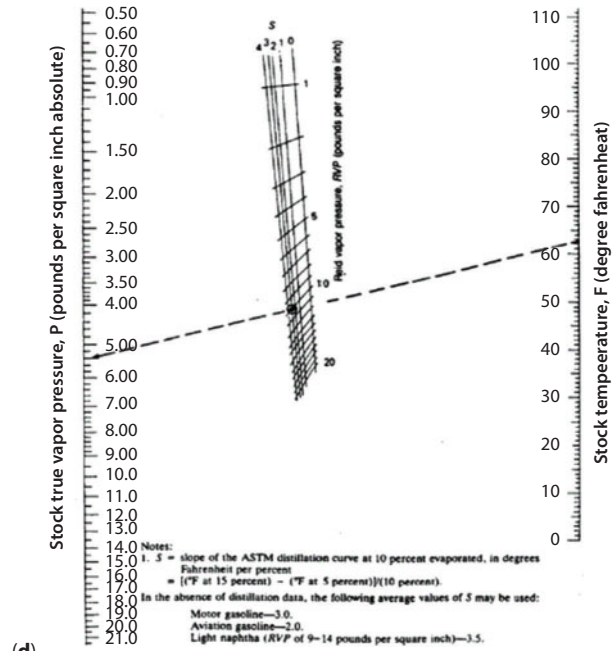
(a) Dimensions in inches (mm)



(b)



(c)



(d)

Figure 30 (a) Reid vapor test gauge (b) Vapor pressure vs. temperature (c) Reid vapor pressure vs. Temperature.

volatile component in the liquid and vapor phases, x and y as:

$$\alpha = \frac{y(1-x)}{x(1-y)}$$

The greater the value of the relative volatility, the greater the degree of separation. If $y = x$, then no separation is possible.

Reliability: The probability that a component or system will perform its defined logic functions under the stated conditions for a defined period of time.

Research Octane Number (RON): One of two standards tests of gasoline knock, this one simulates less severe operating conditions like cruising. It is determined in a special laboratory test engine under mild “engine-severity” conditions, giving a measure of the

Table 2 RVP blending values.

RVP blending values		Vol% (aromatics)					
	rvp (pure HC)	0	10	20	30	40	50
Ethane	730.0	474.0	474.0	474.0	474.0	474.0	474.0
Propene	226.0	216.0	216.0	216.0	216.0	216.0	216.0
Propane	190.0	173.0	173.0	173.0	173.0	173.0	173.0
Isobutane	72.2	62.0	73.9	85.4	96.6	107.6	118.8
Isobutene	63.4	76.5	78.9	81.3	83.7	86.2	88.9
Butene-1	63.0	76.1	78.4	80.8	82.7	85.1	87.4
n-Butane	51.6	52.9	55.6	58.3	60.9	63.5	66.2
trans-2-Butene	49.8	62.1	64.0	66.0	68.0	70.0	72.0
cis-2-Butene	45.5	58.6	60.5	62.3	64.2	66.1	69.0
Isopentane	20.4	21.9	22.2	22.5	22.9	23.3	23.7
C ₅ olefins*	16.5	17.9	18.1	18.4	18.6	18.8	19.0
n-Pentane	15.6	16.9	17.2	17.4	17.8	18.0	18.2

*C₅ olefins in FCC proportion.

low-speed knock properties of a gasoline. Contrast with Motor Octane Number.

Residence time: 1. The amount of time a hydrocarbon spends in a vessel where a reaction occurs. 2. The period of time in which a process stream will be contained within a certain volume or piece of equipment, seconds.

Residual Fuel: heavy fuel oil made from long, short or cracked residue plus whatever cutter stock is necessary to meet market specifications.

Residue: The bottoms from a crude oil distilling unit, vacuum flasher, thermal cracker or visbreaker. See *long residue and short residue*.

Residuum: Residue from crude oil after distilling off all but the heaviest components with a boiling range greater than 1000°F (538°C).

Reynolds Number (Re): A dimensionless number, Re, expressing the ratio of inertial to viscous forces in a flowing fluid, and can be used to determine the flow regime. For a fluid in a pipe of circular cross section:

$$Re = \frac{\rho v d}{\mu}$$

where ρ is the density, v is the mean velocity, d is the diameter of a pipe, and μ is the viscosity. Where the value for critical pipes falls below 2,000 the flow is

laminar flow, or stream line. For Reynolds number above 4,000 the flow is turbulent (See Figure 7).

Rich oil: The absorption oil leaving the bottom tray of an absorption column. The rich oil contains the absorbed light components.

Ring Compounds: Hydrocarbon molecules in which the carbon atoms form at least one closed ring such as naphthenes or aromatics. Also called cyclic.

Ring Structure: A compound in which some of the carbon atoms are linked with other carbon atoms to form a continuum. Carbon atoms attached to the ring carbon atoms are said to be "side chains".

Riser: 1. A pipe through which a fluid travels upwards. 2. Steel or flexible pipe, which transfers well fluids from the seabed to the surface.

Risk: 1. Is defined as a measure of economic loss, human injury, or environmental damage in terms of both the incident likelihood and the magnitude of the loss, injury or damage. 2. The probability of an event happening times the impact of its occurrence on operations. (Impact is the effect on conditions or people if the hazard is realized (occurs) in practice and potentials are the likelihood that the impact will occur.

Likelihood	Catastrophic	Critical	Marginal	Negligible
Certain	Class I	Class I	Class I	Class II
Possible	Class I	Class I	Class II	Class III
Occasional	Class I	Class II	Class III	Class IV
Remote	Class II	Class III	Class III	Class IV
Improbable	Class III	Class III	Class IV	Class IV
Inconceivable	Class IV	Class IV	Class IV	Class IV

Risk Analysis: A decision-making tool that allows examination of the level and significance of work place risk for humans, equipment, weather, operations or other conditions. Determines the probability of risk occurring, the impact the risk will have, and how to mitigate the risk. See *Hazard Analysis*.

Risk Assessment: The process of identifying and evaluating the technical and nontechnical risks associated with a project. It includes the amount or degree of potential danger perceived (by an assessor) when determining a course of action to accomplish a given task. Risk assessment may be qualitative or quantitative.

Risk Matrix: Is the common approach to risk assessment and hazard analysis. Its underlying idea is that acceptability of risk is a product of how likely a thing is to happen, and how bad it would be if it happened. This is shown in the following tables.

Category	Definition	Range (failures per year)
Certain	Many times in system lifetime	$>10^{-3}$
Probable	Several times in system lifetime	10^{-3} to 10^{-4}
Occasional	Once in system lifetime	10^{-4} to 10^{-5}
Remote	Unlikely in system lifetime	10^{-5} to 10^{-6}
Improbable	Very unlikely to occur	10^{-6} to 10^{-7}
Inconceivable	Cannot believe that it could occur	$< 10^{-7}$

Risk matrix categorization of severity of consequences

Category	Definition
Catastrophic	Multiple loss of life
Critical	Loss of a single life
Marginal	Major injuries to one or more person
Negligible	Minor injuries to one or more person

Risk matrix
 Consequence
 Key:
 Class I: Unacceptable
 Class II: Undesirable
 Class III: Tolerable
 Class IV: Acceptable

Road Oil: Any heavy petroleum oil, including residual asphaltic oil used as a dust palliative and surface treatment on roads and highways. It is generally produced in six grades from 0, the most liquid to 5, the most viscous.

Rule of Thumb: Axioms based on practical experience and/or methods to approximate calculated results using simple formulae.

Runback: The liquid returning to the flash zone of a distillation column.

Safety: A general term denoting an acceptable level of risk of, relative freedom from and low probability of harm.

Safeguard: A precautionary measure of stipulation. Usually equipment and/or procedures designed to interfere with incident propagation and/or prevent or reduce incident consequences.

Safety Integrity Level (SIL): 1. Is defined as a relative level of risk reduction provided by a safety function, or to specify a target level of risk reduction. SIL is a measure of performance required for a

safety instrumented function (SIF). 2. The degree of redundancy and independence from the effects of inherent and operational failures and external conditions that may affect system performance.

The requirements for a given SIL are not consistent among all of the functional safety standards. In the European functional safety standards based on the IEC 61508 standard, four SILs are defined, with SIL 4 the most dependable and SIL 1 the least. A SIL is determined based on a number of quantitative factors in combination with qualitative factors such as development process and safety life cycle management.

Assignment of SIL is an exercise in risk analysis where the risk associated with a specific hazard, that is intended to be protected against by a SIF, is calculated without the beneficial risk reduction effect of the SIF. That "unmitigated" risk is then compared against a tolerable risk target. The difference between the "unmitigated" risk and the tolerable risk, if the "unmitigated" risk is higher than tolerable, must be addressed through risk reduction of the SIF. This amount of required risk reduction is correlated with the SIL target. In essence, each order of magnitude of risk reduction that is required correlates with an increase in one of the required SIL numbers.

There are several methods used to assign a SIL. These are normally used in combination, and may include:

- Risk matrices
- Risk graphs
- Layers Of Protection Analysis (LOPA)

Of the methods presented above, LOPA is by far the most commonly used by large industrial facilities.

The assignment may be tested using both pragmatic and controllability approaches, applying guidance on SIL assignment published by the UK HSE. SIL assignment processes that use the HSE guidance to ratify assignments developed from Risk Matrices have been certified to meet IEC EN 61508.

Safety Instrumented Function (SIF): Safety function with a specific safety integrity level which is necessary to achieve functional safety and which can be either a safety instrumented protection function or a safety instrumented control function.

Salt Content: Crude oil usually contains salts in solution in water that is emulsified with the crude. The salt content is expressed as the solution of sodium chloride (NaCl) equivalent in pounds per thousand barrels (PTB) of crude oil. Typical values range from

1 to 20 PTB. Although there is no simple conversion from PTB to parts per million by weight (ppm), 1 PTB is roughly equivalent to 3 ppm.

Saturated Compounds: Hydrocarbons in which there are no double bonds between carbon atoms. Saturated compounds contain the maximum number of hydrogen atoms that are possible.

Screwed Fittings: These are used to assemble screwed connections and field instruments on pipes. They are:

- Pipe thread fittings
- Instrument or tubing fittings
- Metric fittings

None of these will screw together.

Scrub: Removal of components (gas, liquids, or solids) from the methane achieved by surface equipment (scrubbers).

Scrubber: 1. A reactor that removes various components from produced gas. 2. Equipment that causes the separation of liquid and gaseous phases in a fluid system. The separation is usually based on density, differences of the two phases and can take place using gravity force, induced centrifugal force, and so on. 3. System to reduce noxious substances from a flowing stream of air, usually filled with plates or packing, through which scrubbing fluid flows countercurrent or cross-current to the path of the contaminated air.

Scrubbing: Purification of a gas or liquid by washing it in a tower.

Secondary Absorber: The second absorber in a FCC gas plant. It is usually the last unit operation in the gas recovery plant and is also known as the sponge absorber.

Selectivity: The difference between the research octane number and the motor octane number of a given gasoline. Alkylate is an excellent low-sensitivity and reformate a high-sensitivity gasoline component. It is an indication of the sensitivity of the fuel to driving conditions (city vs. highway).

Selective Treating: Preferential removal of one acid gas component, leaving at least some of the other acid gas components in the treated stream.

Sensitivity: The difference in the research octane (F -1) and the motor octane (F -2) for a gasoline stream.

Since research octane is always larger, sensitivity is always a positive number.

Separation zone: A section of a distillation column in which a separation between two products occurs. Components which are found in both products are said to be distributed components.

Separator: Usually refers to a drum, in which the residence time is provided for a mixture of the liquid and vapor to separate into liquid and vapor streams. Also called a flash drum. The liquid and vapor leaving the separator are in phase equilibrium.

Severity: The degree of intensity of the operating conditions of a process unit. Severity may be indicated by clear research octane number of the product (reformer), percentage disappearance of the feed (catalytic cracking), or operating conditions alone (usually the temperature; the higher the temperature, the greater the severity).

Shale: 1. A common sedimentary rock with porosity but little matrix permeability. Shales are one of the petroleum source rocks. Shales usually consist of particles finer than sand grade (less than 0.0625 mm) and include both silt and clay grade material. 2. A very fine-grained sedimentary rock formed by the consolidation and compression of clay, silt or mud. It has a finely laminated or layered structure. Shale breaks easily into thin parallel layers; a thinly laminated siltstone, mudstone, or claystone. Shale is soft but sufficiently hard packed (indurated), so as not to disintegrate upon becoming wet. Some shales absorb water and swell considerably causing problems in well drilling. Most shales are compacted and consequently do not contain commercial

quantities of oil and gas. 3. Rock formed from clay. 4. Gas reserves found in unusually nonporous rock, requiring special drilling and completion techniques.

Shale Gas: Methane (CH₄) gas stored in shale. May be in the pore space, adsorbed to the mineral or rock surfaces, or as free gas in the natural fractures.

Shale Oil: 1. Can be either an immature oil phase, often called kerogen, or actual oil in the cracks or pores of shale. 2. The liquid obtained from the destructive distillation of oil shale. Further processing is required to convert it into products similar to petroleum oils.

Shear force: An applied force to a material that acts in a direction that is parallel to a plane rather than perpendicular. A material such as a solid or fluid is deformed by the application of a shear force over a surface known as the shear stress. The shear strain is the extent of the deformation defined as the ratio of the deformed distance with length. The shear modulus is the ratio of the shear stress to the shear strain.

Shear rate (γ): The deformation of a fluid under the influence of an applied shear force presented as the change in velocity of the fluid perpendicular to flow.

$$\gamma = \frac{dv}{dz}$$

where, dv/dz is referred to as the velocity gradient. The S.I. unit is s⁻¹.

Shear stress (τ): The shear force applied to a fluid that is applied over a surface. When the shear stress is proportional to the shear rate, the fluid exhibits

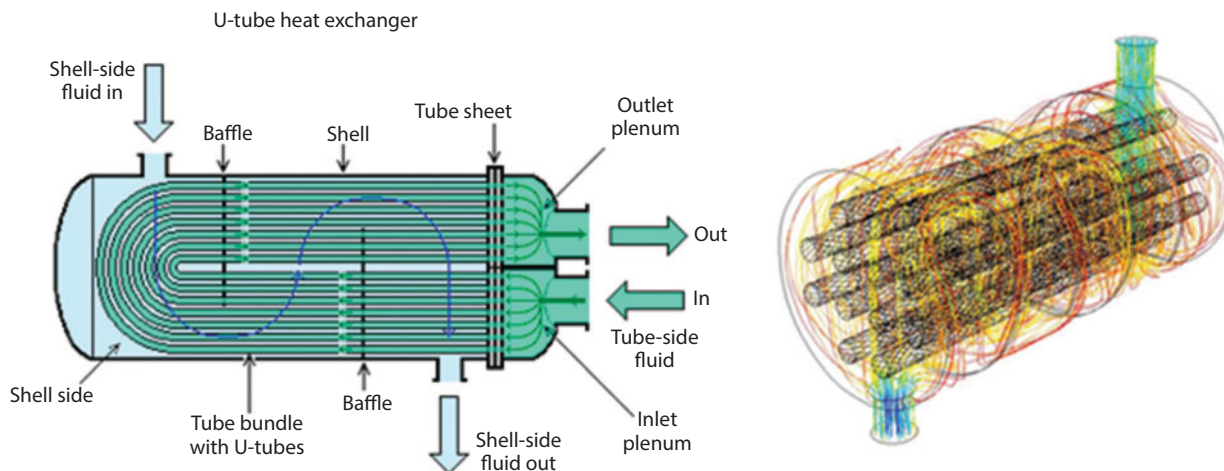


Figure 31 A shell and tube heat exchanger showing the direction of flow of fluids in the shell and tube sides.

Newtonian behavior and the viscosity is constant. The S.I. units are Nm^{-2} .

$$\tau = \mu \frac{dv}{dz}$$

where μ is the viscosity.

Shell and Tube Heat Exchanger: A device used to transfer heat from one medium to another. It consists of a shell that contains tubes. One medium is contained within the shell and the other within the tubes, and heat is transferred from one to the other across the tubes. There are many designs commonly used and the simplest is a single-phase type exchanger in which a cold liquid to be heated flows through the tubes from one side of the exchanger to the other. Steam is used as the heating medium and enters as vapor and leaves as condensate from the bottom. A kettle reboiler type is a type of shell and tube heat exchanger in which steam is admitted through the tubes. The choice of hot or cold fluid in the tubes or shell depends on the application and nature of the fluids, such as their susceptibility to fouling (See Figure 31).

Shell side: The space between the outside of the tubes and the inside of the casing or shell of a shell and tube heat exchanger.

Sherwood number (Sh): A dimensionless number that represents the relationship between mass diffusivity and molecular diffusivity.

$$Sh = \frac{kL}{D_{AB}}$$

Where k is the mass transfer coefficient, L is the characteristic dimension, and D is the diffusivity of the solute A in the solvent B . It corresponds to the Nusselt number used in heat transfer.

Shock wave: A pressure wave of very high pressure intensity and high temperature that is formed when a fluid flows supersonically or in which a projectile moves supersonically through a stationary fluid. It can be formed by a violent event such as a bomb blast or an explosion. A shock-wave compression is the non-isentropic adiabatic compression in waves that is traveling above the speed of sound.

Short Residue: Flasher bottoms or residue from the vacuum tower bottoms.

Short-Term Exposure Limit (STEL): The time-weighted average concentration of a substance over a 15 min. period thought not to be injurious to health.

Shutdown: 1. The status of a process that is not currently in operation due to schedule or unscheduled maintenance, cleaning or failure. 2. A systematic sequence of action that is needed to stop a process safely.

Side draw: See Draw

Side Heater (reboiler): A heat input to a distillation column that is located above the bottom tray of the column.

Side reaction: A chemical reaction that takes place at the same time as a main reaction and produces unwanted products and therefore reduces the yield of the desired product. E.g., in the high temperature cracking

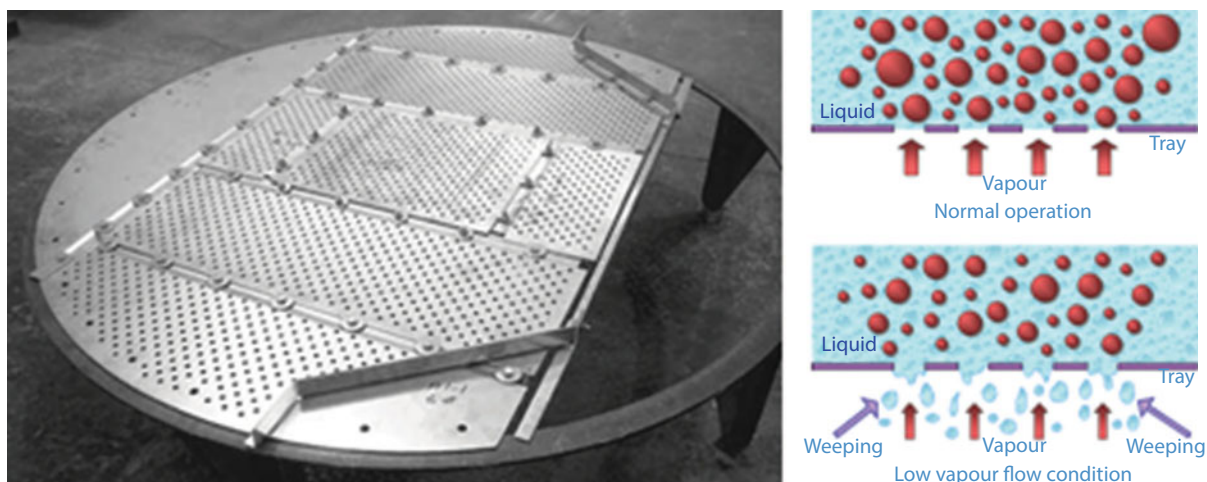


Figure 32 A sieve plate.

reaction of propane (C_3H_8) to produce propylene (C_3H_6), $C_3H_8 \rightarrow C_3H_6 + H_2$, some of the hydrogen can react with the propane to produce methane and ethane as side reactions, $C_3H_8 + H_2 \rightarrow CH_4 + C_2H_6$. The conditions for the reaction must therefore be controlled to reduce this unwanted reaction.

Side stream: The continuous removal of a liquid or a vapor from a process such as a distillation column that is not the main process flow. For example, drawing off vapor or liquid mid way up the column can have economic advantage in terms of the physical size of the column and the amount of boil-up energy required.

Side Stripper: A small auxiliary column that receives a liquid draw product from a main distillation column for stripping of light components. Light components are stripped by stripping steam or reboiling and returned to the main column. Liquid products are sometimes stripped in side strippers to raise the flash point.

Sieve plate column: 1. A type of distillation column that uses a stack of perforated plates to enhance the distribution and intimate contact between vapor and liquid. The plates allow vapor to pass up and bubble through the liquid on the plates. The rate of flow of vapor is sufficient to prevent the liquid from draining down the sieve plates. Instead, the liquid flows over a weir and down a downcomer to the sieve plate below. 2. Sieve trays are metal plates with holes; vapor passes straight through the liquid on the plate. The arrangement, number and size of the holes are design parameters (See Figure 32).

Simulated distillation (Simdist): A relatively new laboratory technique in which a petroleum stream is separated into fractions with gas phase chromatography. Carbon disulfide (C_2S) is used as the carrying agent to dissolve the petroleum stream. The component fractions elute from the chromatographic column in a time sequence, related to their boiling temperatures. Temperatures are assigned to the fractions based on the chromatographic separation of a normal paraffin standard mixture. The simulated distillation approaches a true boiling point distillation, and is reported on a mass basis for streams heavier than gasoline. Aromatic compounds elute from the column faster than paraffin of similar boiling points. Therefore, simulated distillations must be corrected for aromatic content when stocks contain significant quantities of aromatic components.

Slack Wax: Wax produced in the dewaxing of lube oil base stocks. This wax still contains some oil and must be oiled to produce finished wax product.

Slop Wax: The over flash from a vacuum column. The slop wax is usually withdrawn from the column and combined with the fresh charge to the vacuum furnace.

Slurry: The bottom stream from FCC main fractionators. It is termed slurry because it contains suspended catalyst particles.

Slurry Oil: The oil, from the bottoms of the FCC unit fractionating tower, containing FCC catalyst particles carried over by the vapor from the reactor cyclones. The remainder of the FCC bottoms is the decanted oil.

Smoke: The gaseous products of the burning of carbonaceous materials made visible by the presence of small particles of carbon; the small particles that are of liquid and solid consistencies are produced as a byproduct of insufficient air supplies to a combustion process.

Smoke Point: 1. Refers to the height of a smokeless flame of fuel in millimeters beyond which smoking takes place. It reflects the burning quality of kerosene and jet fuels. 2. A test measuring the burning quality of jet fuels, kerosene and illuminating oils. It is defined as the height of the flame in millimeters beyond which smoking takes place; ASTM D 1322.

Soaker, Soaking Drum: A soaker is a device that allows cracking time (soaking time) for heated oil in a thermal cracking operation. Furnace coils and/or drums are used for this purpose. Since some coke is deposited in the soaking device it must be periodically taken off line and cleaned. Furnace coils are much easier to clean than drums.

Soave-Redlich-Kwong (SRK) equation of state: An equation of state widely used to predict the vapor-liquid equilibria of substances. It is a development of the "Redlich-Kwong" equation of state that correlated the vapor pressure of normal fluids.

$$p = \frac{RT}{v-b} - \frac{a a(T)}{V(V+b)}$$

where a and b are constants and obtained from critical point data. It also involves a function that was

developed to fit vapor pressure data using reduced temperature, T_r :

$$a = \left[1 + \left(0.480 + 1.574\omega - 0.176\omega^2 \right) \left(1 - T_r^{0.5} \right) \right]^2$$

where ω is the acentric factor.

Solvent Extraction: A separation process based on selective solubility, where a liquid solvent is introduced at the top of a column. As it passes the feed, which enters near the bottom as a vapor, it selectively dissolves a target constituent. The solvent is then removed via the bottom of the column and put through an easy solvent/extract fractionation. From the top of the column comes a raffinate stream, the feed stripped out of the extract. Butadienes and aromatics are some products recovered by solvent extraction.

Sour Crude Oils: Crudes that contain sulfur in amounts greater than 0.5 to 1.0 wt %, or that contain 0.05 ft³ or more hydrogen sulfide (H₂S) per 100 gal. Such oils are dangerously toxic. Even 0.05 ft³ per 100 gal can be present before severe corrosion tends to occur. Arabian crudes are high-sulfur crudes that are not always considered sour because they do not contain highly active sulfur compounds. Original definition was for any crude oil that smelled like rotten eggs.

Sour Gas: 1. A light gas stream that contains acid gases, in particular sulfur compounds, ammonia compounds, and carbon dioxide. 2. Gas rich in hydrogen sulfide (H₂S). 3. Natural gas that contains significant amount of hydrogen sulfide (usually greater than 16 ppm) and possibly other objectionable sulfur compounds (mercaptans, carbonyl sulfide). Also called "acid gas." 4. Natural or associated gas with high sulfur content. 5. Natural gas containing chemical impurities, a notable hydrogen sulfide (H₂S) or other sulfur compounds that make it extremely harmful to breathe even small amounts; a gas with disagreeable odor resembling that of rotten eggs. 6. A gas containing sulfur-bearing compounds such as hydrogen sulfide and mercaptans and usually corrosive. 7. Raw natural gas to be processed, that is, gas received at the liquefaction plant before being subjected to any pretreatment.

Space Velocity: A unit generally used for expressing the relationship between feed rate and reactor volume in a flow process. It is defined as the volume or weight of feed per unit time per unit volume of reactor or per unit weight of catalyst. Space velocity is normally expressed on a volume basis (LHSV: liquid hourly space velocity)

or a weight basis (WHSV: weight hourly space velocity). LHSV and WHSV are determined as follows:

$$\text{LHSV} = \frac{\text{total volumetric feed flow rate to the reactor}}{\text{total catalyst volume}} [=] h^{-1}$$

$$\text{WHSV} = \frac{\text{total mass feed flow rate to the reactor}}{\text{total catalyst weight}} [=] h^{-1}$$

LHSV and WHSV are related by the equation

$$\text{WHSV} = \frac{\rho_{\text{oil}}}{\rho_{\text{cat}}} \text{LHSV}$$

where ρ_{oil} and ρ_{cat} are the densities of the hydrocarbon feed and the catalyst respectively

Specific gravity: By definition is the ratio of gas density (at the temperature and pressure of the gas) to the density of dry air (at the air temperature and pressure).

Spent Catalyst: Catalyst that has been through a reaction and is no longer as active because of substances or other contaminants deposited on it (in the case of solid) or mixed with it (in the case of liquid).

Spillback: A spillback allows fluid to recycle from the discharge back to the suction of a machine. It's one way to stop a centrifugal compressor from surging.

Splitter: A distillation column that separates a feed into light and heavy products.

Sponge Absorber: See *Secondary absorber*.

Sponge Oil: The liquid used in an absorption plant to soak up the constituent to be extracted.

Stability: Is the ability of a catalyst to maintain its activity and selectivity over a reasonable period. A catalyst with good stability has a long cycle life between regeneration in a commercial unit.

Stabilization: A process for separating the gaseous and more volatile liquid hydrocarbons from crude petroleum or gasoline and leaving a stable (less-volatile) liquid so that it can be handled or stored with less change in composition.

Stabilizer: A distillation column that removes light components from a liquid product. This terminology is often used to describe debutanizer columns that remove C₄ hydrocarbons from gasoline to control the vapor pressure.

Standard cubic feet (scf): The volume of gas expressed as standard cubic feet. Standard conditions in petroleum and natural gas usage refer to a pressure

base of 14.696 psia (101.5 kPa) and a temperature base of 60°F (15°C).

Static head: The potential energy of a liquid expressed in head form:

$$h = \frac{p}{\rho g}$$

where p is the pressure, ρ is the density and g is the acceleration due to gravity. It is used directly in the Bernoulli equation for which the other two head forms are velocity head and pressure head (See Figure 3).

Steady State: Describes a process in which the mass and energy flowing both into and out the process are in perfect balance.

Steam: The gaseous form of water formed when water boils. At atmospheric pressure, steam is produced at 212°F (100°C) by boiling water. It is widely used in the chemical and process industries as a utility for heating processes such as a kettle type reboiler for distillation columns. It is also used in power generation when steam is produced or raised from a thermal process and expanded through turbines. Other uses of steam at destroying harmful pathogens and is a harmless substance once cooled. Wet steam is water vapor that contains water droplets. With further heating, the water evaporates. The **dryness fraction** of steam is the ratio of the amount of water in steam to the total amount of water vapor. Superheated steam is produced by heating the steam above the boiling point of water. The thermodynamic properties of steam are presented in published literature as the steam tables.

Steam (Purchased): Steam, purchased for use by a refinery that was not generated from within the refinery complex.

Steam Cracking: 1. The high temperature reduction in length or cracking of long-chain hydrocarbons in the presence of steam to produce shorter-chain products such as ethylene (C₂H₄), propylene (C₃H₆) and other small-chain alkenes (C_nH_{2n}). 2. The same as catalytic cracking, but specifically referring to the steam injected with the catalyst and feed to give the mixture lift up the riser.

Steam distillation: The separation of immiscible organic liquids by distillation using steam. It involves the injection of live steam into the bottom of the distillation column and into the heated mixture for separation. The steam reduces the partial pressure of the mixture and reduces the temperature required for

vaporization. When distilled, the components operate independently of one another, with each being in equilibrium with its own vapor. Steam distillation is used in the primary separation of crude distillation in a fractionating column.

Steam injection: The use of live steam fed directly into a process to provide water and heat and to

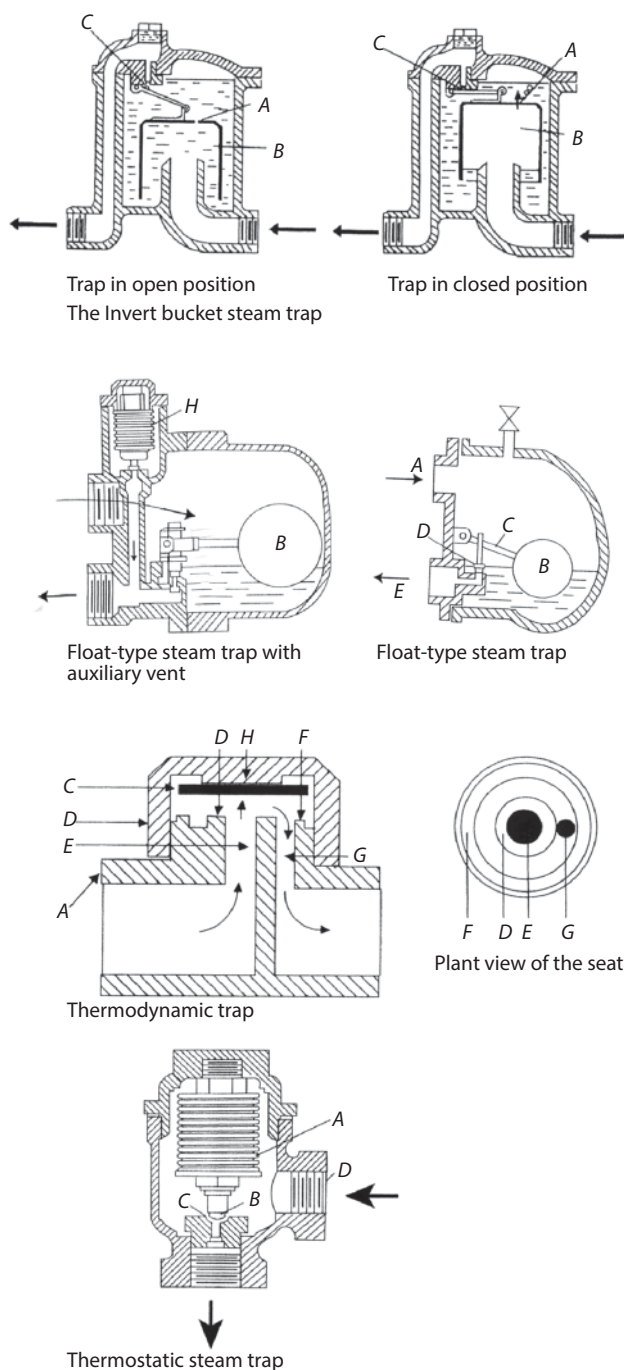


Figure 33

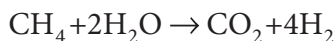
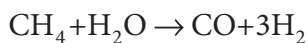
enhance either reaction or extraction. It is commonly used as an enhanced oil recovery method to recover oil from depleted reservoirs or from oil sands in which viscous heavy oil is recovered using steam injection to reduce the viscosity of the oil, and aid transport and recovery. Steam is also directly used in the separation of crude oil and fed to the bottom of the fractionating/distillation column. This is the primary separation of crude oil into fractions that have different boiling points. Steam cracking uses steam for thermal cracking and reforming of hydrocarbons.

Steam jet ejector: A type of fixed operating pump that uses high-pressure steam passed through a constriction to create a low pressure due to the venture effect, and to which the equipment to be evacuated is connected such as a distillation column condenser. In spite of requiring high-pressure steam, the device has no moving parts and therefore has low maintenance costs. It can handle corrosive vapors.

Steam Methane Reformer: A primary source of hydrogen in a refinery, this operating unit converts methane (CH_4) and steam (H_2O) to hydrogen (H_2) with by-products of carbon monoxide (CO) and carbon dioxide (CO_2).

Steam point: The temperature that corresponds to the maximum vapor pressure of water at standard atmospheric pressure (1.01325 bar). This corresponds to a temperature of 100°C .

Steam reforming: The conversion of methane (CH_4) from natural gas into hydrogen (H_2). It is used in production of ammonia (NH_3) in which the methane is first produced from desulfurized and scrubbed natural gas, mixed with steam and passed over nickel catalyst packed in tubes at a high temperature of round 1652°F (990°C)



The reactions are endothermic (i.e., absorbing heat).

Steam tables: Published tables that present thermodynamic data for enthalpy, entropy and specific volume of steam at various temperatures and pressure. Steam is a commonly encountered material in chemical processes and its properties have been extensively tabulated.

Steam tracing: An internal pipe or tube used in process vessels and pipelines carrying steam to provide

adequate heating to a fluid to keep it at a controlled temperature. The amount of steam or heat supplied is sufficient to overcome losses. Steam tracing is typically used in pipelines carrying molten bitumen and other fluids prone to solidification on cooling, to ensure that they remain in a liquid state.

Steam trap: A device used to automatically drain and remove condensate from steam lines to protect the steam main from condensate build-up. Various types of steam traps are used and generally consists of a valve that can be operated by a float, spring or bellows arrangement. Discharge of the hot condensate may be either to the environment or into a collection pipe and returned to the boiler for reuse (See Figure 33).

Still Gas (Refinery gas): Any form or mixture of gases produced in refineries by distillation, cracking, reforming, and other processes. The principal constituents are methane (CH_4), ethane (C_2H_6), ethylene (C_2H_4), normal butane (nC_4H_{10}), butylenes (C_4H_8), propane (C_3H_8), propylene (C_3H_6), and so on. Still gas is used as a refinery fuel and a petrochemical feedstock. The conversion factor is 6 million Btu per fuel oil equivalent barrel.

Stoichiometric: Applied to reactors in which the reactants and products are defined in terms of the molar quantities reacting. E.g., in the reaction: $3\text{H}_2 + 2\text{N}_2 \rightleftharpoons 2\text{NH}_3$, the stoichiometric coefficients are -3.0, -2.0 and 2.0 for the H_2 , N_2 and NH_3 respectively.

Straight Run Distillate or Natural Gasoline: 1. A fraction obtained on simple distillation of crude oil without cracking. Its octane number is usually low and thus requires upgrading by catalytic reforming. 2. A product that has been distilled from crude oil but has not been through a process in which the composition has been chemically altered. 3. Gasoline produced by the primary distillation of crude oil. It contains no cracked, polymerized, alkylated, reformed, or visbroken stock.

Stress Relief: Coded vessels typically have a metal stamp attached that states "Do not weld, stress relieved". That means the vessel has been postweld heat treated to remove stresses in the vessel wall created by welding during fabrication.

Stripper Column: A loose designation applied to a distillation column in which light components are stripped from a heavier liquid product.

Stripping: The removal (by steam-induced vaporization or flash evaporation) of the more volatile components from a cut or fraction.

Stripping Steam: Steam that is injected into the bottom of a side stripping column or used to strip oil from catalyst in a FCC operation.

Stripping Zone: The section of the column in which light components are stripped from a heavier liquid product. In conventional distillation columns, this is the portion of the column from the reboiler to the feed tray.

Sulfolane ($(\text{CH}_2)_4\text{SO}_2$): A chemical used as a solvent in extraction and extractive distillation processes.

Sulfur: A yellowish nonmetallic element, sometimes known as “brimstone.” It is present at various levels of concentration in many fossil fuels whose combustion releases sulfur compounds that are considered harmful to the environment. Some of the most commonly used fossil fuels are categorized according to their sulfur content, with lower sulfur fuels usually selling at a higher price. Note: No. 2 Distillate fuel is currently reported as having either a 0.05% or lower sulfur level for on-highway vehicle use or a greater than 0.05% sulfur level for off-highway use, home heating oil, and commercial and industrial uses. This also includes Ultra Low Sulfur Diesel (< 15 ppm sulfur). Residual fuel, regardless of use, is classified as having either no more than 1% sulfur or greater than 1% sulfur. Coal is also classified as being low-sulfur at concentration of 1% or less or high-sulfur at concentrations greater than 1%.

Sulfuric acid treating: A refining process in which unfinished petroleum products such as gasoline, kerosene, and lubricating oil stocks are treated with sulfuric acid to improve their color, odor, and other characteristics.

Sulfurization: Combining sulfur compounds with petroleum lubricants.

Sulfur content: Is expressed as a percentage of sulfur by weight, and varies from less than 0.1% to greater than 5%. Crude oils with less than 1 wt% sulfur are called low-sulfur content or sweet crude, and those with more than 1 wt% sulfur are called high-sulfur or sour crude. Sulfur-containing constituents of the crude oil include simple mercaptans (also known as thiols), sulfides and polycyclic sulfides. Mercaptan sulfur is simply an alkyl chain (R-) with SH group attached to

it at the end. The simplest form of R – SH is methyl mercaptan, CH_3SH .

Surface Area: The total area that a solid catalyst exposes to the feeds in a reaction. Surface area is enhanced in some catalysts like zeolites by extensive microscopic pores.

Supply: The components of petroleum supply are field production, refinery production, imports, and net receipts when calculated on a PADD basis.

Surge: This a terrifying sound that centrifugal compressors make when they malfunction either due to low flow or excessive discharge pressure or low molecular weight gas.

Sweet Crude: 1. Crude oil containing very little sulfur and having a good odor. 2. Crude petroleum containing little sulfur with no offensive odor. 3. Gets its name due to a pleasant and “sweet” smell. Sweet crude has sulfur content less than 1%. It is more valuable than sour crude because it costs less to process the crude into finished products. 4. Oil containing little or no sulfur, especially little or no hydrogen sulfide. Original definition was for any crude oil that did not have bad odor.

Sweetening: 1. The removal or conversion to innocuous substances of sulfur compounds in a petroleum product by any of a number of processes (doctor treating, caustic and water washing, etc.). 2. Processes that either remove obnoxious sulfur compounds (primarily hydrogen sulfide, mercaptans, and thiophens) from petroleum fractions or streams, or convert them, as in the case of mercaptans, to odorless disulfides to improve odor, color, and oxidation stability.

Sweet Gas: 1. Gas sweetened. Gas processed in the acid gas removal unit that no longer contains these gaseous pollutants. 2. Natural gas that contains small amounts of hydrogen sulfide (and other sulfur compounds), and carbon dioxide that it can be transported or used without purifying with no deleterious effect on piping and equipment. 3. A gas stream from which the sulfur compounds have been removed. 4. A gas containing no corrosive components such as hydrogen sulfide and mercaptans.

Symbols of chemical apparatus and equipment: Below are listed some symbols of chemical apparatus and equipment normally used in a P&ID, according to ISO 10628 and ISO 14617 (See Figure 34).



Figure 34 Symbols of chemical apparatus and equipment.

Synthetic Crude: Wide boiling range product of catalytic cracking, coking, hydrocracking, or some other chemical structure change operation.

Synthesis Gas: The product of a reforming operation in which a hydrocarbon usually methane and water are chemically rearranged to produce carbon monoxide, carbon dioxide and hydrogen. The composition of the product stream can be varied to fit the needs of hydrogen and carbon monoxide at refineries or chemical plant. Also known as syn gas.

Tail Ends: Small amounts of hydrocarbon in a cut that vaporizes slightly outside the effective initial boiling point and the effective end point.

Tail Gas: Light gases C₁ to C₃ and H₂ produced as by-products of refinery processing.

TAN: Total acid number.

Tank Farm: An installation used by gathering and trunk pipeline companies, crude oil producers and terminal operators (except refineries) to store crude oil.

Tanker and Barge: Vessels that transport crude oil or petroleum products. Data are reported for movements between PAD Districts; from a PAD District to the Panama Canal; or from the Panama Canal to a PAD District.

Tar: Complex, large molecules of predominantly carbon with some hydrogen and miscellaneous other

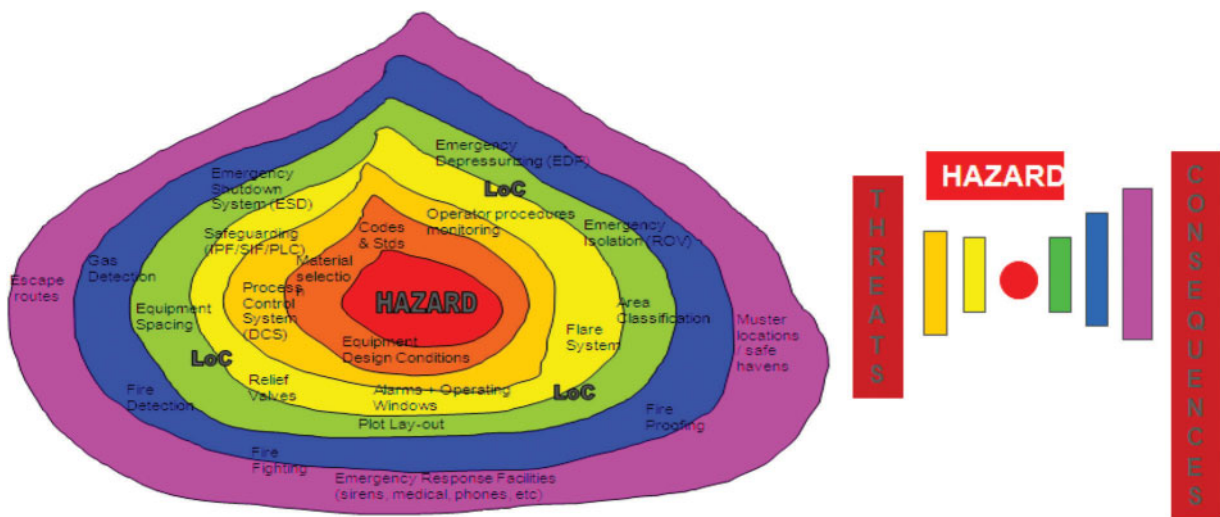


Figure 35 The Onion model (LOC = Loss of containment).

elements that generally deteriorate the quality of processes and the apparatus.

TBP distillation: See *fifteen-five distillation*.

Tertiary Amyl Methyl Ether (CH₃)₂(C₂H₅)COCH₃ (TAME): A high-octane oxygenate blending stock produced by reacting isoamylene (isopentylene) produced in FCC processes with methanol. Used to enhance the octane of a motor gasoline pool.

Tertiary Butyl Alcohol – (CH₃)₃COH (TBA): An alcohol primarily used as a chemical feedstock, a solvent or feedstock for isobutylene production for MTBE; produced as a co-product of propylene oxide production or by direct hydration of isobutylene.

Tetra Ethyl Lead (TEL): A compound added to gasoline to increase the octane. TEL has been superseded by other octane enhancers and is no longer used by refiners for motor gasoline.

Test run: A time period during which operating data and stream samples are collected for a process. During test runs, the operation of the processing unit is held as steady as possible. For good test runs, the average conditions and streams flows approximate at steady-state operation.

The diesel engine: The diesel engine is a reciprocating internal combustion engine. It is different from the petrol engine in that the air intake in the engine cylinder is unthrottled and not premixed with the fuel. Here, the ignition takes place spontaneously without the help of a spark plug. The air taken into the cylinder at atmospheric pressure is compressed to a volume ratio somewhere near to 1:16. At the end of the compression, fuel is injected into the cylinder. The quantity injected depends on the power of the engine, and the heat of compression heats the mass of the air compressed.

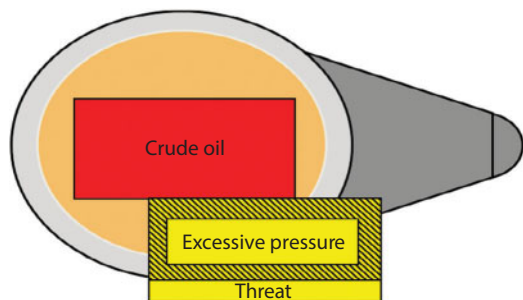


Figure 36 A threat.

The Onion Model: The onion model depicts hazards, barriers and recovery measures. It reflects the layers of protection and shows how the various measures fit together when viewed from the perspective of the hazard. The first layer is the basic containment of our feedstock, processes and products (See Figure 35).

The Saybolt Universal Viscometer: Measures the time in seconds that would be required for the total flow of 60cc of oil from a container tube at a given constant temperature through a calibrated orifice placed at the bottom of the tube. Lubricant viscosities are usually measured in Saybolt Universal seconds at 100°F (37.8°C), 130°F (54.4°C) or 210°F (98.9°C).

E.g., the symbol SSU 100 represents the time in seconds that a fluid at 100°F (37.8°C) will take to flow through a given orifice of the Saybolt viscometer.

Kinematic viscosity can be converted to Saybolt viscosity SSU by the formula:

$$\text{Kinematic viscosity, } \nu = \frac{\mu}{\rho} = 0.219t - \frac{149.7}{t}$$

where

μ = viscosity of fluid in centipoises, cP

ρ = density of fluid, g/cc

t = Saybolt Universal viscosity, sec.

Theoretical Plate: 1. A theoretical contacting unit useful in distillation, absorption, and extraction calculations. Vapor and liquid leaving any such unit are required to be in equilibrium under the conditions of temperature and pressure that apply. An actual fractionator tray or plate is generally less effective than a theoretical plate. The ratio of a number of theoretical plates required to perform a given distillation separation to the number of actual plates used given the overall tray efficiency of the fractionator. 2. Refers to vapor/liquid contact device (e.g., distillation column) in which the liquid and vapor leaving the device are in perfect vapor/liquid phase equilibrium. There are also

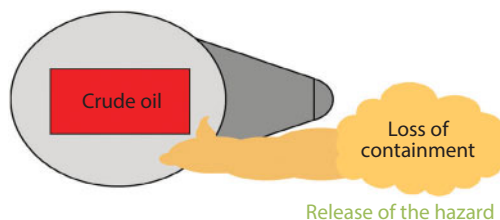


Figure 37 Top event.

perfect energy and mass balances for a theoretical tray (See Figure 5).

Thermal Cracking: 1. A refining process in which heat and pressure are used to break down, rearrange, or combine hydrocarbon molecules. Thermal cracking includes gas oil, visbreaking, fluid coking, delayed coking and other thermal cracking processes (e.g., Flexicoking). 2. The first cracking process, in which the oil was cracked by heating only. Thermal cracking produces lower octane gasoline than catalytic processes.

Thermal Cracked Distillate: Is formed when a distillate heavier than gasoline is heated under pressure in order to break the heavy molecules into lighter ones that boil in the gasoline range. This is superseded by catalytic cracking which gives better distillate.

Thermal Conductivity: The ability of a material to let heat pass. Metals, water and materials that are good conductors of electricity have a high thermal conductivity. Air, rubber, and materials that are bad conductors of electricity have a low thermal conductivity. High viscosity hydrocarbons are bad conductors of heat.

Thermal expansion: Railroad tracks grow longer in the heat of the sun. The hot tubes in an exchanger grow more than the cold shell. Hence, we have a floating head in the tube bundle to accommodate differential rates of thermal expansion between the tube bundle and the shell.

Threat: A threat is something that can cause the release of a hazard and lead to a top event (See Figure 36).

Three phase: A mixture consisting of one vapor in equilibrium with two mutually insoluble liquid phases.

Threshold Limit Value: The amount of a contaminant to which a person can have repeated exposure for an eight-hour day without adverse effects.

Tolerable: Minimum requirements/criteria that have to be met for managing a risk.

Toluene (C₆H₅CH₃): 1. Colorless liquid of the aromatic group of petroleum hydrocarbons, made by the catalytic reforming of petroleum naphthas containing methyl cyclohexane (CH₃C₆H₁₁). A high-octane gasoline blending agent, solvent and chemical intermediate, base for TNT. 2. One of the aromatic compounds used as a chemical feedstock most notoriously for the manufacture of TNT, trinitrotoluene.

Top Event: A top event is the 'release' of the hazard, i.e., the first consequence, typically a loss of containment, a loss of control, or an exposure to something that may cause harm, such as the release of hydrocarbons, toxic substances or energy (See Figure 37).

Top Product: For columns with condensers, the liquid and/or vapor streams from the reflux drum that exit the process.

Topping: Removal by distillation of the light products and transportation fuel products from crude oil, leaving in the still bottoms all of the components with boiling ranges greater than diesel fuel.

Topped Crude Oil: 1. Crude that has been run through a distilling unit to remove the gas oil and lighter streams. The long residue is sold as residual fuel. 2. The bottom product from a crude distillation column.

Toxic Compounds: NO_x, VOCs and SO_x are toxic compounds such as formaldehyde, oxides of nitrogen, volatile organic compounds such as pentene and oxides of sulfur.

Tray: A liquid/vapor contact device in a distillation column (See Figure 5).

Tray Efficiency: See overall tray efficiency

Treat Gas: Light gases, usually high in hydrogen content, which are required for refinery hydrotreating processes such as hydrodesulfurization. The treat gas for hydrodesulfurization is usually the tail gas from catalytic reforming or the product from a hydrogen unit.

Trip: 1. The fast shutdown of an item of chemical plant or process equipment such as a pump or compressor. The shutdown is the result of a process condition being exceeded such as an abnormal flow, pressure, temperature or concentration, etc. 2. This is a safety device that automatically shuts down a piece of equipment. It's a fail-safe mechanism often activated by unlatching a spring operated valve, which then closes.

Troubleshooting: A form of problem-solving methodology used to identify, solve and eliminate problems within a process that has failed or has the potential to fail. It is a logical and systematic search for the source or cause of the problem and solutions presented to ensure that the process is restored back to its full operability. Troubleshooting is applied once a problem has occurred and the process stops functioning. It can take the form of a systematic checklist and

requires critical thinking. Computer techniques are employed for more complex systems where a sequential approach is either too lengthy or not practical or where the interaction between the elements in the system is not obvious.

True Boiling Point distillation (TBP): 1. Of a crude oil or petroleum fractions results from using the U.S. Bureau of Mines Hempel method and the ASTM D – 285 test procedure. Neither of these methods specifies the number of theoretical stages or the molar reflux ratio used in the distillation. Consequently, there is a trend toward applying a 15:5 distillation according to ASTM D2892, instead of the TBP. The 15:5 distillation uses 15 theoretical stages and a molar reflux ratio of 5. 2. A laboratory test in which petroleum oil is distilled in a column having at least 15 theoretical trays and a reflux ratio of 5.0. The distillate is continually removed and further analyzed. The separation corresponds somewhat to a component by component separation and is a good measure of the true composition for the sample being distilled. As the temperatures in the still increase, the pressure of the still is lowered to suppress thermal cracking of the sample.

The minimum pressure for most TBP stills is about 38 mm Hg. This allows distillation of petroleum components boiling up to about 900–950°F (483–510°C) at a pressure of one atmosphere. Surprisingly, the TBP test has never been standardized and several different apparatuses are used for the test.

A key result from a distillation test is the boiling point curve, i.e., the boiling point of the oil fraction versus the fraction of oil vaporized. The initial boiling point (IBP) is defined as the temperature at which the first drop of liquid leaves the condenser tube of the distillation apparatus. The final boiling point or the end point (EP) is the highest temperature recorded in the test.

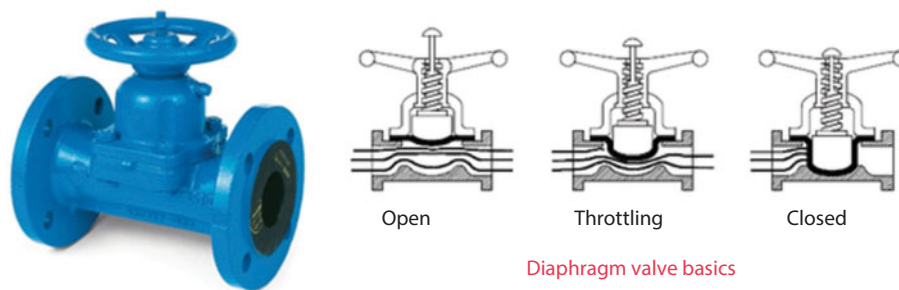
Additionally, oil fractions tend to decompose or crack at a temperature of approximately 650°F (344°C) at one atmosphere. Thus, the pressure of TBP distillation is gradually reduced to as low as 40 mmHg, as this temperature is approached to avoid cracking the sample and distorting measurements of true components in the oil (See Figure 12).

Tube bundle: Pipes in a shell and tube heat exchanger that are packed into an arrangement to ensure effective heat transfer from the outer surface and good transport for fluids through the tubes. The tubes in the tube bundle are spaced and typically set with a rectangular or triangular pitch, and held and sealed with a tube plate. Baffles also provide rigidity and encourage turbulent flow of fluids through the shell side. The tubes can be a straight single-pass or hairpin double-pass arrangement. The tube bundle can be removed from the shell for periodic cleaning. Lugs are welded to the baffles for lifting purposes (See Figure 31).

Tube size: Tubing sizes are entirely different from pipe sizes. Tubing is often used in heat exchangers and fired equipment.

Tube still: See *pipe still*.

Turbine: 1. A machine used to generate electricity by the expansion of a gas or vapor at high pressure through a set of blades attached to a rotor. The blades rotate as the result of the expansion and conversion of energy. Gas turbines and steam turbines are commonly used to generate electricity. A nozzle is used to direct the high-speed gas or steam over a row of turbine blades. The fluid pushes the blades forwards causing them to rotate due to change in momentum. A row of stationary blades within the turbine redirects the fluid in the correct direction again before it passes through another set of nozzles and expands to a lower pressure. A steam turbine may have several pressure sections and



Diaphragm valve basics

Figure 38 A diaphragm valve.

operate at high pressure, medium pressure, and as the steam expands, a low-pressure section all linked to the same shaft. The steam in the medium-pressure section may be returned to a boiler and reheated before doing further work to prevent the formation of water in the turbine. 2. A turbine uses steam pressure or burning gas to drive pumps and compressors at variable speeds. Motor drives are usually fixed-speed machines. Variable speed is an energy efficient way to control flows by eliminating the downstream control valve.

Turbulent flow: A fluid flow regime characterized by the fluctuating motion and erratic paths of particles. In pipes of circular cross-section, this occurs at Reynolds number in excess of 4000. Turbulent flow occurs when inertial forces predominate resulting macroscopic mixing of the fluid.

Turnaround: A planned complete shutdown of an entire process or section of a refinery, or of an entire refinery to perform major maintenance, overhaul, and repair operations and to inspect, test, and replace process materials and equipment.

Two phase: A mixture consisting of one vapor in equilibrium with one homogeneous liquid phase.

ULSD: Ultra-Low-sulfur diesel. Diesel fuel with < 15 ppm sulfur.

Unaccounted for Crude Oil: Represents the arithmetic difference between the calculated supply and the calculated disposition of crude oil. The calculated supply is the sum of crude oil production plus imports

minus changes in crude oil stocks. The calculated disposition of crude oil is the sum of crude oil input to refineries, crude oil exports, crude oil burned as fuel, and crude oil losses.

Undistributed Component: A component in a distillation column separation zone that is totally recovered in only one of the products.

Unfinished Oils: All oils requiring further processing, except those requiring only mechanical blending. Unfinished oils are produced by partial refining of crude oil and include naphthas and lighter oils, kerosene and light gas oils, heavy gas oils, and residuum.

Unfractionated Streams: Mixtures of unsegregated natural gas liquid components excluding, those plant condensate. This product is extracted from natural gas.

Unsaturated Compounds: Hydrocarbon compounds in which some of the carbon atoms have multiple bonds with other carbon atoms because of the lack of hydrogen atoms to satisfy the carbon atoms valences.

Upper Explosive Limit (UEL): The maximum concentration of vapor in air above which the propagation of flame will not occur in the presence of an ignition source. Also referred to as the upper flammable limit or the upper explosion limit.

Utilities: Most plants have some of the following utility systems connected to process units.

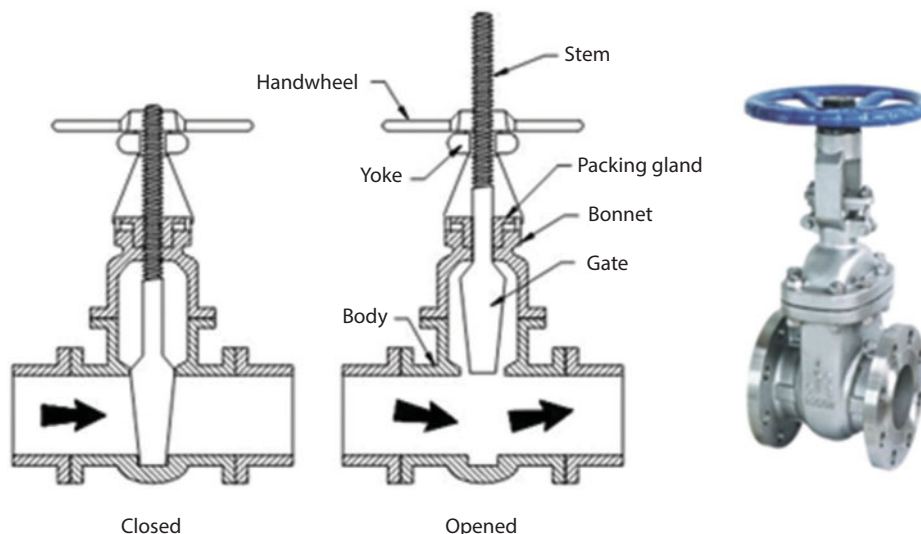


Figure 39 A gate valve.

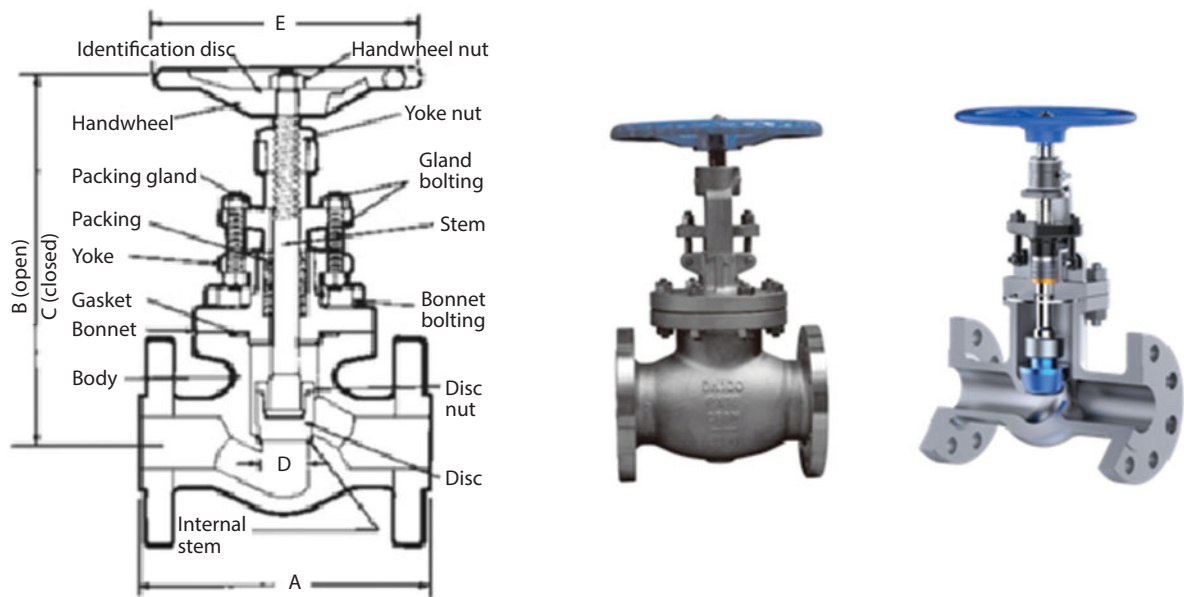


Figure 40 A globe valve away section of a globe valve.



Figure 41 Plug valves Cutaway section of a plug valve.

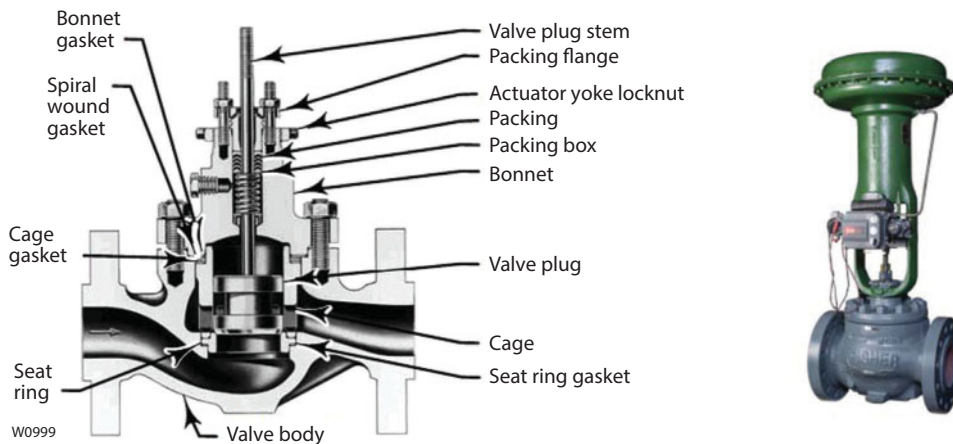


Figure 42 A Control valve.

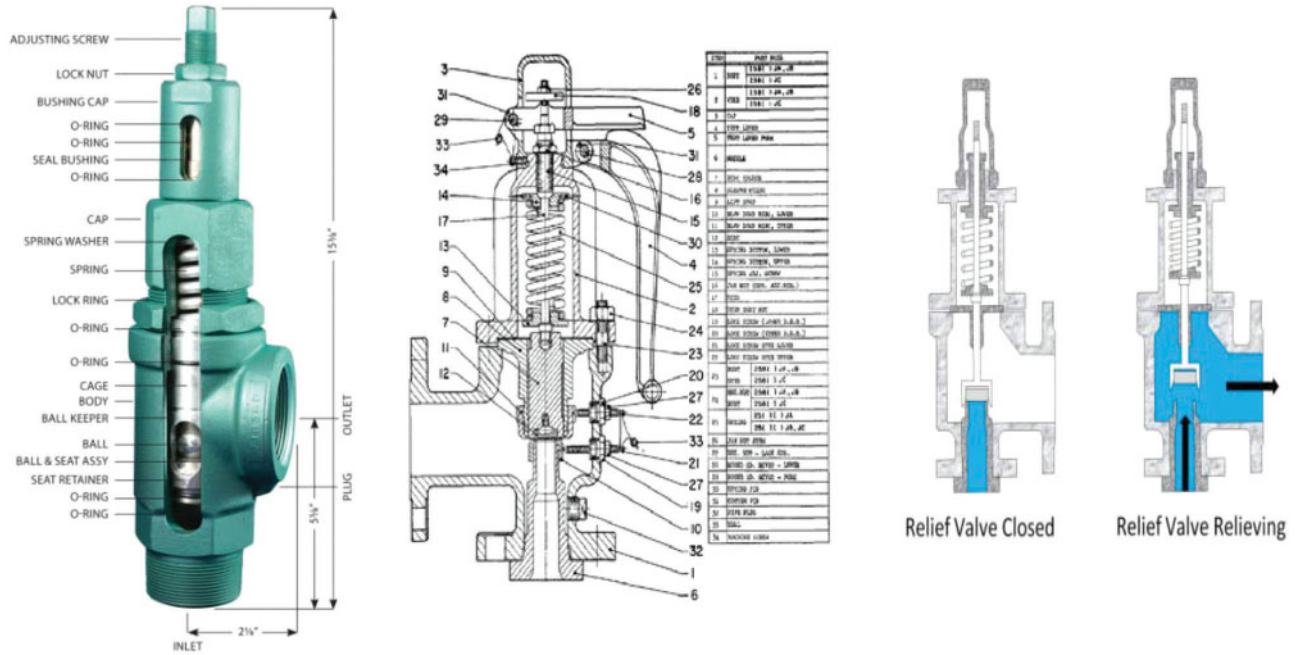


Figure 43 Relief valves.

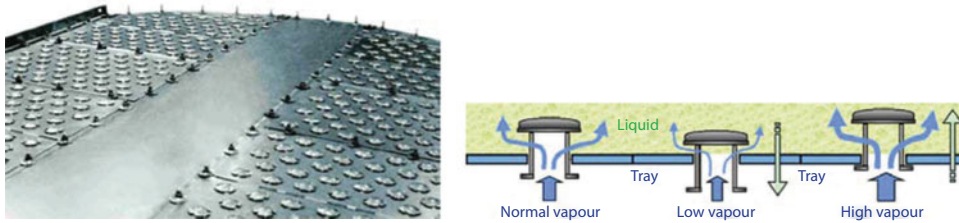


Figure 44 A valve tray.

- Natural gas
- Nitrogen
- Plant air
- Instrument air
- Steam of various pressures
- Cooling water
- Service water
- Boiler feed water
- Fire water
- Fuel gas
- City water

Your company safety policy does not permit you to cross-connect these systems. Connecting natural gas to plant air killed 17 workers at a Louisiana refinery.

Vacuum Distillation: 1. Distillation under reduced pressure (less than atmospheric), which lowers the

boiling temperature of the liquid being distilled. This technique prevents cracking or decomposition of the charge stock which occurs above 1000°F (538°C). 2. A distillation column that operates at sub-atmospheric pressure. Vacuum distillation permits the further distillation of heavy feed stocks at reduced temperatures that minimize cracking reactions.

Vacuum Gas Oil (VGO): A side stream from the vacuum distillation tower.

Vacuum Residuum: The heaviest product from a vacuum distillation column.

Valves: A valve is a device that regulates, directs or controls the flow of a fluid (gases, liquids, fluidized solids, or slurries) by opening, closing or partially obstructing various passageways.

Diaphragm valve: A type of device in which a flexible membrane is used to restrict the rate of flow. The membrane is usually made from a flexible natural or synthetic rubber. Diaphragm valves are typically used for fluids that contain suspended solids (See Figure 38).

Gate valve. This valve closes by sliding a plate or gate down between two grooves. Used to isolate different portions of the process equipment not used to control flow. The valve closes clockwise and takes about a dozen turns to close. Ninety percent of the valves used in process plants are gate valves (See Figure 39).

Globe valve: A device that regulates the flow of a fluid in a pipe and consists of a flat disc that sits on a fixed ring seat. The disc is movable and allows flow through the valve (See Figure 40).

Plug valve: This valve goes from 100% open to shut by turning a valve 90°. The natural gas supply to your house is shut off with a plug valve (See Figure 41).

Control valve: This valve is used to alter flows remotely. Normally it is moved by air pressure. A gate valve is sometimes used to control flows locally, but this wears out the valve and is best avoided (See Figure 42).

Relief valves: These valves open to relieve excess pressure to protect a vessel from failure. Also called safeties or pop valves (See Figure 43).

Valve Trays: 1. Fractionator trays that have perforations covered by discs that operate as valves and allow the upward passage of vapor. 2. In valve trays, perforations are covered by lift-able caps. Vapor flows lift the caps, thus self-creating a flow area for the passage of vapor. The lifting caps direct the vapor to flow horizontally into the liquid, thus providing better mixing than is possible in sieve trays (See Figure 44).

Vapor: The gaseous phase of a substance that is a liquid at normal temperature and pressure.

Vapor/Liquid Ratio (V/L): The vapor/liquid ratio (V/L) is the ratio of the volume of vapor formed at atmospheric pressure to the volume of gasoline in a standard test apparatus. The vapor-lock tendency of the gasoline sample can be measured more reliably in terms of its V/L ratio than in terms of its vapor pressure. The V/L ratio also increases with rise in temperature.

Vapor Pressure: 1. As a liquid is heated, the molecules in the liquid try to escape into the vapor phase. The hotter the liquid, the harder they try to escape. The pressure that the molecules of liquid create as they push out into the vapor space is the liquid vapor pressure.

More volatile liquids such as LPG have a higher vapor pressure than less volatile diesel oil. 2. The pressure exerted by a volatile liquid as determined by ASTM D-323, Standard Method of Test for Vapor Pressure of Petroleum Products (Reid Method). 3. Is a measure of the surface pressure necessary to keep a liquid from vaporizing. The vaporizing tendency of gasoline is measured in terms of its vapor pressure. It is related to vapor lock and engine starting. Vapor lock arises due to the vaporization of the fuel in fuel lines, fuel pump, carburetor, etc, making bubbles of vapor, which prevent the normal flow of fuel. This occurs if the gasoline contains too high a percentage of low-boiling components as observed by a very high vapor pressure. Alternatively, if the gasoline contains only too few low boiling components as indicated by a low vapor pressure, then the fuel will not vaporize readily making it difficult in starting. (See Reid Vapor Pressure, RVP)

Vapor Lock: Is the phenomenon of insufficient gasoline flow from a fuel pump due to its inability to pump the mixture that results from low pressure or high temperature, which has high volatility.

Vapor Lock Index: A measure of the tendency of a gasoline to generate excessive vapors in the fuel line, thus causing displacement of a liquid fuel and subsequent interruption of normal engine operation. The vapor-lock index generally is related to RVP and percentage distilled at 158°F (70°C).

Virgin Material, Gas Oil, etc: Virgin material is material distilled from crude oil but not subjected to processes that chemically alter its composition.

Virgin Stocks: Petroleum oils that have not been cracked or otherwise subjected to any treatment that would produce appreciable chemical change in their components.

Visbreaking: 1. A thermal cracking process in which heavy atmospheric or vacuum-still bottoms are cracked at moderate temperatures to increase production of distillate products and reduce viscosity of the distillation residues. 2. A process in which heavy oil is thermally cracked just enough to lower or break the viscosity. A small quantity of gas oil and lighter products are formed in the process.

Viscosity ASTM D445: Internal resistance to the flow of liquids is expressed as viscosity. The property of liquids under flow conditions that causes them to resist instantaneous change of shape or instantaneous rearrangement of their parts due to internal friction.

Viscosity is generally measured in seconds, at a definite temperature, required for a standard quantity of oil to flow through a standard apparatus. Common viscosity scales in use are Saybolt Universal, Saybolt Furol, poises, kinematic [stokes, or centistokes (cSt)]. Usually, the viscosity measurements are carried out at 100°F (38°C) and 210°F (99°C).

Viscosity is a very important property for the heavy products obtained from the crude oil. The viscosity acts as an important characterization property in the blending units associated to heavy products such as bunker fuel. Typically, the viscosity of these products is specified to be within a specified range and this is achieved by adjusting the viscosities of the streams entering the blending unit.

Viscosity Index (VI): This index is a series of numbers ranging from 0 to 100 which indicate the rate of change of viscosity with temperature. A Viscosity Index of 100 indicates an oil that does not tend to become viscous at low temperatures or become thin at elevated temperatures.

Typically paraffin-base lubricating oils exhibit a Viscosity Index of nearly 100, whereas naphthenes-base oils on the market show about 40 Viscosity Index, and some naphthenic oils have a Viscosity Index of zero or lower. Paraffin wax has a V.I. of about 200, and hence its removal reduces the V.I. of raw lube stocks. By solvent extraction processes, lubricating oils of Viscosity Index higher than 100 can be produced.

Volatile: A hydrocarbon is volatile if it has a sufficient amount of butanes and higher material to noticeably give off vapors at atmospheric conditions.

Volatile Organic Compounds (VOCs): Organic chemicals that have a high vapor pressure at ordinary room temperature. Their high vapor pressure results from a low boiling point, which causes large numbers of molecules to evaporate or sublime from the liquid or solid form of the compound and enter the surrounding air. E.g., formaldehyde (HCHO), which evaporates from paint, has a boiling point of only -19°C (-2°F).

One VOC that is a known human carcinogen is benzene, which is a chemical found in environmental tobacco smoke, stored fuels, and exhaust from cars. Benzene also has natural sources such as volcanoes and forest fires. It is frequently used to make other chemicals in the production of plastics, resins, and synthetic fibers. Benzene evaporates into the air quickly and the vapor of benzene is heavier than air allowing the compound to sink into low-lying areas. Benzene has also been known

to contaminate food and water and if digested can lead to vomiting, dizziness, sleepiness, rapid heartbeat, and at high levels, even death may occur.

VOCs are many and varied, are dangerous to human health or cause harm to the environment. Harmful VOCs typically are not acutely toxic, but have compounding long-term health effects. Because the concentrations are usually low and the symptoms slow to develop, research into VOCs and their effects is difficult.

Volatility: As measured by the distillation characteristics, helps to determine the relative proportion of the various hydrocarbons throughout the boiling range of a gasoline. It is the distillation characteristics along with vapor pressure and vapor/liquid ratio that help to control the performance of the fuel with respect to starting, warm-up, acceleration, vapor-lock, evaporation losses, crankcase dilution, fuel economy and carburetor icing.

Volatility Factor: An empirical quantity that indicates good gasoline performance with respect to volatility. It involves actual automobile operating conditions and climatic factors. The volatility factor is generally defined as a function of RVP (Reid vapor pressure), percentage distilled at 158°F (70°C) and percentage distilled at 212°F (100°C). This factor is an attempt to predict the vapor-lock tendency of a gasoline.

vppm: Parts per million by volume.

VRC: Vacuum reduced crude; vacuum tower bottoms.

WABP: Weight average boiling point:

$$\text{WABP} = \sum_{i=1}^n X_{wi} T_{bi}$$

where

X_{wi} = weight fraction of component i.

T_{bi} = average boiling point of component i.

Wash Zone: A section in a column where the column vapor is washed of entrained heavy materials by contact with a cooler injected liquid. A section of packed material is often used to promote good mixing of the liquid and vapor in the wash zone. All vacuum distillation columns have wash zones to remove heavy residual material that is carried up the column from the flash zone. If washing is inadequate, the heavy residual material forms petroleum coke and plugs the column above the flash zone.

Water hammer: A violent and potentially damaging shock wave in a pipeline caused by the sudden change in flow rate, such as by the rapid closure of a valve. The effect is avoided by controlling the speed of valve closure, lowering the pressure of the fluid, or lowering the fluid flow rate.

Water vapor: The gaseous state of water dispersed with air at a temperature below the boiling point of the water. The amount present in air is designated by the humidity. The “relative humidity” is the amount of water vapor in a mixture of dry air. A relative humidity of 100% corresponds to the partial pressure of water vapor being equal to the equilibrium vapor pressure and depends on the temperature and pressure.

Watson Characterization factor (K_w): *see Characterization factor*

Wax: A solid or semi-solid material consisting of a mixture of hydrocarbons obtained or derived from petroleum fractions, or through a Fischer-Tropsch type process, in which the straight-chained paraffins series predominate. This includes all marketable wax, whether crude or refined, with a congealing point (ASTM D 938) between 100–200°F (37.8–93°C) and a maximum oil content (ASTM D 3235) of 50 weight percent.

Weeping: A phenomenon that occurs in a distillation column in which liquid on a sieve plate passes down through the perforations intended for the vapor to pass up. Weeping occurs when the velocity of the upward vapor is too low. This may be caused by insufficient boil-up.

Weir: A vertical obstruction across a channel carrying a liquid over which the liquid discharges. In a distillation column, a weir is used to retain an amount of liquid on a sieve tray or plate. While the vapor enriched with the more volatile component rises up through the perforations on the sieve tray or plate, the liquid cascades over the weir into the downcomer to the tray below. The weir crest is the top of the weir over which the liquid flows.

Weighted average inlet

temperature (WAIT): [Weight of catalyst in reactor 1 × inlet temperature in reactor 1 + weight of catalyst in reactor 2 × inlet temperature in reactor 2 + weight of catalyst in reactor 3 × inlet temperature in reactor 3]/total weight of catalyst, i.e. $[WCR_1 \times R_{1IT} + WCR_2 \times R_{2IT} + WCR_3 \times R_{3IT}]/(WCR_1 +$

$WCR_2 + WCR_3)$, where WCR_1 , WCR_2 , WCR_3 are the weights of catalysts in reactors 1, 2, 3 and R_{1IT} , R_{2IT} , R_{3IT} are the inlet temperatures for reactors, 1, 2 and 3 respectively.

Weighted average bed temperature (WABT): $[WCR_1 (R_{1IT} + R_{1OT})/2 + WCR_2 (R_{2IT} + R_{2OT})/2 + WCR_3 (R_{3IT} + R_{3OT})/2]/\text{total Weight of catalyst}$, where WCR_1 , WCR_2 , WCR_3 are the weights of catalysts in reactors 1, 2, 3; R_{1IT} , R_{2IT} , R_{3IT} are the inlet temperatures for reactors 1, 2, 3 and R_{1OT} , R_{2OT} , R_{3OT} are the outlet temperatures for reactors 1, 2, and 3 respectively.

Well: 1. A natural oil or gas reservoir that exists below a layer of sedimentary rock. 2. A hole bored or drilled into the earth for the purpose of obtaining water, oil, gas or other natural resources.

West Texas Intermediate (WTI): A type of crude oil commonly used as a price benchmark.

Wet Gas: 1. Natural gas that has not had the butane, C_4 and natural gasoline removed. Also the equivalent refinery gas stream. 2. A term used to describe light hydrocarbon gas dissolved in heavier hydrocarbons. Wet gas is an important source of LPG. 3. Water that is present in natural gas in offshore platforms. It is necessary to remove the water from the gas for export through subsea pipelines. The pipeline is dosed with corrosion inhibitors to prevent hydrate formation.

White Oil: Sometimes kerosene, sometimes treated kerosene used for pharmaceutical purposes, and in the food industry.

WHSV: Weight hour space velocity; weight of feed per hour per weight of catalyst.

Wick Char: A test used as an indication of the burning quality of a kerosene or illuminating oil. It is defined as the weight of deposits remaining on the wick after a specified amount of sample is burned.

What-If Analysis (WIA): A safety review method, by which “What If” investigative questions (i.e., brainstorming and/or checklist approach) are asked by an experienced and knowledgeable team of the system or component under review where there are concerns about possible undesired events. Recommendations

for the mitigation of identified hazards are provided.
(See Process Safety Management/Hazid/Hazop)

wppm: Parts per million by weight.

Xylene, $C_6H_4(CH_3)_2$: 1. Colorless liquid of the aromatic group of hydrocarbons made from the catalytic reforming of certain naphthenic petroleum fractions. Used as high-octane motor and aviation gasoline blending agents, solvents chemical intermediates. 2. One of the aromatic compounds. Xylene has a benzene ring and two methyl radicals attached and three isomers namely: ortho, para and metaxylene. Used as a gasoline blending compound or chemical feedstock for making phthalic acids and resins.

Yield: Either the percent of a desired product or all the products resulting from a process involving chemical changes to the feed.

Zeolites: 1. Compounds used extensively as catalysts, made of silica or aluminum as well as sodium or calcium and other compounds. Zeolites come in a variety of forms – porous and sand like or celatinous and provide the platform for numerous catalysts. The solid zeolites have extensive pores that give very large surface areas. The precise control during fabrication of the pores sizes enables selected access to different size molecules during reactions. 2. A class of minerals that are hydrated aluminosilicates. An aluminosilicate is where some of the Si atoms in silica (SiO_4) are replaced with aluminum giving an excess negative charge. Hydrated means that water is strongly associated with these materials by hydrogen bonding. A positively charged counter ion is required to balance the negative charge on the zeolite. Zeolites are extremely porous materials, with a regular internal structure of cavities of defined size and shape.

Appendix A

Equilibrium K values

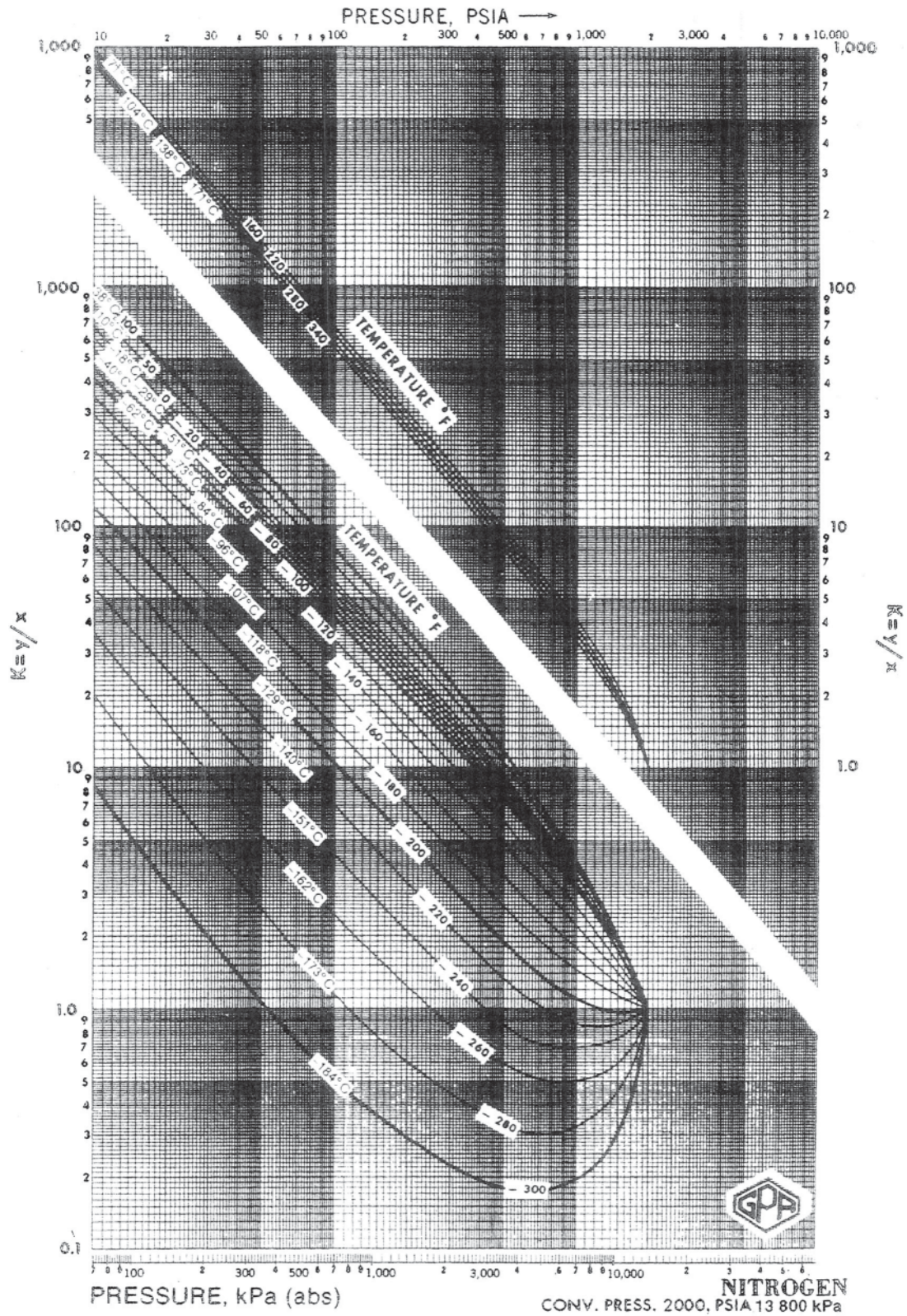


Figure A.1 Pressure vs. K for nitrogen at convergence pressure of 2000 psia (13,800 kPa). Used by permission, Gas Processors Suppliers Association Data Book, 12th Ed., V. 1 and 2, (2004), Tulsa, Okla.

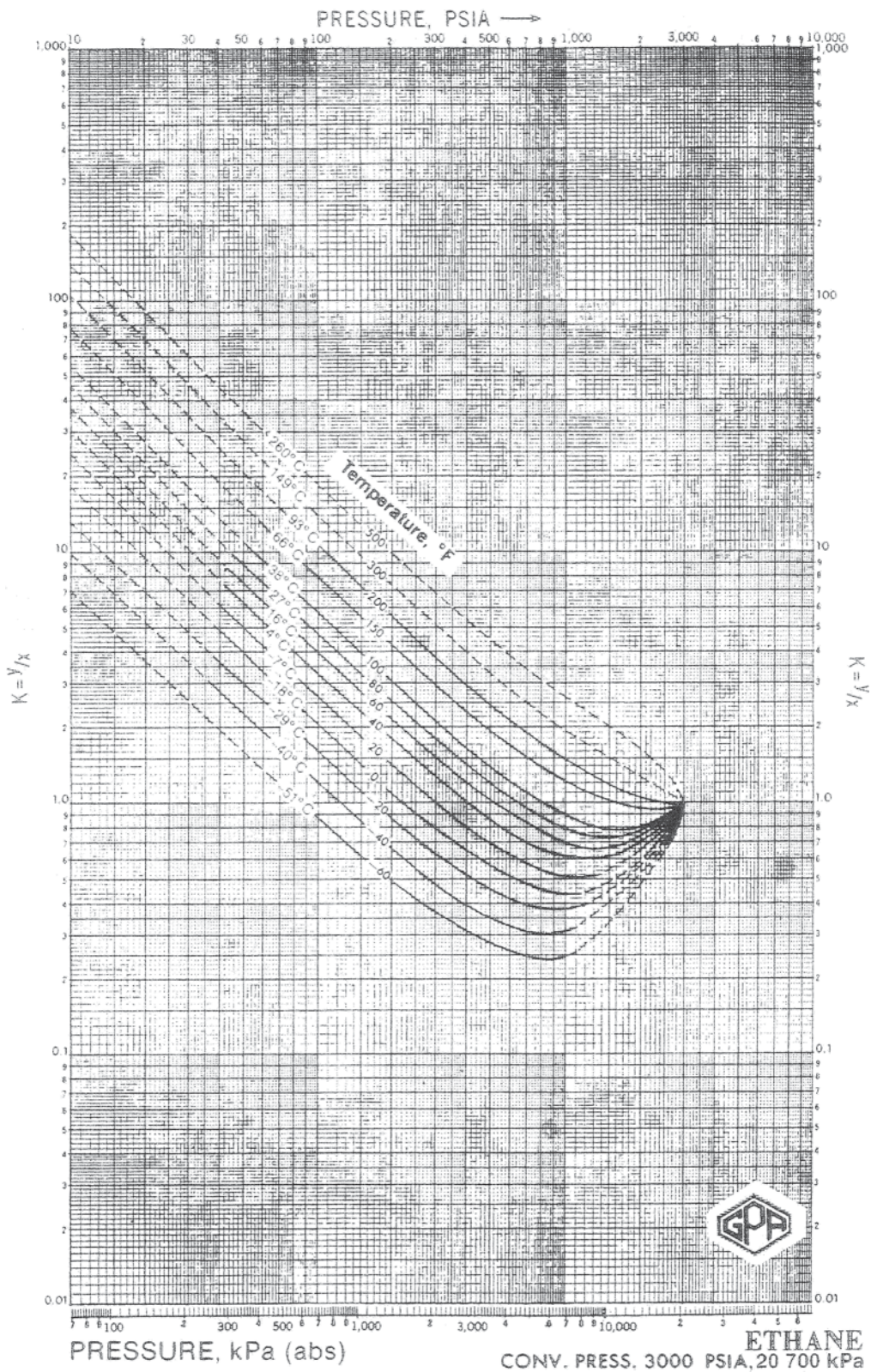


Figure A.2 Pressure vs. K for ethane (C₂H₆) at convergence pressure of 3000 psia (20,700 kPa). Used by permission, Gas Processors Suppliers Association Data Book, 12th Ed., V. 1 and 2, (2004), Tulsa, Okla.

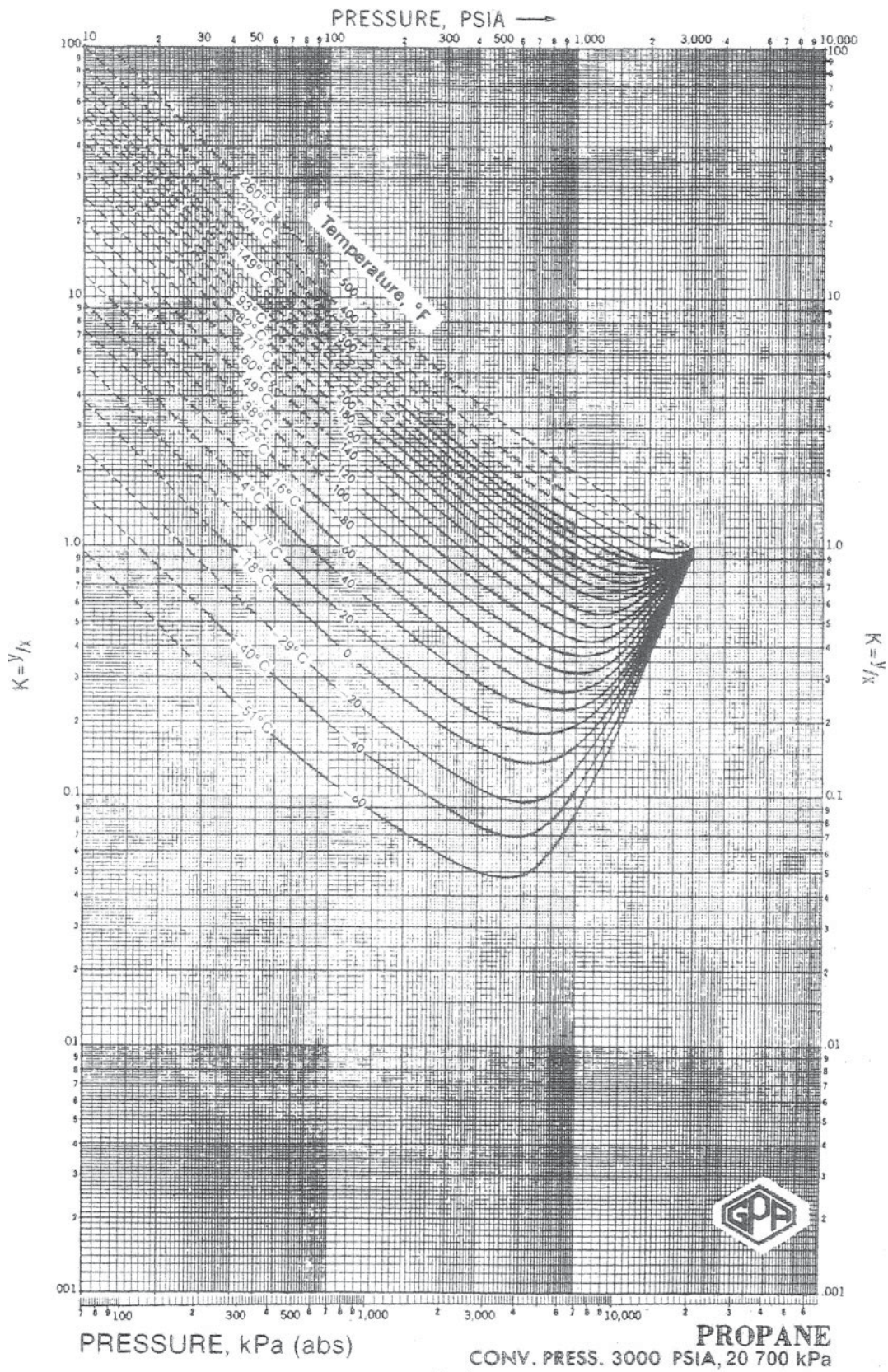


Figure A.3 Pressure vs. K for propane (C₃H₈) at convergence pressure of 3000 psia (20,700 kPa). Used by permission, Gas Processors Suppliers Association Data Book, 12th Ed., V. 1 and 2, (2004), Tulsa, Okla.

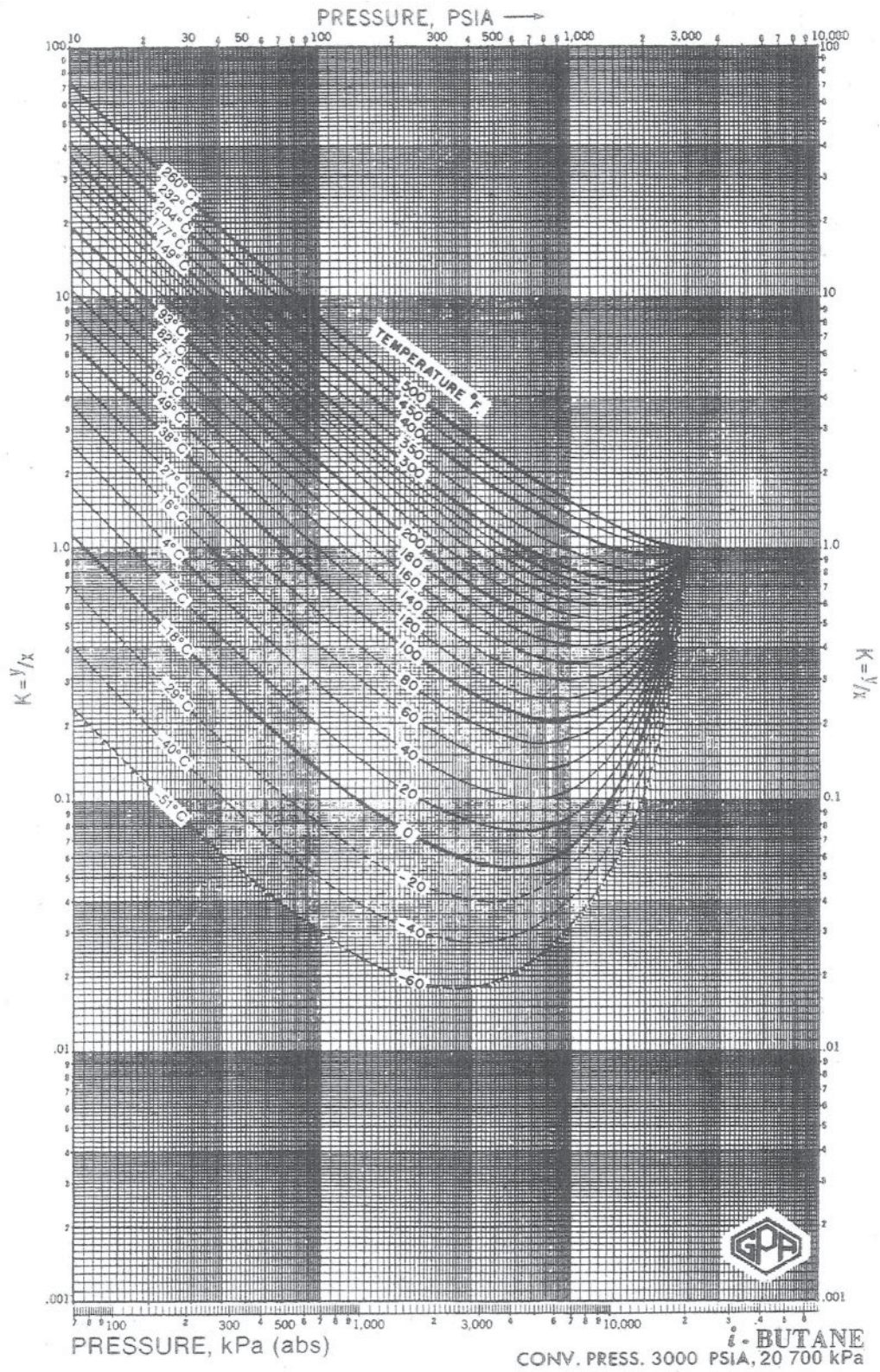


Figure A.4 Pressure vs. K for *i*-Butane ($i\text{-C}_4\text{H}_{10}$) at convergence pressure of 3000 psia (20,700 kPa). Used by permission, Gas Processors Suppliers Association Data Book, 12th Ed., V. 1 and 2, (2004), Tulsa, Okla.

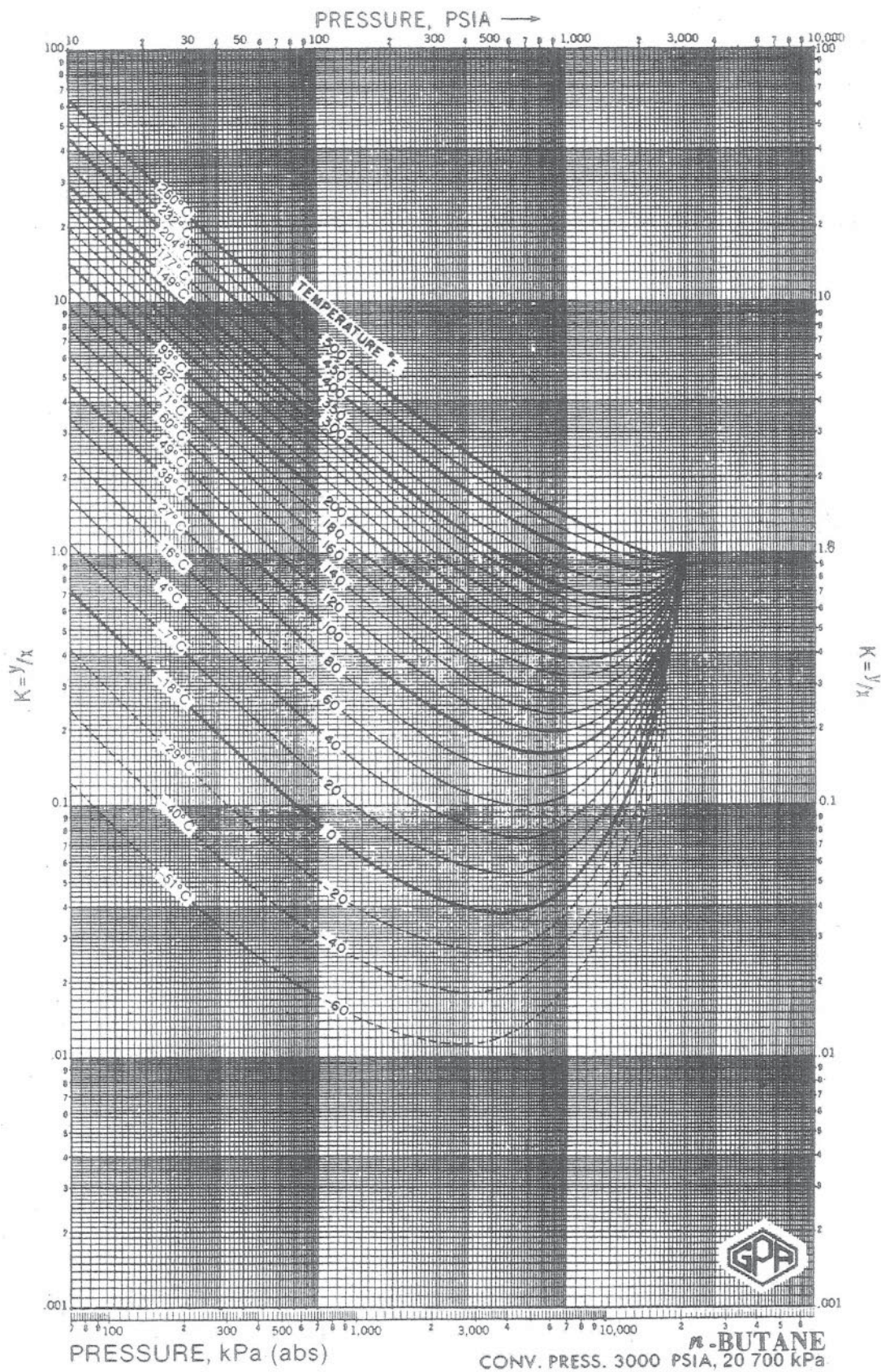


Figure A.5 Pressure vs. K for n-Butane (nC_4H_{10}) at convergence pressure of 3000 psia (20,700 kPa). Used by permission, Gas Processors Suppliers Association Data Book, 12th Ed., V. 1 and 2, (2004), Tulsa, Okla.

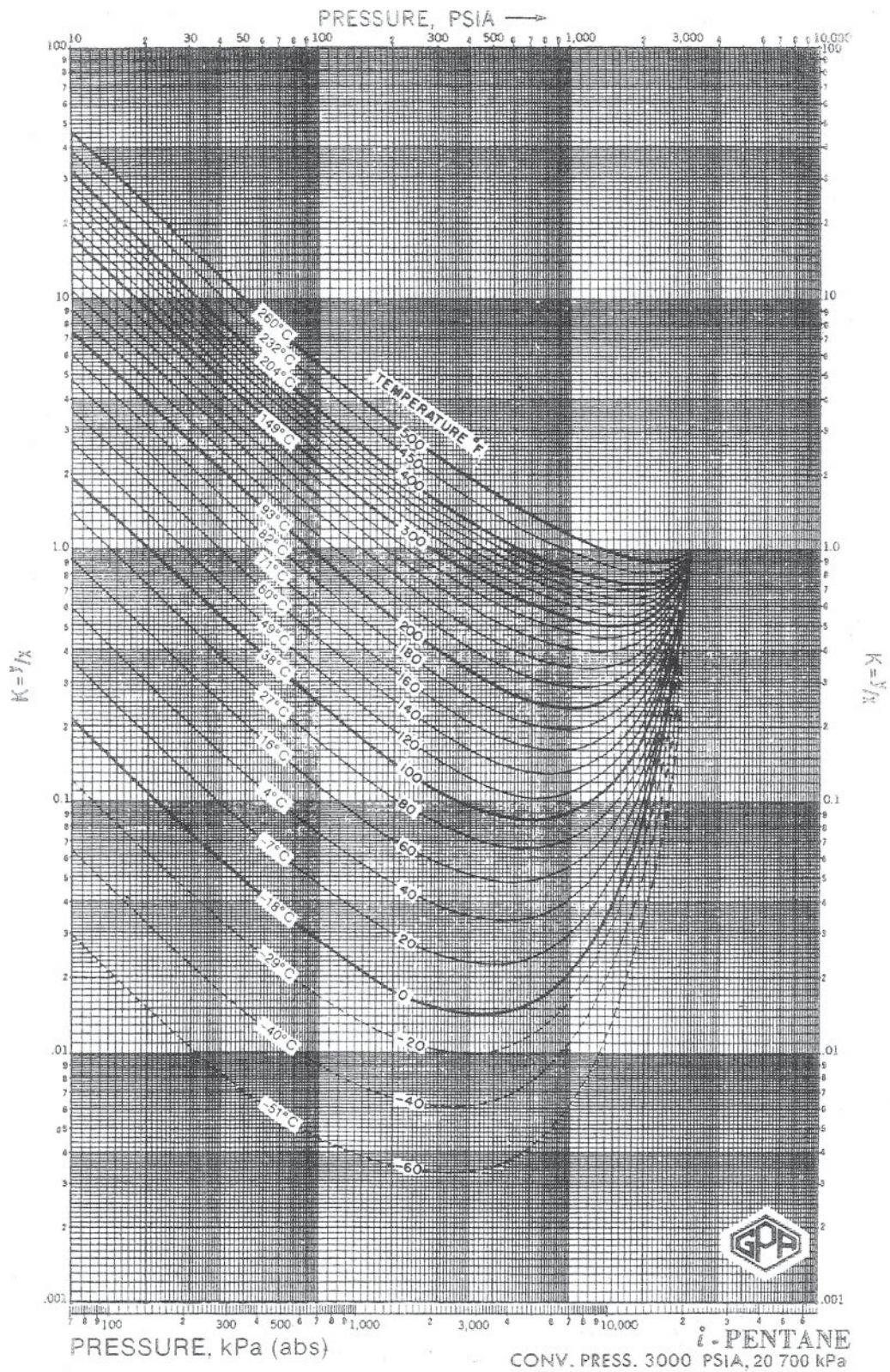


Figure A.6 Pressure vs. K for i -C₅H₁₂ at convergence pressure of 3000 psia (20,700 kPa). Used by permission, Gas Processors Suppliers Association Data Book, 12th Ed., V. 1 and 2, (2004), Tulsa, Okla.

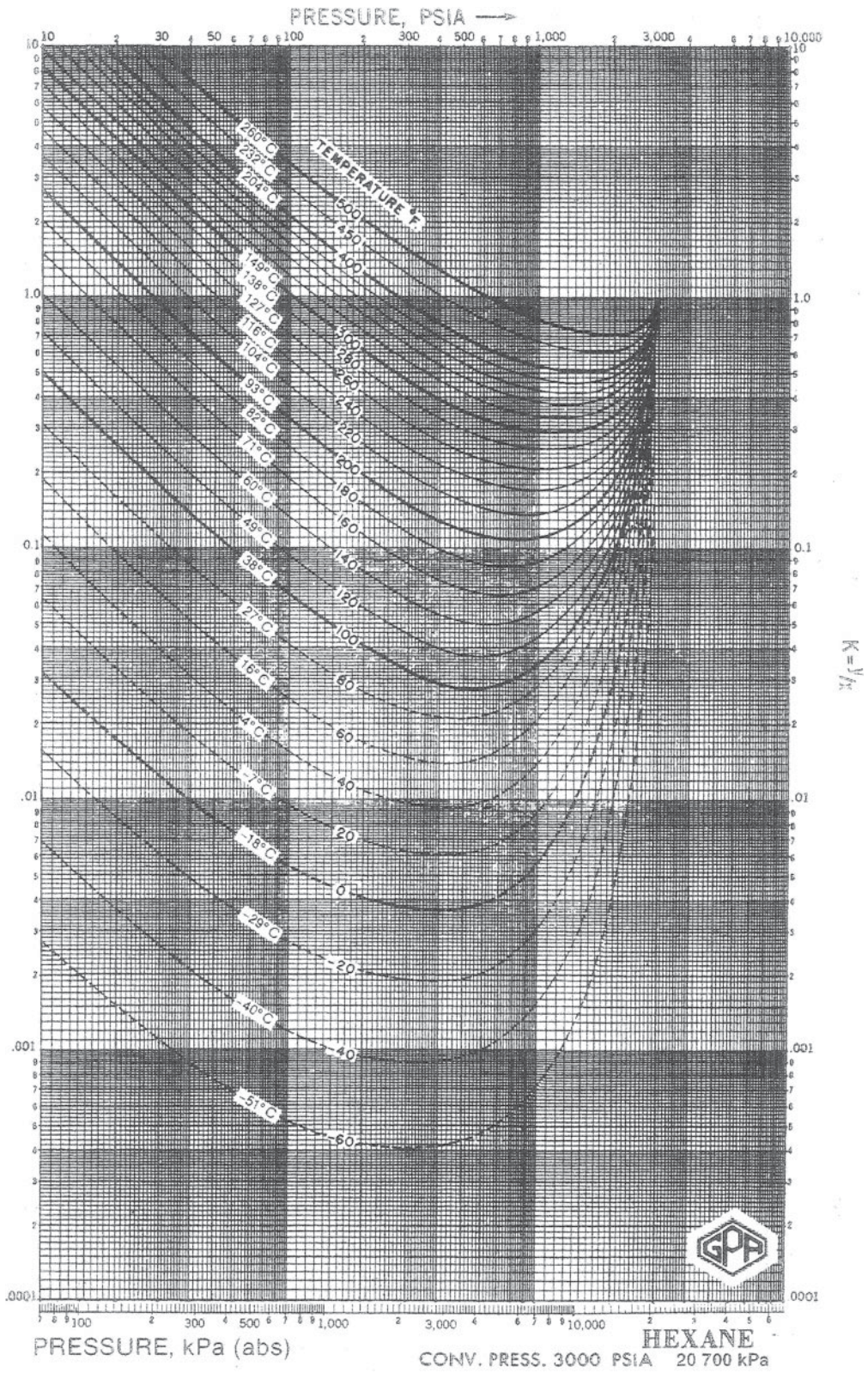


Figure A.7 Pressure vs. K for Hexane (C_6H_{14}) at convergence pressure of 3000 psia (20,700 kPa). Used by permission, Gas Processors Suppliers Association Data Book, 12th Ed., V. 1 and 2, (2004), Tulsa, Okla.

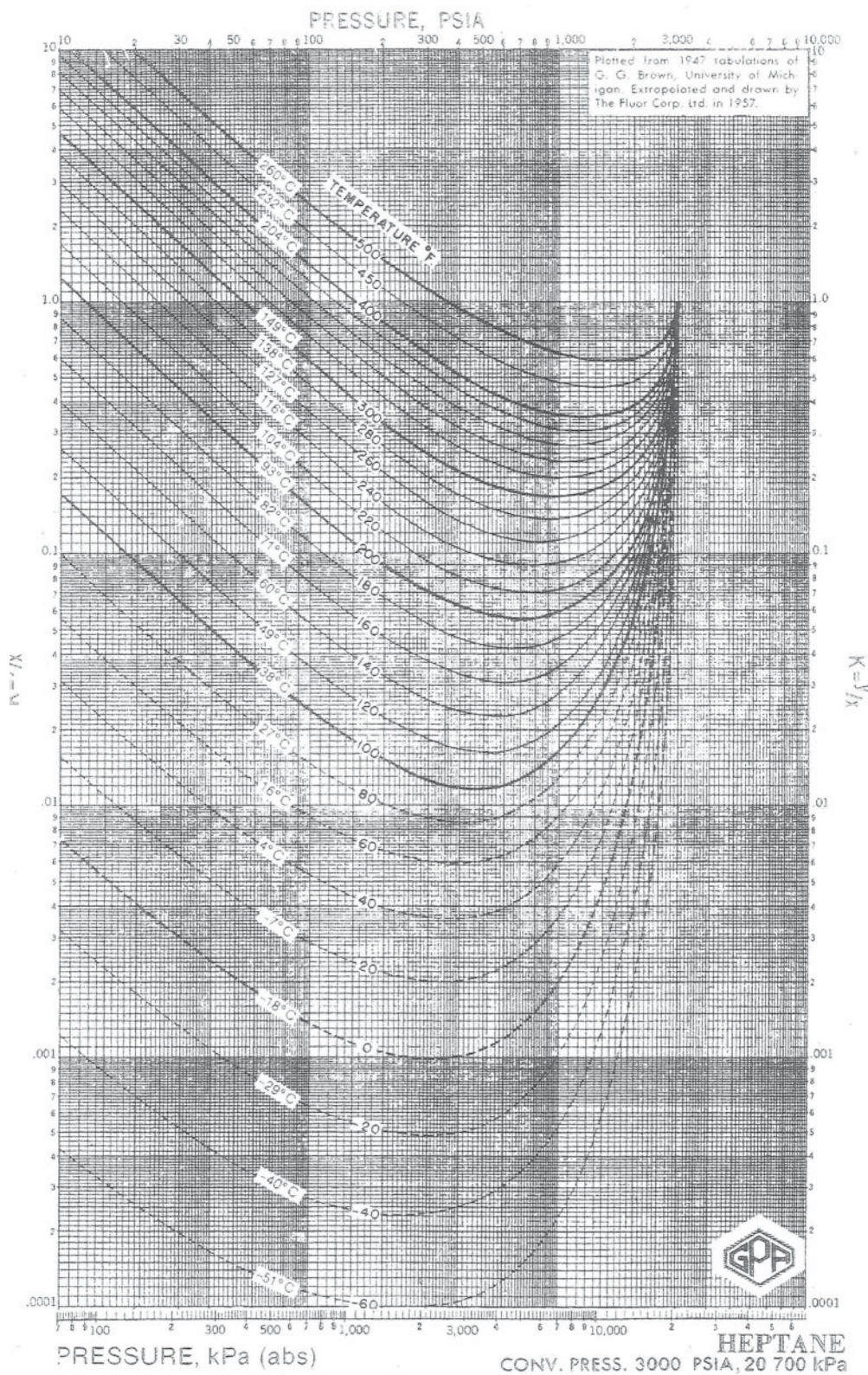


Figure A.8 Pressure vs. K for Heptane (C₇H₁₆) at convergence pressure of 3000 psia (20,700 kPa). Used by permission, Gas Processors Suppliers Association Data Book, 12th Ed., V. 1 and 2, (2004), Tulsa, Okla.

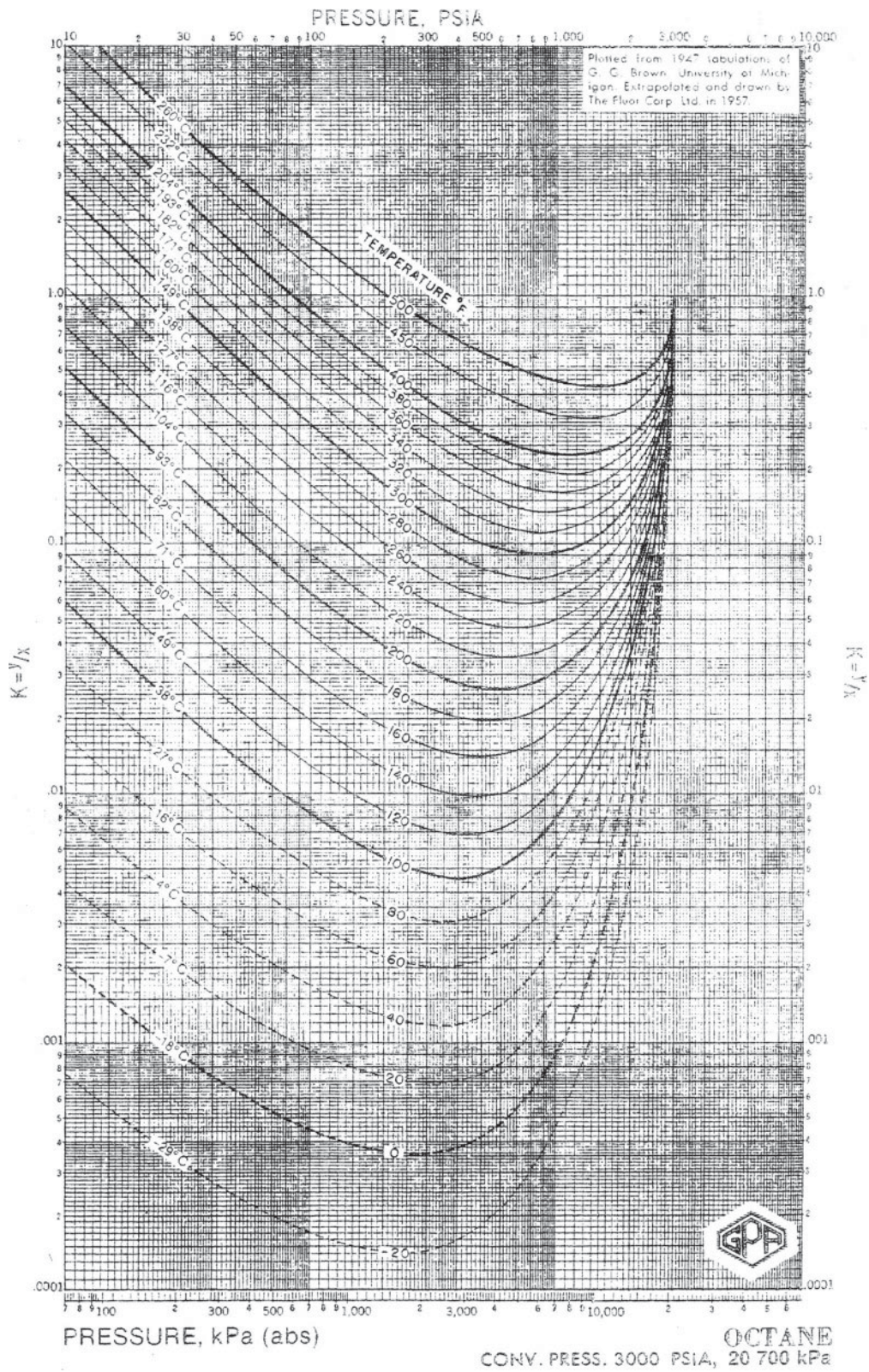


Figure A.9 Pressure vs. K for Octane (C_8H_{18}) at convergence pressure of 3000 psia (20,700 kPa). Used by permission, Gas Processors Suppliers Association Data Book, 12th Ed., V. 1 and 2, (2004), Tulsa, Okla.

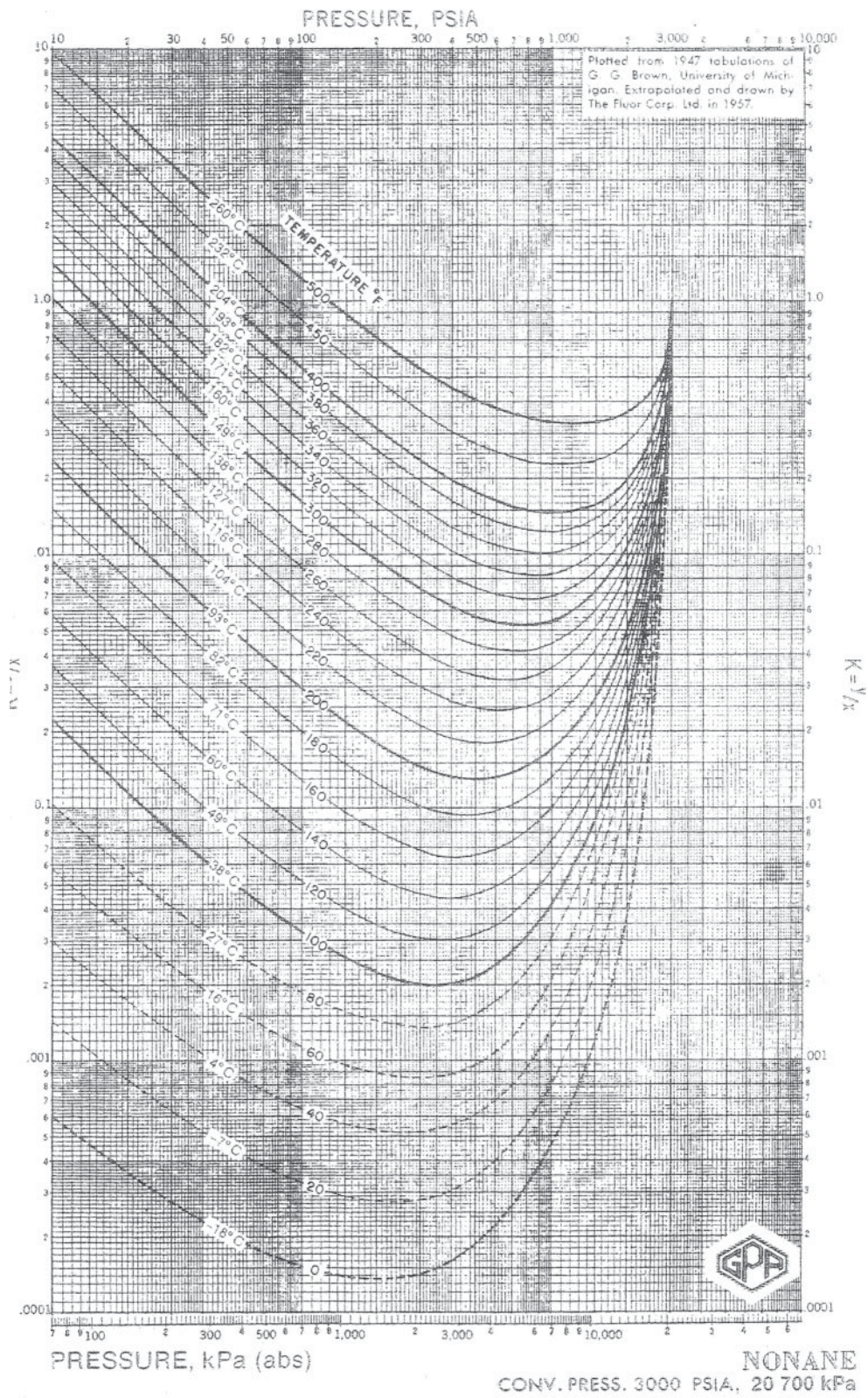


Figure A.10 Pressure vs. K for Nonane at convergence pressure of 3000 psia (20,700 kPa). Used by permission, Gas Processors Suppliers Association Data Book, 12th Ed., V. 1 and 2, (2004), Tulsa, Okla.

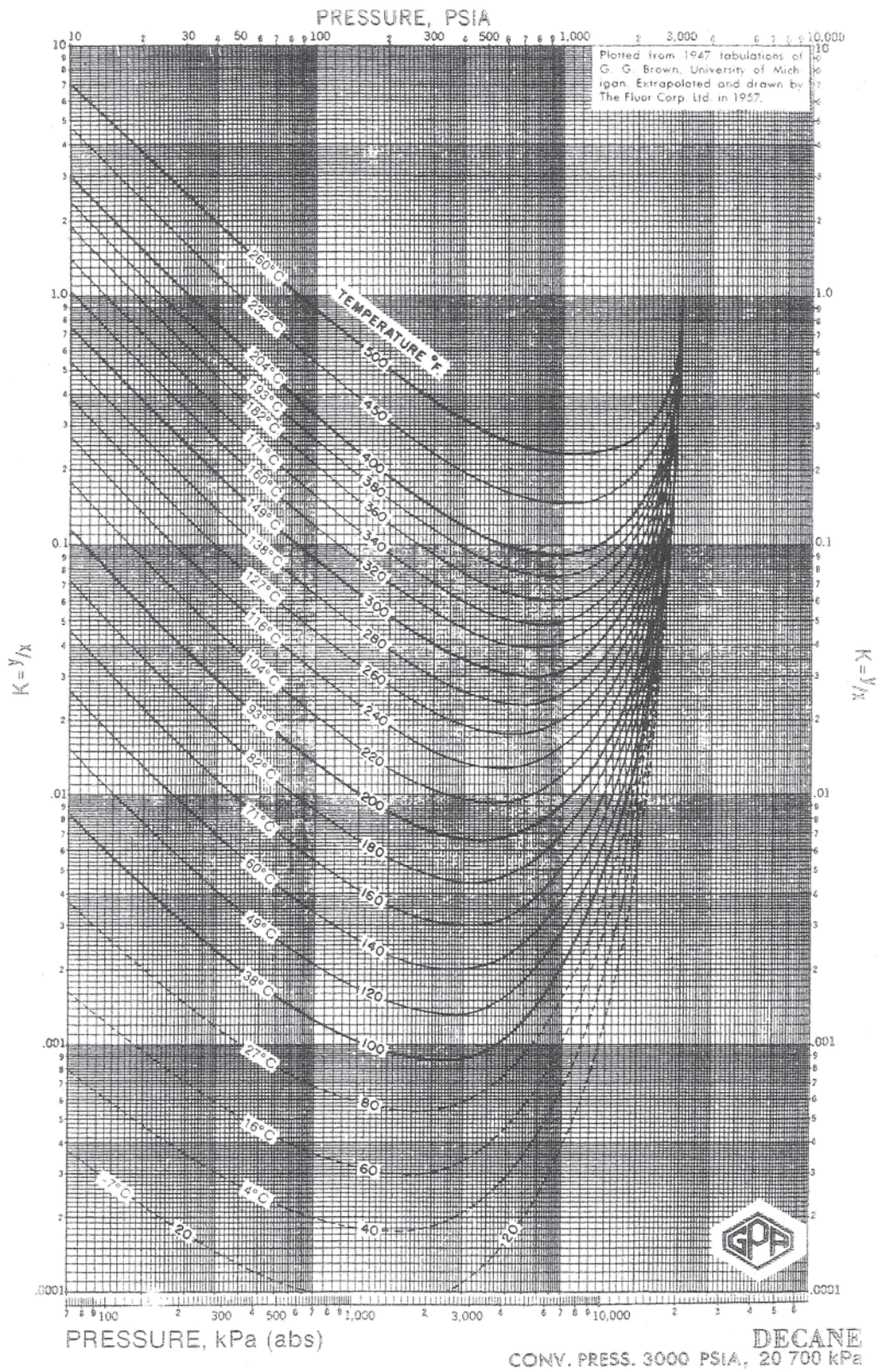


Figure A.11 Pressure vs. K for Decane at convergence pressure of 3000 psia (20,700 kPa). Used by permission, Gas Processors Suppliers Association Data Book, 12th Ed., V. 1 and 2, (2004), Tulsa, Okla.

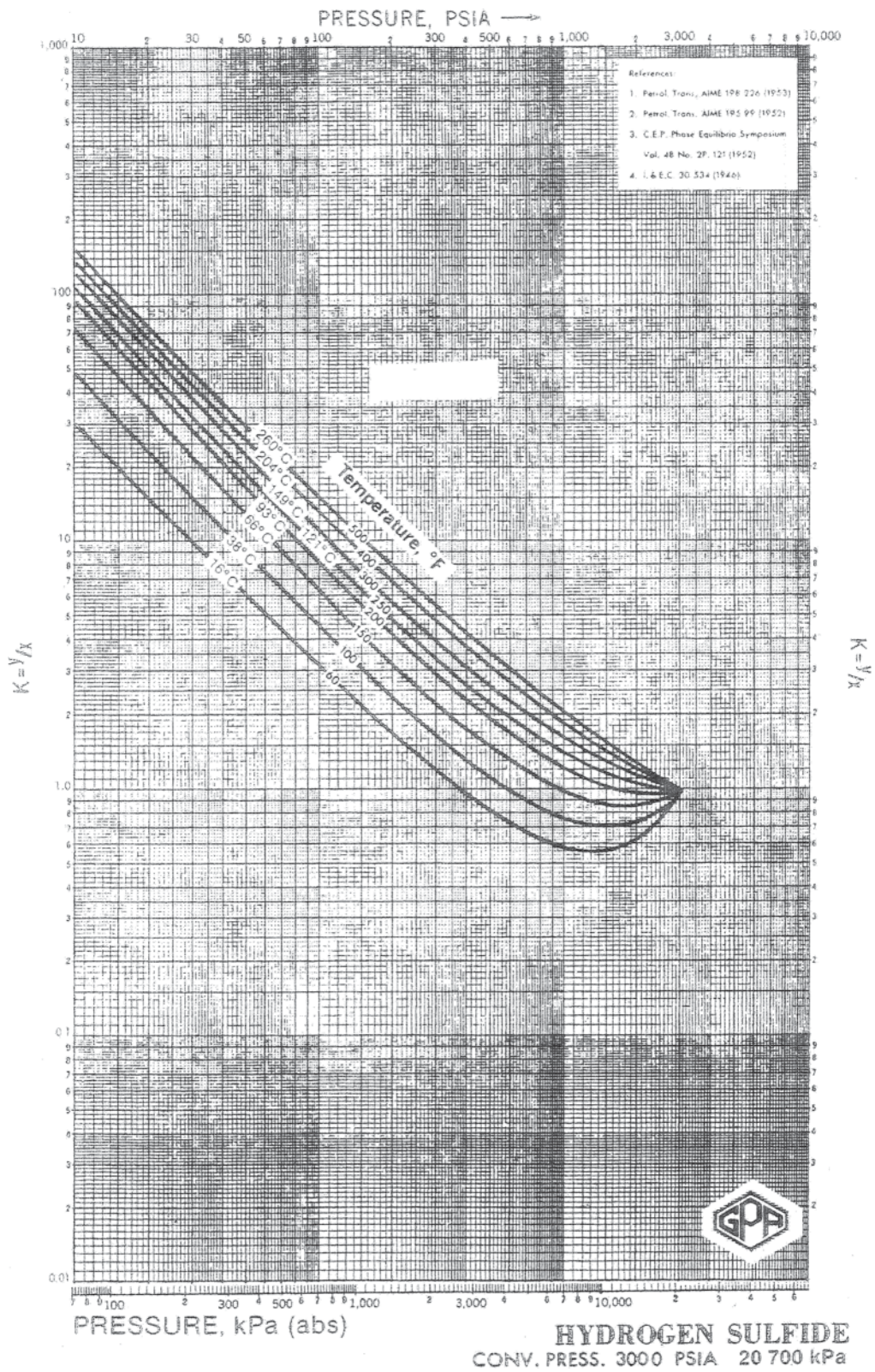


Figure A.12 Pressure vs. K for Hydrogen sulphide (H₂S) at convergence pressure of 3000 psia (20,700 kPa). Used by permission, Gas Processors Suppliers Association Data Book, 12th Ed., V. 1 and 2, (2004), Tulsa, Okla.

Appendix B

Analytical Techniques

B.1 Useful Integrals

$$\int_0^x \frac{dx}{1-x} = \ln \frac{1}{1-x}$$

$$(B-1) \int_0^x \frac{1+\varepsilon x}{(1-x)^2} dx = \frac{(1-x)x}{1-x} - \varepsilon \ln \frac{1}{1-x} \quad (B-5)$$

$$\int_0^x \frac{dx}{(1-x)^2} = \frac{x}{1-x}$$

$$(B-2) \int_0^x \frac{(1+\varepsilon x)^2}{(1-x)^2} dx = 2\varepsilon(1+\varepsilon) \ln(1-x) + \varepsilon^2 x + \frac{(1+\varepsilon)^2 x}{1-x} \quad (B-6)$$

$$\int_0^x \frac{dx}{1+\varepsilon x} = \frac{1}{\varepsilon} \ln(1+\varepsilon x)$$

$$(B-3) \int_0^x \frac{dx}{(1-x)(\Theta_B-x)} = \frac{1}{(\Theta_B-1)} \ln \frac{\Theta_B-x}{\Theta_B(1-x)}, \Theta_B \neq 1 \quad (B-7)$$

$$\int_0^x \frac{1+\varepsilon x}{1-x} dx = (1+\varepsilon) \ln \frac{1}{1-x} - \varepsilon x$$

$$(B-4) \int_0^x \frac{dx}{ax^2+bx+c} = \frac{-2}{2ax+b} + \frac{2}{b}, \text{ for } b^2=4ac \quad (B-8)$$

$$\int_0^x \frac{dx}{ax^2 + bx + c} = \frac{1}{a(p-q)} \ln \left[\frac{q_C x - p}{p x - q} \right], \text{ for } b^2 > 4ac \quad \int \cos(ax+b) dx = \frac{1}{a} \sin(ax+b) + C \quad (\text{B-19})$$

$$\int x^n dx = \frac{1}{n+1} x^{n+1} + C \quad (\text{B-10}) \quad \int \cos ax dx = \frac{1}{a} \sin ax + C \quad (\text{B-20})$$

$$\int \frac{1}{x} dx = \ln x + C \quad (\text{B-11}) \quad \int \cos(ax+b) dx = \frac{1}{a} \sin(ax+b) + C \quad (\text{B-21})$$

$$\int \frac{dx}{ax+b} = \frac{1}{a} \ln(ax+b) + C \quad (\text{B-12}) \quad \int \tan ax dx = \frac{1}{a} \ln(\sec ax) + C \quad (\text{B-22})$$

$$\int a^n dx = \frac{1}{\ln a} a^x + C \quad (\text{B-13}) \quad \int \frac{dx}{\sqrt{a^2 - x^2}} = \sin^{-1} \left(\frac{x}{a} \right) + C \quad (\text{B-23})$$

$$\int e^x dx = e^x + C \quad (\text{B-14}) \quad \int \frac{dx}{a^2 + x^2} = \frac{1}{a} \tan^{-1} \left(\frac{x}{a} \right) + C \quad (\text{B-24})$$

$$\int \sin x dx = -\cos x + C \quad (\text{B-15}) \quad \int u dv = uv - \int v du \quad (\text{B-25})$$

$$\int \cos dx = \sin x + C \quad (\text{B-16}) \quad \int \ln x dx = x \ln(x) - x + C \quad (\text{B-26})$$

$$\int \tan x dx = -\ln(\cos x) + C = \ln(\sec x) + C \quad (\text{B-17}) \quad \int \frac{x dx}{a^2 + x^2} = \frac{1}{2} \ln(a^2 + x^2) + C \quad (\text{B-27})$$

$$\int \sin ax dx = -\frac{1}{a} \cos ax + C \quad (\text{B-18})$$

B.2 General and Trigonometric Functions

$$\frac{d}{dx}(a) = 0 \quad (\text{B-28}) \quad \frac{d}{dx} \sin u = \cos u \frac{du}{dx} \quad (\text{B-34})$$

$$\frac{d}{dx}(ax) = a \quad (\text{B-29}) \quad \frac{d}{dx} \cos u = -\sin u \frac{du}{dx} \quad (\text{B-35})$$

$$\frac{d}{dx} \left(\frac{a}{x} \right) = -\frac{a}{x^2} \quad (\text{B-30}) \quad \frac{d}{dx} \tan u = \sec^2 u \frac{du}{dx} \quad (\text{B-36})$$

$$\frac{d}{dx} (ax^n) = nax^{n-1} \quad (\text{B-31}) \quad \frac{d}{dx} \cot u = -\operatorname{cosec}^2 u \frac{du}{dx} \quad (\text{B-37})$$

$$\frac{d}{dx} (au) = a \frac{du}{dx} \quad (\text{B-32}) \quad \frac{d}{dx} \sec u = \sec u \tan u \frac{du}{dx} \quad (\text{B-38})$$

$$\frac{d}{dx} (u^n) = nu^{n-1} \frac{du}{dx} \quad (\text{B-33}) \quad \frac{d}{dx} \operatorname{cosec} u = -\operatorname{cosec} u \cot u \frac{du}{dx} \quad (\text{B-39})$$

B.3 Leibnitz's Rule – Higher Derivatives of Products

$$D^n(uv) = uD^n v + \binom{n}{1}(Du)(D^{n-1}v) + \binom{n}{2}(D^2u)(D^{n-2}v) + \dots + vD^n u \quad (\text{B-40})$$

where

$$D^n = \frac{dn}{dx^n} = n^{\text{th}} \text{ differential operator}$$

$$\binom{n}{1}, \binom{n}{2}, \dots, \binom{n}{n} \text{ are binomial coefficients}$$

Example

$$D^3(uv) = u \frac{d^3v}{dx^3} + 3 \frac{du}{dx} \frac{d^2v}{dx^2} + 3 \frac{d^2u}{dx^2} \frac{dv}{dx} + v \frac{d^3u}{dx^3} \quad (\text{B-41})$$

B.4 Definition of a Derivative

$$\begin{aligned} \frac{dy}{dx} &= \frac{d}{dx} f(x) = f'(x) = y' \\ &= \lim_{\Delta x \rightarrow 0} \frac{f(x+\Delta x) - f(x)}{\Delta x}, \quad y = f(x) \end{aligned} \quad (\text{B-42})$$

B.5 Product Rule

$$\frac{d}{dx}(uv) = v \frac{du}{dx} + u \frac{dv}{dx} \quad (\text{B-43})$$

$$\frac{d}{dx}(uvw) = uv \frac{dw}{dx} + uw \frac{dv}{dx} + vw \frac{du}{dx} \quad (\text{B-44})$$

$$\frac{d}{dx}(u^n v^m) = u^{n-1} v^{m-1} \left(nv \frac{du}{dx} + mu \frac{dv}{dx} \right) \quad (\text{B-45})$$

B.6 Quotient Rule

$$\frac{d}{dx} \left(\frac{u}{v} \right) = \frac{v \frac{du}{dx} - u \frac{dv}{dx}}{v^2} \quad (\text{B-46})$$

$$\frac{d}{dx} \left(\frac{u^n}{v^m} \right) = \frac{u^{n-1}}{v^{m+1}} \left(nv \frac{du}{dx} - mu \frac{dv}{dx} \right) \quad (\text{B-47})$$

B.7 Chain Rule

$$\frac{d}{dx} f(u) = \frac{df(u)}{du} \frac{du}{dx} \quad (\text{B-48})$$

B.8 Exponential / Logarithmic Functions

$$\frac{d}{dx} \log_a u = \frac{\log_a e}{u} \frac{du}{dx} \quad (a \neq 0, 1) \quad (\text{B-49})$$

$$\frac{d}{dx} \ln u = \frac{1}{u} \frac{du}{dx} \quad (\text{B-50})$$

$$\frac{d}{dx} a^u = a^u \ln a \frac{du}{dx} \quad (\text{B-51})$$

$$\frac{d}{dx} e^u = e^u \frac{du}{dx} \quad (\text{B-52})$$

$$\frac{d}{dx} u^v = \frac{d}{dx} e^{v \ln u} = v u^{v-1} \frac{du}{dx} + u^v \ln v \frac{dv}{dx} \quad (\text{B-53})$$

B.9 Taylor's and Maclaurin's Theorems

Taylor's Theorem

$$\begin{aligned} f(x+h) &= f(x) + \frac{h}{1!} f'(x) + \frac{h^2}{2!} f''(x) \\ &+ \frac{h^3}{3!} f'''(x) + \dots + \frac{h^n}{n!} f^n(x) + \dots \end{aligned} \quad (\text{B-54})$$

$$f(x+h) = (x+h)^n = f(x) + \frac{h}{1!} f'(x) + \frac{h^2}{2!} f''(x) + \frac{h^3}{3!} f'''(x) + \dots$$

(B-55)

when h = 0

$$f(x) = x^n$$

$$f'(x) = nx^{n-1}$$

$$f''(x) = n(n-1)x^{n-2}$$

$$f'''(x) = n(n-1)(n-2)x^{n-3}$$

Substituting into the expansion for Taylor's expression

$$(x+h)^n = x^n + h \cdot nx^{n-1} + \frac{h^2}{2!} n(n-1)x^{n-2} + \frac{h^3}{3!} n(n-1)(n-2)x^{n-3} + \dots$$

(B-56)

and re-arranging gives the following

$$(x+h)^n = x^n + nx^{n-1}h + \frac{n(n-1)}{2!} x^{n-2} h^2 + \frac{n(n-1)(n-2)}{3!} x^{n-3} h^3 + \dots$$

(B-57)

Maclaurin's Theorem

Maclaurin's theorem is a special case of Taylor's theorem. If x= 0 and h is replaced by x, then Taylor's expansion becomes

$$f(x) = f(0) + \frac{x}{1!} f'(0) + \frac{x^2}{2!} f''(0) + \frac{x^3}{3!} f'''(0) + \dots + \frac{x^n}{n!} f^n(0) + \dots$$

(B-58)

Example: Expand log (1 + x)

Since f(x) = log (1 + x); f(0) = log (1)= 0

$$f'(x) = \frac{1}{1+x}; f'(0) = \frac{1}{1} = 1$$

$$f''(x) = -\frac{1}{(1+x)^2}; f''(0) = -\frac{1}{1} = -1$$

$$f'''(x) = \frac{1.2}{(1+x)^3}; f'''(0) = 1.2 = 2!$$

$$f^{iv}(x) = -\frac{1.2.3}{(1+x)^4}; f^{iv}(0) = -3!$$

$$f^n(x) = (-1)^{n-1} \cdot \frac{(n-1)!}{(1+x)^n}; f^n(0) = (-1)^{n-1} (n-1)!$$

Substituting these values in Maclaurin's theorem:

$$f(x) = \log(1+x) = f(0) + xf'(0) + \frac{x^2}{2!} f''(0) + \dots$$

we have:

$$\log(1+x) = x - \frac{x^2}{2} + \frac{x^3}{3} - \frac{x^4}{4} + \dots + (-1)^{n-1} x^n + \dots$$

Expand e^x

$$e^x = 1 + x + \frac{x^2}{2!} + \frac{x^3}{3!} + \frac{x^4}{4!} + \dots$$

B.10 Differential Equations

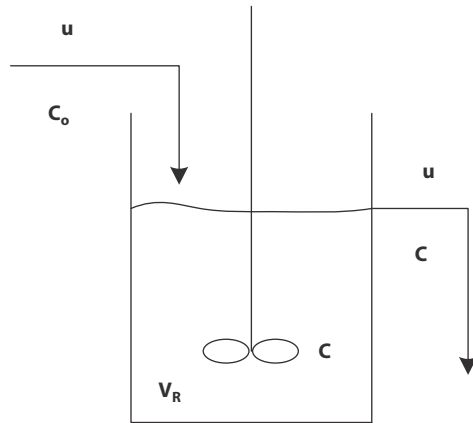
Separation of Variables

$$f(x)dy + g(x)dx = 0 \tag{B-59}$$

Solve by direct integration

$$\int f(x)dy + \int g(x)dx = C \tag{B-60}$$

Example : Continuous Flow Stirred Tank Reactor



u	= flow rate, l/s
V_R	= volume of tank, l
C_o	= inlet concentration, g/l
C	= tank and outlet concentration, g/l
t	= time, s

Determine C as a function of time.

Step 1. A mass balance on tank

Mass in - Mass out = Accumulation in tank.

$$u(C_o - C)dt = V_R dC \quad (\text{B-61})$$

Step 2. Separate C and t and integrate

$$\int \frac{dC}{C_o - C} = \frac{u}{V_R} \int dt \quad (\text{B-62})$$

$$-\ln(C_o - C) = \frac{ut}{V_R} + \ln A \quad (\text{B-63})$$

or

$$\ln(C_o - C) = \frac{-ut}{V_R} - \ln A \quad (\text{B-64})$$

$$C_o - C = -Ae^{-\frac{ut}{V_R}} \quad (\text{B-65})$$

Step 3. Determine A using the boundary condition

$$t = 0, \quad C = C_i, \text{ therefore } A = C_i - C_o$$

Step 4. The final solution is:

$$C_o - C = -(C_i - C_o)e^{-\frac{ut}{V_R}} \quad (\text{B-66})$$

or

$$C = C_o + (C_i - C_o)e^{-\frac{ut}{V_R}} \quad (\text{B-67})$$

Variable Separable

If it is possible to re-arrange the terms of the equation in two groups, each containing only one variable, the variables are said to be separable. Then the equation takes the form

$$f(y) \frac{dy}{dx} + f(x) = 0 \quad (\text{B-68})$$

or

$$f(y)dy + f(x)dx = 0 \quad (\text{B-69})$$

In which $f(x)$ is a function of x only, and $f(y)$ is a function of y only.

The general solution is:

$$\int f(y)dy + \int f(x)dx = C \quad (\text{B-70})$$

Example

Solve the differential

$$x dy + y dx = 0 \quad (\text{B-71})$$

dividing by xy ,

$$\frac{dy}{y} + \frac{dx}{x} = 0 \quad (\text{B-72})$$

$$\int \frac{dy}{y} + \int \frac{dx}{x} = 0 \quad (\text{B-73})$$

$$\ln y + \ln x = C_1 \quad (\text{B-74})$$

where the constant $C_1 = \ln C$

$$\ln y + \ln x = \ln C \tag{B-75}$$

giving

$$xy = C \tag{B-76}$$

The factor $\frac{1}{xy}$ used to multiply throughout to separate the variables is called an integrating factor.

Solve the Equation

$$(1 + x)ydx + (1 - y)x dy = 0$$

Multiplying throughout by $\frac{1}{xy}$, we have:

$$\frac{1+x}{x} dx + \frac{1-y}{y} dy = 0$$

or

$$\left(\frac{1}{x} + 1\right) dx + \left(\frac{1}{y} - 1\right) dy = 0$$

Therefore

$$\int \left(\frac{1}{x} + 1\right) dx + \int \left(\frac{1}{y} - 1\right) dy = C$$

Hence:

$$\log x + x + \log y - y = C$$

or

$$\log xy + (x - y) = C$$

B.11 Linear Equations

An equation of the form

$$\frac{dy}{dx} + Py = Q \tag{B-77}$$

is called a linear differential equation where P and Q are constants or functions of x only.

Multiplying such an equation throughout by the integrating factor $e^{\int P dx}$ gives an equation that can be solved.

$$e^{\int P dx} \left(\frac{dy}{dx} + Py \right) = Q e^{\int P dx} \tag{B-78}$$

Differentiating $y e^{\int P dx}$ gives

$$e^{\int P dx} \frac{dy}{dx} + e^{\int P dx} Py \tag{B-79}$$

which is the left – hand side of the equation

Therefore, the solution is:

$$y e^{\int P dx} = \int \left(Q e^{\int P dx} \right) dx \tag{B-80}$$

Example

Solve the equation

$$\frac{dy}{dx} + 2y = 0 \tag{B-81}$$

Integrating factor, $IF = e^{\int P dx} = e^{\int 2 dx} = e^{2x}$ (B-82)

Multiplying the equation by this integrating factor e^{2x} gives

$$e^{2x} \frac{dy}{dx} + 2e^{2x} y = 0 \tag{B-83}$$

Integrating this equation gives

$$y e^{2x} = A \tag{B-84}$$

where A is a constant

Therefore, the solution is

$$y = A e^{-2x} \tag{B-85}$$

B.12 Exact Differential Equation

If M and N are functions of (x, y) and

$$\frac{\partial M}{\partial y} = \frac{\partial N}{\partial x}$$

then $M dx + N dy = 0$ is an exact differential equation, the solution of which is

$$\int M dx + \int \left(N - \int \frac{\partial M}{\partial x} dx \right) dy + C = 0 \quad (\text{B-86})$$

or

$$\int N dy + \int \left(M - \int \frac{\partial N}{\partial y} dy \right) dx + C = 0 \quad (\text{B-87})$$

If the condition

$$\frac{\partial M}{\partial y} = \frac{\partial N}{\partial x}$$

is not satisfied, there exists a function $\psi(x, y) = \psi$ such that

$$\frac{\partial(\psi M)}{\partial y} = \frac{\partial(\psi N)}{\partial x}$$

B.13 Homogeneous Second Order Linear Differential Equation with Constant Coefficients

$$\frac{d^2 y}{dx^2} + a \frac{dy}{dx} + by = 0 \quad (\text{B-88})$$

First construct and solve the auxiliary equation

$$m^2 + am + b = 0 \quad (\text{B-89})$$

If the auxiliary equation has distinct real roots, m_1 and m_2 , then the solution is:

$$y = Ae^{m_1 x} + Be^{m_2 x} \quad (\text{B-90})$$

If the auxiliary equation has complex roots, $m_1 + im_2$ and $m_1 - im_2$, then the solution is:

$$y = e^{m_1 x} (A \cos m_2 x + B \sin m_2 x) \quad (\text{B-91})$$

If the auxiliary equation has two roots equal to m , then the solution is

$$y = (Ax + B)e^{mx} \quad (\text{B-92})$$

B.14 Table Of Laplace Transform

$\bar{f}(s)$	$f(t)$
$\frac{1}{s}$	1
$\frac{1}{s^2}$	t
$\frac{1}{s^n} (n=1, 2, \dots)$	$\frac{t^{n-1}}{(n-1)!}$
$\frac{1}{s-a}$	e^{at}
$\frac{1}{(s-a)^2}$	te^{at}
$\frac{1}{(s-a)^n} (n=1, 2, \dots)$	$\frac{1}{(n-1)!} t^{n-1} e^{at}$
$\frac{1}{s^2+a^2}$	$\frac{1}{a} \sin at$
$\frac{s}{s^2+a^2}$	$\cos at$
$\frac{1}{(s-a)^2+b^2}$	$\frac{1}{b} e^{at} \sin bt$
$\frac{1}{(s-b)^2+a^2}$	$\frac{e^{bt} \sin at}{a}$
$\frac{(s-a)}{(s-a)^2+b^2}$	$e^{at} \cos bt$
$\frac{(s-b)}{(s-b)^2+a^2}$	$e^{bt} \cos at$
$\frac{e^{-ks}}{s^2}$	$\begin{cases} 0 & \text{when } 0 < t < k \\ t-k & \text{when } t > k \end{cases}$

$$s\bar{f}(s) - f(0) \qquad \frac{df(t)}{dt}$$

$$s^2\bar{f}(s) - sf(0) - f'(0) \qquad \frac{d^2f(t)}{dt^2}$$

$$\frac{n!}{s^{n+1}} \text{ where } n \text{ is an integer} \qquad t^n$$

$$\frac{\Gamma(n)}{s^{n+1}} \text{ } n \text{ is not an integer} \qquad t^n$$

$$s^n\bar{f}(s) - \left[\begin{matrix} s^{n-1}f(0) + s^{n-2}f'(0) + \dots \\ +sf^{n-2}(0) + f^{n-1}(0) \end{matrix} \right] \qquad \frac{d^n f(t)}{dt^n}$$

where $f'(0), f''(0), \dots, f^{(n-1)}(0)$ are the values of the first, second, up to the $(n-1)^{\text{th}}$ derivative of the function when the independent variable is zero.

B.15 CUBIC EQUATIONS

An accurate solution of a cubic equation is essential in process engineering calculations. The commonly used Newton's method may be inadequate to establish the roots of a cubic equation. One root is always real and the other two roots can be real or imaginary depending on the equation.

General Procedure:

Consider the following cubic equation:

$$ax^3 + bx^2 + cx + d = 0 \qquad \text{(B-93)}$$

This reduces by the substitution

$$x = y - \frac{b}{3a} \text{ to } y^3 + py + q = 0 \qquad \text{(B-94)}$$

where

$$p = \frac{1}{3} \left[3\left(\frac{c}{a}\right) - \left(\frac{b}{a}\right)^2 \right] \qquad \text{(B-95)}$$

$$q = \frac{1}{27} \left[2\left(\frac{b}{a}\right)^3 - 9\left(\frac{b}{a}\right)\left(\frac{c}{a}\right) + 27\left(\frac{d}{a}\right) \right] \qquad \text{(B-96)}$$

$$y_1 = u + v$$

$$y_2 = \frac{(-u + v)}{2} + \frac{(u - v)}{2} i\sqrt{3}$$

$$y_3 = \frac{(-u + v)}{2} - \frac{(u - v)}{2} i\sqrt{3} \qquad \text{(B-97)}$$

$$D = \left(\frac{p}{3}\right)^3 + \left(\frac{q}{2}\right)^2 \qquad \text{(B-98)}$$

$$u = \sqrt[3]{\frac{-q}{2} + \sqrt{D}} \qquad v = \sqrt[3]{\frac{-q}{2} - \sqrt{D}} \qquad \text{(B-99)}$$

If a, b, c and d are real and if

- $D > 0$ there are one real and two conjugate imaginary roots.
- $D = 0$ there are three real roots of which at least two are equal
- $D < 0$, trigonometric formulas of the roots are

$$y_1 = 2\sqrt{\frac{|p|}{3}} \cos \frac{\phi}{3} \qquad \text{(B-100)}$$

$$y_2 = -2\sqrt{\frac{|p|}{3}} \cos \left(\frac{\phi + \pi}{3}\right) \qquad \text{(B-101)}$$

$$y_3 = -2\sqrt{\frac{|p|}{3}} \cos \left(\frac{\phi - \pi}{3}\right) \qquad \text{(B-102)}$$

The value of ϕ is calculated from the equation

$$\cos \phi = \frac{-q/2}{\sqrt{\frac{|p^3|}{27}}} \qquad \text{(B-103)}$$

The final roots are:

$$x_1 = y_1 - \frac{b}{3a} \quad (\text{B-104})$$

$$x_2 = y_2 - \frac{b}{3a} \quad (\text{B-105})$$

$$x_3 = y_3 - \frac{b}{3a} \quad (\text{B-106})$$

When $D \geq 0$, only one root is real

$$u_1 = -\frac{q}{2} + D^{0.5} \quad (\text{B-107})$$

If $u_1 < 0$, then

$$u = -|u_1|^{1/3} \quad (\text{B-108})$$

Else

$$u = u_1^{1/3} \quad (\text{B-109})$$

$$k_1 = -\frac{q}{2} - D^{0.5} \quad (\text{B-110})$$

If $k_1 < 0$, then

$$k = -|k_1|^{1/3} \quad (\text{B-111})$$

Else

$$k = k_1^{1/3} \quad (\text{B-112})$$

$$y_1 = u + k \quad (\text{B-113})$$

The final root is:

$$x_1 = y_1 - \frac{b}{3a} \quad (\text{B-114})$$

Useful Websites

www.integrals.com

<http://integrals.wolfram.com>

Appendix C

Physical and Chemical Characteristics of Major Hydrocarbons

Compound	Appearance/odor	Molecular Weight MW g/mol	Boiling Point BP °C	Freezing Point FP °C	Melting Point MP °C	Specific Gravity (20/20°C)	Flash Point °C	Flammability Or Explosive limit Lower/Upper Vol %	Auto-ignition Temperature °C
Ammonia, NH ₃	Colorless gas liquid with sharp, corrosive; pungent odor; flammable, lighter than air; toxic and irritant; tolerance 25 ppm in air	17	-33.4		-77.7	0.77		16 -25	650
Aniline, C ₆ H ₅ NH ₂	Colorless oily liquid; flammable; characteristic odor and burning taste; irritant; toxic; an allergen; tolerance 2 ppm in air, carcinogenic	93	184.1		-6.2	1.0216	70 (closed cup)	1.3/23	615
Asphalt	Brown - black solid or viscous liquid; sour odor; moderately toxic by inhalation of fumes		343	> 204	93	1.0	> 218		485

Physical and Chemical Characteristics of Major Hydrocarbons (Contd.)

Compound	Appearance/odor	Molecular Weight		Boiling Point °C	Freezing Point °C	Melting Point °C	Specific Gravity (20/20°C)	Flash Point °C	Flammability Or Explosive limit Lower/Upper Vol %	Auto-ignition Temperature °C
		g/mol	MW							
Benzene, C ₆ H ₆	Colorless to light yellow liquid with aromatic odor; extremely flammable, dangerous fire risks; tolerance limit in air 10 ppm, carcinogenic	78.11	78.11	80.1		5.5	0.879 (at 20/4°C) 0.8787 at 15°C	-11 (closed cup)	1.2/ 7.8	498
1,3 - butadiene, C ₄ H ₆ CH ₂ =CH-CH=CH ₂	Colorless gas, non-corrosive with mildly aromatic odor; highly flammable gas or liquid.	54	54	-4.4		-109	0.6211 (liquid at 20°C) 0.6149 at 25°C	-76.0	2 - 11.5	418.9
Butane, C ₄ H ₁₀	Colorless gas with natural gas odor; highly flammable, asphyxiant	58.124	58.124	-0.51	-138.36	-135	0.57 at 20/4°C	-60 (closed cup)	1.8/ 8.5	405
n- butanol, C ₄ H ₉ OH	Colorless liquid; flammable, toxic on prolonged inhalation; irritant to eyes; tolerance 50 ppm in air.	74.124	74.124	117.7		-89.5	0.810	28.9 (closed cup)	1.4/11.2	343
1-butene, C ₄ H ₈ CH ₃ CH ₂ CH=CH ₂	Colorless gas; highly flammable; dangerous fire and explosion hazard	56	56	-6.47		-185	0.5951 (at 20/4°C)	-80 TOC	1.6- 9.3	384

Physical and Chemical Characteristics of Major Hydrocarbons (Contd.)

Compound	Appearance/odor	Molecular Weight		Boiling Point °C	Freezing Point °C	Melting Point °C	Specific Gravity (20/20°C)	Flash Point °C	Flammability Or Explosive limit Lower/Upper Vol %	Auto-ignition Temperature °C
		g/mol	MW							
Carbon disulfide, CS ₂	Colorless or faintly yellow liquid; highly flammable; dangerous fire and explosion hazard	76.14		46.3		-111.6	1.260 (at 25/25°C) 1.2632	-30 (closed cup)	1.3 / 50	90
Carbon monoxide, CO	Colorless; highly toxic by inhalation; solidification point	28		-191.5		-206	0.967		12.5 - 74	605
Carbonyl sulfide, COS	Colorless gas with typical sulfide odor; extremely flammable, toxic, fire and explosion.	60		-50.2		-138	2.07		12 - 29	
Carbon tetrachloride, CCl ₄	Colorless liquid; toxic by ingestion inhalation; tolerance 5 ppm in air	153.82		76.0	-22.9	-22.6	1.595			> 982
Chloroform, CHCl ₃	Colorless, non flammable, heavy liquid with characteristic odor; toxic by inhalation; narcotic; prolong inhalation or ingestion may be fatal; tolerance 10 ppm in air, carcinogenic	119.38		61		-63.5	1.484			

Physical and Chemical Characteristics of Major Hydrocarbons (Contd.)

Compound	Appearance/odor	Molecular Weight	Boiling Point	Freezing Point	Melting Point	Specific Gravity	Flash Point	Flammability	Auto-ignition Temperature
Chloromethane, CH ₃ Cl	Colorless gas, ethereal odor, sweet taste; flammable; dangerous fire risk	50.49	-23.7	-97.6		0.92	0	8.1 - 17	632
Chloroprene, C ₄ H ₅ Cl	Colorless liquid; highly flammable; dangerous fire risk; toxic by ingestion and inhalation	88.5365	59.4		-130	0.9583	-15.6	1.2 - 13	
H ₂ C=CH-C(Cl)=CH ₂									
Cumene, (isopropyl benzene), C ₉ H ₁₂	Colorless liquid, aromatic odor; moderately toxic by ingestion; inhalation; flammable, tolerance 50 ppm in air	120.20	152.0		-96.03	0.8619 (at 20°C)	43	0.9 - 6.5	424
C ₆ H ₅ CH(CH ₃) ₂									
Cyclobutane (CH ₂) ₄	Colorless gas	56.107	12.5	-80	-91		10		
Cyclohexane, C ₆ H ₁₂	Colorless mobile liquid with pungent odor	84.16	80.74		6.47	0.779 (at 20/4°C)	-20	1.3 - 8.0	245
Cyclohexanol, C ₆ H ₁₁ OH	Colorless viscous liquid, hygroscopic, flammable, camphor-like odor	100.158	161.84		25.93	0.9429 (at 25/4°C)	67		300
Cyclopentane, C ₅ H ₁₀	Colorless liquid, highly flammable	70.1	49.2		-93.9	0.751	-37.2	1.1 - 8.7	361

Physical and Chemical Characteristics of Major Hydrocarbons (Contd.)

Compound	Appearance/odor	Molecular Weight		Boiling Point		Freezing Point		Melting Point	Specific Gravity	Flash Point	Flammability		Auto-ignition Temperature
		g/mol	MW	BP	°C	FP	MP				°C	(20/20°C)	
Cyclopentadiene, C ₅ H ₆	Colorless liquid; decomposes violently at high temperature; tolerance 75 ppm in air.	66.10		39- 43	°C	-90	°C	-90	0.786	25			
n-decane, C ₁₀ H ₂₂	Colorless liquid; moderate fire risk	142.29		173.8 to 174.4	°C	-30.5 to -29.2	°C	-30.5 to -29.2	0.729	46	0.8 – 2.6		210
Diacetone alcohol, C ₆ H ₁₂ O ₂ CH ₃ COCH ₂ C(CH ₃) ₂ OH	Colorless liquid with pleasant odor; flammable; dangerous fire risk; toxic and irritant; tolerance 50 ppm in air	116.16		166	°C	-47	°C	-47	0.9406 (at 20/20°C)	52	1.8 – 6.9		603
Di-n-butyl amine, (C ₄ H ₉) ₂ NH	Colorless oily liquid with amine odor	129.25		160	°C	-60 to -59	°C	-60 to -59	0.7577	40.5 (closed up)			255
Di-butyl maleate, (DBM)	Colorless oily liquid, ester – like odor	228.28		129	°C	-50	°C	-50	0.988	285			280
C ₁₂ H ₂₀ O ₄ C ₂ H ₂ (COOC ₄ H ₉) ₂													
Dicyclopentadiene, C ₁₀ H ₁₂	Chemical intermediate for pesticide; flammable; moderate fire risk; toxic by ingestion, inhalation; tolerance 5 ppm in air.	132.20		170	°C	32.5	°C	32.5	0.979	32	0.8 – 6.3		503

Physical and Chemical Characteristics of Major Hydrocarbons (Contd.)

Compound	Appearance/odor	Molecular Weight	Boiling Point	Freezing Point	Melting Point	Specific Gravity	Flash Point	Flammability	Auto-ignition Temperature
MW		g/mol	°C	°C	°C		°C	Lower/Upper Vol %	°C
Ethane, C ₂ H ₆	Colorless, odourless gas; severe fire risk, if exposed to sparks or open flame	30.07	-88.5		-182.8	0.446 (liquid, 0°C)	-135	2.9 - 13	472
Monoethanolamine (MEA), C ₂ H ₇ NO HOCH ₂ CH ₂ NH ₂	Colorless, hygroscopic; viscous liquid; moderately toxic. Unpleasant ammonia - like odor	61.08	170.0		10.3	1.0117	85	5.5 - 17	410
Diethanolamine, (DEA) C ₄ H ₁₁ NO ₂ HN(CH ₂ CH ₂ OH) ₂	Colorless crystal or viscous liquid, toxic; ammonia odor; tolerance in air 3 ppm	105.14	271.1		28	1.097	138	1.6 - 9.8	365
Triethanolamine (TEA), C ₆ H ₁₅ NO ₂ (HOCH ₂ CH ₂) ₃ N	Colorless viscous; hygroscopic liquid; combustible; low toxicity	149.19	335.40		21.60	1.124	179	1.3 - 8.5	325
Ethyl benzene, C ₈ H ₁₀ C ₆ H ₅ C ₂ H ₅	Colorless liquid with aromatic odor; flammable, dangerous fire risk, moderately toxic; tolerance 10ppm in air	106.17	136		-95	0.867 (20°C) 0.8665	22.22	1 - 7.8	430

Physical and Chemical Characteristics of Major Hydrocarbons (Contd.)

Compound	Appearance/odor	Molecular Weight		Boiling Point		Freezing Point		Melting Point		Specific Gravity (20/20°C)	Flash Point	Flammability Or Explosive limit Lower/Upper Vol %	Auto-ignition Temperature
		g/mol	MW	BP °C	FP °C	MP °C	°C	°C					
Ethanol, C ₂ H ₅ OH	Clear, colorless liquid with pungent burning odor; flammable, toxic and hazardous, dangerous fire risk; carcinogenic, tolerance in air 100 ppm	46.07		78.5		-114.14				0.7893 (25°C)	12.78 (closed cup)	3.3 / 19	363
Ethylene, C ₂ H ₄	Colorless, slightly sweet odor; highly flammable; liquid and vapor, dangerous fire and explosion risk.	28		-102.4		-169				0.975	-136.1 TCC	2.7 - 36	450
Ethylene oxide, C ₂ H ₄ O	Colorless gas; highly flammable; dangerous fire and explosion risk; asphyxiant, carcinogenic, tolerance 10 ppm in air.	44.052		10.4						0.871	-20	3 - 100	429
Ethylene dichloride, C ₂ H ₄ Cl ₂	Colorless oily liquid; highly flammable, dangerous fire risk; toxic by inhalation, ingestion; carcinogenic, tolerance limit in air 10 ppm	98.96		84		-35.5				1.2554	13	6	413

Physical and Chemical Characteristics of Major Hydrocarbons (Contd.)

Compound	Appearance/odor	Molecular Weight	Boiling Point	Freezing Point	Melting Point	Specific Gravity	Flash Point	Flammability		Auto-ignition Temperature
								Explosive limit	Or Vol %	
MW	g/mol	BP	FP	MP	(20/20°C)	°C	°C	Lower/Upper	°C	
Monoethylene glycol, MEG, CH ₂ OHCH ₂ OH	Colorless liquid with sweet taste; odorless, combustible; slightly flammable, toxic by ingestion and inhalation, carcinogenic.	62.07	197.3		-13.0	1.1088	111 (closed cup)	3.2 / 15.2	410	
Diethylene glycol, DEG, C ₄ H ₁₀ O ₃ , (CH ₂ CH ₂ OH) ₂ O	Colorless liquid, odorless, toxic	106.12	245		-8.0	1.12	138	2 / 12.3	227.78	
Triethylene glycol, TEG, HO(C ₂ H ₄ O) ₃ H	Colorless liquid, hygroscopic, slightly hazardous	150.18	285		-5	1.274	176.6	0.9 / 9.2	371	
Ethylene glycol Monobutyl ether, HOCH ₂ CH ₂ OC ₄ H ₉	Colorless liquid with mild odor; toxic; hygroscopic, tolerance limit in air 25 ppm	118.17	173	-70		0.9019	67	1.1 / 12.7	244	
Ethylene glycol Monoethyl ether, C ₄ H ₁₀ O ₂ CH ₃ CH ₂ OCH ₂ CH ₂ OH	Colorless liquid, moderately toxic by ingestion and inhalation; flammable liquid and vapor, tolerance limit 5 ppm in air	90.12	135	-70		0.931	44	1.7 - 15.6	235	
Formaldehyde, HCHO	Colorless gas, pungent suffocating odor, flammable	30.02	98	-15		1.08	50	6 / 36.5	430	
Gas oil, C ₉ - C ₂₀			160-400				> 60		350	

Compound	Appearance/odor	Molecular Weight	Boiling Point	Freezing Point	Melting Point	Specific Gravity	Flash Point	Flammability	Auto-ignition Temperature
Furfural, C ₃ H ₄ O ₂	Light – yellow to brown, Almond, pungent odor, toxic, absorbed by skin, tolerance 2 ppm in air, irritant to eyes, skin and mucous membrane	96.09	162		-39	1.16	60	2 / 19	315
Gasoline	Highly flammable, dangerous fire and explosion risk		39 - 200		-45.6	0.7 – 0.78	-43	1.4 / 7.6	> 280
n-heptane, C ₇ H ₁₆	Volatile, colorless liquid, flammable, dangerous fire risk, tolerance 400 ppm in air	100.21	98.4		-90.7	0.6838	-4.0 (closed cup)	1.05 / 6.7	203.89
Hexane, C ₆ H ₁₄	Colorless volatile liquid with faint odor; flammable, dangerous fire risk; tolerance 500 ppm in air	86.18	68		-95	0.66	-22.5	1.15 / 7.5	225

Physical and Chemical Characteristics of Major Hydrocarbons (Contd.)

Compound	Appearance/odor	Molecular Weight	Boiling Point	Freezing Point	Melting Point	Specific Gravity	Flash Point	Flammability		Auto-ignition Temperature
								Explosive limit	Lower/Upper Vol %	
MW	BP	FP	MP							
g/mol	°C	°C	°C	°C	(20/20°C)	°C	°C		Vol %	°C
Hydrazine, H ₂ N.NH ₂	Colorless, fuming, hygroscopic liquid; highly toxic by ingestion, inhalation and skin absorption; tolerance 0.1 ppm in air, a known carcinogen	32.05	113.5		1.4	1.004 (at 25/4°C)	52.5 (open cup) 37.78 (closed cup)	2.9 / 98	1.8 to 99.99	24 to 270
Hydrogen, H ₂	Highly flammable and explosive, dangerous when exposed to heat or flame	2	-252.879		-259.2	0.069		4 - 77		566
Hydrogen chloride, HCl	Colorless, fuming gas with suffocating odor; toxic by inhalation, strong irritant to eyes and skin. Tolerance in air 5 ppm	36.5	-85		-114	1.268				
Hydrogen cyanide, HCN	Colorless gas or liquid with characteristic odor; highly toxic by ingestion, inhalation and skin absorption	27.025	25.6		-14 to -12	0.687 (liquid at 20/4°C)	-17.8 (closed cup)	5.6 - 40.0		538

Physical and Chemical Characteristics of Major Hydrocarbons (Contd.)

Compound	Appearance/odor	MW	Boiling Point		Freezing Point		Melting Point	Specific Gravity (20/20°C)	Flash Point	Flammability Or Explosive limit Lower/Upper	Auto-ignition Temperature
			BP °C	FP °C	MP °C	Vol %					
Hydrogen sulfide, H ₂ S	Colorless gas with offensive (rotten eggs) odor; toxic by inhalation; highly flammable, chemical asphyxiant, irritant, dangerous fire risk; tolerance 10ppm in air.	34.08	-60	-86	-82	1.192				4.0 - 4.3 / 44 - 46	260
Isobutene, CH ₂ =C(CH ₃) ₂	Colorless volatile gas, extremely flammable	56	-6.9		-140.13	0.63		-80 (closed cup)		1.8	465
1,3 - Isobutadiene, C ₄ H ₆	Colorless gas, extremely flammable, asphyxiant, mildly aromatic	54	-4.4		-109	0.65		-76.1		2 - 11.5	418.9
Isopentane, C ₅ H ₁₂	Colorless liquid, pleasant odor; highly flammable.	72.15	27.85		-159.89	0.6197		< -51		1.3 - 7.6	420
CH ₃ CH(CH ₃)CH ₃											
Isophorone, C ₉ H ₁₄ O	Clear pale yellow liquid; toxic, irritant to skin and eyes, combustible liquid and vapor.	138.21	215.32	-8	-8	0.9220		84		0.8 / 3.8	460
C(O)CH-C(CH ₃) ₂											
CH ₂ C(CH ₃) ₂ CH ₂											
Isopropyl alcohol, C ₃ H ₇ OH	Colorless liquid, pleasant odor; highly flammable liquid and vapor, dangerous fire risk; toxic by ingestion and inhalation; tolerance 400 ppm in air.	60.10	82		-86	0.78634 (at 20/20°C)		12 (closed cup)		2.0 - 13	399

Physical and Chemical Characteristics of Major Hydrocarbons (Contd.)

Compound	Appearance/odor	Molecular Weight	Boiling Point	Freezing Point	Melting Point	Specific Gravity	Flash Point	Flammability	Auto-ignition Temperature
Kerosene	Yellow color, moderate fire and explosion risks, moderately toxic by inhalation, flammable.		149			0.775 - 0.84	37.7 - 65.8	0.7 / 5 - 7	210
Methane, CH ₄	Colorless, odorless, tasteless gas, extremely flammable	16.04	-161		-182	0.554			600
Methyl isobutyl ketone (MIBK) C ₆ H ₁₂ O	Colorless, flammable liquid and vapor; highly active solvent, camphor - like odor.	100.16	115.9		-84	0.802	14 (closed cup)	1.4 / 7.5	460
Methanol, CH ₃ OH	Clear, colorless mobile liquid	32.04	64.5		-97.8	0.7915	12 (closed cup)	6 / 36.5	464
Methyl chloride, CH ₃ Cl	Colorless gas, faint sweetish odor, extremely flammable, toxic, carcinogenic, irritant	50.49	-23.7		-97	0.92		8.1 / 17	632
Methyl cyclo hexane, C ₇ H ₁₄ , CH ₃ C ₆ H ₁₁	Colorless liquid, irritant	98.19	100.9		-126.	0.7694	0.38	1.2 / 6.7	250
Methyl tert - butyl ether (MTBE), C ₅ H ₁₂ O (CH ₃) ₃ COCH ₃	Colorless pungent odor, irritant, extremely hazardous.	88.15	55.2		-109	0.7405	-28 (closed cup)	2.5 / 15.1	224
Methyl ethyl ketone (MEK), C ₄ H ₈ O CH ₃ COCH ₂ CH ₃	Colorless liquid, flammable, dangerous fire risk. Acetone-like pleasant, pungent odor	72.12	79.6		-86	0.805	-9 (closed cup) -5.5 (open cup)	1.8 / 10	404

Physical and Chemical Characteristics of Major Hydrocarbons (Contd.)

Compound	Appearance/odor	Molecular Weight		Boiling Point °C	Freezing Point °C	Melting Point °C	Specific Gravity (20/20°C)	Flash Point °C	Flammability Or Explosive limit Lower/Upper Vol %	Auto-ignition Temperature °C
		MW g/mol	BP °C							
N - methyl Pyrrolidone, (NMP), C ₅ H ₉ NO	Colorless liquid, irritant, toxic, slightly hazardous	99.14	202	-24	-	-24	1.026	92.778 (closed cup)	1.3 / 9.5	346.11
Naphthalene, C ₁₀ H ₈	White solid crystals, odor of coal tar, highly flammable, irritant, slightly hazardous	128.19	218	80.2	-	80.2	1.162	95.556 (open cup) 88 (closed cup)	0.9 / 5.9	567
Nitrobenzene, C ₆ H ₅ NO ₂	Oily liquid, greenish yellow crystals.	123.11	210.8	5.7	-	5.7	1.2	87.78 (closed cup)	1.8	482
n-nonane, C ₉ H ₂₀	Colorless liquid, irritant, slightly hazardous	128.26	151	-53.5	-	-53.5	0.714	31 (closed cup)	-	205
n-octane, C ₈ H ₁₈	Colorless liquid, irritant, slightly hazardous.	114.23	125.6	-56.7	-	-56.7	0.7028	13.33	1 / 6.5	206
n-pentane, C ₅ H ₁₂	Colorless liquid with pleasant odor, highly flammable, irritant.	72.15	36.1	-130	-	-130	0.6262	-49	1.5 / 7.8	260
Phenol, C ₆ H ₅ OH	White, crystalline mass, burning taste, distinctive odor, corrosive, irritant, very hazardous	94.11	182	42	-	42	1.057	79 (closed cup) 85 (open cup)	1.7 / 8.6	715

Physical and Chemical Characteristics of Major Hydrocarbons (Contd.)

Compound	Appearance/odor	Molecular weight	Boiling Point	Freezing Point	Melting Point	Specific Gravity	Flash Point	Flammability	Auto-ignition Temperature	
										MW
m - xylene, 1,3 Dimethyl benzene $C_6H_4(CH_3)_2$	Colorless liquid, flammable liquid and vapor	106.17	139		-48	0.8684 (at 20/4°C)	27	1.1 / 7.0	527.7	
o - xylene 1,2 Dimethyl benzene $C_6H_4(CH_3)_2$	Colorless liquid, highly flammable	106.17	144.4		-25	0.88 (at 20/4°C)	17 (closed cup)	0.9/6.7	463	
p - xylene 1,4 Dimethyl benzene $C_6H_4(CH_3)_2$	Colorless liquid, aromatic odor, flammable liquid and vapor	106.17	138.35		13.2	0.861 (at 20/4°C)	27.2 (TOC)	1.1 / 6.7	528	
Styrene, C_8H_8 $C_6H_5CH=CH_2$	Colorless oily liquid, flammable, toxic and carcinogenic, risk to fire and explosion	104.14	145.2		-30.6	0.906	31.1 (closed cup)	1.1/6.1	490	

Appendix D

A List of Engineering Process Flow Diagrams and Process Data Sheets

D-1 Process Flow Diagrams Using Visio 2002 Software

Figure D-1. Process flow diagram (Feed and fuel desulfurization section).

Figure D-2. Typical process flow diagram for the production of Methyl Tertiary Butyl Ether (MTBE).

Figure D-3. Piping and instrumentation diagram for Ammonia plant CO₂ removal.

Figure D-4. Piping and instrumentation diagram Ammonia synthesis and refrigeration unit.

D-2 PROCESS DATA SHEETS

1. Air cooled heat exchanger process data sheet
2. Centrifugal pump schedule: driver
3. Centrifugal pump schedule: pump
4. Centrifugal pump summary
5. Column schedule
6. Deaerator process data sheet: Deaerated water storage tank
7. Deaerator process data sheet: Deaerator head
8. Drum process data sheet
9. Effluent schedule
10. Equilibrium flash calculation
11. Fabricated equipment schedule
12. Fan/Compressor process duty specification
13. Fractionator calculation summary
14. General services and utilities checklist
15. Hazardous chemical and conditions schedule
16. Heat and mass balances
17. Heat exchanger rating sheet
18. Hydrocarbon dew point calculation
19. Line list schedule
20. Line schedule
21. Line schedule sheet
22. Line summary table
23. Mass balance
24. Mechanical equipment schedule
25. Pipe line list
26. Pipe list
27. Piping process conditions summary
28. Plate heat exchanger data sheet
29. Calculation of pressure drop in fixed catalyst beds
30. Process engineering job analysis summary
31. Pump calculation sheet
32. Pump schedule
33. Relief device philosophy sheet
34. Tank and vessel agitator data sheet
35. Tank process data sheet
36. Tank schedule
37. Tie-in-schedule
38. Tower process data sheet
39. Tray loading summary
40. Trip schedule
41. Utility summary sheet
42. Vessel and tank schedule
43. Vessel and tank summary: driver
44. Vessel schedule
45. Water analysis sheet

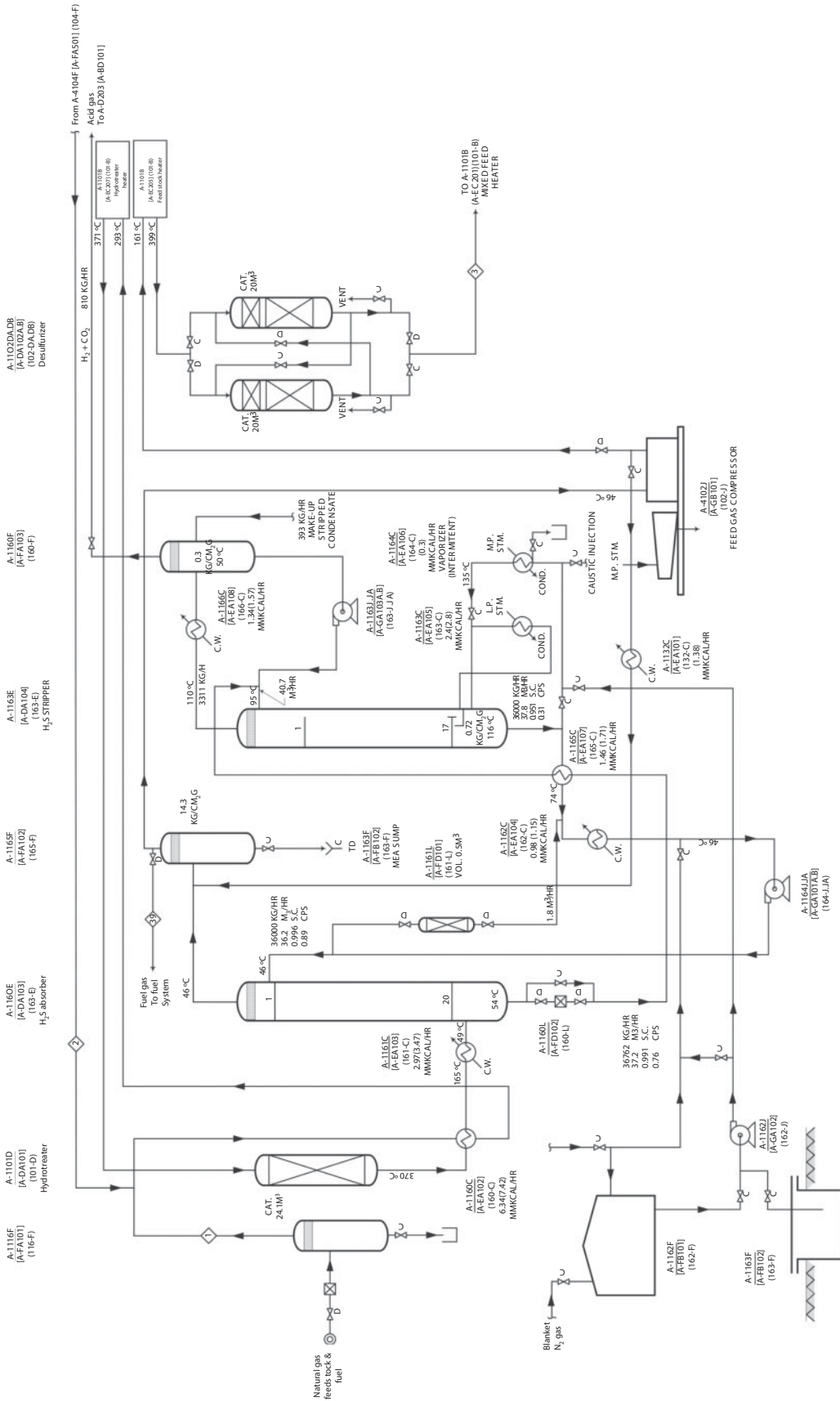


Figure D-1 Process flow diagram (Feed and fuel desulfurization section).

ITEM NO.	1-E-301
SERVICE	1P STEAM CONDENSER
IN. SURFACE	36.00
OUT. SURFACE	36.00
DESIGN PRESS.	3.00 PSIA
DESIGN TEMP.	200 °F
INSULATION	30 PPT/1.00 IN.

ITEM NO.	1-E-302
SERVICE	1P STEAM CONDENSER
IN. SURFACE	36.00
OUT. SURFACE	36.00
DESIGN PRESS.	3.00 PSIA
DESIGN TEMP.	200 °F
INSULATION	30 PPT/1.00 IN.

ITEM NO.	1-E-303
SERVICE	1P STEAM CONDENSER
IN. SURFACE	36.00
OUT. SURFACE	36.00
DESIGN PRESS.	3.00 PSIA
DESIGN TEMP.	200 °F
INSULATION	30 PPT/1.00 IN.

ITEM NO.	1-E-304
SERVICE	1P STEAM CONDENSER
IN. SURFACE	36.00
OUT. SURFACE	36.00
DESIGN PRESS.	3.00 PSIA
DESIGN TEMP.	200 °F
INSULATION	30 PPT/1.00 IN.

GENERAL NOTE:
 1. EACH INSTRUMENT TAG NUMBER SHALL HAVE THE UNIT PREFIX 'U'.

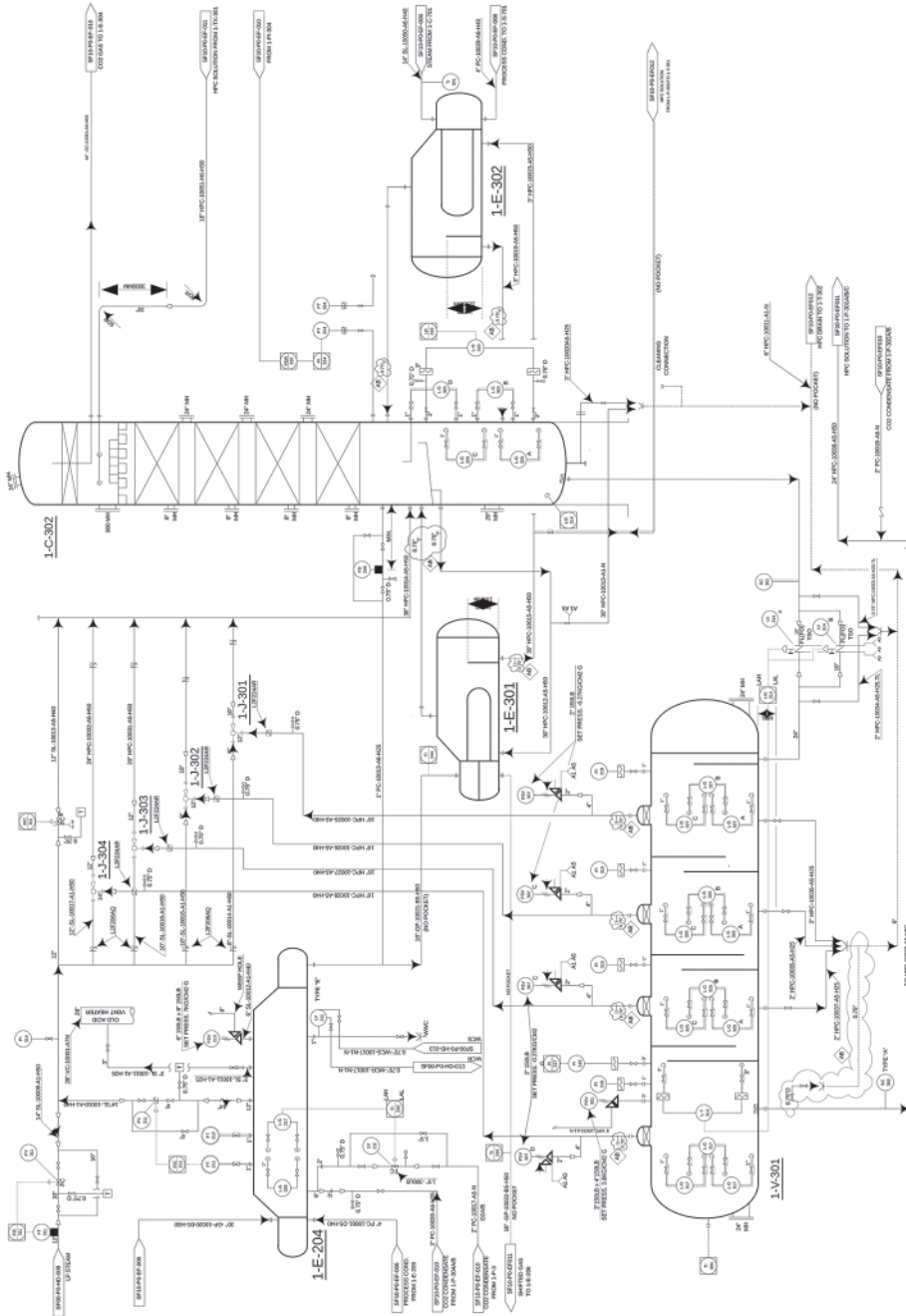


Figure D-3 Piping & Instrumentation Diagram for Ammonia Plant CO2 Removal.

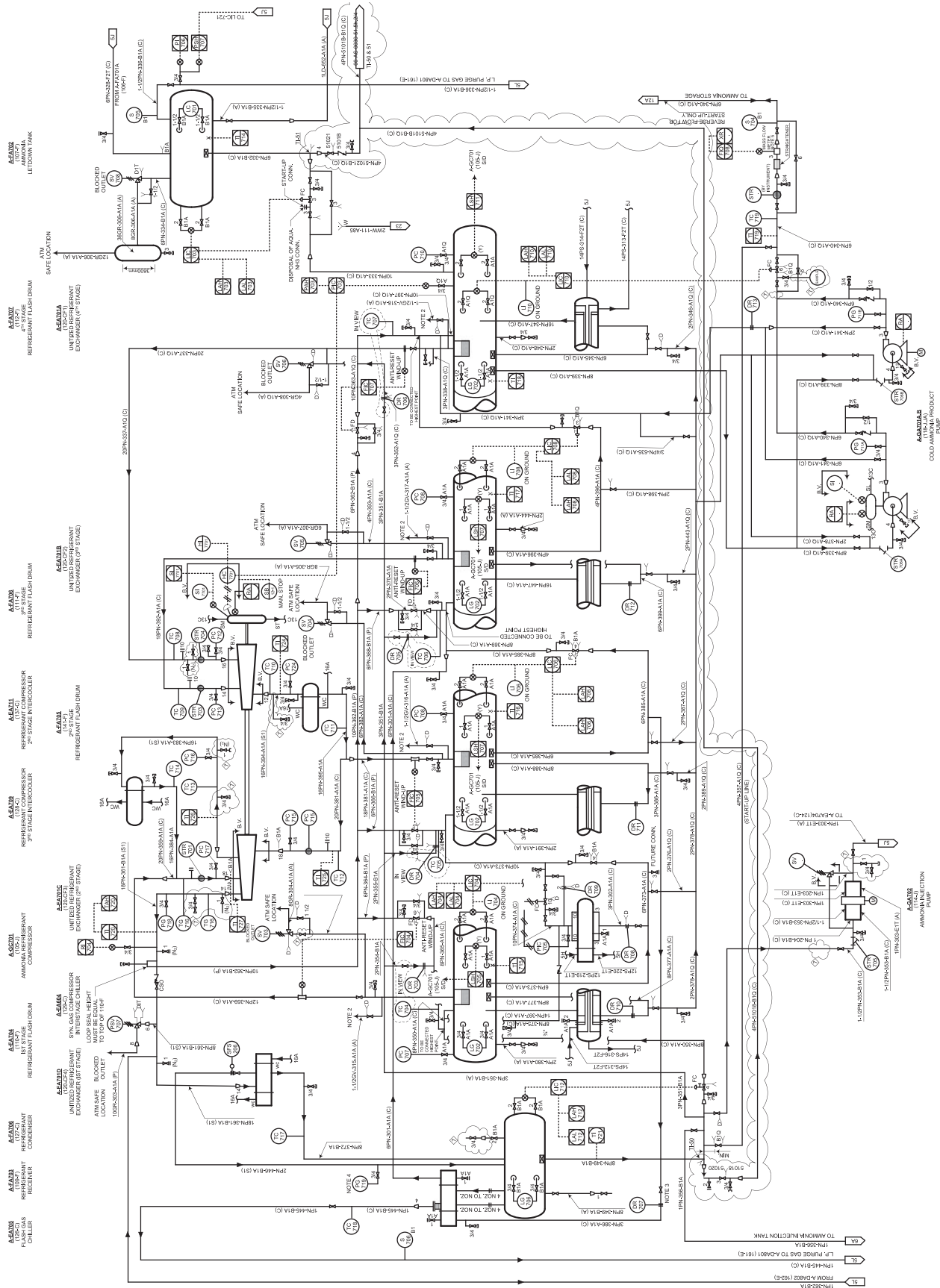





Figure D-4 Piping and instrumentation diagram: Ammonia synthesis and refrigeration unit.

		DRUM PROCESS DATA SHEET	Doc. No: Item No. Sheet of
		Job:	
Distribution:	Item Name:		
	NOTE: * indicates delete as necessary; ** indicates for other than Code reason		
5			
10			
15			
20			
25			
26	Shell Diameter (OD/ID):	Shell Length:	No. Required:
27	Centre Line*: Horizontal/Vertical		
28	Pressure: g	Temperature: °F/°C	Nozzles
29	Item Number		Inlet
30	Operating		
31	Design		Vapor Out
32	Emergency Vacuum Design*: Yes/No		
33	Material	Corr. Allowance	Liquid Out:
34	Shell		
35	Heads		
36	Liner		Thermocouple
37	Type of Heads		Pressure Gauge
38	Code:		Gauge Glass
39	Stress Relieve**:	Radiography**:	Level Control
40	Joint Efficiency:		Safety Valve
41	Density of Contents:	at *°F/°C	
42	Weight Empty:	Weight Full:	
43	Is vessel subject to mechanical vibration ? *Yes/No		Vent
44	Insulation: Type*: Frost and Personnel Protection/Cold		Drain
45	*Yes/No /Anticondensation/Heat Conservation		Steam Out
46	REMARKS:		
47			Manhole
48			
49			
50			
51			Min. Base Elev'n:
52			Material:
53	Issue No.	1	Date
54	Made/Revised by		
	Checked by		
	Approved Process		
	Approved by		


Job No.			Description			Issue No.:			Sheet	of	1	2	3	Date
									No.	No.	No.	Date	Date	Date
Item No.	No.	Description	Diameter (m)	Length (m)	Surface (m ² /Shell)	Weight (kg/Shell)	Internals/ H.E. Type (See Note 1)	Fluid	Material	Design Pressure (kg/cm ² g)	Conditions Temperature (°C)	Remarks		
OFF	OFF							T = Tube S = Shell						
								T						
								S						
								T						
								S						
								T						
								S						
								T						
								S						
								T						
								S						
								T						
								S						
								T						
								S						
								T						
								S						
								T						
								S						
								T						
								S						
								T						
								S						
								T						
								S						
								T						
								S						
								T						
								S						
								T						
								S						
								T						
								S						
								T						
								S						
								T						
								S						
								T						
								S						
								T						
								S						
								T						
								S						
								T						
								S						
								T						
								S						

Notes: 1. H.E. = Type Coding - A.C. = Air Cooler; K = Kettle; U.B. = U-Tube Bundle; F.H. = Floating Head; F.T.S. = Fixed Tube Sheet

		FRACTIONATOR CALCULATION SUMMARY	Job No: Item No: Sheet ____ of ____										
	Job: _____												
Distribution	Item Name: _____												
	1 Operate at _____	psig	Units: Metro/British (delete one)										
	2 Fractionation: _____	Reflux Ratio & No. of Plates:											
	3 Ovhd Prod: C <	Reflux Ratio:	Actual: _____	; Use									
	4 Bottoms: C <	Rectifying Plates:	Theoretical: _____	; Use									
	5	Stripping Plates:	Theoretical: _____	; Use									
	6	Feed		Net Bottoms									
	7	Component	Mol	Mol %	Mol	Mol %	K	$\frac{K_{sc} \text{ } ^\circ\text{C}}{\text{psia } ^\circ\text{F}}$	KX	Pat	$^\circ\text{C}$	Vapor Pressure	
	8										$^\circ\text{F}$		
	9	1											
	10	2											
	11	3											
	12	4											
	13	5											
	14	6											
	15	7											
	16	8											
	17	9											
	18	10											
	19												
	20	Net Overheads				Ext. Rflx		Gross Overheads					
	21	Component	Mol	Mol %	K	$\frac{K_{sc} \text{ } ^\circ\text{C}}{\text{psia } ^\circ\text{F}}$	KX or $\frac{Y}{K}$	Mol	Mol	Mol %	K	$\frac{K_{sc} \text{ } ^\circ\text{C}}{\text{psia } ^\circ\text{F}}$	$\frac{Y}{K}$
	22												
	23	1											
	24	2											
	25	3											
	26	4											
	27	5											
	28	6											
	29	7											
	30	8											
	31	9											
	32	10											
33													
34	Thermal Conditions of Feed:				Reboiler Vapor Quantity:								
35													
36													
37													
38													
39													
40													
41	Stream	$^\circ\text{API}$	sp gr at 15 $^\circ\text{C}$ at 60 $^\circ\text{F}$	Temp. $^\circ\text{C}$ $^\circ\text{F}$	sp gr at T $^\circ$	Sp. Vol. at T $^\circ$ m ³ /kg Ft ³ /lb		Mol/h	Mol Wt	kg/h lb/h			
42													
43													
44	Feed												
45	Net Bottoms												
46	Net Overheads												
47	Gross Overheads												
48	Gross Bottoms												
49	Reboiler Vapor												
50													
51													
52													
53	REMARKS												
54													
55		Issue No.	1	Date	2	Date	3	Date					
56		Made/Revised by											
57		Checked by											
58		Approved Process											
59		Approved by											


 GENERAL SERVICES AND UTILITIES CHECKLIST					
Job No.:				Sheet of	PREPARED BY: DATE:
Job Name:					
Document No					
Project No.					
Client					
Plant					
SERVICE	SUSTAINED	QUANTITY PEAK	UNIT	OPERATING PRESSURE AND TEMPERATURE	REMARKS
ELECTRICAL 13.8 KV			KVA		
ELECTRICAL 2300 V			KVA		
ELECTRICAL 440 V			KVA		
MISC. LIGHTING, ST. ETC.,] (110 V)			KVA		
WELL WATER (CITY)			gpm		
SEA WATER			gpm		
RIVER WATER - PROCESS			gpm		
RIVER WATER - FIRE PROT.			gpm		
FUEL GAS			SCFM		
ODORIZED GAS			SCFM		
COMPRESSED AIR			SCFM		
STEAM			lb/h		
(400 OR 475) Psig			lb/h		
235 Psig			lb/h		
150 Psig			lb/h		
50 Psig			lb/h		
CONDENSATE RETURN			lb/h		
CONDENSATE USAGE			lb/h		
PROCESS TRANSFER AND RAW MATERIALS					
CAUSTIC (-%)			lb/h		
BRINE (-%)			lb/h		
LPG (-%)			lb/h		
SITE DEV. (AREA FILL)					
RAIL ROADS					
BLOCK ACCESS ROADS					
SANITARY SEWERS			gpm		
			gpm		
WASTE WATER					

* ASSUME 1 HORSE POWER = 1 KVA
 NOTE: ONE COPY OF THIS LIST TO BE GIVEN TO SERVICE AND UTILITY SECTION.


		HYDROCARBON DEWPOINT CALCULATION						Job No: _____								
								Item No. _____								
		Job: _____						Page of _____								
		Pressure: _____ Convergence Pressure: _____ psia														
		Heaviest Compound: PROPANE														
y	Tb	LIGHT COMPONENT		HEAVY COMPONENT		ASSUMED TEMPERATURE										
		Fe _L	TbFe _L	Fe _H	TbFe _H	°F		°F		°F		°F		°F		
						K	y/K	K	y/K	K	y/K	K	y/K		x	
H ₂	67	1.000	67.000													
N ₂	130	0.0229	2.972	0.105	13.61											
CO	172	0.0046	0.797	0.180	31.00											
CH ₄	201	0.0019	0.383	0.244	49.02											
C ₂ H ₄	305			0.548	167.0											
CO ₂	330			0.638	210.6											
C ₂ H ₆	332			0.646	214.3											
C ₂ H ₂	340			0.676	229.9											
C ₃ H ₆	406			0.954	387.3											
C ₃ H ₈	416			1.000	416.0											
		1.000		Σ y/K												1.000
				x for H ₂												
				Σ (yFe _L /K)												
				Σ (yFe _H /K)												
				E.B.PL												
				E.B.PH												
				P _g												
				Estimate of Dewpoint: _____ °F at Estimate P _g of: _____ psia												
Issue No.	1	Date	2	Date	3	Date										
Made/Revised by																
Checked by																
Approved Process																
Approved by																

KAZ LINE LIST SCHEDULE																		
Job No.:			Sheet of			1			Date			Date						
Job Name:						2			Date			Date						
Document No.						3			Date			Date						
Project No.						4			Date			Date						
Client:						5			Date			Date						
Location:						6			Date			Date						
Plant:						7			Date			Date						
ISS	LINE No.	COLUMN	LINE ROUTING		PLANT CONDITION	OPERATING		DESIGN		INSULATION		FIELD TEST		REMARKS		FIELD No.	ISC DRG. No.	
			FROM	TO		PHASE	PIPE SIZE	ELUID SPEC.	PIPE SIZE	DENSITY	TEMP.	PRESS.	TEMP.	PRESS.	TEMP.			NOM. THICK
DATA CHANGES																		

UNITS: PRESSURE: bar psi kg/cm² g TEMPERATURE: °C °F NOMINAL PIPE SIZE: in. mm Insulation Thickness: in. mm

		PLATE HEAT EXCHANGER DATA SHEET		Document No.		
				Sheet of		Rev.
Job		Item No.(s)				
Item Name		No. Working			Total No. Off	
1	PROCESS DESIGN	UNITS		FLUID 1	FLUID 2	FLUID 3
2	Fluid Circulated	-				
3	Total Fluid Entering (Normal)	kg/h				
4	Flow Margin	%				
5	Inlet Vapor and Gas (&MW)	kg/h				
6	Inlet Liquid	kg/h				
7	Fluid Vaporized/Condensed (&MW)	kg/h				
8	Temperature In/Out	°C				
9	Max. Pressure Drop	bar				
10	Inlet Pressure (Operating)	barg				
11	Normal Heat Load	kW				
12	Heat Load Margin	%				
13	Fouling Resistance	m ² °C/W				
14	FLUID PROPERTIES					
15	Specific Heat	kJ/kg°C				
16	Thermal Conductivity	W/m°C				
17	Density	kg/m ³				
18	Viscosity	cP				
19	Liquid Viscosity (at Temp.)	cP				
20	Latent Heat	kJ/kg				
21	ENGINEERING DESIGN					
22	Process Design Pressure	barg				
23	Process Design Temperature	°C				
24	Corrosion Allowance (Header)	mm				
25	Line N.B. In/Out	in.				
26	Minimum Flow Passage	mm				
27	Plate Material					
28	Frame Material					
29	Gasket Material					
30	Design Code					
31	NOTES					
32						
33	1. Unless otherwise stated fluid properties are for mean fluid temperatures.					
34	2. Sour Service Yes /No					
35						
36						
37						
38						
39						
40						
41						
42						
43						
44						
45						
46						
47						
48						
49						
50						
51						
52						
53						
	1	Date	2	Date	3	Date
Description						
Made/Revised by						
Checked by						
Approved Process						
Approved by						

Made _____
 Checked _____
 Date _____

	<h2 style="margin: 0;">PROCESS DATA SHEET</h2>	Job No. _____ <hr/> Item No. _____ <hr/> Sheet of _____
Job _____		

CALCULATION OF PRESSURE DROP IN FIXED CATALYST BEDS

REQUIRED DATA

VESSEL NO: _____
 SERVICE: _____
 CATALYST: _____

VOLUME REQUIRED _____ V _____ ft³
 MANUFACTURER & NO. _____
 DIMENSIONS _____
 EQUIV. PARTICLE DIA. _____ D_p _____ ft
 SHAPE/SIZE FACTOR _____ S_f _____

GAS DATA: FLOW RATE _____ W _____ lb/h
 _____ W² _____ (lb/h)²
 MIN. MOLECULAR WEIGHT _____
 BED OUTLET PRESSURE _____ P _____ psia
 MAX. BED TEMPERATURE _____ °C
 ABS. TEMPERATURE (K = °C + 273) _____ T _____ K


CALCULATION


$$k_1 \frac{(T)(S_f)}{(M)(P)} = \frac{\quad}{\quad} = \quad$$

	SYMBOLS	UNITS	CALCULATION	CASE 1	CASE 2	CASE 3	CASE 4
BED DIAMETER	D	ft					
BED C.S.A.	A	ft ²	0.7854D ²				
BED DEPTH	L	ft	V/A				
SUPERFICIAL MASS FLOW	G	lb/h ft ²	W/A				
MASS FLOW FACTOR	G _f	-					
D _p G		-					
REYNOLDS NO. FACTOR	Re _f	-					
k ₂	k ₂	-	k ₁ Re _f				
CLEAN PRESSURE DROP/UNIT DEPTH	ΔP _c	psi/ft	k ₂ G _f				
CLEAN OVERALL PRESSURE DROP	ΔP _c	psi/ft	LΔP _c				
SAFETY/FOULING FACTOR	f	-		1.25/			
FLOW SHEET PRESSURE DROP	R	psi	fΔP _c				

* IF VALUE OF D_pG > 200 (750 FOR RING CATALYSTS)
 IF VALUE OF D_pG < 200 (750 FOR RING CATALYSTS) CALCULATE $Re = D_p G / \infty$
 (WHERE ∞ = DYNAMIC VISCOSITY OF GAS, lb/ft h)

	1	Date	2	Date	3	Date
Description						
Made/Revised by						
Checked by						
Approved Process						
Approved by						

		PROCESS ENGINEERING JOB ANALYSIS SUMMARY	
Job Title			
Job No.		Charge No.	Date
Based Upon Cost Estimated Dated		or Actual Construction Cost	
Summary Prepared By		Information Dated	
Production Basis (lb/day, tonnes/day, lb/month)			
SERVICE REQUIREMENTS:		UNIT RATE	UNIT RATE/ PRODUCTION BASIS
1	Steam (30 lb)	lb/h	
2	Steam (150 lb)	lb/h	
3	Steam (400 lb)	lb/h	
4	Steam (lb)	lb/h	
5	Treated R.W.	gpm	
6	Untreated R.W.	gpm	
7	Fresh Water	gpm	
8	Sea Water	gpm	
9	Fuel Gas (psi)	cfm (60° F and 1atm)	
10	Air (psi)	cfm (60° F and 1atm)	
11	Power ()		
12	Horsepower		
13	Condensate	lb/h	
14			
RAW MATERIALS		UNIT RATE	
1	Chlorine		
2	Hydrogen (%)		
3	Caustic (%)		
4	Salt		
5	Sat. Brine		
6	Natural Gas		
7	Air		
8	Ethylene		
9			
10			
11			
PRODUCTS AND BY- PRODUCTS		UNIT RATE	
1	Chlorine		
2	HCl (%)		
3	Salt (%)		
4	Caustic (%)		
5	Ammonia (%)		
6	H ₂ SO ₄ (%)		
7	Gas ()		
8			
9			
10			
11			

		PUMP CALCULATION SHEET			Document No.						
Job Item Name.					Sheet of Rev.						
					Item No. (s)						
					No. Working	Total No. off					
		UNITS		CASE I	CASE II	SKETCH OF PUMP HOOK-UP					
1											
2	Liquid Pumped										
3	Corrosion/Erosion										
4	Due To										
5	Operating Temp. (T)	° C	° F								
6	Specific Gravity at T										
7	Viscosity	cP	cP								
8	Vapor Pressure at T	bara	psia								
9	Normal mass Flowrate	kg/h	lb/h								
10	Normal Vol. Flowrate	m ³ /h	USgpm								
11	Min. Vol. Flowrate										
12	Design Vol. Flowrat	m ³ /h	gpm								
13 SUCTION CONDITION											
14	Pressure at Equipment	barg	psig	+	+						
15	Static Head	bar	psi	+ / -							
16	Total - Lines 14 + 15	bar	psi	+	+						
17	Suction Line ΔP	bar	psi	-	-						
18	Filter/Strainer ΔP	bar	psi	-	-						
19											
20	Total Suction Pressure	barg	psig	+	+						
21 DISCHARGE CONDITION											
22	Pressure at Equipment	barg	psig	+	+						
23	Static Head	bar	psi	+ / -	+ / -						
24											
25	Exchanger ΔP	bar	psi	+	+						
26											
27	Furnace ΔP	bar	psi	+	+						
28	Orifice ΔP	bar	psi	+	+						
29	Control Valve ΔP	bar	psi	+	+						
30											
31	Line ΔP	bar	psi	+	+						
32											
33	Total Discharge Press.	barg	psig	+	+						
34	Differential Pressure	bar	psi								
35	Differential Head	bar	psi								
36 NPSH											
37	Total Suction Pressure	bara	psia								
38	Vapor Pressure	bara	psia								
39	NPSH - Lines 37 - 38	bara	psia								
40	=	m	ft								
41	Safety Margin	m	ft								
42	NPSH - Lines 40-41	m	ft								
43	Hydraulic Power	kW	Hp								
44	Estimated Efficiency	%	%								
45	Estimated Abs. Power	kW	Hp								
46	Type of Pump										
47	Drive										
48											
49	Material - Casing										
50	- Impeller										
51	- Shaft										
52											
53	Sour Service	Yes/No									
54 HEAD m = 10.2 × bar/SG m = 10 × kg/cm ² /SG ft = 2.31 × psi/SG											
55 VOLUME m ³ /h × SG × 1000 = kg/h USgpm × SG × 600 = lb/h											
56 POWER kW = m ³ /h × bar/36.0 kW = m ³ /h × kg/cm ² /36.71 Hp = USgpm × psi / 1714											
57		1	Date	2	Date	3	Date	4	Date	5	Date
58	Description										
59	Made/Revised by										
60	Checked by										
61	Approved Process										
62	Approved										


NOTES


1. Pump shut-off head not to exceed.....
2. Relief valve on pump discharge to be set at
3. Pump case design pressure.....
design temperature.....
4. Sealing/flushing fluid available:
5. Cooling medium available:
6. Insulation required:
7. Start-up/commissioning fluid SG.

PUMP SCHEDULE		1	2	3	Date
Job No.:					Date
Job Name:					
Document No.					
Project No.					
Client					
Location					
Plant					
1 Item Number.					
2 Item Name					
3 Number Off. No. Running/Total Installed					
4 Preferred Type	Units				
5 Liquid Pumped					
6 Operating Temperature	° C				
7 Specific Gravity at Operating Temperature					
8 Viscosity at Operating Temperature	cP				
9 Vapor Pressure at Operating Temperature	bara				
10 Design Capacity (per pump)	m ³ /h				
11 Normal Capacity (per pump)	m ³ /h				
12 Discharge Pressure	barg				
13 Suction Pressure	barg				
14 Differential Head	bar /m				
15 Minimum NPSH Available/Required	m				
16 Hydraulic Power (per pump)	kW				
17 RPM					
18 Estimated Pump Efficiency	%				
19 Estimated Shaft Power (per pump)	kW				
20 Type of Driver					
21 Driver Rated Power (per pump)	kW				
22 Design Power Consumption (per pump)	kW				
23 Normal Power Consumption (per pump)	kW				
24 Max. Shut-Off Head	bar				
25					
26 Material: Casing					
27 Impeller					
28 Shaft					
29 Sour Service					
30 Packing Type/Mechanical Seal Type					
31					
32 Services/Utilities					
33 Cooling Water					
34 Seal/Flush Fluid	m ³ /h				
35 Quench	m ³ /h				
36 Notes					
37					
38					
39					
40					
41					
42					
43					
44					
45					


Issue No.:
Description
Made/Revised by
Checked by
Approved Process
Approved

Sheet of


		RELIEF DEVICE PHILOSOPHY SHEET			DOCUMENT/ITEM REFERENCE				
		EQUIPMENT No.:							
		DATE:			SHEET No.:		OF		
CHECKED BY:		MADE BY:						1	
								2	
DESIGN CODES:		VESSELS	EXCHANGERS	LINES			3		
								4	
OTHER REQUIREMENTS								5	
								6	
BASIS FOR CALCULATION:								7	
								8	
SET PRESSURE, psig:		MAX. BACK PRESSURE:		(a) BEFORE RELIEVING		(b) WHILE RELIEVING		9	
NORMAL CONDITIONS UNDER RELIEF DEVICE:						Calculated		10	
STATE:		TEMPERATURE, °F:		PRESSURE, psig:				11	
								12	
HAZARDS CONSIDERED				POSSIBLE CAUSE?		FLUID RELIEVED		RELIEF RATE, lb/h	ORIFICE AREA, in. ²
1. Outlets blocked									
2. Control Valve malfunction									
3. Machine trip/overspeed/density change									
4. Exchanger tube rupture									
5. Power failure/Voltage dip									
6. Instrument air failure									
7. Cooling failure									
8. Reflux failure									
9. Abnormal entry of volatile liquid									
10. Loss of liquid level									
11. Abnormal chemical reaction									
12. Boxed in thermal expansion									
13. External fire									
14. (specify)									
15. (specify)									
16. (specify)									
SELECTED DESIGN CASE:								30	
								31	
RELIEVED FLUID: STATE		DENSITY/MW:		TEMPERATURE		C _p /C _v :		32	
COMPOSITION:								FLASHING	
RELIEF RATE REQUIRED, lb/h:		ORIFICE SELECTED:		AREA, in. ² :		TYPE:		34	
ACTUAL CAPACITY, lb/h								35	
REMARKS/SKETCH								36	
								37	
								38	
								39	
								40	
								41	
								42	
								43	
Issue No:	1	Date	2	Date	3	Date	44		
Description							45		
Made/Revised by							46		
Checked by							47		
Approved Process							48		
Approved							49		


		TANK AND VESSEL AGITATOR DATA SHEET		Drawing No:
		Project Name:		Project No.:
		Equipment No:	No. Off:	sheet Of
		Associated Vessel/Tank* Item No:		
Date		1. Largest and smallest charge:		
		2. Components added during mixing:		
3		3. Agitator operating while vessel is being filled or product withdrawn? Yes/No*		
		4. If continuous, throughput per hour:		
Date		5. Process duty: Mixing liquids/Dissolving/Suspensions/Emulsions/Gas absorption/Homogenisation*		
		6. Mixing effect: Violent/Medium/Moderate*		Time available for mixing:
2		7. Working Pressure:		Design Pressure:
		8. Working Temperature:		Design Temperature:
Date		9. Special Remarks:		
1		10. Components % by weight:		
		11. Temperature during mixing:		
		12. Specific gravity of components:		
		13. Viscosity of mixing at mixing temperature:		
		14. Specific gravity of product at mixing temperature:		
		15. Size of solid particles:		
		16. Special Remarks:		
Description		17. Type of impeller:		
Made/Revised by		18. Number of impellers on shaft:		
Checked by		19. Position of impellers:		
Approved Process		20. Distance between shaft end & vessel:		Bottom bearing:
Approved		21. Preferred impeller speed:		Shaft diameter:
		22. Type of drive: Direct/Vee belt/Fluid*		
		23. Type of seal: Vapor/Packed gland/Mechanical/Easy replacement*		
		24. Method of installation: Assembled in/Assembled out* of vessel		
		25. Entry position:		
		26. Materials of construction:		
		27. Absorbed HP/KW*:		Installed HP/KW*:
		28. Other information:		
		29. Dimensions:		Capacity:
		30. Coils, baffles, etc.:		
		31. Fixing agitator (beams, flanges, etc.):		
		32. If at atmospheric pressure: Closed/Open*		Can stuffing box be greased? Yes/No*
		33. Headroom available above agitator:		
		34. Other information:		
		35. Agitator installed: Indoors/Outdoors		Motor enclosure:
		36. Electrical specification:		
		37. Any other electrical information:		
		38. Motor to be included: Yes/No*		
		39. Motor Will/Will not* be sent to manufacturer for assembly and alignment.		
		40. Threads: Unified /*		
		41. All rotating parts must be strictly guarded to BS 1649/ASME		
		42. Fixing bolts supplied by:		
		43. Net weight including motor:		
		44. Witnessed run in air:		
		45. General notes:		


NOTE: * Indicates delete as necessary.

		TANK PROCESS DATA SHEET				Doc. No: Item No. Sheet of	
		Job:					
Item Name:							
NOTE: * Indicates delete as necessary; ** Indicates for other than Code reason							
5							
10							
15							
20							
25							
26	Shell Diameter (OD/ID):		Shell Length:			No. Required:	
27	Centre Line*: Horizontal/Vertical						
28	Pressure: g	Temperature: °F/°C	Nozzles	Mark No.	Size	Number	
29	Item Number		Inlet	C-			
30	Operating						
31	Design		Vapor Out	C-			
32	Emergency Vacuum Design*: Yes/No						
33	Material	Corr. Allowance	Liquid Out:	C-			
34	Shell						
35	Heads						
36	Liner		Thermocouple	R-	by Inst. Op.		
37	Type of Heads		Pressure Gauge	R-			
38	Code:		Gauge Glass	R-			
39	Stress Relieve**:	Radiography**:	Level Control	R-			
40	Joint Efficiency:		Safety Valve	R-			
41	Density of Contents:	at	*° F/° C				
42	Weight Empty:	Weight Full:					
43	Is vessel subject to mechanical vibration? *Yes/No			Vent	C-		
44	Insulation:	Type: *Frost and Personnel Protection/Cold	Drain	C-			
45	*Yes/No	/Anticondensation/Heat Conservation	Steam Out	C-			
46	REMARKS:						
47			Manhole	A-			
48							
49							
50							
51							
52			Min. Base Elev'n:		k- Skirt Length		
53			Material:				

Issue No.	1	Date	2	Date	3	Date	4	Date
Made/Revised by								
Checked by								
Approved Process								
Approved by								

Made by: Date: Checked by:		TOWER PROCESS DATA SHEET	Document No. Job Item No.(s) Item Name Sheet of				
Tower Name:							
NOTE: * indicates delete as necessary; ** indicates for other than code reason							
1		Top	Bottom				
2	Shell Diameters OD - ID						
3	No. of Trays						
4	Pressure	Operating					
5	* psig	Design					
6	Temperature	Operating					
7	* ° F/° C	Design					
8	Material	Shell					
9		Trays					
10		Caps					
11		Liner or Clad					
12	Corrosion -	Shell					
13	Allowance	Heads					
14		Trays					
15	Tray Spacing						
16	Type of Liquid Flow						
17	Type of Trays						
18	Joint Efficiency						
19	Code	Emergency Vac. Design *Yes/No					
20	Stress Relieved **Yes/No	Radiography **Yes/No					
21	Is vessel subject to mechanical vibration *Yes/No						
22	Insulation	Type: *Frost and Personnel Protection/Cold/					
23	*Yes/No	/anticondensation/Heat Conservation					
24	Min. Base Elevation:	Skirt length:					
25	Weight Empty:	Full:					
26	Nozzles	Mark No.	Size	Number			
27	Feed	C-					
28							
29	Overhead Vpr	C-					
30	Reflux In	C-					
31							
32	Bottoms	C-					
33	Reboiler Vpr	C-					
34	Reboiler liq	C-					
35							
36							
37	Thermocouple	R-	by inst. Gp.				
38	Level Glass	R-					
39	Press Gauge	R-					
40	Level Control	R-					
41	Safety Valve	R-					
42							
43							
44	Vent	C-					
45	Drain	C-					
46	Steam Out	C-					
47	Manholes	A-					
48	Handholes	A-					
49	Cap Type:	Tray Layout Ref:					
50	NOTES						
51							
52							
53							
54							
55							
56	Description	1	Date	2	Date	3	Date
57	Made/Revised by						
58	Checked by						
59	Approved Process						
60	Approved by						

		TRAY LOADING SUMMARY				Job No.	
						Item No.	
		Job:				Sheet of	
Tower Name:		Type of Tray					
1	Manufacturer					Mfr. Ref:	
2	Pressure at top of Tower	barg	psia				
3	Max. ΔP over Tower	bar	psi	Units Used: METRIC/BRITISH (delete one)			
4	No. of Trays	Above Feed			Below Feed		
5	Tray location						
6	Tray Number*						
7	Tray Spacing	mm	in.				
8	Tower Internal Diameter ID	mm	in.				
9	Vapor to Tray						
10	Temperature	°C	°F				
11	Compressibility						
12	Density	kg/m ³	lb/ft ³				
13	Molecular Weight						
14	Rate	kg/h	lb/h				
15							
16	Liquid from Tray						
17	Temperature	°C	°F				
18	Surface Tension	dynes/cm	lb/ft				
19	Viscosity	cP	lb ft/h				
20	Density	kg/m ³	lb/ft ³				
21	Rate	kg/h	lb/h				
22	Foaming Tendency**						
23	Number of Passes						
24	Minimum Hole Diameter***	mm	in.				
25	Minimum DC Residence Time***	s	s				
26	Maximum Rate as % Design						
27	Minimum Rate as % Design						
28	Design Rate % Flood Rate***						
29							
30	Tray Material						
31	Valve or Cap Material						
32	Corrosion Allowance	mm	in.				
33	Tray Thickness***	mm	in.				
34							
35							
36							
37							
38	NOTES:	* Trays are numbered from the bottom of the tower upwardstop of the tower downwards					
39		** Indicate whether "non", "moderate", "high" or "severe"					
40		*** Data to be supplied by tray manufacturer unless special Process/Client requirement entered here.					
41	REMARKS:						
42							
43							
44							
45							
46							
47							
48							
49							
50							
51							
52							
53							
54		1	Date	2	Date	3	Date
55	Description						
56	Made/Revised by						
57	Checked by						
58	Approved Process						
59	Approved by						

	WATER ANALYSIS SHEET	Submitted by: Address:	Location: Date:
	** Analysis	No. Date:	
	pH Value		
	Suspended Solids mg/l		
	Total Dissolved Solids mg/l at 110° C		
	Total Dissolved Solids mg/l at 180° C		
	Alkalinity to Pp as mg/l CaCO ₃		
	Alkalinity to MO as mg/l CaCO ₃		
	Sulphate as mg/l SO ₄		
	Chloride as mg/l Cl		
	Nitrate as mg/l NO ₃		
	Silica as mg/l SiO ₂		
	Phosphate as mg/l PO ₄		
	Total Anions as mg/l CaCO ₃		
	Total Hardness as mg/l CaCO ₃		
	Calcium as mg/l Ca		
	Magnesium as mg/l Mg		
	Sodium* as mg/l Na		
	Potassium* as mg/l K		
	Iron as mg/l Fe		
	Manganese as mg/l Mn		
	Free and Saline Ammonia as mg/l NH ₃		
	Total Cations as mg/l CaCO ₃		
	Free Dissolved CO ₂ as mg/l CO ₂		
	Dissolved O ₂ as mg/l O		
	Colour Hazaeen Units		
	Turbidity Formazin Units [†] FTU APHA		
	Lead as mg/l Pb		
	Copper as mg/l Cu		
	Residual Chlorine		
	Flouride as mg/l F		
	Sulfite as mg/l SO ₃		
NOTES: 1. Please state if units other than milligrams per liter, or different conditions of test, are used. 2. * If Na and/or K form an appreciable amount of total cations, please state Alkalinity to Phenolphthalein (p), Alkalinity to Methyl Orange (MO), and Carbonate Hardness. 3. [†] DO NOT use Formazin Units as defined by British Standard BS. 2690 Pt. 9. 4. ** Tick if item definitely to be included in analysis. 5. 100 mg/L CaCO ₃ = 2 milliequivalents/ (m val/L).			

Index

- Acid gas treatment, 439
Acid strength, 344, 348, 354
Acidity, 36, 41, 45, 194, 222, 251, 263, 316, 356–357, 442
Additives, 3, 18, 27, 132, 279, 291–292, 334, 363, 443, 447–448, 467, 476, 481, 489
Adsorption, 6, 26, 199, 215, 274, 328, 335, 367, 371–376, 378–379, 401, 410, 412
Air pollution, 172, 176, 385, 403, 495, 509
Alkylclean, 343, 349, 351
Alkylate, 116–117, 339–354, 356–358, 442–443, 447, 476, 489
Alkylate gasoline, 342, 356–357
Alkylation processes, 339, 347–348, 353, 356, 482, 492
Aniline point, 39, 43, 59–60, 250, 387, 443, 445
API gravity, 22, 32–34, 36, 38, 42, 51, 53, 57, 59, 89, 99, 134, 154, 166, 172
ARDS, 253–257, 260, 299, 522
Aromatization, 218, 237, 314, 321–322
ASTM distillation, 48–49, 56–57, 59, 134–135, 250, 445, 458–459, 463, 469
ATK, 217, 219–220, 248, 250
Atmospheric distillation, 114, 120, 133, 138, 150, 152, 445, 447, 479, 486–487
Aviation, 27, 57, 59, 116, 121, 131–132, 217, 219, 250, 339, 348, 351
Aviation turbine kerosene, 217, 219, 250
- Barrels per calendar day, 4, 447
Benzene, 5–6, 14–17, 23, 27, 39, 43, 60, 79, 94, 97–98, 114, 117–118, 121, 131, 133, 162, 177, 193, 201–202, 215, 247–248, 284, 302, 306, 308–310, 314, 318–324, 328–329, 331–339
Blending, 3, 37, 57, 60, 112, 114, 116–121, 170, 174, 179, 196
Blending octane number, 351, 448–449
Boiling range, 12–13, 25–26, 53, 61–62, 65, 106, 114–115, 126, 131–133, 137, 150, 152, 183, 192, 196, 240, 255, 272, 396, 449, 453, 464, 476, 479, 485–486, 489–490, 511, 521, 529
Boiling temperature, 59, 96, 152, 449, 481, 527
Branched paraffins, 339, 348
Bright stock, 112, 114, 450
Bunker fuel, 451, 529
Butane, 9–10, 12, 24, 26–27, 29, 38, 42, 58, 71, 94, 97, 114, 116
Butylenes, 116, 266, 295, 344, 346–349, 351, 358, 442, 453, 487, 499, 519
- Carbon residue, 22, 34, 37, 161, 163, 169, 173, 234–235, 287, 300, 445, 452, 456
Carbonate, 7, 368, 370, 389–390, 402–403, 442, 622
Catalyst/oil ratio, 452
Catalytic cracked gasoline, 296
Catalytic cracking, 4, 22, 28, 34, 112–115, 117, 120, 122, 148, 165, 187–188, 191, 195, 199, 221, 227, 259–269
Catalytic hydrocracking, 452
Catalytic hydrotreating, 18, 191, 239, 261, 462
Catalytic reforming, 3, 7–338, 365, 448, 523
Cetane, 10, 13, 27–28, 35, 37, 39, 43, 58–59, 65, 132, 237, 382, 384–385, 453–454, 462, 481
Chemical release and Flash fire, 358
Chemical solvent, 393
Chemistry of Alkylation, 340
Classifications, 187
Claus process, 396, 399–400, 493
Clean Fuels, 1, 306, 379
Coke removal, 158, 276
Coker gas oil, 117, 158–161, 168–170, 172, 218, 244, 285–286, 454, 478, 486
Coker naphthas, 307
Conradson carbon, 161, 163, 166, 169, 260, 287, 300, 382, 384–385, 445, 452, 456
Crude assay, 37, 133–134, 445, 458–459, 484
Crude distillation, 12, 36, 63, 116–117, 120–123, 127, 129–133, 137, 139–142, 150, 152, 181, 238, 308–309, 346, 395, 447, 518, 523
Cycle stock, 279, 287–288, 452, 459
Cyclization, 196, 272–275, 305–306, 313–314, 322–323, 459
Cyclohexane, 13–15, 19, 21, 94, 190, 247–248, 274, 284, 302, 318–321, 323, 385, 523, 560
Cycloparaffins, 13–15, 274
Cyclopentanes, 13, 321, 328

- DAO, 189, 238, 385, 460
 DEA, 389–391, 407–409, 562
 Deasphalting, 24, 132, 238, 460
 Decalin, 13–14, 242
 Decoking, 158–159, 169, 172–173, 176, 299, 461
 Dehydrocyclization, 314–315, 319–321, 323, 326
 Dehydrogenation, 6, 8, 180, 196, 266, 273–275, 284, 305, 308, 346, 451, 461
 Delayed coker, 158–159, 161, 163–164, 172–173, 177, 180, 186, 461
 Delayed coking, 117, 149, 157–161, 163–164, 169, 177, 180, 186, 270, 284, 455, 461
 Desalting, 3, 120–125, 461
 Desulfurization, 196–197, 200, 222–223, 226, 234–237, 250, 252–256, 261, 366–367, 453, 462, 502, 573–574
 Dewatering, 120, 176
 Dewaxing, 3, 112–113, 188, 194, 196, 462, 493, 516
 DGA, 389–391, 407–408
 Diesel fuels, 28, 37, 112, 132, 292, 385, 451, 453, 463
 Diethanolamine, 389–390, 404, 435, 562
 Diglycolamine, 404
 Diolefins, 234, 242, 273, 383–384, 450, 454, 506
 Direct oxidation, 389, 392, 399
 Distillation curves, 50–52, 56, 134, 300, 464, 501
 Dry gas, 29, 116, 221, 262–263, 277, 281, 405, 411, 464, 475

 Emission, 118–119, 290–292, 304, 375, 381–382, 443, 453, 469, 481
 Emissions standards, 2, 306
 ETBE, 340, 467, 495
 Ethane, 6, 9–10, 12, 19, 26, 29, 38, 42, 69, 71, 74, 94, 97, 114, 118, 130, 133–134, 214, 266, 311, 330, 336–337, 366, 535, 562, 600
 Ethanol, 1, 79, 340, 442, 465, 467, 469, 489, 495, 563
 Ethers, 20, 261, 340, 447, 476, 489, 495
 Ethyl tertiary butyl ether, 467, 495
 Ethylbenzene, 6, 17, 94, 190–191, 242, 335–337, 342
 Explosive limit, 487, 525, 558–560, 563, 565, 567–569

 FCC, 2, 4–6, 21, 60, 139, 157–158, 188, 237–238, 259–263, 265–271, 273–274, 391, 395, 461–462, 474, 478–479, 516, 520, 522
 Flash drum, 514
 Flash point, 27, 37, 56–58, 131, 133, 144, 181, 231, 250–251, 300–301, 387, 470–471, 490, 592
 Flexicoking, 167, 471, 523
 Flue gas, 169, 262–265, 278, 280, 283–284, 290–292, 295–298, 300–301, 303, 367, 397, 474
 Fluid coking, 149–150, 157, 164–165, 169, 186, 455, 474, 523
 Fluidized bed, 150, 206, 259, 262–264, 279, 293, 296, 470, 474
 Fluidized bed catalytic cracking, 262
 Freezing point, 90, 251, 390, 451
 Furnace cracking, 181

 Gas oil fraction, 260
 Gas oils, 27–28, 46, 61, 114, 132, 134, 141, 152, 190, 221, 223, 235, 240, 262, 284, 479, 486, 525
 Gas purification, 368, 399, 410
 Gasification, 5, 165, 174–175, 371
 Gasoline, 5–6, 9, 12, 14, 18, 24–27, 29, 32–33, 37, 46, 57–59, 110–121, 131–133, 150, 158–159, 161

 Hazards, 146, 175, 186, 258, 342–343, 354, 361–362, 446, 456–457, 469, 531, 610
 Hempel distillation, 479
 Hydroconversion, 187–188, 384, 438
 Hydrocracking, 5, 116–117, 120, 187–188, 190–191, 193–203, 214–215, 217–229, 231–234, 236, 284–285, 306, 365, 384, 452, 462, 476, 479–480, 521
 Hydrodealkylation, 117–118, 188, 193, 197, 201, 226, 336–337, 371
 Hydrofluoric acid, 339–340, 342, 344, 347, 349, 354–355, 358, 443, 479
 Hydrogen production, 3, 120, 226–227, 309, 323, 337, 365, 367, 369, 371, 373, 375–377, 379
 Hydrogen recovery, 255, 371–372, 375–376, 379
 Hydrogen sulfide, 9, 18–19, 36, 38, 42, 65, 112, 118, 134, 145, 186, 190, 192, 194, 322, 403, 480, 493, 508, 517, 520, 567
 Hydrogenation, 6, 22, 26, 187, 190–191, 193–194, 196–197, 199, 201–202, 214–215, 295, 315–316, 358, 367, 383–384, 469, 480
 Hydrotreating, 5, 18–19, 117, 165, 187–188, 191, 196–198, 203, 220, 253–255, 453, 462, 480, 493, 508, 523

 Isoamylene, 272, 522
 Isobutane, 10–12, 26, 71, 94, 97, 117, 158, 214, 260, 339–354, 356–358, 361, 363, 442, 461, 508, 511, 600
 Isobutylene, 26, 261, 272, 341, 355, 467, 487–488, 522
 Isomerase, 117, 482
 Isomerization, 3, 5–6, 10, 117, 120, 187, 261, 271–275, 305–307, 309–311, 329–331, 333, 482–484, 490, 492–493
 Isooctane, 11, 262, 339–341, 352–353, 355, 443, 449, 479, 484, 489, 491–492, 495
 Isoparaffins, 11, 201, 221, 272, 320–321, 329, 341–342, 349
 Isopentane, 11–12, 71, 94, 97, 116, 321, 341–342, 349, 443, 482, 484, 490–491, 511, 567, 600

 Jet fuels, 121, 131, 390, 475, 516

 K-factor, 64–66, 72
 Kerosene, 5–6, 9, 25–28, 35, 57, 112, 127, 130–135, 138, 141–142, 144, 146, 148, 153, 158, 179, 187–190, 196, 198, 202, 217, 228–232, 237–238, 240, 309, 508, 516, 520, 525, 530, 568
 Ketones, 20–22, 494
 Kinematic viscosity, 80, 82–85, 91, 250–251, 441, 453, 485, 522

- Light cycle oil, 116, 244, 260, 263, 266, 281, 286, 486
 Light gases, 106, 116, 138, 150, 196, 220, 259, 305, 308, 315, 355, 476, 521, 523
 Light hydrocarbons, 57–58, 66, 75–76, 121, 125, 144, 172, 183, 230, 245, 260, 329, 354, 366, 373, 490
 Light straight run gasoline, 25
 Liquefied petroleum gas, 26, 29, 116, 119, 121, 130–131, 171, 262, 388, 393, 395, 487
 Liquid hour space velocity, 486
 Lubricating oil, 26, 34, 113–115, 133, 150, 190, 214, 442, 520
- M-xylene, 6, 17, 94, 335, 600
 Material and energy balance, 231, 234
 MDEA, 119, 389–391, 393, 435, 442
 MEA, 389–391, 402, 404, 407–408, 444, 562
 Membrane, 367, 372, 378, 410, 489, 528, 565
 Mercaptans, 18–19, 119, 192, 235, 240, 332, 370, 374, 381–383, 391–393, 395, 476, 488, 517, 520
 MEROX, 119, 266, 382, 390–392, 394–396, 438
 Metals content, 384
 Methanation, 198, 200, 366, 368, 371, 375
 Methanol, 6, 79, 121, 174, 199, 261, 372, 402, 410, 442, 498, 522, 568, 600
 Methyl diethanolamine, 435
 Methyl tertiary butyl ether, 261, 340, 488–489, 495, 573, 575 Modified Claus process, 399
 Molecular sieves, 366, 373, 410, 476
 MON, 36, 39, 43, 120, 262, 266, 276, 281, 300–301, 341, 357, 368, 491–492
 Motor octane number, 11, 262, 443, 489, 491–492, 511, 513
 MTBE, 6, 261, 272, 293, 305, 340, 348, 354, 488–489, 495, 507, 600
- N-butane, 10, 12, 38, 42, 71, 94, 97, 116–117, 130, 134, 260, 276, 302, 322, 343, 346, 350, 358, 424–425, 511, 538
 N-octane, 11, 71, 94, 484, 492, 569
 N-pentane, 12, 25, 38, 42, 66, 68, 71, 78, 80, 94, 97, 134, 242, 321, 425, 461, 492, 511
 Naphtha, 5–6, 25–26, 33, 35, 53–54, 57, 59–60, 111–112, 114, 116–123, 127, 157–161, 188–191, 194–196, 240, 245–248, 322–324, 367, 372, 448, 489–490, 493, 496, 506, 508
 Naphthenes, 8–9, 13–15, 33, 35, 38–40, 42–44, 55, 60, 90–91, 93, 96, 188, 190, 192, 201, 262, 492, 499, 511, 529
 Naphthenic, 8, 15, 17, 21, 23, 34–35, 60–61, 91, 158, 183, 218, 242, 263, 284–285, 307, 458, 490, 529, 531
 Natural gas, 1, 6–7, 26, 29, 101, 108, 112, 118, 121, 133, 224, 367–368, 370, 381, 388–390, 393, 396, 402, 405–406, 410, 413, 415, 438–439, 441–443, 445, 449, 451, 488, 490–491, 494, 530, 574, 607
 New Technology of Alkylation, 356
 Nitrogen, 8–9, 16, 18, 22–24, 29, 32, 36–37, 39, 43, 65, 72, 74, 105, 145, 152, 154, 161, 187–188, 190, 228, 234–237, 240, 287, 370, 373–374, 382–385, 387–388, 419, 534, 600
 Nitrogen content, 22–23, 36, 194, 196, 243, 445, 451
 Normal paraffins, 10–11, 61, 202, 272, 321,
- Octane, 4, 10–12, 14, 27, 31, 33, 58, 71, 94, 111–112, 114, 120, 183, 194, 221, 245, 295, 305–309, 311, 313–315, 318–319, 321, 323, 476, 479–480, 499, 508, 510–511, 531, 542, 569
 Octane number, 11, 27, 58, 183, 194, 261–263, 266, 305–306, 313–315, 319, 329, 332, 344, 348, 351, 443, 458, 479–480, 484, 510–511, 513–514, 519
 Oil fraction, 34, 145, 260, 445, 479, 524
 Olefin, 6, 11–12, 96, 163, 190, 196, 202, 237, 241–242, 266, 270–276, 296, 363, 383, 442, 451, 503
 Oxidation, 6, 19, 23, 119, 166, 174, 199, 368, 371, 382, 389, 391–393, 395, 486, 489, 494, 520
- P-xylene, 79, 94
 Paraffinic, 8, 10, 13, 23, 33–36, 60–61, 91, 108, 143, 284, 286, 313–314, 334, 453–454, 458
 Paraffinic hydrocarbons, 60, 339
 Paraffins, 6, 8–14, 28–29, 32, 35–36, 38–45, 55, 60–61, 90–91, 93, 96–98, 180, 192, 194, 201–202, 262, 272–274, 319–324, 443, 492, 495, 499, 530
 Petroleum coke, 29, 114, 117, 152, 159–160, 165, 174–175, 461, 496, 508, 529
 Phenol, 6, 20–21, 146, 186, 192, 235, 299, 392, 569
 Phosphoric acid, 352, 355
 Physical solvent, 389, 401–402, 496
 Polymerization, 3, 26, 112, 116, 120, 170, 180, 193, 238, 272–273, 275, 339, 341–349, 361, 363, 384, 442, 448, 453, 499
 Pour point, 27, 36–37, 39, 41, 43, 45, 55, 132, 179–180, 183, 230, 250, 387, 445, 458, 499
 Process description, 120, 138, 152, 220, 237, 262, 348–349, 355, 372, 384–385, 392–393, 395, 398–400, 404–405
 Pump around reflux, 126–127
- Refineries, 2, 4, 25, 36–37, 120, 126, 131, 145, 150, 174, 179, 181, 264, 284, 329, 379, 381, 383, 499, 503, 508, 519, 521, 525
 Refinery distillation, 464, 475, 495
 Reforming, 3, 5–6, 18, 29, 37, 57, 112–113, 115, 117, 120–121, 131, 133, 158, 199–200, 245, 296, 305–323, 382, 388, 448, 452–453, 456, 480, 489, 508–509, 519, 521, 523, 531
 Reforming processes, 305, 308, 311, 316–317, 328
 Refractive index, 35, 87–91, 98, 284, 287
 Regenerators, 266, 283, 311, 323, 436
 Reid vapor pressure, 37, 57–58, 445, 476, 509–510, 528
 Research Octane number, 313, 319, 329, 332, 443, 491, 510, 514
 Residuum, 132, 154, 180–181, 188, 214, 234, 260, 384, 444, 447, 511, 525, 527

- RON, 39, 43, 262, 266, 281, 300–301, 307, 317–319, 321, 329–330, 443–444, 491–492, 510
- Safety, 2, 5–6, 131, 145, 175–176, 185, 258, 292, 298–299, 340, 343, 354, 356, 361, 363, 478, 481–482, 488, 494, 498–499, 530–531, 585, 606, 608, 612, 615
- Salt content, 36–37, 41, 45, 122, 125, 445, 513
- Saturated paraffins, 11, 248
- Saturates, 9, 22, 215, 285, 300, 385, 491
- SCOT, 117, 119, 382, 398
- Selective hydrocracking, 194, 462
- Selectivity, 136, 188, 196–199, 276, 279, 286, 294–295, 299, 304, 311, 322, 403–404, 453, 513, 517
- Semiregenerative, 311–312, 316, 338
- Shift conversion, 368, 370
- Sinopec, 4
- Sludge, 403, 434, 443
- Smoke point, 35, 39, 43, 57, 201, 250–251, 382, 451, 516
- Solvent dewaxing, 493
- Solvent extraction, 3, 189, 462, 506, 517
- Sour crude, 18, 36, 299, 365, 488, 517, 520
- Sour water, 106, 109, 125, 131, 151, 160, 171, 173, 226, 229–230, 252, 258, 381–382, 393, 435–438
- Sour water stripping, 258, 381–382, 435–438
- Sponge coke, 174–175
- Sponge coke, 174–175
- Sponge oil, 170, 172, 268–269, 517
- Steam cracking, 120, 150, 294, 518–519
- Steam reforming, 199–200, 245, 366–367, 371, 375, 493, 519
- Sulfinol, 366, 368–370, 389, 402, 404
- Sulfolane process, 331–332
- Sulfur dioxide, 18–19, 332, 358, 410
- Sulfur recovery, 3, 118–120, 290, 381–382, 388, 390, 393, 396–403, 405, 436
- Sulfuric acid, 121, 339–340, 342, 344–348, 350, 353–356, 392, 442, 477, 520
- Sweet crude, 36, 450, 520
- Sweetening, 3, 5, 18, 112, 119, 381–382, 405, 410, 438, 476, 520
- Sweetening processes, 389, 392–393
- Tail gas treatment, 3
- TAME, 272, 305, 340, 495, 522
- TAN, 36, 119, 442, 521, 548
- TBP distillation, 46, 49, 52, 55–56, 246, 479, 505
- Tertiary amyl methyl ether, 522
- Thermal process, 177, 518
- Toluene, 5–6, 14, 16–17, 40, 44, 79, 94, 111, 117–118, 121, 193, 201, 309, 372, 374, 444, 450, 453, 476, 489, 492, 523, 570, 600
- Topped crude, 112, 121, 127, 146, 150, 152–154, 523
- Treating process, 220, 393, 403, 480
- True boiling point, 33–34, 46, 48–49, 60, 106, 133–135, 140, 154, 214, 235, 445, 449, 458–459, 475, 477, 516, 524
- True boiling point distillation, 49, 60, 140, 477, 516, 524
- Turbine fuels, 46, 132
- U.S. Bureau of Mines, 60, 284, 457, 479, 524
- Unsaturation, 273, 368, 419 UOP, 5–6, 8, 34–35, 159, 186, 258, 266–267, 299, 305–306, 310–311, 318, 323, 328–332, 340, 349, 351–352, 354–357, 363, 384–385, 411, 438, 454
- Upgrading, 5, 24, 167, 179, 354, 384, 386, 445, 508, 519
- Vacuum distillation, 3, 5, 112–115, 120–121, 132, 138, 150–156, 194, 231, 260–261, 479, 487, 493, 527
- Vacuum reduced crude, 529
- Vapor pressure, 37, 57–58, 65, 72, 74–80, 110, 143, 150, 231, 346, 356–357, 402, 442, 509–510, 608–609
- Visbreaking process, 183–184, 186
- Viscosity index, 221, 529
- Volumetric space velocity, 195
- Watson characterization factor, 445, 458
- Weight hour space velocity, 530 WHSV, 203, 279, 315–316, 318, 328, 330, 517, 530
- Xylenes, 14, 335–336, 374, 444, 447, 476, 489
- Zeolite catalysts, 260