

**RULES OF THUMB**

**FOR**

**PETROLEUM  
ENGINEERS**



**JAMES G. SPEIGHT**

 **Scrivener  
Publishing**

**WILEY**



# Rules of Thumb for Petroleum Engineers

**Scrivener Publishing**

100 Cummings Center, Suite 541J  
Beverly, MA 01915-6106

*Publishers at Scrivener*

Martin Scrivener ([martin@scrivenerpublishing.com](mailto:martin@scrivenerpublishing.com))  
Phillip Carmical ([pcarmical@scrivenerpublishing.com](mailto:pcarmical@scrivenerpublishing.com))

# Rules of Thumb for Petroleum Engineers

James G. Speight



WILEY

This edition first published 2017 by John Wiley & Sons, Inc., 111 River Street, Hoboken, NJ 07030, USA and Scrivener Publishing LLC, 100 Cummings Center, Suite 541J, Beverly, MA 01915, USA  
© 2017 Scrivener Publishing LLC  
For more information about Scrivener publications please visit [www.scrivenerpublishing.com](http://www.scrivenerpublishing.com).

All rights reserved. No part of this publication may be reproduced, stored in a retrieval system, or transmitted, in any form or by any means, electronic, mechanical, photocopying, recording, or otherwise, except as permitted by law. Advice on how to obtain permission to reuse material from this title is available at <http://www.wiley.com/go/permissions>.

#### **Wiley Global Headquarters**

111 River Street, Hoboken, NJ 07030, USA

For details of our global editorial offices, customer services, and more information about Wiley products visit us at [www.wiley.com](http://www.wiley.com).

#### **Limit of Liability/Disclaimer of Warranty**

While the publisher and authors have used their best efforts in preparing this work, they make no representations or warranties with respect to the accuracy or completeness of the contents of this work and specifically disclaim all warranties, including without limitation any implied warranties of merchantability or fitness for a particular purpose. No warranty may be created or extended by sales representatives, written sales materials, or promotional statements for this work. The fact that an organization, website, or product is referred to in this work as a citation and/or potential source of further information does not mean that the publisher and authors endorse the information or services the organization, website, or product may provide or recommendations it may make. This work is sold with the understanding that the publisher is not engaged in rendering professional services. The advice and strategies contained herein may not be suitable for your situation. You should consult with a specialist where appropriate. Neither the publisher nor authors shall be liable for any loss of profit or any other commercial damages, including but not limited to special, incidental, consequential, or other damages. Further, readers should be aware that websites listed in this work may have changed or disappeared between when this work was written and when it is read.

#### ***Library of Congress Cataloging-in-Publication Data***

ISBN 978-1-118-59526-8

Cover image: Kris Hackerott  
Cover design by Kris Hackerott

Set in size of 10pt and Minion Pro by Exeter Premedia Services Private Ltd., Chennai, India

Printed in

10 9 8 7 6 5 4 3 2 1

# Contents

<b>Preface</b>	<b>xix</b>
<b>About the Author</b>	<b>xxi</b>
<b>Abrasion</b>	<b>1</b>
<b>Absorption</b>	<b>3</b>
<b>Acid Gas Removal</b>	<b>5</b>
<b>Acid Gas Scrubbing</b>	<b>9</b>
<b>Acid Number</b>	<b>11</b>
<b>Acid Rain</b>	<b>13</b>
<b>Acid-Base Catalysts</b>	<b>15</b>
<b>Acidity and Alkalinity</b>	<b>17</b>
<b>Acidizing</b>	<b>19</b>
<b>Adsorption</b>	<b>21</b>
<b>Adsorption Isotherm</b>	<b>23</b>
<b>Adulteration</b>	<b>25</b>
<b>Air Emissions</b>	<b>27</b>
<b>Alcohol Blended Fuels</b>	<b>29</b>
<b>Alcohols</b>	<b>31</b>
<b>Alicyclic Hydrocarbons</b>	<b>33</b>
<b>Aliphatic Hydrocarbons</b>	<b>35</b>
<b>Alloys – Composition</b>	<b>37</b>
<b>Amine Absorber</b>	<b>39</b>
<b>Amine Condenser</b>	<b>41</b>
<b>Amine Washing</b>	<b>43</b>

<b>Ammonia</b>	<b>45</b>
<b>Aniline Point</b>	<b>47</b>
<b>Anticline</b>	<b>49</b>
<b>Antoine Equation</b>	<b>51</b>
<b>API Gravity</b>	<b>53</b>
<b>Aromatic Hydrocarbons</b>	<b>59</b>
<b>Asphalt Manufacture</b>	<b>61</b>
<b>Asphaltene Constituents</b>	<b>63</b>
<b>Associated Natural Gas</b>	<b>65</b>
<b>Atmospheric Equivalent Boiling Point</b>	<b>67</b>
<b>Auto-ignition Temperature</b>	<b>69</b>
<b>Barrel</b>	<b>71</b>
<b>Baumé Gravity</b>	<b>73</b>
<b>Benchmark Crude Oil</b>	<b>75</b>
<b>Bernoulli's Principle</b>	<b>77</b>
<b>Biomass and Biofuels</b>	<b>79</b>
<b>Bitumen</b>	<b>83</b>
<b>Bituminous Rock and Bituminous Sand</b>	<b>85</b>
<b>Black Acids</b>	<b>87</b>
<b>Black Oil</b>	<b>89</b>
<b>Blending and Mixing</b>	<b>91</b>
<b>Boiling Point and Boiling Range</b>	<b>95</b>
<b>Brine</b>	<b>97</b>
<b>Bubble Point and Bubble Point Pressure</b>	<b>99</b>
<b>Bureau of Mines Correlation Index</b>	<b>101</b>
<b>Calorific Value</b>	<b>103</b>
<b>Capillary Forces</b>	<b>105</b>



Capillary Number	107
Capillary Pressure	109
Carbon Monoxide and Carbon Dioxide	111
Carbon Number and Possible Isomers	113
Carbonate Reservoir	115
Carbonate Washing and Water Washing	117
Catalyst Pore Diameter	119
Catalytic Materials	121
Catalytic Reforming	123
Cementation Value	125
Cetane Index	127
Characterization Factor	129
Chemical Reaction Rates	131
Chemicals Reactive with Water	133
Chemometrics	135
Clausius Equation and Clausius-Clapeyron Equation	137
Coal – General Properties	139
Coke Yield from Conradson Carbon	141
Common Acronyms	143
Common Names of Selected Chemical Compounds	145
Common Unit Conversions	147
Commonly Used Constants	149
Compressibility	151
Coning	153
Conversion Charts	155
Conversion Factors	157
Correlation Index	163

<b>Corrosion</b>	<b>165</b>
<b>Corrosion – Fuel Ash</b>	<b>167</b>
<b>Corrosion – Naphthenic Acid</b>	<b>169</b>
<b>Cricondenbar</b>	<b>171</b>
<b>Cricodentherm</b>	<b>173</b>
<b>Critical Properties</b>	<b>175</b>
<b>Critical Temperatures of Gases</b>	<b>177</b>
<b>Crude Oil – Assay</b>	<b>179</b>
<b>Crude Oil – Classification</b>	<b>181</b>
<b>Crude Oil – Desalting</b>	<b>183</b>
<b>Crude Oil – Distillation</b>	<b>185</b>
<b>Crude Oil – Fractional Composition</b>	<b>187</b>
<b>Crude Oil – Hydrotreating</b>	<b>189</b>
<b>Crude Oil – Molecular Composition</b>	<b>191</b>
<b>Crude Oil – Primary Recovery</b>	<b>193</b>
<b>Crude Oil – Recovery</b>	<b>195</b>
<b>Crude Oil – Refining</b>	<b>197</b>
<b>Crude Oil – Residua</b>	<b>201</b>
<b>Crude Oil – Sampling and Analysis</b>	<b>203</b>
<b>Crude Oil – Secondary Recovery</b>	<b>205</b>
<b>Crude Oil – Tertiary Recovery</b>	<b>207</b>
<b>Crude Oil from Tight Formations</b>	<b>209</b>
<b>Darcy and Non-Darcy Flow in Porous Media</b>	<b>211</b>
<b>Darcy’s Law</b>	<b>213</b>
<b>Decimal Multipliers for SI Prefixes</b>	<b>215</b>
<b>Decline Curve Evaluation</b>	<b>217</b>
<b>Delivery Point</b>	<b>219</b>

Density, Specific Gravity, and API Gravity	221
Density-Boiling Point Constant	223
Determining Depreciation	225
Dew Point Temperature and Pressure	227
Dielectric Constant	229
Dielectric Loss and Power Factor	231
Diesel Index	233
Dipole Moment	235
Distillation	237
Distillation – Flooding	239
Distillation – Gap-Overlap	241
Drilling Fluid	243
Drilling Fluid Additives	245
E85 Fuel	247
Embrittlement	249
Embrittlement – Hydrogen	251
Emulsion	253
Enhanced Oil Recovery	255
Environmental Regulations	259
Evaporation	261
Expansion and Contraction of Solids	263
Explosive Limits	265
Fire Point	267
Fischer-Tropsch Chemistry	269
Flammability and Flammability Limits	271
Flash Point	273
Flow Through Porous Media	275

<b>Fluid Catalytic Cracking – Chemistry</b>	<b>277</b>
<b>Fluid Flow Fundamentals</b>	<b>279</b>
<b>Fluid Flow Through Permeable Media</b>	<b>281</b>
<b>Fluid Flow</b>	<b>289</b>
<b>Fluid Saturation</b>	<b>291</b>
<b>Foamy Oil</b>	<b>293</b>
<b>Formation Volume Factor</b>	<b>295</b>
<b>Fouling</b>	<b>297</b>
<b>Fracturing Fluids</b>	<b>299</b>
<b>Fuel Oil</b>	<b>303</b>
<b>Functional Groups</b>	<b>305</b>
<b>Fundamental Physical Constants</b>	<b>309</b>
<b>Gas Deviation Factor</b>	<b>311</b>
<b>Gas Formation Volume Factor</b>	<b>313</b>
<b>Gas Laws</b>	<b>315</b>
<b>Gas Processing – Hydrogen Sulfide Conversion</b>	<b>319</b>
<b>Gas Processing – Metal Oxide Processes</b>	<b>321</b>
<b>Gas Processing – Oxamine Processes</b>	<b>323</b>
<b>Gas Processing – Sweetening</b>	<b>325</b>
<b>Gas Processing – Absorption and Adsorption Processes</b>	<b>327</b>
<b>Gas Processing – Acid Gas Removal</b>	<b>329</b>
<b>Gas Processing – Carbonate and Water Washing Processes</b>	<b>331</b>
<b>Gas Processing – Catalytic Oxidation Processes</b>	<b>333</b>
<b>Gas Processing - Fractionation</b>	<b>335</b>
<b>Gas Processing – Gas-Oil Separation</b>	<b>337</b>
<b>Gas Processing – Liquids Removal</b>	<b>339</b>
<b>Gas Processing – Metal Oxide Processes</b>	<b>341</b>

<b>Gas Processing – Methanol-Based Processes</b>	<b>343</b>
<b>Gas Processing – Molecular Sieve Processes</b>	<b>345</b>
<b>Gas Processing – Nitrogen Removal</b>	<b>347</b>
<b>Gas Processing – Physical Solvent Processes</b>	<b>349</b>
<b>Gas Processing – Plant Schematic and Products</b>	<b>351</b>
<b>Gas Processing – Processes and Process Selection</b>	<b>353</b>
<b>Gas Processing – Water Removal</b>	<b>361</b>
<b>Gas Solubility</b>	<b>363</b>
<b>Gas-Condensate Reservoirs</b>	<b>365</b>
<b>Gaseous Fuels</b>	<b>367</b>
<b>Gaseous Hydrocarbons – General Properties</b>	<b>369</b>
<b>Gasification – Chemistry</b>	<b>371</b>
<b>Gasification – Refinery Resids</b>	<b>373</b>
<b>Gas-Liquid Solubility</b>	<b>375</b>
<b>Gas-Oil Ratio</b>	<b>377</b>
<b>Gas-Oil Separation</b>	<b>379</b>
<b>Gasoline – Component Streams</b>	<b>381</b>
<b>Gas-to-Liquids</b>	<b>383</b>
<b>Geological Time Scale</b>	<b>385</b>
<b>Geothermal Gradient</b>	<b>387</b>
<b>Glycol</b>	<b>389</b>
<b>Grease</b>	<b>391</b>
<b>Greek Alphabet</b>	<b>393</b>
<b>Hazardous Chemicals</b>	<b>395</b>
<b>Hazardous Waste</b>	<b>399</b>
<b>Heat Capacity</b>	<b>401</b>
<b>Heat Content of Petroleum Products</b>	<b>403</b>

<b>Heat Exchangers</b>	<b>405</b>
<b>Heat of Combustion of Petroleum Fuels</b>	<b>407</b>
<b>Heat of Combustion of Petroleum Fuels</b>	<b>409</b>
<b>Heat Transfer Coefficient</b>	<b>411</b>
<b>Heat Transfer – Convection and Conduction</b>	<b>413</b>
<b>Heating Value</b>	<b>415</b>
<b>Heavy Feedstock Conversion – Thermal Processes</b>	<b>417</b>
<b>Heterogeneity</b>	<b>419</b>
<b>Heterogeneous Catalysis and Homogeneous Catalysis</b>	<b>421</b>
<b>High-Acid Crudes</b>	<b>423</b>
<b>Hydrate Formation and Prevention</b>	<b>425</b>
<b>Hydraulic Fracturing</b>	<b>427</b>
<b>Hydrocarbon Gases – Physical Constants</b>	<b>429</b>
<b>Hydroconversion</b>	<b>431</b>
<b>Hydrogen Chloride</b>	<b>433</b>
<b>Hydrogen in Refineries</b>	<b>435</b>
<b>Hydrogen Sulfide Conversion</b>	<b>437</b>
<b>Hydrogen Sulfide</b>	<b>439</b>
<b>Hydrogen</b>	<b>441</b>
<b>Hydrostatic Pressure</b>	<b>443</b>
<b>Ideal Gas</b>	<b>445</b>
<b>Improved Oil Recovery Processes</b>	<b>447</b>
<b>Incompatible Chemicals</b>	<b>449</b>
<b>Ionic Liquids</b>	<b>451</b>
<b>Isothermal Compressibility of Oil</b>	<b>453</b>
<b>Kinematic Viscosity</b>	<b>455</b>
<b>Liquefied Petroleum Gas</b>	<b>457</b>

<b>Liquid-Gas Separators</b>	<b>459</b>
<b>Lubricants – Classification</b>	<b>461</b>
<b>Lubricating Oil – Base Stock</b>	<b>463</b>
<b>M85</b>	<b>465</b>
<b>Marx-Langenheim Model</b>	<b>467</b>
<b>Material Balance</b>	<b>469</b>
<b>Mean Density – Gas-Air Mixture</b>	<b>471</b>
<b>Mean Density – Gas-Air Mixture</b>	<b>473</b>
<b>Metals Content and FCC Coke Production</b>	<b>475</b>
<b>Methane</b>	<b>477</b>
<b>Molecular Weight of Petroleum Fractions</b>	<b>479</b>
<b>Naphthenic Acids – Corrosion in Distillation Units</b>	<b>481</b>
<b>Naphthenic Acids – Mitigating Corrosion</b>	<b>483</b>
<b>Naphthenic Acids</b>	<b>485</b>
<b>Natural Gas - Associated</b>	<b>487</b>
<b>Natural Gas – Composition</b>	<b>489</b>
<b>Natural Gas – Compressibility</b>	<b>493</b>
<b>Natural Gas – Measurement</b>	<b>495</b>
<b>Natural Gas – Nonassociated</b>	<b>497</b>
<b>Natural Gas – Properties</b>	<b>499</b>
<b>Natural Gas – Specific Gravity</b>	<b>505</b>
<b>Natural Gas – Phase Behavior</b>	<b>507</b>
<b>Natural Gas – Sweetening</b>	<b>509</b>
<b>Natural Gasoline</b>	<b>511</b>
<b>Nitrogen and Nitrogen Oxide Gases</b>	<b>513</b>
<b>Nonassociated Natural Gas</b>	<b>515</b>
<b>Octane Barrel Yield</b>	<b>517</b>

<b>Octane Number</b>	<b>519</b>
<b>Oil and Gas from Tight Formations</b>	<b>521</b>
<b>Oil and Gas Originally in Place</b>	<b>523</b>
<b>Oil Recovery Factor</b>	<b>525</b>
<b>Oil Shale – General Classification</b>	<b>527</b>
<b>Oilfield Chemicals</b>	<b>529</b>
<b>Olamine Processes</b>	<b>531</b>
<b>Olamine</b>	<b>533</b>
<b>On-Stream Factor</b>	<b>535</b>
<b>Opportunity Crudes</b>	<b>537</b>
<b>Organic Compounds – Physical and Thermochemical Data</b>	<b>539</b>
<b>Organic Solvents</b>	<b>547</b>
<b>Oxygen</b>	<b>549</b>
<b>Ozone</b>	<b>551</b>
<b>Paraffin Hydrocarbons</b>	<b>553</b>
<b>Particle Size Classification</b>	<b>555</b>
<b>Permeability</b>	<b>557</b>
<b>Petrochemicals</b>	<b>559</b>
<b>Petroleum Products – Heat Content</b>	<b>561</b>
<b>Petroleum Products</b>	<b>563</b>
<b>Phase Behavior</b>	<b>567</b>
<b>Polychlorobiphenyls</b>	<b>569</b>
<b>Porosity</b>	<b>573</b>
<b>Prefixes</b>	<b>575</b>
<b>Pressure Conversion</b>	<b>577</b>
<b>Principal Component Analysis</b>	<b>579</b>
<b>Process System</b>	<b>581</b>



<b>Product Blending</b>	<b>583</b>
<b>Production Engineering Units</b>	<b>585</b>
<b>Productivity Index</b>	<b>587</b>
<b>Proppants</b>	<b>589</b>
<b>PVT Properties</b>	<b>591</b>
<b>Rate of Reaction</b>	<b>593</b>
<b>Reactor Types</b>	<b>595</b>
<b>Recovery Methods</b>	<b>597</b>
<b>Refinery Feedstocks – Corrosive Constituents</b>	<b>599</b>
<b>Refinery Gas</b>	<b>601</b>
<b>Refinery Types</b>	<b>603</b>
<b>Refinery Units – Materials of Construction and Operating Conditions</b>	<b>605</b>
<b>Refractive Index and Specific Refraction</b>	<b>607</b>
<b>Relative Density</b>	<b>609</b>
<b>Relative Permeability</b>	<b>611</b>
<b>Relative Volatility</b>	<b>613</b>
<b>Reserves – Estimation</b>	<b>615</b>
<b>Reserves</b>	<b>617</b>
<b>Reservoir Crude Oil</b>	<b>619</b>
<b>Reservoir – Drive Mechanisms</b>	<b>621</b>
<b>Reservoir Pressure</b>	<b>623</b>
<b>Reservoir – Types and Classification</b>	<b>625</b>
<b>Reservoir</b>	<b>627</b>
<b>Resid Upgrading Technologies</b>	<b>629</b>
<b>Resource Estimation</b>	<b>631</b>
<b>Retrograde Condensate Systems</b>	<b>633</b>

<b>Retrograde Condensation</b>	<b>635</b>
<b>Reynolds Number</b>	<b>637</b>
<b>Rock Types</b>	<b>639</b>
<b>SARA Analysis</b>	<b>641</b>
<b>Saturated Steam</b>	<b>643</b>
<b>Saturation</b>	<b>645</b>
<b>Sediments, Reservoirs, and Deposits</b>	<b>647</b>
<b>Separators – Gas-Oil Separation</b>	<b>649</b>
<b>Shale Gas Formation</b>	<b>651</b>
<b>Shale Gas Reservoirs – Variation in Shale Properties</b>	<b>653</b>
<b>Shale Gas – Variations in Composition</b>	<b>655</b>
<b>Shale Oil (Kerogen-Derived Oil) – Variation in Properties</b>	<b>657</b>
<b>Shale Plays – Properties</b>	<b>659</b>
<b>SI – International System of Units</b>	<b>661</b>
<b>Solubility Parameter</b>	<b>667</b>
<b>Solvents</b>	<b>669</b>
<b>Specific Gravity</b>	<b>673</b>
<b>Specific Heat</b>	<b>675</b>
<b>Stress-Corrosion Cracking</b>	<b>677</b>
<b>Sulfur Dioxide</b>	<b>679</b>
<b>Sulfur Material Balance</b>	<b>681</b>
<b>Supercritical Fluids</b>	<b>683</b>
<b>Surface Tension</b>	<b>685</b>
<b>Sweetening Processes</b>	<b>687</b>
<b>Synthesis Gas</b>	<b>689</b>
<b>Tar Sand</b>	<b>691</b>
<b>Test Methods</b>	<b>695</b>

<b>Thermal Conductivity</b>	<b>697</b>
<b>Thermal Cracking Processes</b>	<b>699</b>
<b>Tight Formations</b>	<b>701</b>
<b>Unit Process</b>	<b>703</b>
<b>Vapor Density</b>	<b>705</b>
<b>Vapor Pressure</b>	<b>707</b>
<b>Viscosity</b>	<b>709</b>
<b>Viscosity Index</b>	<b>713</b>
<b>Viscosity of Petroleum Fractions</b>	<b>715</b>
<b>Viscosity-Gravity Constant</b>	<b>717</b>
<b>Volume Flow Rate</b>	<b>719</b>
<b>Volumetric Evaluation</b>	<b>721</b>
<b>Volumetric Factors</b>	<b>723</b>
<b>Water – Boiling Point Variation with Pressure</b>	<b>725</b>
<b>Water –Common Impurities</b>	<b>727</b>
<b>Water – Density and Viscosity in Relation to Temperature</b>	<b>729</b>
<b>Water Saturation</b>	<b>731</b>
<b>Watson Characterization Factor</b>	<b>733</b>
<b>Weights and Measures – Density</b>	<b>735</b>
<b>Weights and Measures – Fuels</b>	<b>737</b>
<b>Weights and Measures - General</b>	<b>739</b>
<b>Well Casing</b>	<b>741</b>
<b>Wellbore Stability Analysis</b>	<b>743</b>
<b>Wettability</b>	<b>745</b>
<b>Wobbe Index</b>	<b>747</b>
<b>Working Gas</b>	<b>749</b>
<b>Bibliography and Information Sources</b>	<b>751</b>



## Preface

As worldwide crude oil and natural gas exploration, production, and refining activities increase, there is a continued need for petroleum engineers and natural gas engineers to be aware of the various aspects of the technologies and processes involved within their function to support crude oil and natural gas operations. A competent understanding of technology and various processes that drive the production and refining of crude oil and natural gas is essential.

Another reason for the book is based on observations of young professionals and graduate students as they prepare to enter the fields of natural gas and crude oil development. While many organizations may offer various versions of software to solve engineering problems, many young engineers and students need to hone their fundamental abilities to tackle problems without using a computer. This book, in addition to addressing a variety of engineering issues related to crude oil and natural gas, also provides explanations and equations relating to fundamental chemical, chemical engineering, and petroleum engineering problems. Thus, the book is a compilation of definitions, descriptions, tables,

chemical equations, and formulas of use to petroleum engineers.

To this end, the book has been compiled using a variety of information sources that also reflect the major changes that have occurred in the crude oil and natural gas industries over the past 10 to 15 years. Thus the book offers information relevant to the various sectors of the crude oil and natural gas industries and takes advantage of recent publications related to crude oil and natural gas operations. The contents are arranged alphabetically to provide ready access through an all-inclusive index to recover the desired information.

It is the purpose of this book to provide a ready-at-hand reference book for the office, laboratory, or field that the engineer can consult to help him or her in this task. The book will be a valuable asset for petroleum engineers, experts, and practicing professionals working in the crude oil and natural gas industries.

Dr. James Speight,  
Laramie, Wyoming.  
October 2016.



## About the Author

### DR. JAMES G. SPEIGHT

Dr. James G. Speight CChem., FRSC, FCIC, FACS, earned his B.Sc. and PhD degrees from the University of Manchester, England – he also holds a DSC in The Geological Sciences (VINIGRI, St. Petersburg, Russia) and a PhD in Petroleum Engineering, Dubna International University, Moscow, Russia). Dr. Speight is the author of more than 70 books in petroleum science, petroleum engineering, and environmental sciences. Formerly the CEO of the Western Research Institute (now an independent consultant), he has served as Adjunct Professor in the Department of Chemical and Fuels Engineering at the University of Utah and in the Departments of Chemistry and Chemical and Petroleum Engineering at the University of Wyoming. In addition, he has also been a Visiting Professor in Chemical Engineering at the following universities: University of Missouri-Columbia, Technical University of Denmark, and University of Trinidad and Tobago.

In 1995, Dr. Speight was awarded the Diploma of Honor (Pi Epsilon Tau), National Petroleum Engineering Society, for Outstanding Contributions to the Petroleum Industry. In 1996, he was elected to the Russian Academy of Sciences and awarded the Gold Medal of Honor that same year for outstanding contributions to the field of petroleum sciences. In 2001, the Russian Academy of Sciences also awarded Dr. Speight the Einstein Medal for outstanding contributions and service in the field of Geological Sciences and in 2005 he received the Scientists without Borders Medal of Honor of the Russian Academy of Sciences. In 2006, he was appointed as the Methanex Distinguished Professor, University of Trinidad and Tobago as well as awarded the Gold Medal – Giants of Science and Engineering, Russian Academy of Sciences, in recognition of Continued Excellence in Science and Engineering.





# Abrasion

*Abrasion* is the result of wear caused by friction and *abrasiveness* is the property of a substance that causes surface wear by friction and is also the quality of being able to scratch or abrade another material. Abrasion is the process by which an item or piece of equipment is worn down and can have an undesirable effect of exposure to normal use or exposure to the elements. On the other hand, abrasion can be intentionally imposed in a controlled process using an abrasive.

In operations involving the recovery of natural gas and crude oil, the abrasiveness of the minerals (which may be in the form of highly abrasive particulate matter) in the formation is a factor of considerable importance. Shale, which is the basis for the formation of tight formations, varies widely in abrasiveness and this factor may need to be considered when drilling into such formations for the recovery of natural gas and crude oil. Abrasion taking place in a shale formation can be classified according to the size of the attack angle in places subjected to wear. The attack angle is the angle between the axis of flow and tangent line of the surface. Depending on the angle of fuel moving with respect to contact surfaces, the attacks are classified as straight line attacks (impact to 90°) and oblique or slipping attacks (less than 90°). On the other hand, both carbonate minerals and clay minerals (that also occur in tight formations) have a relatively low abrasive ability while the abrasiveness of quartz is high. In fact, the abrasiveness of shale may be determined more by the nature of its associated impurities, such as the individual grains of sandstone, a common impurity in some shale or formations, which are render the mined shale harder and more abrasive.

Comparison of abrasion index of any formation is an important aspect of the recovery of natural gas and crude oil from tight shale formations. However, some formations

are less abrasive than others because the abrasive minerals in the formation may be diluted by comparatively non-abrasive organic matter and relatively nonabrasive mineral matter.

The abrasion index (sometimes referred to as the *wear index*) is a measure of equipment (such as drill bit) wear and deterioration. At first approximation the wear is proportional to the rate of fuel flow in the third power and the maximum intensity of wear in millimeters) can be expressed:

$$\delta pl = \alpha \eta k m \omega^3 \tau$$

$\delta pl$  – maximum intensity of plate wear, mm.

$\alpha$  – abrasion index, mm<sup>3</sup>/g h.

$\eta$  – coefficient, determining the number of probable attacks on the plate surface.

$k$  – concentration of fuel in flow, g/m<sup>3</sup>.

$m$  – coefficient of wear resistance of metal;

$\omega$  – velocity of fuel flow, meters/sec.

$\tau$  – operation time, hours.

The resistance of materials and structures to abrasion can be measured by a variety of test methods (Table) which often use a specified abrasive or other controlled means of abrasion. Under the conditions of the test, the results can be reported or can be compared to items subjected to similar tests. These standardized measurements can be employed to produce two sets of data: (1) the *abrasion rate*, which is the amount of mass lost per 1,000 cycles of abrasion, and (2) the *normalized abrasion rate*, which is also called the *abrasion resistance index* and which is the ratio of the abrasion rate (i.e., mass lost per 1,000 cycles of abrasion) with the known abrasion rate for some specific reference material.

**Table** Examples of selected ASTM standard test method for determining abrasion\*.

ASTM B611 Test Method for Abrasive Wear Resistance of Cemented Carbides
ASTM C131 Standard Test Method for Resistance to Degradation of Small-Size Coarse Aggregate by Abrasion and Impact in the Los Angeles Machine
ASTM C535 Standard Test Method for Resistance to Degradation of Large-Size Coarse Aggregate by Abrasion and Impact in the Los Angeles Machine
ASTM C944 Standard Test Method for Abrasion Resistance of Concrete or Mortar Surfaces by the Rotating-Cutter Method
ASTM C1353 Standard Test Method for Abrasion Resistance of Dimension Stone Subjected to Foot Traffic Using a Rotary Platform, Double-Head Abraser
ASTM D 2228 Standard Test Method for Rubber Property – Relative Abrasion Resistance by the Pico Abrader Method
ASTM D4158 Standard Guide for Abrasion Resistance of Textile Fabrics, see Martindale method
ASTM D7428 Standard Test Method for Resistance of Fine Aggregate to Degradation by Abrasion in the Micro-Deval Apparatus
ASTM G81 Standard Test Method for Jaw Crusher Gouging Abrasion Test
ASTM G105 Standard Test Method for Conducting Wet Sand/Rubber Wheel Abrasion Tests
ASTM G132 Standard Test Method for Pin Abrasion Testing
ASTM G171 Standard Test Method for Scratch Hardness of Materials Using a Diamond Stylus
ASTM G174 Standard Test Method for Measuring Abrasion Resistance of Materials by Abrasive Loop Contact

\*ASTM International, West Conshohocken, Pennsylvania; test methods are also available from other standards organizations.

# Absorption

In the gas processing industry, absorption is a physical or chemical process by which the gas is distributed throughout an absorbent (liquid); depends only on physical solubility and may include chemical reactions in the liquid phase (*chemisorption*). Absorption is generally used to separate a higher-boiling constituent from other components of a system of vapors and gases. The absorption medium is usually a liquid and the process is widely employed in the recovery of natural gasoline from natural gas streams and of vapors given off by storage tanks.

Liquid absorption processes (which usually employ temperatures below 50 °C (<120 °F)) are classified either as physical solvent processes or chemical solvent processes. The former processes employ an organic solvent, and low temperatures, or high pressure, or both enhance absorption; regeneration of the solvent is often accomplished readily. On the other hand, in chemical solvent processes, absorption of the acid gases is achieved mainly by use of alkaline solutions such as amine derivatives (Figure 1) or carbonate derivatives (Figure 2) in which a chemical reaction occurs between the solvent and the contaminant(s). Regeneration (desorption) can be brought about by use of reduced pressures and/or high temperatures, whereby the acid gases are stripped from the solvent.

If absorption is a physical process not accompanied by any other physical or chemical process, it usually follows the Nernst partition law in which the ratio of concentrations of solute species in two bulk phases in contact is constant for a given solute and bulk phases, i.e.:

$$\frac{[x]_1}{[x]_2} = \text{constant} = K_{N(x,12)}$$

The value of constant  $K_N$ , the partition coefficient, is dependent upon temperature and the value is valid if concentrations are not too large and if the species  $x$  does not change its chemical or physical form in either phase-1 or phase-2. In the case of gas absorption, the concentration a solute ( $c$ ) in one of the phases can be calculated using the *Ideal gas law* (e.g.,  $c = p/RT$ ). Alternatively, partial pressure may be used instead of concentration.

In a gas processing plant, the absorption oil has an *affinity* for the natural gasoline constituents. As the natural gas or refinery gas (or mixture thereof) is passed through an absorption tower, it is brought into contact with the (*lean*) absorption oil which soaks up a high proportion of the liquid hydrocarbons. The *rich* absorption oil now containing the hydrocarbons exits the absorption tower through the base after which it is fed into lean oil stills, where the mixture is heated to a temperature above the boiling point of the absorbed hydrocarbons but below that of the oil. This process allows for the recovery of approximately 75% v/v of butanes, and 85 to 90% v/v of pentanes and higher boiling hydrocarbons from the stream.

The process above can be modified to improve its effectiveness, or to target the extraction of specific hydrocarbons. In the refrigerated oil absorption method, where the lean oil is cooled through refrigeration, propane recovery can be upwards of 90% v/v and around 40% v/v of any ethane present in the gas stream. Extraction of higher molecular weight hydrocarbons approaches 100% v/v using this process.

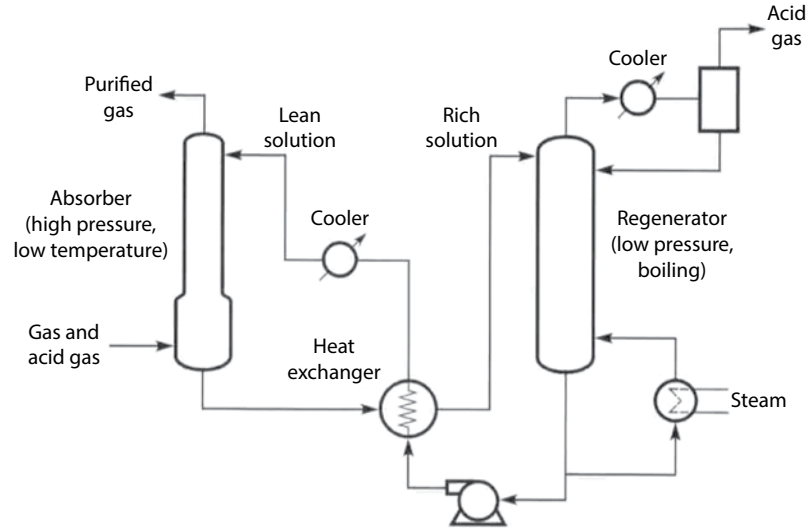

**Figure 1** Physical absorption process for gas cleaning.

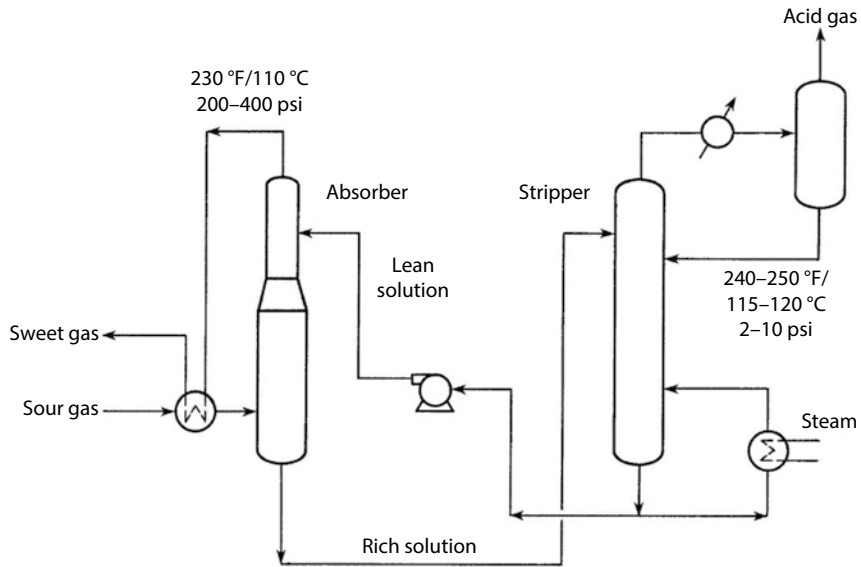

**Figure 2** The hot carbonate process.

# Acid Gas Removal

Natural gas, while ostensibly being hydrocarbon (predominantly methane) in nature, contains large amounts of acid gases such as hydrogen sulfide (H<sub>2</sub>S) and carbon dioxide (CO<sub>2</sub>) as or even process gas that contains significant amounts of hydrogen sulfide, carbon dioxide, or similar contaminants. Acid gas removal (*acid gas treating*, sometimes also referred to as *acid gas scrubbing*) is the removal of acidic gases such as hydrogen sulfide and carbon dioxide from natural gas or from process gas streams. The process for removing hydrogen sulfide and carbon dioxide from sour gas is commonly referred to as *sweetening* the gas.

To sweeten the high acid content gas, it is first pre-scrubbed to remove entrained brine, hydrocarbons, and other substances. The sour gas then enters an absorber, where lean amine solution chemically absorbs the acid gas components, as well as a small portion of hydrocarbons, rendering the gas ready for processing and sale. An outlet scrubber removes any residual amine, which is regenerated for recycling. Hydrocarbon contaminants entrained in the amine can be separated in a flash tank and used as fuel gas or sold. Process efficiency can be optimized by mixing different types of amine to increase absorption capacity, by increasing the amine concentration, or by varying the temperature of the lean amine absorption process.

Acid gas removal (i.e., removal of carbon dioxide and hydrogen sulfide from natural gas streams) is achieved by application of one or both of the following process types: (1) absorption and, (2) adsorption (Figure 1). The processes for acid gas removal involve the chemical reaction of the acid gases with a solid oxide (such as iron oxide) or selective absorption of the contaminants into a liquid (such as ethanolamine) that is passed countercurrent to the gas. Then the absorbent is stripped of the gas components (regeneration) and recycled to the absorber. The process design will vary and, in practice, may employ multiple absorption columns and multiple regeneration columns.

Liquid absorption processes (which usually employ temperatures below 50 °C (120 °F) are classified either as *physical solvent processes* or *chemical solvent processes*. The former processes employ an organic solvent, and absorption is enhanced by low temperatures, or high pressure, or both. Regeneration of the solvent is often accomplished readily. In chemical solvent processes, absorption of the acid gases is achieved mainly by use of alkaline solutions such as amines or carbonates. Regeneration (desorption) can be brought about by use of reduced pressures and/or high temperatures, whereby the acid gases are stripped from the solvent.

The most well-known hydrogen sulfide removal process is based on the reaction of hydrogen sulfide with iron oxide (*iron sponge process* or *dry box method*) in which the gas is passed through a bed of wood chips impregnated with iron oxide:

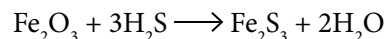

The bed is then regenerated by passage of air through the bed:

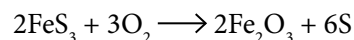

The bed is maintained in a moist state by circulation of water or a solution of soda ash. The method is suitable only for small-to-moderate quantities of hydrogen sulfide. Approximately 90% of the hydrogen sulfide can be removed per bed but bed clogging by elemental sulfur occurs and the bed must be discarded, and the use of several beds in series is not usually economical. Removal of larger amounts of hydrogen sulfide from gas streams requires continuous processes, such as the Ferrox process or the Stretford process.

The Ferrox process is based on the same chemistry as the iron oxide process except that it is fluid and continuous. The Stretford process employs a solution containing vanadium salts and anthraquinone disulfonic acid. Most hydrogen sulfide removal processes involve fairly simple chemistry with the potential for regeneration with return of

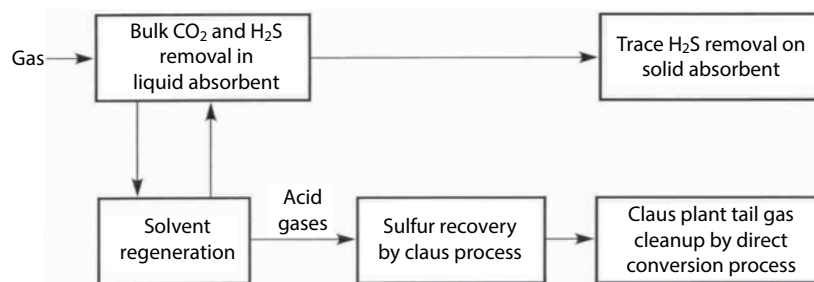

Figure 1 Acid gas removal processes.

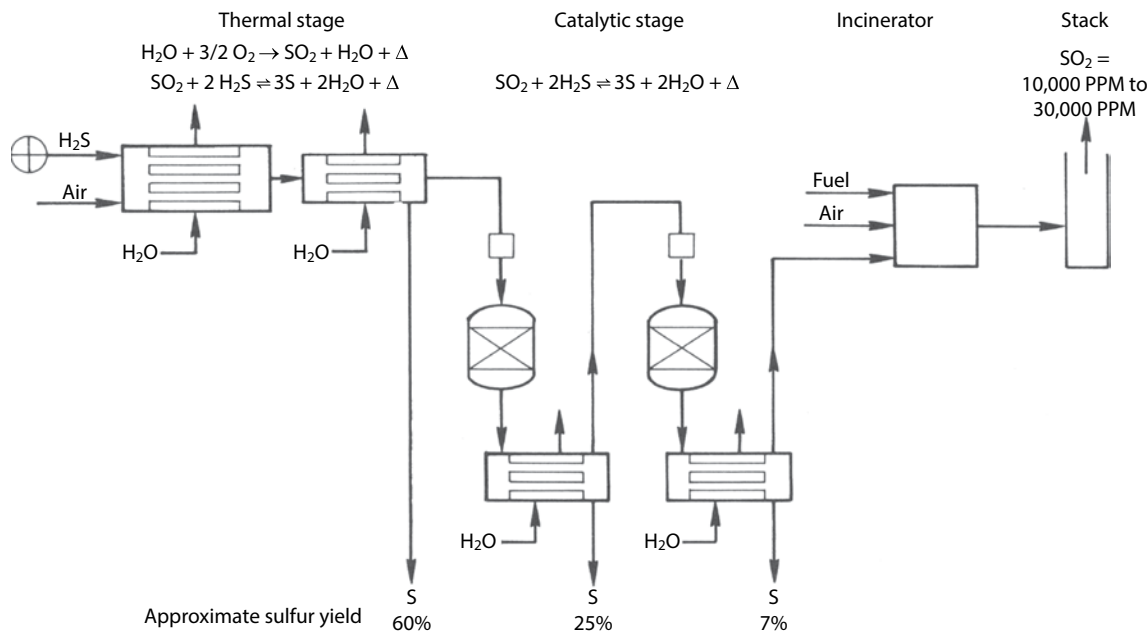
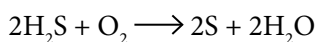
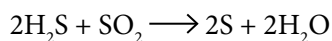
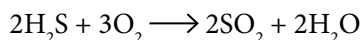

Figure 2 The Claus process.

the hydrogen sulfide. However, if the quantity involved does not justify installation of a sulfur recovery plant, usually a Claus plant, it is will be necessary to select a process which produces elemental sulfur directly:



The conversion can be achieved by reacting the hydrogen sulfide gas directly with air in a burner reactor if the gas can be burnt with a stable flame.

Other equilibria which should be taken into account are the formation of sulfur dimer, hexamer, and octamer as well as the dissociation of hydrogen sulfide:

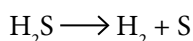

Carbonyl sulfide and carbon disulfide may be formed, especially when the gas is burned with less than the

stoichiometric amount of air in the presence of hydrocarbon impurities or large amounts of carbon dioxide.

Equilibrium conversion is almost complete (approximately 99 to 100%) at relatively low temperatures and diminishes at first at higher temperatures, in accordance with the exothermic nature of the reaction. A further rise in temperature causes the equilibrium conversion to increase again. This is a consequence of the dissociation of the polymeric sulfur into monatomic sulfur.

Catalysis by alumina is necessary to obtain good equilibrium conversions: the thermal Claus reaction is fast only above 500 °C (930 °F). There is also a lower temperature limit which is not caused by low rates but by sulfur condensation in the catalyst pores and consequent deactivation of the catalyst. The lower limit at which satisfactory operation is still possible depends on the pore size and size distribution of the catalyst; with alumina-based catalysts having wide pores, the conversion proceeds satisfactorily at approximately 200 °C (390 °F).

In all configurations of the Claus process (Figure 2), several conversion steps in adiabatic reactors are used, with intermittent and final condensation of the sulfur produced.

There are three main process forms, depending on the concentration of hydrogen sulfide and other sulfur compounds in the gas to be converted, i.e., the straight-through, the split-flow oxidation process. The straight-through process is applicable when the gas stream contains more than 50% v/v hydrogen sulfide. Feed gases of this type can be burnt with the stoichiometric amount of air to give sulfur.

The combustion reactor is followed by a combined waste heat boiler and sulfur condenser from which liquid sulfur and steam are obtained. The gases are then reheated by in-line fuel combustion to the temperature of the first catalytic convertor, which is usually kept at about 350 °C (660 °F) to decompose any carbonyl sulfide and any carbon disulfide formed in the combustion step. A second catalytic convertor, operating at as low a temperature as possible, is also employed to obtain high final conversions.

If the gas stream contains sulfur dioxide (also an acid gas), as is often the case when sulfur-containing fuels have been combusted, the typical sorbent slurries or other materials used to remove the sulfur dioxide from the flue gases are alkaline. The reaction taking place in wet scrubbing using a limestone ( $\text{CaCO}_3$ ) slurry produces calcium sulfite ( $\text{CaSO}_3$ ):

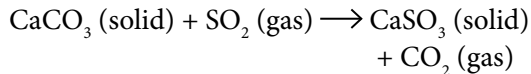

When wet scrubbing with a lime slurry [ $\text{CaO} + \text{H}_2\text{O}$  or  $\text{Ca}(\text{OH})_2$ ] the reaction also produces calcium sulfite:

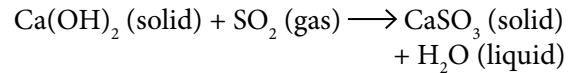

When wet scrubbing with a magnesium oxide slurry [ $\text{MgO} + \text{H}_2\text{O}$  or  $\text{Mg}(\text{OH})_2$ ] slurry, the reaction produces magnesium sulfite ( $\text{MgSO}_3$ ):

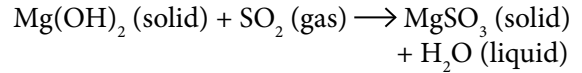

In some designs, the calcium sulfite is oxidized to produce calcium sulfate (gypsum,  $\text{CaSO}_4 \cdot 2\text{H}_2\text{O}$ ):

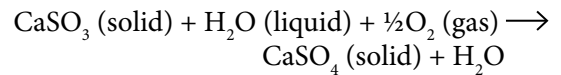

Seawater is also used to absorb sulfur dioxide; the sulfur dioxide is absorbed in the water and when oxygen is added reacts to form sulfate ions ( $\text{SO}_4^{2-}$ ) and free protons ( $\text{H}^+$ ) which result in the release of carbon dioxide from the carbonates in the seawater:

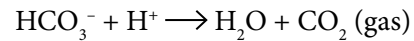
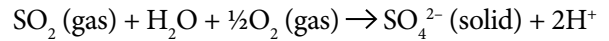





# Acid Gas Scrubbing

Sulfur dioxide is an acid gas and thus the typical sorbent slurries or other materials used to remove the sulfur dioxide from the flue gases are alkaline. The reaction taking place in wet scrubbing using a limestone ( $\text{CaCO}_3$ ) slurry produces calcium sulfite ( $\text{CaSO}_3$ ):

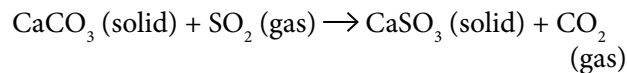

When wet scrubbing with a lime [ $\text{Ca}(\text{OH})_2$ ] slurry, the reaction also produces calcium sulfite:

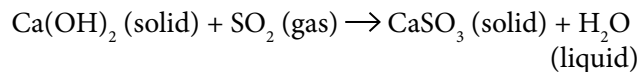

When wet scrubbing with a magnesium hydroxide [ $\text{Mg}(\text{OH})_2$ ] slurry, the reaction produces magnesium sulfite ( $\text{MgSO}_3$ ):

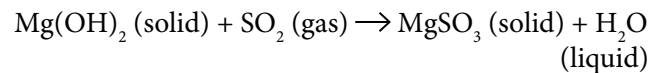

In some designs, the calcium sulfite is oxidized to produce calcium sulfate (gypsum,  $\text{CaSO}_4 \cdot 2\text{H}_2\text{O}$ ):

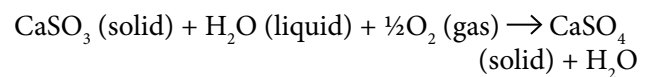

Seawater is also used to absorb sulfur dioxide; the  $\text{SO}_2$  is absorbed in the water and when oxygen is added reacts to form sulfate ions ( $\text{SO}_4^{2-}$ ) and free protons ( $\text{H}^+$ ) which result in the release of carbon dioxide from the carbonates in the seawater:

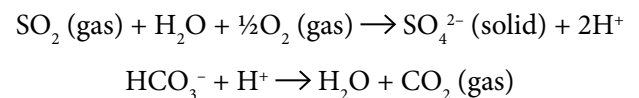



# Acid Number

The *acid number* (*acid value*, *neutralization number*, *acidity*) is the mass of potassium hydroxide (KOH) in milligrams that is required to neutralize one gram of the substance. The acid number (AN) or the total acid number (TAN) of crude oil is a measure of the amount of carboxylic acid groups and other acidic species (such as phenols and hydroxynaphthalene derivatives, also known as naphthol derivatives) in crude oil and indicates to the potential corrosion during refining. The determination of the total acid number is an essential part of the assay procedure for high acid crude oils and opportunity crude oils.

The acid number is used to quantify the amount of acid present and is the quantity of base, expressed in milligrams of potassium hydroxide, that is required to neutralize the acidic constituents in 1 g of sample.

$$AN = (V_{eq} - b_{eq})N \frac{56.1}{W_{oil}}$$

$V_{eq}$  is the amount of titrant (ml) consumed by the crude oil sample and 1 ml spiking solution at the equivalent point,  $b_{eq}$  is the amount of titrant (ml) consumed by 1 ml spiking solution at the equivalent point, and 56.1 is the molecular weight of potassium hydroxide.

The molarity concentration of titrant (N) is calculated as such:

$$N = \frac{1000W_{KHP}}{204.23V_{eq}}$$

$W_{KHP}$  is the amount (g) of KHP in 50 ml of KHP standard solution,  $V_{eq}$  is the amount of titrant (ml) consumed by 50 ml KHP standard solution at the equivalent point, and 204.23 is the molecular weight of KHP. While crude oils with high total acid numbers (TAN = 0.5–5 mg KOH/g) are not limited to heavy oils (<20° API), crude oils with extremely high TAN values (>5 mg KOH/g).

In a typical procedure (ASTM D664, ASTM D974), a known amount of sample dissolved in organic solvent is titrated with a solution of potassium hydroxide with known concentration and with phenolphthalein as a color indicator. It has been reported that crude oils with the highest TAN values are those with the lowest sulfur contents, which suggests that sulfur-containing compounds contribute little to the crude oil acidity. A number of non-biodegraded oils also show relatively high acidity, indicating that factors other than biodegradation (such as reservoir configuration as, for example, in vertically stacked oil reservoirs) lead to the later addition of fresh oils from one member of the stack to an earlier biodegraded oil reservoir in another member of the stack.



# Acid Rain

*Acid rain* is the more familiar term for *acid deposition*, which also includes *acid fog*, *acid sleet*, and *acid snow*. Acid rain occurs when sulfur oxides (SO<sub>2</sub> and SO<sub>3</sub>) and nitrogen oxides (NO<sub>x</sub>) are transformed in the atmosphere and return to the earth as dry deposition or in rain, fog, or snow. It is generally believed (the chemical thermodynamics are favorable) that acidic compounds are formed when sulfur dioxide and nitrogen oxide emissions are released from tall industrial stacks. Gases such as sulfur oxides (usually sulfur dioxide, SO<sub>2</sub>) as well as the nitrogen oxides (NO and NO<sub>2</sub>) react with the water in the atmosphere to form acids. Acid rain formation can be represented by a series of simple chemical equations:

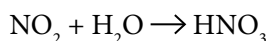
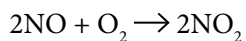
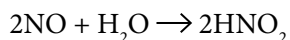
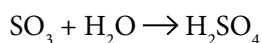
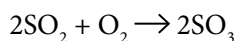
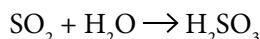

Also, in the gas phase, sulfur dioxide is oxidized (by reaction with the hydroxyl radical or by reaction with oxygen) via an intermolecular reaction:

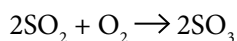
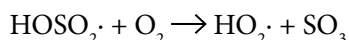
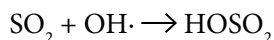

Acid rain has a pH less than 5.0 and predominantly consists of sulfuric acid (H<sub>2</sub>SO<sub>4</sub>) and nitric acid (HNO<sub>3</sub>). As a point of reference, in the absence of anthropogenic pollution

sources the average pH of rain is approximately 6.0 (slightly acidic; neutral pH = 7.0). In summary, the sulfur dioxide that is produced during a variety of processes will react with oxygen and water in the atmosphere to yield environmentally detrimental sulfuric acid. Similarly, nitrogen oxides will also react to produce nitric acid.

In high concentrations, acid rain can cause damage to natural environments including forests and freshwater lakes. This form of acid deposition is known as *wet deposition*. A second method of acid deposition is known as *dry deposition*. Whilst wet deposition involves the precipitation of acids, dry deposition occurs when the acids are first transformed chemically into gases and salts, before falling under the influence of gravity back to Earth. Sulfur dioxide, for example, is deposited as a gas and as a salt.

Another acid gas, hydrogen chloride (HCl), although not usually considered to be a major emission, is produced from mineral matter and the brines that often accompany petroleum during production and is gaining increasing recognition as a contributor to acid rain. However, hydrogen chloride may exert severe local effects because it does not need to participate in any further chemical reaction to become an acid. Under atmospheric conditions that favor a buildup of stack emissions in the areas where hydrogen chloride is produced, the amount of hydrochloric acid in rainwater could be quite high.

In addition to hydrogen sulfide and carbon dioxide, gas may contain other contaminants, such as mercaptans (RSH) and carbonyl sulfide (COS). The presence of these impurities may eliminate some of the sweetening processes since some processes remove large amounts of acid gas but not to a sufficiently low concentration. On the other hand, there are those processes that are not designed to remove (or are incapable of removing) large amounts of acid gases. However, these processes are also capable of removing the acid gas impurities to very low levels when the acid gases are there in low to medium concentrations in the gas.



# Acid-Base Catalysts

Acid-base catalysts promote reactions requiring proton transfer as a key step of the reaction mechanism. Redox catalysts (which are catalysts in which electrons are exchanged instead of protons) are characterized by electron transfer mechanisms, although they are mainly used, on the contrary, for promoting oxidation reactions occurring by cyclic reduction and oxidation of the catalyst. However, more properly, redox catalysts are oxidation catalysts operating through a redox cycle in which the catalyst is continuously reduced and reoxidized.

The amount and nature of the catalyst in both cases remain unchanged at the end of the reaction, as usually occurs for any kind of catalyst. Besides, catalysts cannot alter the equilibrium of the promoted reactions. Reactions that are catalyzed by acids are, normally, catalyzed also by bases. In the most general case, for a reaction occurring in aqueous solution, the kinetics of the reaction can be represented by:

$$r = k_{\text{exp}} C = [k_o + k_{\text{H}_3\text{O}^+} C_{\text{H}_3\text{O}^+} + k_{\text{OH}^-} C_{\text{OH}^-} + k_{\text{HA}} C_{\text{HA}} + k_{\text{A}^-} C_{\text{A}^-}] C$$

where  $r$  is the reaction rate,  $k_o$  is the intrinsic activity,  $C$  is the reagent concentration, and the catalyst concentration appears in the form  $\text{H}_3\text{O}^+$ ,  $\text{OH}^-$ , non-dissociated acid  $\text{HA}$  and anion  $\text{A}^-$ .

The acidity and/or basicity of an aqueous solution can be satisfactorily defined by relating it to the thermodynamic function  $\text{pH} = -\text{Log} [\text{H}_3\text{O}^+]$ . In the case of non-aqueous strong acid solvents, the concentration of the most acidic species and basic species in solution can be determined by the autoprotolysis equilibrium. For pure sulfuric acid, for example:

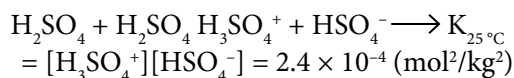

The acid strength, in this case, can be determined indirectly, by using a particular indicator and the Hammet function:

$$H_o = \text{p}K_a + \log \frac{C_B}{C_{\text{BH}^+}}$$

$C_{\text{BH}^+}$  and  $C_B$  are respectively the concentration of the dissociated and non-dissociated form of the indicator.

When these two concentrations are equal, the Hammet function equates the  $\text{p}K_a$  of the indicator and this last value becomes a measure of the acid strength. 100% sulfuric acid, for example, has an acid strength of  $-H_o = 12$ , substances having  $-H_o$  values greater than 12 are classified as superacids. The same approach can be extended to solid acid catalysts.

It is possible to develop acidity inside the porous crystalline framework of a zeolite. Zeolites are crystalline silico-aluminates with molecular-scale cavities related to Y zeolite. In the same figure the structural components always occurring in zeolite structures are also reported. Many zeolites are obtained by crystallization and precipitation in hydrothermal conditions (such as ZSM5), often in the presence of a chemical agent such as a quaternary ammonium salt. Zeolites are, normally, obtained in a neutral form containing sodium ions in the cavities. There are three different methods for introducing acidity in zeolites cavities: the direct exchange of sodium with  $\text{H}_3\text{O}^+$  that is possible only with acid resistant zeolites (for example, mordenite) and gives place to de-alumination, the exchange with the ammonium ion ( $\text{NH}_4^+$ ) followed by thermal treatment for decomposing the ammonium compound formed and the exchange with multi-charged cations such as calcium ( $\text{Ca}^{2+}$ ) or magnesium ( $\text{Mg}^{2+}$ ). The acidity is originated inside the zeolite cavities in the same way seen for silica-alumina support by the presence of tetrahedral aluminium inside the silica structure. By reducing the aluminium/silicon ratio in zeolites, different crystalline structures can be obtained from X and Y zeolites, to mordenite, ZSM5 and ZSM11.

Basic catalysts can be: supported basic compounds, alkaline earth basic oxides or oxide mixture (such as perovskite or hydrotalcite). Basicity can be measured in ways that are similar to the ones described for acidity by using indicators and probe molecules of opposite character.





# Acidity and Alkalinity

pH is given as the negative logarithm of  $[H^+]$  or  $[OH^-]$  and is a measurement of the acidity of a solution and can be compared by using the following:

$$pH = -\log([H^+])$$

$$pH = -\log([OH^-])$$

$[H^+]$  or  $[OH^-]$  are hydrogen and hydroxide ion concentrations, respectively, in moles/litter.

Also, at room temperature,  $pH + pOH = 14$ . For other temperatures:

$$pH + pOH = pK_w$$

$K_w$  is the ion product constant at that particular temperature. At room temperature, the ion product constant for water is  $1.0 \times 10^{-14}$  moles/litter (mol/L or M). A solution in which  $[H^+] > [OH^-]$  is acidic, and a solution in which  $[H^+] < [OH^-]$  is basic.

**Table** Ranges of acidity and alkalinity.

<b>pH</b>	<b>[H<sup>+</sup>]</b>	<b>Solution</b>
<7	$>1.0 \times 10^{-7}$ M	Acid
7	$1.0 \times 10^{-7}$ M	Neutral
>7	$<1.0 \times 10^{-7}$ M	Basic



# Acidizing

Acidizing is the injection of acid into the wellbore to improve well productivity by removing near-well formation damage and other damaging substances. The procedure commonly enhances crude oil production by increasing the effective radius of the well. When performed at pressures above the pressure required to fracture the formation, the procedure is often referred to as acid fracturing.

Damaged wells are those which suffer a restriction in flow rate. This may be due to a number of causes, for example, drilling damage or buildup of carbonate scale. Damage may occur at the wellbore face or as a zone of reduced permeability extending several inches or even feet into the formation, which severely restricts productivity. If the damage can be removed, significant increases in production rate can be achieved. Thus, removal of near-well bore damage can result in significant stimulation. Treatment normally involves injecting 15% v/v HCl followed by a sufficient after-flush of water or hydrocarbon to clear all acid from wellbores. A corrosion inhibitor is added to the acid to protect wellbores during exposure to acid. Other additives, such as anti-sludge agents, iron chelating agents, de-emulsifiers and mutual solvents are added as required for a specific formation.

Acidizing has been applied to wells in oil and gas bearing rock formations for many years. Acidizing is probably the most widely used work-over and stimulation practice in the oil industry. By dissolving acid soluble components within underground rock formations, or removing material at the wellbore face, the rate of flow of oil or gas out of production wells or the rate of flow of oil-displacing fluids into injection wells may be increased.

A number of different acids are used in conventional acidizing treatments. The most common are: hydrochloric acid (HCl) hydrofluoric acid (HF), acetic acid ( $\text{CH}_3\text{COOH}$ ), formic acid ( $\text{HCOOH}$ ), sulfamic acid ( $\text{H}_2\text{NSO}_3\text{H}$ ), and chloroacetic acid ( $\text{ClCH}_2\text{COOH}$ ). These acids differ in their characteristics and choice of the acid and any additives for a given situation depends on the underground

reservoir characteristics and the specific intention of the treatment such as near-well bore damage removal or dissolution of scale in fractures. As examples, hydrofluoric (HF) acid dissolves clay and fine particles in sandstones while hydrochloric acid (HCl) etches wormholes that bypass damage in carbonates. However, the majority of acidizing treatments carried out utilize hydrochloric acid (HCl). All conventional acids including hydrochloric acid and organic acids react very rapidly on contact with acid sensitive material in the wellbore or formation.

Worm-holing is a common phenomenon. The rapid reaction means the acid does not penetrate very far into the formation before it is spent. Conventional acid systems are therefore of limited effectiveness in treatments where deep acid penetration is needed. Problems in placing acid are compounded in long horizontal or directional wells. In these wells it is difficult to achieve truly uniform placement of acid along the well-bore, which may be several thousand meters long, let alone achieve uniform stimulation of the surrounding formation.

Methods which have been developed to slow the acidizing process include: (1) emulsifying the aqueous acid solutions in oil (or solvents such as kerosene or diesel fuel) to produce an emulsion which is slower reacting, (2) dissolving the acids in a non-aqueous solvent, and (3) the use of non-aqueous solutions of organic chemicals which release acids only on contact with water. In addition to these methods, of which emulsifying the acid is probably the most important, some retardation of the reaction rate can be achieved by gelling the acid or oil wetting the formation solids.

*Gelled acids* are used to retard acid reaction rate in treatments such as acid fracturing. Retardation results from the increased fluid viscosity reducing the rate of acid transfer to the fracture wall. Use of the gelling agents (normally water soluble polymers) is limited to lower temperature formations as most gelling agents degrade rapidly in acid solution at temperatures above 55 °C (130 °F). Gelling agents are

seldom used in matrix acidizing because the increased acid viscosity reduces injectivity and may prolong the treatment with no net benefit i.e., the slower injection rate counters the benefit of a reduced reaction rate.

*Chemically retarded acids* are often prepared by adding an oil-wetting surfactant to the acid in an effort to create a physical barrier to acid transfer to the rock surface. In order to achieve this, the additive must adsorb on the rock surface and form a coherent film. Use of these acids often requires continuous injection of oil during the treatment. At high flow rates and high formation temperatures, adsorption is diminished and most of these materials become ineffective.

*Emulsified acids* may contain the acid as either the internal or the external phase. The former, which is more common, normally contains 10 to 30% hydrocarbon as the external phase and 15% hydrochloric acid as the internal phase. When acid is the external phase, the ratio of oil to acid is often about 2:1. Both the higher viscosity created by emulsification and the presence of the oil can retard the rate of acid transfer to the rock surface. This reduction in mass transfer rate, and its corresponding reduction in acid reaction rate, can increase the depth of acid penetration into the rock formation before the acid reacts with the rock or damaging material. Use of oil external emulsified acids may be limited by the increased frictional resistance to flow of these fluids down the well. The presence of surfactants in the acidizing fluid, to produce the emulsion, can affect the wetting characteristics of the rock formation i.e., change a water wet rock surface into an oil wet surface. This can necessitate remedial post-acidizing treatments to restore the rock surface to a water wet state if successful oil production is to be attained.

*Matrix acidizing* may also be used to increase formation permeability in undamaged wells. Where damage is thought to exist within the formation, the aim of the treatment is to achieve more or less radial acid penetration deep into the formation to increase the formation permeability around the wellbore. Deep penetration can only be achieved with retarded acid systems. Matrix stimulation techniques are performed without fracturing reservoir rock. Acid is used to remove drilling, completion, workover, or production damage. Solvents and surfactants like crude, condensate, diesel or mutual solvents are used to change pore fluid or formation wettability characteristics. Washes remove scale and other dispersible or soluble material from formations, perforations and casing.

In undamaged formations even significant permeability increases over a 3-meter to 6-meter radius around the wellbore will result in less dramatic stimulation than achieved

when removing damage. There is a practical limit of about a 50% increase in injectivity or productivity of undamaged oil or water wells which can be achieved using matrix stimulation.

*Fracture acidizing (fracing, fracking)* is the most widely used acidizing technique for stimulating limestone or dolomite formations. In an acid fracturing treatment, a pad fluid is injected into the formation at a rate higher than the reservoir matrix will accept. This rapid injection produces a buildup in wellbore pressure leading to cracking (fracturing) of the rock. Continued fluid injection increases the fracture's length and width. Acid (normally 15% HCl) is then injected into the fracture to react with the formation and create a flow channel (by etching of the fracture surface) that extends deep into the formation. This allows more reservoir fluid to drain into the wellbore along the new fractures once the well is put back on production.

The key to success is penetration of reactive acid along the fracture. Acid penetration is particularly important in low permeability carbonates which are frequently subject to scaling where small fractures meet larger fractures. Acid fracturing methods which can achieve deep acid penetration offer tremendous potential to solve scaling problems. The effective length of an acidized fracture is limited by the distance that acid travels along the fracture before it is spent. This is controlled by the acid fluid loss, the reaction rate and the fracture flow rate. This problem is particularly severe when the acid reaction rate is high owing to high formation temperature.

The acid fluid-loss mechanism is more complex than that of non-reactive fluids. In addition to diffusive leak off into the formation, flowing acid leaks off dynamically by dissolving the rock and producing wormholes. Wormholes are very detrimental in fracture acidizing. They greatly increase the effective surface area from which leak off occurs and are believed to affect acid fluid loss adversely. Acid leaks off predominantly from wormhole tips rather than the fracture face. As wormholing and excessive leak off occur, the leak-off rate exceeds the pump rate, and a positive net fracturing pressure cannot be maintained to keep the fracture open. At this point in the treatment, which may be as early as several minutes after starting to pump acid, the fracture extension slows or stops.

In the case of certain crude oils, the addition of acid may change the polarity of the oil, thereby interfering with the delicate balance of the constituents, and cause phase separation of higher molecular weight polar constituents leading to channel blockage.

# Adsorption

Adsorption is a process that occurs when a gas or liquid solute accumulates on the surface of a solid or a liquid (adsorbent), forming a film of molecules or atoms (*adsorbate*). It is different from absorption, in which a substance diffuses into a liquid or into a solid to form a solution. The term *sorption* encompasses both processes, while *desorption* is the reverse of the sorption process. *Adsorption* differs from *adsorption* in that it is not a physical-chemical phenomenon in which the gas is concentrated on the surface of a solid or liquid to remove impurities.

In terms of gas processing, the number of steps and the type of process (adsorption or absorption) used to produce

pipeline-quality natural gas most often depends upon the source and makeup of the wellhead production stream. In some cases, several of the steps may be integrated into one unit or operation, performed in a different order or at alternative locations, or not required at all. Usually, carbon is the adsorbing medium, which can be regenerated upon *desorption*. The quantity of material adsorbed is proportional to the surface area of the solid and, consequently, adsorbents are usually granular solids with a large surface area per unit mass. Subsequently, the captured gas can be desorbed with hot air or steam either for recovery or for thermal destruction.



# Adsorption Isotherm

The adsorption process is studied through the development of an *adsorption isotherm* which relates the amount of adsorbate ( $x$ ) adsorbed on the surface of adsorbent ( $m$ ) and pressure at constant temperature. Different adsorption isotherms have been developed by Freundlich, Langmuir, and by means of the Brunauer, Emmett, and Teller (BET) theory. Simply, the adsorption process can be represented as:

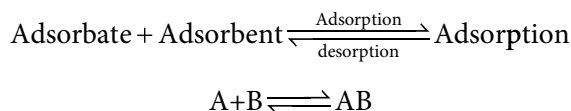

## Freundlich Adsorption Isotherm

The Freundlich gave an empirical expression representing the isothermal variation of adsorption of a quantity of gas adsorbed by unit mass of solid adsorbent with pressure:

$$\frac{x}{m} = kP^n$$

In this equation,  $x$  is the mass of the gas adsorbed on mass,  $m$ , of the adsorbent at pressure  $p$ ;  $k$ , and  $n$  are constants whose values depend upon adsorbent and gas at particular temperature. This isotherm establishes the relationship of adsorption with lower pressures but is not always suitable for high-pressure situations.

## Langmuir Adsorption Isotherm

The *Langmuir adsorption isotherm* is based on several assumptions, one of which is that dynamic equilibrium exists between adsorbed gaseous molecules and the free gaseous molecules:

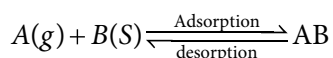

In this equation,  $A(g)$  is the unadsorbed gaseous molecule,  $B(s)$  is unoccupied metal surface and  $AB$  is adsorbed gaseous molecule from which a relationship between the number of active sites of the surface undergoing adsorption and pressure can be derived:

$$\theta = \frac{KP}{1 + KP}$$

Here,  $\theta$  is the number of sites of the surface which are covered with gaseous molecule,  $P$  is the pressure, and  $K$  is the equilibrium constant for distribution of adsorbate between the surface and the gas phase. However, the Langmuir adsorption equation is that it is valid at low pressure only. At lower pressure,  $KP$  is small and the factor  $1 + KP$  in denominator is close to unity, which the Langmuir equation reduces to:

$$\theta = KP$$

At high pressure  $KP$  is large and the factor  $1 + KP$  is almost equal to  $KP$  thereby reducing the Langmuir equation to:

$$\theta = \frac{KP}{KP} = 1$$

## BET Adsorption Isotherm

The BET theory (Brunauer, Emmett, and Teller) equation invokes the concept that under the condition of high pressure and low temperature, thermal energy of gaseous molecules decreases and more and more gaseous molecules would be available per unit surface area. As a result, multi-layer adsorption will occur and can be represented by the BET equation:

$$V_{total} = \frac{V_{mono} C \left( \frac{P}{P_0} \right)}{\left( 1 - \frac{P}{P_0} \right) \left( 1 + C \left( \frac{P}{P_0} \right) - \frac{P}{P_0} \right)}$$

Another form of the BET equation is:

$$\frac{P}{V_{total} (P - P_0)} = \frac{1}{V_{mono} C} + \frac{c-1}{V_{mono} C} \left( \frac{P}{P_0} \right)$$

In these equations,  $V_{mono}$  is the adsorbed volume of gas at high-pressure conditions so as to cover the surface with a unilayer of gaseous molecules. This:

$$C = K_1/K_L$$

$$\frac{K_1}{K_L}$$

$K_1$  is the equilibrium constant when single molecule adsorbed per vacant site and  $K_L$  is the equilibrium constant to the saturated vapor-liquid equilibrium.



# Adulteration

Adulteration differs from contamination insofar as unacceptable materials deliberately are added to gasoline for a variety of reasons not to be discussed here. Such activities may not only lower the octane number but will also adversely affect volatility, which in turn also affects performance. In some countries, dyes and markers are used to detect adulteration (for example, ASTM D86 distillation testing and/or ASTM D2699/ASTM D2700 octane number testing may be required to detect adulteration).

Specific types of adulteration may be broadly categorized as: (1) blending relatively small amounts of distillate fuels such as diesel or kerosene into automotive gasoline, (2) blending variable amounts of gasoline boiling range hydrocarbons such as industrial solvents into automotive gasoline, (3) blending small amounts of spent waste industrial solvents such as used lubricants – which would be costly to dispose of in an environmentally approved manner – into gasoline and diesel, (4) blending kerosene into diesel, often as much

as 20 to 30% v/v, and (5) blending small amounts of heavier fuel oils into diesel fuels.

Fuel adulteration can increase the tailpipe emissions of hydrocarbons, carbon monoxide, oxides of nitrogen, and particulate matter (PM). Air toxin emissions – which fall into the category of unregulated emissions – of primary concern are benzene and polynuclear aromatic hydrocarbons, both of which are well-known carcinogens. Air toxin emissions such as benzene depend mostly on fuel composition and catalyst performance. Polynuclear aromatic hydrocarbons in the exhaust are due primarily to the presence of polynuclear aromatic hydrocarbons in the fuel itself and, in the case of gasoline, in part due to the formation of polynuclear aromatic hydrocarbons formation by fuel combustion in the engine. Aside from fuel quality, the amounts of pollutants emitted depend on such parameters as the air-to-fuel ratio, engine speed, engine load, operating temperatures, whether the vehicle is equipped with a catalytic converter, and the condition of the catalyst.



# Air Emissions

Air emissions are generated from several sources in a refinery and gas processing plant, including: (1) combustion emissions associated with the burning of fuels in the refinery, including fuels used in the generation of electricity, (2) equipment leak emissions (fugitive emissions) released through leaking valves, flanges, pumps, or other process devices, (3) process vent emissions (point source emissions) released from process vents during manufacturing (e.g., venting, chemical reactions), (4) storage tank emissions released when products are transferred to and from storage tanks, and (5) wastewater system emissions from tanks, ponds and sewer system drains.

Air emissions from refineries and natural gas processing plants include fugitive emissions of the volatile constituents in crude oil and its fractions, emissions from the burning of fuels in process heaters, and emissions from the various refinery processes themselves. Fugitive emissions occur throughout refineries and arise from the thousands of potential fugitive emission sources such as valves, pumps, tanks, pressure relief valves, and flanges. While individual leaks are typically small, the sum of all fugitive leaks at a refinery can be one of its largest emission sources. Fugitive emissions can be reduced through a number of techniques, including improved leak resistant equipment, reducing the number of tanks and other potential sources and, perhaps the most effective method, an ongoing Leak Detection and Repair (LDAR) program.

The numerous process heaters used in refineries to heat process streams or to generate steam (boilers) for heating or steam stripping, can be potential sources of sulfur oxides ( $\text{SO}_x$ ), nitrogen oxides ( $\text{NO}_x$ ), carbon oxides ( $\text{CO}$ ,  $\text{CO}_2$ ), particulate matter, and hydrocarbon emissions (volatile organic compounds, VOCs). When operating properly and when burning cleaner fuels such as refinery fuel gas, fuel oil or natural gas, these emissions are relatively low. If, however, combustion is not complete, or heaters are

fired with refinery fuel pitch or residuals, emissions can be significant.

The three main greenhouse gases that are products of refining are carbon dioxide, nitrous oxide, and methane. Carbon dioxide is the main contributor to climate change. Methane is generally not as abundant as carbon dioxide but is produced during refining and, if emitted into the atmosphere, is a powerful greenhouse gas and more effective at trapping heat. However, gaseous emissions associated with petroleum refining and processing are more extensive than carbon dioxide and methane and typically include process gases, petrochemical gases, volatile organic compounds (VOCs), carbon monoxide ( $\text{CO}$ ), sulfur oxides ( $\text{SO}_x$ ), nitrogen oxides ( $\text{NO}_x$ ), particulates, ammonia ( $\text{NH}_3$ ), and hydrogen sulfide ( $\text{H}_2\text{S}$ ). These effluents may be discharged as air emissions and must be treated. However, gaseous emissions are more difficult to capture than wastewater or solid waste and, thus, are the largest source of untreated wastes released to the environment.

In addition to the corrosion of equipment by acid gases, the escape into the atmosphere of sulfur-containing gases can eventually lead to the formation of the constituents of acid rain, i.e., the oxides of sulfur ( $\text{SO}_2$  and  $\text{SO}_3$ ). Similarly, the nitrogen-containing gases can also lead to nitrous and nitric acids (through the formation of the oxides  $\text{NO}_x$ , where  $x = 1$  or  $2$ ) which are the other major contributors to acid rain. The release of carbon dioxide and hydrocarbons as constituents of refinery effluents can also influence the behavior and integrity of the ozone layer.

Emissions from the sulfur recovery unit typically contain some hydrogen sulfide ( $\text{H}_2\text{S}$ ), sulfur oxides, and nitrogen oxides. Other emissions sources from refinery processes arise from periodic regeneration of catalysts. These processes generate streams that may contain relatively high levels of carbon monoxide, particulates and volatile organic compounds (VOCs). Before being discharged to the atmosphere, such off-gas streams may be treated first through a carbon

monoxide boiler to burn carbon monoxide and any volatile organic compounds, and then through an electrostatic precipitator or cyclone separator to remove particulates.

The processes that have been developed to accomplish gas purification vary from a simple once-through wash

operation to complex multi-step recycling systems. In many cases, the process complexities arise because of the need for recovery of the materials used to remove the contaminants or even recovery of the contaminants in the original, or altered, form.

# Alcohol Blended Fuels

*Alcohol* refers to ethyl alcohol (ethanol,  $C_2H_5OH$ ), which has a high octane number (good antiknock performance) – the research octane number (RON) and the motor octane number (MON) is 91.6. If alcohol contains water, it is favorable to improve its antiknock performance; hence the enhancement of the compression ratio of the engine occurs when the blended fuel is burned. Meanwhile, an alcohol blend requires no or reduced additive of antiknock substance but

the effect on increasing of the octane number of blended fuel is not the same when gasoline is mixed with different kinds of alcohol.

*Blended fuel* usually refers to a mixture composed of automotive gasoline and another liquid, other than a minimal amount of a product such as carburetor detergent or oxidation inhibitor that can be used as a fuel in a motor vehicle.



# Alcohols

*Alcohol* is the family name of a group of organic chemical compounds composed of carbon, hydrogen, and oxygen and has fuel properties. The molecules in the series vary in chain length and are composed of a hydrocarbon plus a hydroxyl group. The alcohols are fuels of the family of oxygenates and the alcohol molecule has one or more oxygen, which contributes to the combustion.

Alcohols are named accordingly to the basic molecules of hydrocarbon which derives from them: methanol ( $\text{CH}_3\text{OH}$ ); ethanol ( $\text{C}_2\text{H}_5\text{OH}$ ); propanol ( $\text{C}_3\text{H}_7\text{OH}$ ); butanol ( $\text{C}_4\text{H}_9\text{OH}$ ), although menthol and ethanol are the most frequently used as fuel because of their distinguishing properties. Theoretically, any of the organic molecules of the alcohol family can be used as a fuel. The list is somehow more extensive; however, only two of the alcohols are technically and economically suitable as fuels for internal combustion engines. These alcohols are those of the simplest molecular structure, i.e., methanol and ethanol (Table).

Alcohols are *oxygenate* fuels insofar as the alcohol molecule has one or more oxygen, which decreases to the combustion heat. Practically, any of the organic molecules of the alcohol family can be used as a fuel. The alcohols can be used for motor fuels are methanol ( $\text{CH}_3\text{OH}$ ), ethanol ( $\text{C}_2\text{H}_5\text{OH}$ ), propanol ( $\text{C}_3\text{H}_7\text{OH}$ ), butanol ( $\text{C}_4\text{H}_9\text{OH}$ ). However, only

methanol and ethanol fuels are technically and economically suitable for internal combustion engines.

Ethanol (ethyl alcohol,  $\text{CH}_3\text{CH}_2\text{OH}$ ) is a clear, colorless liquid with a characteristic, agreeable odor that can be blended with gasoline to create E85 – a blend of 85% v/v ethanol and 15% v/v gasoline. Fuel with higher concentrations of ethanol (E95) and pure bioethanol (E100, ethanol produced from biomass materials) has been used successfully in Brazil. More widespread practice has been to add up to 20% v/v ethanol to gasoline (E20, also called *gasohol*) to avoid engine changes. E100-fueled and M100-fueled vehicles have difficulty starting in cold weather, but this is not a problem for E85 and M85 vehicles because of the presence of gasoline.

Ethanol has a higher octane number (108), broader flammability limit, higher flame speed, and a higher heat of vaporization than gasoline. These properties allow for a higher compression ratio, shorter burn time and leaner burn engine, which lead to theoretical efficiency advantages over gasoline in an internal combustion engine. On the other hand, the disadvantages of ethanol include its lower energy density than gasoline, corrosiveness, low flame luminosity, lower vapor pressure, miscibility with water, and toxicity to ecosystems.

Table Properties of methanol and ethanol compared to iso-octane.

Item	Iso-octane	Methanol	Ethanol
1. Formula	$C_8H_{18}$	$CH_3OH$	$C_2H_5OH$
2. Molecular weight	114.224	32.042	46.07
3. Carbon/Hydrogen (W)	5.25	3.0	4.0
4. Carbon, % w/w	84.0	37.5	52.17
5. Hydrogen, % w/w	16.0	12.5	13.4
6. Oxygen, % w/w	0	50.0	34.78
7. Boiling point @ 1 atmosphere °C	99.239	64.5	78.40
8. Freezing point @ 1 atmosphere °C	-107.378	-97.778	-80.00
9. Density @ 15.5 °C lb/gal	5.795	6.637	6.63
10. Viscosity @ 20 °C, Centipoise	0.503	0.596	1.20
11. Specific heat @ 25 °C/1 atm. BTU/lb	0.5	0.6	0.6
12. Heat of vaporization, @ boiling point/1 atm. BTU/lb	116.69	473.0	361.0
13. Heat of vaporization, @ 25 °C/1 atm. BTU/lb	132.0	503.3	
14. Heat of combustion @ 25 °C, BTU/lb			
(a) Higher heating value	20555	9776	12780
(b) Lower heating value	19065	8593	11550
15. Stoichiometric, lb air/lb fuel	15.13	6.463	9.0
16. Research octane number (RON)	100	106	105
17. Flash point temp. °C	-42.778	11.112	12.778
18. Auto-ignition temp. °C	257.23	463.889	422.778
19. Flammability limits			
(a) Lower	1.4	6.7	4.3
(b) Higher	7.6	36.0	19.0
20. Cetane number	-	5	8



# Alicyclic Hydrocarbons

Alicyclic hydrocarbons contain cyclic structures in all or part of the chemical skeleton. The saturated alicyclic hydrocarbons have the general formula  $C_nH_{2n}$ . When the molecular formula of a saturated hydrocarbon corresponds to the general formula  $C_nH_{2n-2}$  then the compound contains two rings or if the formula corresponds to  $C_nH_{2n-4}$ , the compound contains three rings. Their melting points, boiling points and densities of cycloalkane derivatives (Table) are higher than the alkane derivatives having the same number of carbon atoms. In crude oil, the most frequently found rings are those having five or six carbon atoms. In these rings, each hydrogen atom can be substituted by a paraffinic alkyl chain that is either a straight chain or branched. Monocyclic naphthene derivatives are major constituents of the light fraction. Monocyclic naphthene derivatives with carbon numbers on the order of  $C_{20}$ , to  $C_{30}$ , with long side chains can be isolated from paraffin waxes.

In the refinery system, cycloalkane derivatives (naphthene derivatives) catalytically crack by both ring and chain rupture and yield olefins and paraffin. In the case of hydrocracking process, polycyclic aromatic systems are partially hydrogenated rapidly. Naphthene rings in polycyclic compounds are readily removed by ring – opening followed by cracking. Single-ring naphthene derivatives and paraffin derivatives are more resistant to cracking. Also, single-ring naphthene derivatives appear to react more slowly at high conversion levels.

The stability of the cycloalkane derivatives increases up to the six-membered carbon ring, then decreases from the

seven-member carbon ring to the eleven-member ring, and from the twelve-member carbon ring onward the system attains the stability of two six-member carbon rings (Table).

**Table** Properties of selected alicyclic hydrocarbon derivatives.

Naphthene derivative	Melting point, °C	Boiling point, °C	Density, @20 °C
Cyclopropane	-127	-33	
Propane	-167	-42	
Cyclobutane	-80	13	
Butane	-138	0	
Cyclopentane	-94	49	0.746
Pentane	-130	36	0.626
Cyclohexane	6.5	81	0.778
Hexane	-95	69	0.659
Cycloheptane	-12	118	0.810
Heptane	-90	-98	0.684
Cyclooctane	14	149	0.830
Octane	-57	126	0.703
Methylcyclopentane	-142	72	0.749
Cis-1,2-dimethylcyclopentane	-62	99	0.772
Trans-1,2-dimethylcyclopentane	-120	92	0.750
Methylcyclohexane	-126	100	0.769



# Aliphatic Hydrocarbons

Aliphatic hydrocarbon derivatives (paraffins, paraffin derivative) are straight chain or branched saturated organic compounds with composition  $C_nH_{2n+2}$ . Paraffin derivatives of low molecular weight are found in natural gas while paraffin derivatives of medium and high molecular weight occur in petroleum. Methane ( $CH_4$ ) is the lowest member of the paraffin series of hydrocarbons. With the increase in size of molecule, several hydrocarbon derivatives having the same molecular formula (isomers) may exist. Hydrocarbon derivatives are classified into chemical families according to the structure. The carbon-carbon molecule chains have different chemical bond: (1) saturated hydrocarbons linked by single bond (given the suffix *ane*), and (2) unsaturated hydrocarbons linked by multiple bonds double bond  $C=C$  (suffix *ene*) or triple  $C\equiv C$  (suffix *yne*)

*Normal alkane derivatives (straight-chain paraffin derivatives)* consist of a chain of carbon atoms. Each carbon atom is linked to four atoms, which can be either carbon or hydrogen, their general formula  $C_nH_{2n+2}$ . The carbon skeleton can be structured as a straight chain, as in the normal paraffin derivatives,  $n-CH_3(CH_2)_nCH_3$ . The boiling point increases with the number of carbon atom and, at the same time the density increases with the molecular weight 0.626 kg/L for n-pentane ( $C_5H_{12}$ ), 0.791 kg/L for n-pentacosane ( $C_{25}H_{52}$ ), on the other hand, the density is always much lower than 1.

The normal alkane derivatives from  $C_1$  to  $C_4$  are colorless gases;  $C_5$  to  $C_{17}$  derivatives are colorless liquids; and from  $C_{18}$  onwards, colorless solids. Other physical properties, such as melting point, density, viscosity, also increase in the same way as boiling point (Table 1). There is a relationship between physical properties and chemical composition. The variation in boiling point of compounds is due to different intermolecular forces such as hydrogen bonding. The alkanes are insoluble in water.

*Iso-paraffins* (Table 2) are paraffins in which branching is present, usually at the number 2 carbon atom, although

**Table 1** Physical properties of n-paraffins.

Alkane	Melting point degree °C	Boiling point degree °C	Density g/ml @20 °C
Methane	-183	-162	
Ethane	-172	-88.5	
Propane	-167	-42	
Butane	-138	0	
Pentane	-130	36	0.626
Hexane	-95	69	0.659
Heptane	-90	98	0.684
Octane	-57	126	0.703
Nonane	-54	151	0.718
Decane	-30	174	0.730
Undecane	-26	196	0.740
Dodecane	-10	216	0.749
Tridecane	-6	234	0.757
Tetradecane	5.5	252	0.764
Pentadecane	10	266	0.769
Hexadecane	18	280	0.775
Heptadecane	22	292	
Octadecane	28	308	
Nonadecane	32	320	

**Table 2** Physical properties of selected branched paraffins (Iso-Paraffin Derivatives).

Paraffins	Melting point degree °C	Boiling point degree °C	Density g/ml @20 °C
Isobutane	-159	-12	
Isopentane	-160	28	0.620
Neopentane	-17	9.5	
Isohexane	-154	60	0.654
3-Methylbutane	-118	63	0.676
2,2-Dimethylbutane	-98	50	0.649
2,3-Dimethylbutane	-129	58	0.668

branching can take place at different positions in the chain, although such molecules are not strictly iso-paraffins. Iso-paraffins have a boiling point lower than normal paraffin with the same number of carbon atoms, and generally, the greater the branching the lower the boiling point (Table 3). Octane number is a measure of a fuel's ability to avoid knocking. The test engine is adjusted to give knock from the fuel rated. Then various mixtures of isooctane (2,2,4-trimethylpentane) and n-heptane are used to find the ratio of the two reference fuels that will give the same intensity knock as that from unknown fuel. Defining isooctane as 100 octane number and n-heptane as 0, the octane number is the volumetric percentage of isooctane in heptane that matches knock from the unknown fuel is reported as octane number of the fuel.

*Unsaturated aliphatic hydrocarbons (olefins)* have one or more double bonds between carbon atoms. Olefin has different types of isomers, for example butene ( $C_4H_8$ ) isomers, which have many arrangements including 1-butene, cis 2-butene, trans 2-butene and isobutene. Owing to the presence of a double bond, the alkene undergoes a large number of addition reactions, but under special conditions they also undergo substitution reactions. Alkene is readily hydrogenated under pressure in the presence of a catalyst. Platinum and palladium are effective at room temperature. Addition polymerization occurs between molecules containing double or triple bonds. The following are some reactions of aliphatic hydrocarbons to enhancement its properties.

Paraffin deposition (in the form of paraffin wax) creates diverse oil production problems and, in most cases, paraffin problems can be resolved efficiently and economically with chemical products. The wax is subjected to separation when

fuel is cooled. Crystallized wax precipitates from fuel oil are sufficiently low temperatures and the oil as well can completely solidify, reducing the ability to flow and/or ability for pumping.

**Table 3** Physical properties of selected olefins.

Olefin	Melting point degree °C	Boiling point degree °C	Density g/ml @20 °C
Ethylene	-169	-102	
Propylene	-158	-48	
1-Butene		-6.5	
1-Pentene		30	
1-Hexene	-138	63.5	0.643
1-Heptene	-119	93	0.675
1-Octene	-104	122.5	0.698
1-Nonene		146	0.716
1-Decene	-87	171	0.731
Cis-2-butene	-139	4	0.743
Trans-2-butene	-106	1	
Isobutylene	-141	-7	
Cis-2-pentene	-151	37	
2-Methyl-2-butene	-123	39	0.655
2,3-Dimethyl-2-butene	-74	73	0.660
	-93	46	0.705
Cyclopentene	-104	83	0.774
Cyclohexene	-85	42	0.810
1,3-Cyclopentadiene	-49	87	0.798
1,3-Cyclohexadiene			0.847

# Alloys – Composition

An alloy is a mixture of metals or a mixture of a metal and another element and is characterized by the metallic bonding character. An alloy may be a solid solution of metal elements (a single phase) or a mixture of metallic phases (two or more solutions). Intermetallic compounds are alloys with a defined stoichiometry and crystal structure.

Alloys are used in a wide variety of applications in the natural gas and petroleum industries. In some cases, a combination of metals may reduce the overall cost of the material while preserving important properties. In other cases, the combination of metals imparts synergistic properties to the constituent metal elements such as corrosion resistance or mechanical strength.

**Table** Compositions of selected common alloys\*.

Alloy class	Example	Constituents									
		Ni	Cr	Mo	Fe	Co	Ti	Cu	Cb	Al	V
Carbon steel	C10				>94						
Low Alloy Steel	1-1/4Cr 1/2Mo		1.25	0.5	balance						
Fe-Ni-Cr+Mo	Type 316L	13.0	17.0	2.3	balance						
	Alloy SO OH	32.5	21.0		4.6						
	20Cb-3	35.0	20.0	2.5	balance			3.5			
Ni-Cr-Mo	Alloy C2	54.0	15.5	16.0							
	Alloy C276	57.0	16.0	16.0	5.5						
	Alloy C4	54.0	16.0	15.5	3.0						
	Alloy 625	60.0	21.5	9.0					3.7		
Ni-Cr-Fe	Alloy G	45.0	22.2	6.5	19.5			2.0			
	Alloy 600	76.0	15.0		8.0						
Ni-Mo	Alloy B2	balance	1.0	28.0	2.0	1.0					
Ni-Cu	Alloy 400	65.1						32.0			
Nickel	Alloy 200	99.9									
Co-Base	ULTEMET (K)	9.0	26.0	5.0	3.0	54.0					
Ti-Base	Ti-6Al-4V						90			6.0	4.0

\*Alloys that are of use in the petroleum and natural gas industries.



# Amine Absorber

Amine absorbers use counter-current flow through a tray-tower or packed-tower to provide intimate contact between the amine solvent and the sour gas so that the hydrogen sulfide (H<sub>2</sub>S) and carbon dioxide (CO<sub>2</sub>) molecules can transfer from the gas-phase to the solvent liquid-phase. In tray columns, a liquid level is maintained on each tray by a weir usually two or three inches high. The gas passes up from underneath the trays through openings in the trays such as perforations, bubble caps, or valves, and disperses into bubbles through the liquid, forming a froth. The gas disengages from the froth, travels through a vapor space, providing time for entrained amine solution to fall back down to the liquid on the tray, and passes through the next tray above. In packed columns the liquid solvent is dispersed in the gas stream, by forming a film over the packing, providing a large surface area for carbon dioxide and hydrogen sulfide transfer from the gas to the liquid solvent. The degree of sweetening achieved is largely dependent on the number of trays or the height of packing available in the absorber.

Twenty valve-type trays (spaced 24 inches apart) or the equivalent height in packing column are common, and are often a standard design. Typically, small-diameter towers

use packing, while larger towers use stainless steel trays. The cross-sectional area of the contactor is sized for the gas and amine flow rates:

$$V_{SG} = 0.25 \left[ \frac{\rho_{\text{amine}} - \rho_{\text{gas}}}{\rho_{\text{gas}}} \right]^{0.5}, \text{ft/sec}$$

In most cases, a mist eliminator pad is installed near the gas outlet of the absorber (the distance between the top tray and the mist pad is three to four feet) to trap entrained solvent, and an outlet knockout drum, similar to the inlet separator for the gas feed, is provided to collect solvent carryover. Some contactors have a water wash consisting of two to five trays at the top of the absorber to minimize vaporization losses of amine, which is often found in low-pressure monoethanolamine systems.

In most cases, absorbers will have multiple feed points allowing the option of introducing the lean amine lower in the column or at multiple trays. If absorption of carbon dioxide is desired, all of the lean amine should, in general, be fed on the top tray, thus utilizing all available stages. For carbon dioxide slip, multiple feed points are typically better in some cases.





# Amine Condenser

Amine-stripper overhead condenser systems are typically air-cooled and are required to cool the overhead gases and condense the overhead steam to water. The condenser is used to treat the gas containing amine vapor and hydrogen sulfide and coming from the top section of the amine regeneration tower. The gas is cooled typically by heat exchange with cooling water so that the amine vapor is mostly condensed and pooled in a reflux drum before it is returned to the top section of the amine regeneration tower by means of a reflux pump.

The inlet temperature to the cooler is deduced using the partial pressure of the overhead steam to determine the

temperature from steam tables. The cooler outlet temperature is typically 55 to 63 °C (130 to 145 °F) depending on the ambient temperature. The heat duty and transfer area of an amine reflux condenser can be determined:

$$H_c = 18 \times 10^5 \times Q$$

$$A = 5.20 \times Q$$

$H_c$  is the heat duty of amine reflux condenser, Btu/min,  $Q$  is the amine circulation flow rate, gal/min.



# Amine Washing

*Amine washing* (more correctly: *olamine washing*) is the primary process for sweetening sour natural gas and is quite similar to the processes of glycol dehydration and removal of natural gas liquids by absorption. The process involves chemical reaction of the amine with any acid gases with the liberation of an appreciable amount of heat, and it is necessary to compensate for the absorption of heat. Amine derivatives (Table) such as ethanolamine (monoethanolamine, MEA), diethanolamine (DEA), triethanolamine (TEA), methyldiethanolamine (MDEA), di-isopropanolamine (DIPA), and diglycolamine (DGA) have been used in commercial applications.

The primary process for sweetening sour natural gas is quite similar to the processes of glycol dehydration and removal of natural gas liquids by absorption. In this case, however, amine (*olamine*) solutions are used to remove the hydrogen sulfide (the *amine process*). The sour gas is run through a tower, which contains the olamine solution. There are two principle amine solutions used, monoethanolamine (MEA) and diethanolamine (DEA). Either of these compounds, in liquid form, will absorb sulfur compounds from natural gas as it passes through. The effluent gas is virtually free of sulfur compounds, and thus loses its sour gas status. Like the process for the extraction of natural gas liquids and glycol dehydration, the amine solution used can be regenerated for reuse.

As currently practiced, acid gas removal processes involve the selective absorption of the contaminants into a liquid, such as an olamine (Table), which is passed countercurrent to the gas. Then the absorbent is stripped of the gas components (regeneration) and recycled to the absorber. The process design will vary and, in practice, may employ multiple absorption columns and multiple regeneration columns.

Liquid absorption processes (which usually employ temperatures below 50 °C (120 °F) are classified either as *physical solvent processes* or *chemical solvent processes*. The former processes employ an organic solvent, and absorption is enhanced by low temperatures, or high pressure, or both. Regeneration of the solvent is often accomplished readily. In

chemical solvent processes, absorption of the acid gases is achieved mainly by use of alkaline solutions such as amines or carbonates. Regeneration (desorption) can be brought about by use of reduced pressures and/or high temperatures, whereby the acid gases are stripped from the solvent. Regeneration of the solution leads to near complete desorption of carbon dioxide and hydrogen sulfide.

The processes using ethanolamine and potassium phosphate are now widely used. The ethanolamine process, known as the *Girbotol* process, removes acid gases (hydrogen sulfide and carbon dioxide) from liquid hydrocarbons as well as from natural and from refinery gases. The Girbotol process uses an aqueous solution of ethanolamine ( $\text{H}_2\text{NCH}_2\text{CH}_2\text{OH}$ ) that reacts with hydrogen sulfide at low temperatures and releases hydrogen sulfide at high temperatures. The ethanolamine solution fills a tower called an absorber through which the sour gas is bubbled. Purified gas leaves the top of the tower, and the ethanolamine solution leaves the bottom of the tower with the absorbed acid gases. The ethanolamine solution enters a reactivator tower where heat drives the acid gases from the solution. Ethanolamine solution, restored to its original condition, leaves the bottom of the reactivator tower to go to the top of the absorber tower, and acid gases are released from the top of the reactivator.

The chemistry can be represented by simple equations for low partial pressures of the acid gases:

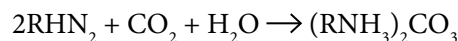
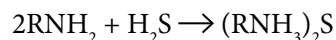

At high acid gas partial pressure, the reactions will lead to the formation of other products:

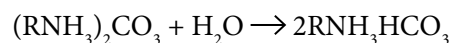
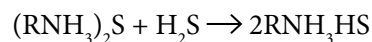

The reaction is extremely fast and the absorption of hydrogen sulfide is only limited by mass transfer; this is not the case for carbon dioxide.

**Table** Olamines used for gas processing.

Olamine	Formula	Derived name	Molecular weight	Specific gravity	Melting point, C	Boiling point, C	Flash point, C	Relative capacity %
Ethanolamine (monoethanolamine)	$\text{HOC}_2\text{H}_4\text{NH}_2$	MEA	61.08	1.01	10	170	85	100
Diethanolamine	$(\text{HOC}_2\text{H}_4)_2\text{NH}$	DEA	105.14	1.097	27	217	169	58
Triethanolamine	$(\text{HOC}_2\text{H}_4)_3\text{N}$	TEA	148.19	1.124	18	335, d	185	41
Diglycolamine (hydroxyethanolamine)	$\text{H}(\text{OC}_2\text{H}_4)_2\text{NH}_2$	DGA	105.14	1.057	-11	223	127	58
Diisopropanolamine	$(\text{HOC}_3\text{H}_6)_2\text{NH}$	DIPA	133.19	0.99	42	248	127	46
Methyldiethanolamine	$(\text{HOC}_2\text{H}_4)_2\text{NCH}_3$	MDEA	119.17	1.03	-21	247	127	51

d: with decomposition

# Ammonia

Ammonia is a compound of nitrogen and hydrogen (NH<sub>3</sub>). It is colorless with a characteristic pungent smell. It is lighter than air, its density being 0.597 that of air. The liquid boils at -33.35 °C (-27.94 °F), and freezes at -77.7 °C (-107.86 °F) to white crystals.

Ammonia contributes significantly the synthesis of many pharmaceutical products derived from petrochemicals in a refinery. Although common in nature and in wide use, ammonia is both caustic and hazardous in its concentrated form. It is classified as an extremely hazardous substance in the United States as defined in Section 302 of the US Emergency Planning and Community Right-to-Know Act (42 U.S.C. 11002), and is subject to strict reporting requirements by facilities which produce, store, or use it in significant quantities.

**Table** Physical properties of ammonia.

Molecular weight	17.031
Vapour pressure at 21 °C (cylinder pressure)	7.87 bar
Specific volume at 21 °C, 1 atm	1.411 ml/g
Boiling point at 1 atm	-33.35 °C
Triple point at 1 atm	-77.7 °C
Triple point pressure	1.33 mbar
Specific gravity, gas at 0 °C, 1 atm (air = 1)	0.5970

Density, gas at boiling point	0.000 89 g/ml
Density, liquid at boiling point	0.674 g/ml
Critical temperature	132.44 °C
Critical pressure	113 bar
Critical density	0.235 g/ml
Flammable limits in air	15–28% by volume
Latent heat of vaporization at boiling point	327.4 cal/g
Specific heat, liquid at -20 °C	1.126 cal/g K
Specific heat, gas at 25 °C, 1 atm	
C <sub>p</sub>	0.5160 cal/g °C
C <sub>v</sub>	0.4065 cal/g °C
ratio, C <sub>p</sub> /C <sub>v</sub>	1.269
Thermal conductivity, gas at 25°C, 1 atm	5.22 × 10 <sup>-5</sup> cal/s cm <sup>2</sup> °C/cm
Entropy, gas at 25 °C, 1 atm	2.7 cal/g °C
Heat of formation, gas at 25 °C	-648.3 cal/g
Solubility at 0 °C, 1 atm	
in water	42.8% by weight
in methanol, absolute	29.3% by weight
in ethanol, absolute	20.95% by weight
Viscosity, gas at 0 °C, 1 atm	0.009 18 cP
Viscosity, liquid at -33.5 °C	0.266 cP



# Aniline Point

The *aniline point* of a liquid (such as diesel fuel) was originally defined as the *consolute* or *critical solution temperature* of the two liquids, that is, the minimum temperature at which they are miscible in all proportions. The term is now most generally applied to the temperature at which exactly equal parts of the two are miscible. This value is more conveniently measured than the original value and is only a few tenths of a degree lower for most substances. Although it is an arbitrary index (ASTM D611), the aniline point is of considerable value in the characterization of petroleum products. The greater the aniline point, the lower the aromatics in diesel oil. A higher aniline point also indicates a higher proportion of paraffin constituents.

For crude oil or crude oil products of a given type, the aniline point increases slightly with molecular weight; for those of given molecular weight it increases rapidly with increasing paraffinic character. As a consequence, the aniline point was one of the first properties proposed for the group

analysis of petroleum products with respect to the content of aromatic derivatives and naphthene derivative. It is used, alternately, even in one of the more recent methods. The simplicity of the determination makes it attractive for the approximate estimation of aromatic content when that value is important for functional requirements, as in the case of the solvent power of naphtha and the combustion characteristics of gasoline and diesel fuel. The diesel index is directly related to the aniline point by the following equation:

$$\text{Diesel Index} = (\text{Aniline Point, } ^\circ\text{F})(\text{API Gravity})/100.$$

A higher aniline point (and therefore a lower aromatic content) in diesel oil is desirable, in order to prevent auto-ignition in the diesel engine. In cases where the content of aromatic constituents in the diesel fuel is high, *mixed aniline point* can be measured to determine the approximate content of aromatic constituents the diesel.





# Anticline

**An anticline** is an area of the crust of the Earth where folding has made a dome-like shape in the once flat rock layers. Anticlines often provide an environment where natural gas can become trapped beneath the surface of the Earth. An anticline is a fold that is convex up and has its oldest beds at its core (Figure). An anticline has a *crest*, which is the highest point on a given stratum along the top of the fold. A *hinge* in an anticline is the locus of maximum curvature or bending in a given stratum in the fold. An *axis* is an imaginary line connecting the hinges in the different strata in a two-dimensional cross-section through the anticline. Connecting the hinges or points of maximum curvature in the different layers in three dimensions produces an *axial plane* or *axial surface*. In a symmetrical anticline, a surface trace of the axial plane coincides with the crest. With an asymmetrical anticline, the surface trace of the axial plane or axis will be offset from the crest toward the steeper flank of the fold. An *overturned anticline* is an asymmetrical anticline with a flank or limb that has been tilted beyond perpendicular so that the beds in that limb are upside down.

A structure that plunges in all directions to form a circular or elongate structure is a dome, which is generally formed

from one main deformation event, or via diapirism from underlying magmatic intrusions or movement of upwardly mobile, mechanically ductile, material such as rock salt (salt dome) and shale (shale diapir). Briefly, a diapir is a type of geologic intrusion in which a more mobile and relatively ductile deformable material is forced into brittle overlying rocks. Depending on the tectonic environment, a diapir can range from an idealized mushroom-shaped structure in regions with low tectonic stress to a narrow dike of material that moves along tectonically induced fractures in surrounding rock.

An anticline which plunges at both ends is termed a *doubly plunging anticline*, and may be formed from multiple deformations, or superposition of two sets of folds, or be related to the geometry of the underlying detachment fault and the varying amount of displacement along the surface of that detachment fault. The highest point on a doubly plunging anticline (or any geologic structure for that matter) is called the *culmination*.

Other types of reservoir structures include: (1) the fault, (2) the pinch out, (3) the salt dome, and various unconformity structures.

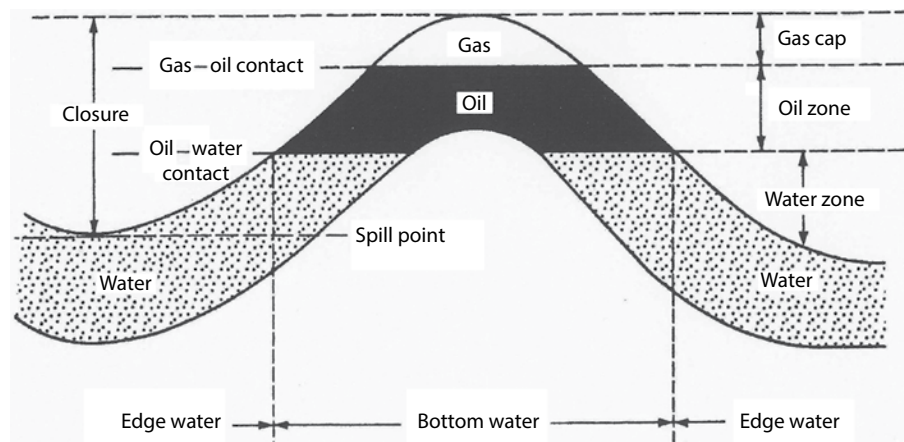

**Figure** An anticlinal trap.



# Antoine Equation

The Antoine equation is a correlation used for describing the relation between vapor pressure and temperature for pure components. The Antoine constants A, B, and C (Table) are component specific constants for the Antoine equation:

$$\log_{10}P = A - (B/C + T)$$

$$T = [B/(A - \log_{10}P)] - C$$

$P$  is the vapor pressure, mm Hg, and  $T$  is the temperature, °C.

**Table** Example of the Antoine constants.

	A	B	C	T <sub>min</sub> , °C	T <sub>max</sub> , °C
Water	8.07131	1730.63	233.426	1	100
Water	8.14019	1810.94	244.485	99	374
Ethanol	8.20417	1642.89	230.3	-57	80
Ethanol	7.68117	1332.04	199.2	77	243



# API Gravity

In the petroleum industry, the use of density or specific gravity has largely been replaced by the API (American Petroleum Institute) gravity (Table 1, Table 2), which is the preferred property (Table 3, Table 4) and is one criterion that is used in setting prices for petroleum. In the United States, the API gravity has been used for the classification of a reservoir and the accompanying tax and royalty consequences. This property was derived from the Baumé scale:

$$\text{Degrees Baumé} = 140/\text{sp gr @ } 60/60 \text{ } ^\circ\text{F} - 130$$

However, a considerable number of hydrometers calibrated according to the Baumé scale were found at an early period to be in error by a consistent amount, and this led to the adoption of the equation:

$$\text{Degrees API} = 141.5/\text{sp gr @ } 60/60 \text{ } ^\circ\text{F} - 131.5$$

The API gravity (ASTM D287) of a feedstock is calculated directly from the specific gravity. The API gravity of petroleum usually ranges from about 45.3 API for lighter crude oil to 10 to 20° API for heavy crude oil (Table 3) and does vary with temperature (Table 4). Tar sand bitumen is usually less than 10° API and shows a range of variation. The largest degree of variation is usually due to local conditions that affect material close to the faces, or exposures, occurring in surface oil sand beds. There are also variations in the specific gravity of the bitumen found in deposits that have not been exposed to weathering or other external factors. However, API gravity alone or in combination with other physical properties boiling point is not adequate to the task of classifying petroleum, heavy oil, extra heavy oil, or tar sand bitumen.

The API gravity and sulfur content of crude oil, heavy oil, and tar sand bitumen are determined as part of the feedstock assay to assist the refiner in determining the means by which the feedstock can be refined and the amount of hydrogen needed to remove the sulfur and, therefore the minimum amount of hydrogen needed to convert the feedstock to liquid fuels.

**Table 1** API gravity and specific gravity.

API gravity	Specific gravity	Kilograms per liter	Pounds per gallon
1	1.0679	1.0658	8.8964
1.5	1.0639	1.0618	8.863
2	1.0599	1.0578	8.8298
2.5	1.056	1.0539	8.7968
3	1.052	1.0499	8.7641
3.5	1.0481	1.0461	8.7317
4	1.0443	1.0422	8.6994
4.5	1.0404	1.0384	8.6674
5	1.0366	1.0346	8.6357
5.5	1.0328	1.0308	8.6042
6	1.0291	1.027	8.5729
6.5	1.0254	1.0233	8.5418
7	1.0217	1.0196	8.511
7.5	1.018	1.0159	8.4804
8	1.0143	1.0123	8.45
8.5	1.0107	1.0087	8.4198
9	1.0071	1.0051	8.3898
9.5	1.0035	1.0015	8.3601
10	1	0.998	8.3306
10.5	0.9965	0.9945	8.3012
11	0.993	0.991	8.2721
11.5	0.9895	0.9875	8.2432
12	0.9861	0.9841	8.2144
12.5	0.9826	0.9807	8.1859
13	0.9792	0.9773	8.1576

(Continued)

Table 1 Cont.

API gravity	Specific gravity	Kilograms per liter	Pounds per gallon
13.5	0.9759	0.9739	8.1295
14	0.9725	0.9706	8.1015
14.5	0.9692	0.9672	8.0738
15	0.9659	0.9639	8.0462
15.5	0.9626	0.9607	8.0189
16	0.9593	0.9574	7.9917
16.5	0.9561	0.9542	7.9647
17	0.9529	0.951	7.9379
17.5	0.9497	0.9478	7.9112
18	0.9465	0.9446	7.8848
18.5	0.9433	0.9414	7.8585
19	0.9402	0.9383	7.8324
19.5	0.9371	0.9352	7.8064
20	0.934	0.9321	7.7807
20.5	0.9309	0.9291	7.7551
21	0.9279	0.926	7.7297
21.5	0.9248	0.923	7.7044
22	0.9218	0.92	7.6793
22.5	0.9188	0.917	7.6544
23	0.9159	0.914	7.6296
23.5	0.9129	0.9111	7.605
24	0.91	0.9081	7.5805
24.5	0.9071	0.9052	7.5562
25	0.9042	0.9023	7.5321
25.5	0.9013	0.8995	7.5081
26	0.8984	0.8966	7.4843
26.5	0.8956	0.8938	7.4606
27	0.8927	0.891	7.4371
27.5	0.8899	0.8882	7.4137
28	0.8871	0.8854	7.3904
28.5	0.8844	0.8826	7.3673
29	0.8816	0.8799	7.3444
29.5	0.8789	0.8771	7.3216
30	0.8762	0.8744	7.2989
30.5	0.8735	0.8717	7.2764
31	0.8708	0.869	7.254
31.5	0.8681	0.8664	7.2317
32	0.8654	0.8637	7.2096
32.5	0.8628	0.8611	7.1876

API gravity	Specific gravity	Kilograms per liter	Pounds per gallon
33	0.8602	0.8585	7.1658
33.5	0.8576	0.8559	7.1441
34	0.855	0.8533	7.1225
34.5	0.8524	0.8507	7.101
35	0.8498	0.8482	7.0797
35.5	0.8473	0.8456	7.0585
36	0.8448	0.8431	7.0375
36.5	0.8423	0.8406	7.0165
37	0.8398	0.8381	6.9957
37.5	0.8373	0.8356	6.975
38	0.8348	0.8331	6.9544
38.5	0.8324	0.8307	6.934
39	0.8299	0.8283	6.9136
39.5	0.8275	0.8258	6.8934
40	0.8251	0.8234	6.8733
40.5	0.8227	0.821	6.8533
41	0.8203	0.8186	6.8335
41.5	0.8179	0.8163	6.8137
42	0.8156	0.8139	6.7941
42.5	0.8132	0.8116	6.7746
43	0.8109	0.8093	6.7551
43.5	0.8086	0.807	6.7358
44	0.8063	0.8047	6.7167
44.5	0.804	0.8024	6.6976
45	0.8017	0.8001	6.6786
45.5	0.7994	0.7978	6.6597
46	0.7972	0.7956	6.641
46.5	0.7949	0.7934	6.6223
47	0.7927	0.7911	6.6038
47.5	0.7905	0.7889	6.5853
48	0.7883	0.7867	6.567
48.5	0.7861	0.7845	6.5487
49	0.7839	0.7824	6.5306
49.5	0.7818	0.7802	6.5126
50	0.7796	0.7781	6.4946
50.5	0.7775	0.7759	6.4768
51	0.7753	0.7738	6.459
51.5	0.7732	0.7717	6.4414
52	0.7711	0.7696	6.4238
52.5	0.769	0.7675	6.4064

(Continued)

Table 1 Cont.

API gravity	Specific gravity	Kilograms per liter	Pounds per gallon
53	0.7669	0.7654	6.389
53.5	0.7649	0.7633	6.3717
54	0.7628	0.7613	6.3546
54.5	0.7608	0.7592	6.3375
55	0.7587	0.7572	6.3205
55.5	0.7567	0.7552	6.3036
56	0.7547	0.7532	6.2868
56.5	0.7527	0.7512	6.2701
57	0.7507	0.7492	6.2534
57.5	0.7487	0.7472	6.2369
58	0.7467	0.7452	6.2204
58.5	0.7447	0.7432	6.2041
59	0.7428	0.7413	6.1878
59.5	0.7408	0.7394	6.1716
60	0.7389	0.7374	6.1555
60.5	0.737	0.7355	6.1394
61	0.7351	0.7336	6.1235
61.5	0.7332	0.7317	6.1076
62	0.7313	0.7298	6.0918
62.5	0.7294	0.7279	6.0761
63	0.7275	0.7261	6.0605
63.5	0.7256	0.7242	6.045
64	0.7238	0.7223	6.0295
64.5	0.7219	0.7205	6.0141
65	0.7201	0.7187	5.9988
65.5	0.7183	0.7168	5.9836
66	0.7165	0.715	5.9685
66.5	0.7146	0.7132	5.9534
67	0.7128	0.7114	5.9384
67.5	0.7111	0.7096	5.9235
68	0.7093	0.7079	5.9086
68.5	0.7075	0.7061	5.8939
69	0.7057	0.7043	5.8792
69.5	0.704	0.7026	5.8645

API gravity	Specific gravity	Kilograms per liter	Pounds per gallon
70	0.7022	0.7008	5.85
70.5	0.7005	0.6991	5.8355
71	0.6988	0.6974	5.8211
71.5	0.697	0.6957	5.8068
72	0.6953	0.6939	5.7925
72.5	0.6936	0.6922	5.7783
73	0.6919	0.6905	5.7642
73.5	0.6902	0.6889	5.7501
74	0.6886	0.6872	5.7361
74.5	0.6869	0.6855	5.7222
75	0.6852	0.6839	5.7083

Table API gravity and sulfur content of selected heavy oils.

	API	Sulfur % w/w
Bachaquero	13.0	2.6
Boscan	10.1	5.5
Cold Lake	13.2	4.1
Huntington Beach	19.4	2.0
Kern River	13.3	1.1
Lagunillas	17.0	2.2
Lloydminster	16.0	2.6
Lost Hills	18.4	1.0
Merey	18.0	2.3
Midway Sunset	12.6	1.6
Monterey	12.2	2.3
Morichal	11.7	2.7
Mount Poso	16.0	0.7
Pilon	13.8	1.9
San Ardo	12.2	2.3
Tremblador	19.0	0.8
Tia Juana	12.1	2.7
Wilmington	17.1	1.7
Zuata Sweet	15.7	2.7

**Table 2** API gravity at observed temperature versus API gravity at 60 °F.

Observed temperature (°F)	18.0	19.0	20.0	21.0	22.0	23.0	24.0	25.0	26.0	27.0
70	17.5	18.4	19.4	20.4	21.4	22.4	23.4	24.4	25.4	26.3
75	17.2	18.2	19.1	20.1	21.1	22.1	23.1	24.1	25.0	26.0
80	16.9	17.9	18.9	19.8	20.8	21.8	22.8	23.7	24.7	25.7
85	16.6	17.6	18.6	19.6	20.5	21.5	22.5	23.4	24.4	25.4
90	16.4	17.3	18.3	19.3	20.2	21.2	22.2	23.1	24.1	25.1
95	16.1	17.1	18.0	19.0	20.0	20.9	21.9	22.8	23.8	24.8
100	15.9	16.8	17.8	18.7	19.7	20.6	21.6	22.5	23.5	24.4
105	15.6	16.5	17.5	18.7	19.4	20.3	21.3	22.2	23.2	24.1
110	15.3	16.3	17.2	18.2	19.1	20.1	21.0	21.9	22.9	23.8
115	15.1	16.0	17.0	17.9	18.8	19.8	20.7	21.6	22.6	23.5
120	14.8	15.8	16.7	17.6	18.6	19.5	20.4	21.3	22.3	23.2
125	14.6	15.5	16.4	17.4	18.3	19.2	20.1	21.1	22.0	22.9
130	14.3	15.2	16.2	17.4	18.0	18.9	19.9	20.8	21.7	22.6
135	14.1	15.0	15.9	16.8	17.7	18.7	19.6	20.5	21.4	22.6
140	13.8	14.7	15.6	16.6	17.5	18.4	19.3	20.2	21.1	22.0

**Table 3** Selected crude oils showing the differences in API gravity and sulfur content within a country.

Country	Crude oil	API	Sulfur % w/w
Abu Dhabi (UAE)	Abu Al Bu Khoosh	31.6	2.00
Abu Dhabi (UAE)	Murban	40.5	0.78
Angola	Cabinda	31.7	0.17
Angola	Palanca	40.1	0.11
Australia	Barrow Island	37.3	0.05
Australia	Griffin	55.0	0.03
Brazil	Garoupa	30.0	0.68
Brazil	Sergipano Platforma	38.4	0.19
Brunei	Champion Export	23.9	0.12
Brunei	Seria	40.5	0.06
Cameroon	Lokele	20.7	0.46
Cameroon	Kole Marine	32.6	0.33
Canada (Alberta)	Wainwright-Kinsella	23.1	2.58
Canada (Alberta)	Rainbow	40.7	0.50
China	Shengli	24.2	1.00
China	Nanghai Light	40.6	0.06
Dubai (UAE)	Fateh	31.1	2.00
Dubai (UAE)	Margham Light	50.3	0.04
Egypt	Ras Gharib	21.5	3.64
Egypt	Gulf of Suez	31.9	1.52
Gabon	Gamba	31.4	0.09
Gabon	Rabi-Kounga	33.5	0.07

(Continued)



Table 3 Cont.

Country	Crude oil	API	Sulfur % w/w
Indonesia	Bima	21.1	0.25
Indonesia	Kakap	51.5	0.05
Iran	Aboozar (Ardeshir)	26.9	2.48
Iran	Rostam	35.9	1.55
Iraq	Basrah Heavy	24.7	3.50
Iraq	Basrah Light	33.7	1.95
Libya	Buri	26.2	1.76
Libya	Bu Attifel	43.3	0.04
Malaysia	Bintulu	28.1	0.08
Malaysia	Dulang	39.0	0.12
Mexico	Maya	22.2	3.30
Mexico	Olmeca	39.8	0.80
Nigeria	Bonny Medium	25.2	0.23
Nigeria	Brass River	42.8	0.06
North Sea (Norway)	Emerald	22.0	0.75
North Sea (UK)	Innes	45.7	0.13
Qatar	Qatar Marine	36.0	1.42
Qatar	Dukhan (Qatar Land)	40.9	1.27
Saudi Arabia	Arab Heavy (Safaniya)	27.4	2.80
Saudi Arabia	Arab Extra Light (Berri)	37.2	1.15
USA (California)	Huntington Beach	20.7	1.38
USA (Michigan)	Lakehead Sweet	47.0	0.31
Venezuela	Leona	24.4	1.51
Venezuela	Oficina	33.3	0.78

Table 4 API gravity and sulfur content of selected heavy oils and tar sand bitumen.

Country	Crude oil	API	Sulfur % w/w
Canada (Alberta)	Athabasca	8.0	4.8
Canada (Alberta)	Cold Lake	13.2	4.11
Canada (Alberta)	Lloydminster	16.0	2.60
Canada (Alberta)	Wabasca	19.6	3.90
Chad	Bolobo	16.8	0.14
Chad	Kome	18.5	0.20
China	Qinhuangdao	16.0	0.26
China	Zhao Dong	18.4	0.25
Colombia	Castilla	13.3	0.22
Colombia	Chichimene	19.8	1.12
Ecuador	Ecuador Heavy	18.2	2.23
Ecuador	Napo	19.2	1.98
USA (California)	Midway Sunset	11.0	1.55
USA (California)	Wilmington	18.6	1.59
Venezuela	Boscan	10.1	5.50
Venezuela	Tremblador	19.0	0.80



# Aromatic Hydrocarbons

An aromatic hydrocarbon (also called an *arene*) is a hydrocarbon of which the molecular structure incorporates one or more planar sets of six carbon atoms that are connected by delocalized electrons numbering the same as if they consisted of alternating single and double covalent. After benzene, aromatic hydrocarbons can be *polycyclic* (i.e., multiple condensed rings) (Table).

Crude oil is a mixture of compounds and aromatic compounds are common to all petroleum; the difference in extent becomes evident upon examination of a series of petroleum. By far the majority of these aromatics contain paraffinic chains, naphthene rings, and aromatic rings side by side. There is a general increase in the proportion of aromatic hydrocarbons with increasing molecular weight. However, aromatic hydrocarbons without the accompanying naphthene rings or alkyl-substituted derivatives seem to be present in appreciable amounts only in the lower petroleum fractions. Thus, the limitation of instrumentation notwithstanding, it is not surprising that spectrographic identification of such compounds has been concerned with these low-boiling aromatics.

All known aromatics are present in gasoline fractions but the benzene content is usually low compared to the benzene homologues, such as toluene and the xylene isomer. In addition to the 1- and 2-methylnaphthalenes, other simple alkyl naphthalene derivatives have also been isolated from crude

oil. Aromatics without naphthene rings appear to be relatively rare in the heavier fractions of petroleum (e.g., lubricating oils). In the higher molecular weight fractions, the rings are usually condensed together either as pure aromatic systems (Table) or as systems where some of the aromatic rings are partially or fully hydrogenated. Thus components with two aromatic rings are presumed to be naphthalene derivatives and those with three aromatic rings may be phenanthrene derivatives. Currently, and because of the consideration of the natural product origins of petroleum, phenanthrene derivatives are favored over anthracene derivatives.

In the higher boiling point petroleum fractions, many polycyclic structures occur in naphthene-aromatic systems. The naphthene-aromatic hydrocarbons, together with the naphthenic hydrocarbon series, form the major content of higher boiling point petroleum fractions. Usually the different naphthene-aromatic components are classified according to the number of aromatic rings in their molecules. The first to be distinguished is the series with an equal number of aromatic and naphthenic rings. The first members of the bicyclic series  $C_9$  to  $C_{11}$  are the simplest, such as the 1-methyl-, 2-methyl-, and 4-methylindanes and 2-methyl- and 7-methyl-tetralin. Tetralin and methyl-, dimethyl-, methyl ethyl-, and tetramethyl tetralin have been found in several crude oils, particularly in the heavier, naphthenic, crude oils.

**Table** Examples of polycyclic aromatic systems\*.

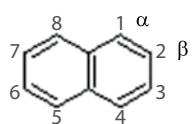

**Naphthalene**  
C<sub>10</sub>H<sub>8</sub>  
m.p. 81 °C

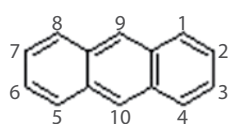

**Anthracene**  
C<sub>14</sub>H<sub>10</sub>  
m.p. 217 °C

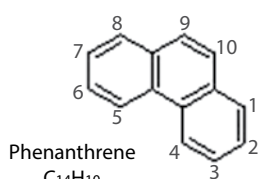

**Phenanthrene**  
C<sub>14</sub>H<sub>10</sub>  
m.p. 100 °C

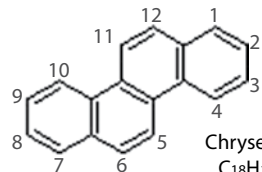

**Chrysene**  
C<sub>18</sub>H<sub>12</sub>  
m.p. 253 °C

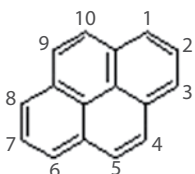

**Pyrene**  
C<sub>16</sub>H<sub>10</sub>  
m.p. 150 °C

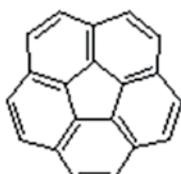

**Corannulene**  
C<sub>20</sub>H<sub>10</sub>  
m.p. 268 °C

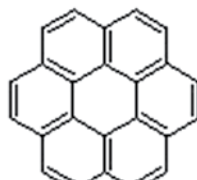

**Coronene**  
C<sub>24</sub>H<sub>12</sub>  
m.p. 442 °C

\*Also referred to as polynuclear aromatics (PNAs) and polyaromatic hydrocarbons (PAHs).

# Asphalt Manufacture

The production of asphalt is dictated by performance specifications and not by chemical composition. To meet the necessary performance specifications, the asphalt is produced from a petroleum residuum or mixed residua and then may be air-blown or further processed by solvent precipitation or propane deasphalting to produce the desired product (Figure). Additionally, the products of other refining processes may be blended with the asphalt to achieve the desired performance specifications. Therefore, the exact chemical composition of asphalt is dependent on the chemical complexity of the original crude petroleum and the manufacturing process.

The manufacturing process can cause significant changes to the physical properties of asphalt but the chemical nature of the asphalt changes to the extent that additional oxygen functional groups are introduced into the constituents of the asphalt. The so-called polymerization of the constituents is considered unlikely and this theory was based on the increased molecular weight of the oxidized product without the investigators realizing that additional oxygen functions can increase the extent of the intermolecular interactions of the constituents. However, air blowing can also, but not always, decrease saturation and increase cross-linking within and between different molecular constituents of asphalt molecules. In this sense, the use of the word *polymerization* to describe the chemistry of the air-blowing process is incorrect.

Raising the temperature of the asphalt feedstock either during distillation or during oxygen blowing will increase the likelihood of cracking and cause more volatiles and even higher-boiling components to be formed during the process. Solvent precipitation (usually using propane or butane) removes high-boiling components from vacuum-processed

asphalt, which are then used to make other products. Solvent precipitation results in the production of a hard asphalt that is less resistant to temperature changes and which is often used as blend stock, along with blended with straight-run or vacuum-processed asphalts.

The air-blowing process can be a continuous or batch operation and, since the continuous operation is faster and results in softer asphalt, the continuous process is preferred for processing paving asphalts. The process is exothermic (heat producing) and may cause a series of chemical reactions, such as oxidation, condensation, dehydration, dehydrogenation, and polymerization. These reactions cause the amount of asphaltene constituents (pentane-insoluble or heptane-insoluble constituents) to increase and the amounts of resin constituents (polar aromatic constituents), cycloalkanes, and non-polar aromatic constituents to decrease, while the amounts of aliphatic constituent (oils and waxes) changes very little.

Although no two asphalts are chemically identical and chemical analysis cannot be used to define the exact chemical structure or chemical composition of asphalt, elemental analyses indicate that most asphalts contain 79 to 88% w/w carbon, 7 to 13% w/w hydrogen, trace to 3% w/w nitrogen, trace to 8% w/w sulfur, trace to 8% w/w oxygen, and trace to 2000 ppm w/w metals (nickel, vanadium 0 in some cases the residuum may also contain iron, copper, and calcium, which are often artifacts of the crude oil transportation process. With the exception of oxygen in the asphalt, the other elements are derived from the residuum (or residua) from which the asphalt was produced. While heteroatoms (i.e., nitrogen, oxygen, and sulfur) make up only a minor component of asphalt, the heteroatoms profoundly influence the differences in physical properties of asphalts from different crude sources.

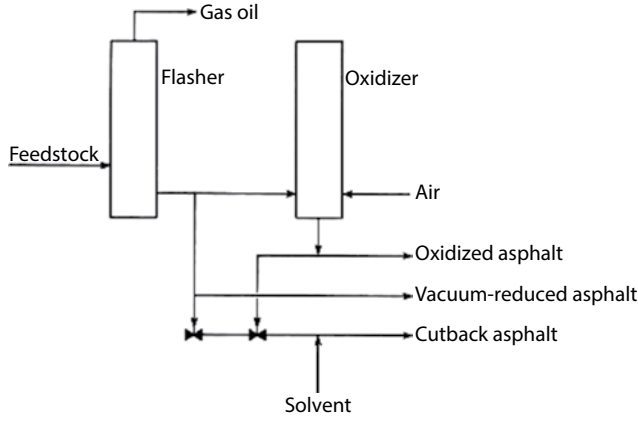

Figure Asphalt manufacture including air blowing.

# Asphaltene Constituents

The *asphaltene fraction* of crude oil, heavy oil, extra heavy oil, or tar sand bitumen is that portion of the oil or bitumen that is precipitated when a large excess (40 volumes) of a low-boiling liquid hydrocarbon (e.g., *n*-pentane or *n*-heptane) is added to the crude oil (1 volume) (Speight, 1994). *n*-Heptane is the preferred hydrocarbon with *n*-pentane still being used although hexane is used on occasion (Table). The asphaltene fraction can be further separated on the basis of polarity (functional groups content) (Figure 1). Feedstock evaluation by separation into various fractions has been used successfully for several decades. The knowledge of the bulk fractions of a refinery feedstock (Figure 2) on a *before recovery* (core sample analysis) and *after recovery* (well fluid analysis) basis, as well as variations over time, has been a valuable aid to recovery process development.

The phase behavior of fluid containing asphaltene constituents is complex. Chemically, asphaltene constituents are difficult to define in general, and the physics and chemistry

underlying the definition of this fraction is not open to debate; the fraction is a solubility fraction and is, in reality, an artifact of the separation method. In fact, asphaltene fractions possessing similar constituents may exhibit different properties in their native fluids and in solvents/non-solvent mixtures. Asphaltene constituents intra-act and interact with one another and with solvent media. Phase behavior and precipitation models must capture the relevant physics and chemistry if derived models are to be truly predictive. But the issue is the use of *average parameters* rather than the recognition the asphaltene fraction is a collection of different molecular types that vary from crude oil to crude oil, because of the complexities of the maturation process, and should be represented as such in any models. In fact, analytical methods such as fractionation and high-performance liquid chromatography (HPLC) have shown conclusively that the asphaltene fraction is a mix of unknown (at best *speculative*) molecular structure.

**Table** ASTM standard methods for asphaltene separation.

Method	Precipitant	Volume precipitant per gm of sample
ASTM D893	<i>n</i> -pentane	10 ml
ASTM D2006	<i>n</i> -pentane	50 ml
ASTM D2007	<i>n</i> -pentane	10 ml
ASTM D3279	<i>n</i> -heptane	100 ml
ASTM D4124	<i>n</i> -heptane	100 ml

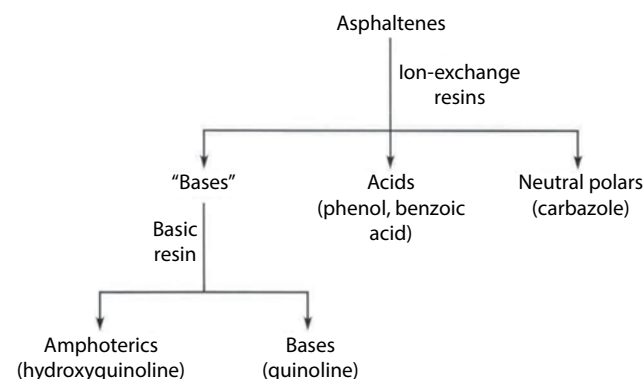

**Figure 1** Separation of asphaltene constituents based on functionality (polarity).

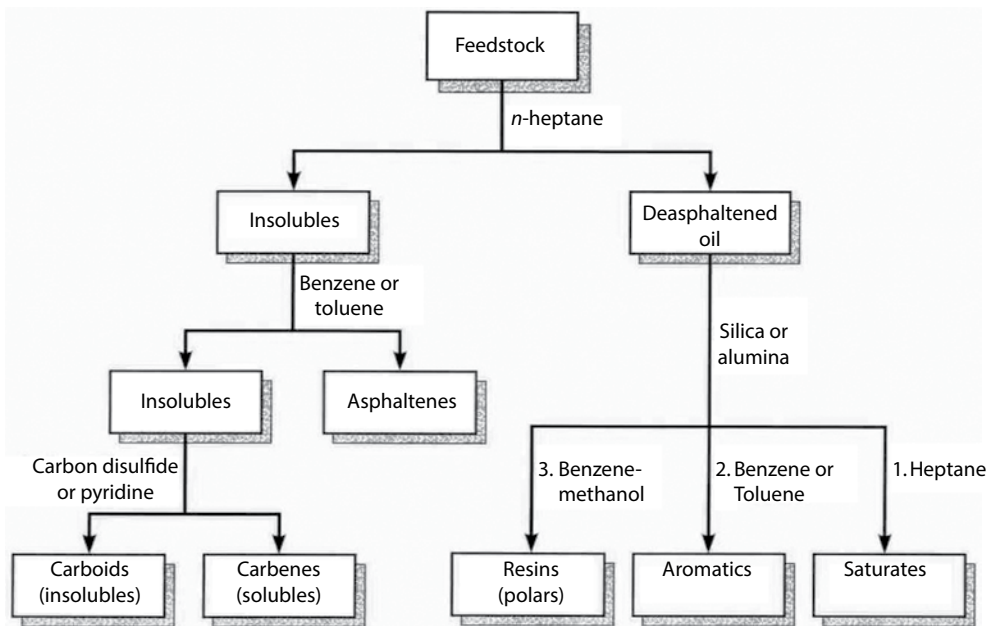

Figure 2 General fractionation Scheme for Refinery Feedstocks.



# Associated Natural Gas

Almost all oil reservoirs except those classified as extra heavy reservoirs or tar sand deposits will produce natural gas at the surface. Crude oil is not transported in a commercial pipeline or a tanker with gas still in the solution. The term *stock tank oil*,

which is used both as a measure for oil well performance and in commercial pricing of oil, means that all associated gas has been stripped from the liquid at one atmosphere pressure. The gas thus liberated from the crude oil is known as *associated gas*.



# Atmospheric Equivalent Boiling Point

The atmospheric equivalent boiling point is the boiling point at which a petroleum fraction would boil under atmospheric pressure if it was stable and would not decompose. This provides a common basis for the categorization and direct comparison of petroleum components across the entire volatility range accessible by atmospheric and vacuum distillation.

Distillation at lower pressure allows high-boiling petroleum fractions to distill at lower temperatures, thereby foregoing the potential of thermal decomposition if attempts were made to distill the fraction at the higher temperatures required at atmospheric pressure. This allows the collection of distillates with an atmospheric equivalent temperature cut point of as high as 560 °C (1050 °F). The actual observed boiling points during this distillation are, of course, much lower. Despite the low pressure, the reboiler may have to be heated as high as 370 °C (700 °F) for such high-boiling distillates.

Molecular distillation is a non-equilibrium process and the atmospheric equivalent boiling ranges of the fractions cannot be measured directly. The atmospheric equivalent boiling point (AEBP) concept was developed to compensate for this:

$$\text{mid-AEBP (}^\circ\text{F)} = \{[(M_n - 140)(\text{sp. gr.})^{2.5}/3.40] \times 10^7\}^{1/3}$$

$$\text{mid-AEBP (}^\circ\text{F)} = \{[(M_n - 170)(\text{H/C})^{0.9}/2.67] \times 10^7\}^{1/3}$$

The mid-AEBP is the temperature for the 50% mass point on the distillation curve of the fraction, and  $M_n$  is the molecular weight. Either the specific gravity (sp. gr.) or atomic hydrogen/carbon (H/C) ratio, which can be readily measured in the fractions, can also be used.

Using the mid-AEBP concept, even fractions of the non-distillable residue can be included in the boiling range curves and relationships such as the variation of sulfur and nitrogen contents can be derived as a function of the AEBP. Typically, as the mid-AEBP increases, the sulfur and nitrogen concentrations of the fraction generally also increase. Also, the highest concentrations of both sulfur and nitrogen appear in the non-distillable fractions. This behavior follows the heteroatom behavior observed for refinery distillation cuts. Thus, the higher the boiling range of the fraction, the higher the heteroatom concentration. This also establishes that the heteroatom concentration continues to increase as the volatility of the compounds decreases, which was not known previously for the 540 °C+ (1000 °F+) residuum.



# Auto-ignition Temperature

The auto-ignition temperature (sometimes referred to as the *ignition temperature*) is the minimum temperature at which the material will ignite without a spark or flame being

present. The method of measurement is given by ASTM E659 (Standard Test Method for Autoignition Temperature of Liquid Chemicals).



# Barrel

The standard oil barrel of 42 US gallons is used in the United States as a measure of crude oil and other petroleum products. The 42-US-gallon size of barrel as a unit of measure is largely confined to the American oil industry, since other sizes of barrel were used by other industries in the United States, and nearly all other countries use the metric system. Many oil-producing countries that did not have the technical expertise to develop their own domestic oil industry standards use the American oil barrel because their oil industries were founded by US oil companies.

Outside of the United States, oil is commonly measured in cubic meters (m<sup>3</sup>) or in tonnes (1 tonne = 2,204.6 lbs), with tonnes more often being used by European oil companies. International companies listed on American stock exchanges tend to convert their oil production volumes to barrels for global reporting purposes, and those listed on European exchanges tend to convert their production to tonnes.

The wooden oil barrel of the late 1800s is different from the modern-day 55-gallon steel drum (known as the 44-gallon drum in Britain and the 200-liter drum in Australia). The

42-US-gallon oil barrel is a unit of measure, and is no longer used to transport crude oil – most petroleum is moved in pipelines or oil tankers.

The barrel of oil equivalent (BOE) is a unit of energy based on the approximate energy released by burning one barrel (42 US gallons) of crude oil. The barrel of oil equivalent is used by oil and gas companies in their annual financial statements as a way of combining oil reserves and natural gas reserves as well as production into a single measure. The Internal Revenue Service of the United States defines the barrel of oil equivalent as equal to  $5.8 \times 10^6$  Btu. A barrel of oil equivalent is approximately 6,000 cubic feet of typical natural gas. Other conversion data are the BBOe, (also BBOE), or billion barrel of oil equivalent, representing 10<sup>9</sup> (US billion) barrels of oil, used to measure petroleum reserves, and million barrels per day, MMbd (or MMBD), used to measure daily production and consumption. Also used is the Mtoe (not *middle toe* but *millions of tonnes of oil equivalent*), a metric measurement equivalent to approximately 0.006841 billion barrels of oil equivalent.

Table Conversion factors for barrels to other units.

Crude oil	To convert to:				
	Tonnes (metric)	Liters × 1000	Barrels	US gallons	Tonnes/year
From	-----Multiply by-----				
Tonnes (metric)	1	1.165	7.33	307.86	–
Liters × 1000	0.8581	1	6.2898	264.17	–
Barrels	0.1364	0.159	1	42	–
US gallons	0.00325	0.0038	0.0238	1	–
Barrels/day	–	–	–	–	49.8





# Baumé Gravity

Baumé gravity (reported as degrees Bé, °Bé) is a unit of measurement of specific gravity used in the chemical industry for aqueous reporting the gravity of aqueous caustic soda solutions and aqueous acid solutions.

$$\text{Degrees Baumé} = 140/\text{sp gr @ } 60/60 \text{ } ^\circ\text{F} - 130$$

However, two arbitrary scales are employed: (1) a scale for liquids lighter than water and (2) a scale for liquids heavier than water (Table).

**Table** Guide to the use of Baumé Gravity.

<b>For liquids heavier than water:</b>	<b>For liquids lighter than water:</b>
0° Bé is the distance the hydrometer sinks in pure water	0 Bé is the distance the hydrometer sinks in a solution that is 10% w/w sodium chloride (salt, NaCl)
15° Bé is distance the hydrometer sinks in a solution that is 15% w/w sodium chloride (salt, NaCl)	10° Bé is the distance the hydrometer sinks in pure water
To convert from degrees Bé to specific gravity at 60 °F:	To convert from degrees Bé to specific gravity at 60 °F:
specific gravity = $145/(145 - \text{°Bé})$	specific gravity = $140/(130 + \text{°Bé})$



# Benchmark Crude Oil

A *benchmark* crude oil is, in the current context, a standard against which the properties of crude oil can be measured or compared. When evaluating the price of any crude oil it is important to compare the crude oil against an appropriate benchmark crude oil.

The price of petroleum means the spot price of either West Texas Intermediate crude oil as traded on the New York Mercantile Exchange (NYMEX) for delivery in Cushing, Oklahoma, or of Brent crude as traded on the Intercontinental Exchange (ICE, into which the International Petroleum Exchange has been incorporated) for delivery at Sullom Voe. The price of a barrel of oil is highly dependent on both its grade, determined by factors such as its specific gravity or API gravity and sulfur content, as well as location. The vast majority of oil is not traded on an exchange but on an over-the-counter basis, typically with reference to a marker crude oil grade that is typically quoted via pricing. Other important benchmark crude oils include Dubai, Tapis, and the OPEC basket.

For the purposes of pricing, crude oil is generally classified based on the API gravity and sulfur content. For example, *light crude oil* has low density, low viscosity (there are no exact numbers assigned to this, because the classification is more practical than theoretical), and low sulfur content, making it easier to transport and refine and, therefore, more expensive to purchase. *Sweet crude oil* has a sulfur content less than 0.5% by weight and is usually (but not always) *light crude oil*, making it much easier to refine in a way that would meet environmental standards in developed countries – and making it more expensive.

A light crude oil is generally one with an API gravity of less than about 40. Brent crude oil has an API gravity of 38 to 39. Sweet crude is preferable to sour crude oil because it is also (like light crude) more suited to the production of the most valuable refined products. On the other hand, *heavy crude oil* has high density, high viscosity, and high sulfur content, making it more difficult to transport and

refine and cheaper to purchase. *Sour crude oil* has a sulfur content above 0.5% by weight and is usually *heavy crude oil*, making it cheaper to purchase but more expensive to refine. Heavy crude oil will typically have an API gravity of 20 or less – the higher the API gravity, the lower the density. Heavy crude oil is harder to handle (it is too thick to pump easily through pipelines unless diluted with light crude) and is more expensive to refine to produce the most valuable petroleum products such as gasoline, diesel and aviation fuel.

Approximately 160 different types of crude oils that are traded around the world; the four primary benchmark crude oils which are priced internationally are: (1) Brent blend crude oil, (2) West Texas Intermediate (WTI) crude oil, (3) Dubai crude oil, and (4) the OPEC basket crude oil.

The Brent crude oil blend is based on the prices of Brent crude, which is a light, sweet crude oil and is actually a combination of crude oil from 15 different oil fields in the Brent and Ninian systems located in the North Sea. The API gravity is 38.3° (making it a “light” crude oil, but not quite as “light” as West Texas Intermediate crude oil), while it contains about 0.37% by weight sulfur (making it a sweet crude oil, but again slightly less sweet than West Texas Intermediate crude oil). The Brent blend is ideal for making gasoline and middle distillates, both of which are consumed in large quantities in Northwest Europe, where Brent blend crude oil is typically refined. However, if the arbitrage between Brent and other crude oils, including WTI, is favorable for export, Brent has been known to be refined in the United States (typically the East Coast or the Gulf Coast) or the Mediterranean region. Brent blend, like West Texas Intermediate crude oil, production is also on the decline, but it remains the major benchmark for other crude oils in Europe or Africa. For example, prices for other crude oils in these two continents are often priced as a differential to Brent, i.e., Brent minus \$0.50. Brent blend is generally priced at about a \$4 per-barrel premium to the OPEC basket price or about a \$1 to \$2 per-barrel

discount to West Texas Intermediate crude oil, although on a daily basis the pricing relationships can vary greatly.

The West Texas intermediate crude oil is the benchmark for oil prices in the United States based on light, low sulfur (0.24% by weight) West Texas Intermediate crude oil, which remains the benchmark for oil prices in the United States despite the fact that production of this crude oil has been decreasing over the past two decades. West Texas Intermediate crude oil is of very high quality and is excellent for refining a larger portion of gasoline. Its API gravity is 39.6 degrees (making it a “light” crude oil), and it contains only about 0.24% of sulfur (making a “sweet” crude oil). This combination of characteristics, combined with its location, makes it an ideal crude oil to be refined in the United States, the largest gasoline-consuming country in the world. Most West Texas Intermediate crude oil is refined in the Midwest region of the United States, with some more refined within the Gulf Coast region. Although the production of WTI crude oil is on the decline, it still is the major benchmark of crude oil in the Americas. West Texas Intermediate crude oil generally priced at about a \$5 to \$6 per-barrel premium to the OPEC basket price and

about \$1 to \$2 per-barrel premium to Brent, although on a daily basis the pricing relationships between these crude oils can vary greatly.

Dubai crude oil is a benchmark for Persian Gulf crudes, and is light yet sour (high sulfur) crude oil. The OPEC crude oil basket blend is OPEC’s benchmark, a weighted average of oil prices collected from various oil-producing countries. This average is determined according to the production and exports of each country and is used as a reference point by OPEC to monitor worldwide oil market conditions. As of June 15, 2005, the basket was changed to represent the oil produced by OPEC members and is made up of 13 different regional oils, namely: Saharan Blend (Algeria), Girassol (Angola), Oriente (Ecuador), Minas (Indonesia), Iranian Heavy (Iran), Basra Light (Iraq), Export Crude (Kuwait), Es Sider (Libya), Bonny Light (Nigeria), Marine Crude (Qatar), Arab Light (Saudi Arabia), the Murban (UAE), and BCF 17 (Venezuela). Because WTI crude oil is a very light, sweet (low sulfur content) crude, it is generally more expensive than the OPEC basket blend. Brent is also lighter, sweeter, and more expensive than the OPEC basket, although less so than West Texas Intermediate crude oil.

# Bernoulli's Principle

Bernoulli's principle states that an increase in the speed of a fluid occurs simultaneously with a decrease in pressure or a decrease in the potential energy of the fluid. The principle can be applied to various types of fluid flow, resulting in various forms of Bernoulli's equation; there are different forms of Bernoulli's equation for different types of flow.

In most flows of liquids and of gases, the density of a fluid parcel can be considered to be constant, regardless of pressure variations in the flow. Therefore, the fluid can be considered to be incompressible and these flows are called incompressible flows. Bernoulli performed his experiments on liquids, so his equation in its original form is valid only for incompressible flow. A common form of Bernoulli's equation, valid at any arbitrary point along a streamline, is:

$$v^2/2 + gz + p/\rho = \text{constant}$$

In this equation,  $v$  is the fluid flow speed at a point on a streamline,  $g$  is the acceleration due to gravity,  $z$  is the elevation of the point above a reference plane, with the positive  $z$ -direction pointing upward – so in the direction opposite

to the gravitational acceleration,  $p$  is the pressure at the chosen point, and  $\rho$  is the density of the fluid at all points in the fluid. The constant on the right-hand side of the equation depends only on the streamline chosen, whereas  $v$ ,  $z$ , and  $p$  depend on the particular point on that streamline.

In many applications of Bernoulli's equation, the change in the  $\rho g z$  term along the streamline is so small compared with the other terms that it can be ignored. This allows the above equation to be presented in the following simplified form in which  $p_0$  is the total pressure and  $q$  is the dynamic pressure. Thus:

$$p + q = p_0$$

Or, static pressure + dynamic pressure = total pressure.

Every point in a steadily flowing fluid, regardless of the fluid speed at that point, has its own unique static pressure,  $p$ , and dynamic pressure,  $q$ . Their sum ( $p + q$ ) is defined to be the total pressure,  $p_0$ . The significance of Bernoulli's principle can now be summarized as *total pressure is constant along a streamline*.



# Biomass and Biofuels

Biomass, any material produced in nature by biological means, is a renewable resource that has received increased interest as a fuel source to expand the development of domestic and renewable energy sources and reduce the environmental impacts of energy production. The most important biomass energy sources are wood and wood wastes, agricultural crops and their waste byproducts, municipal solid waste (MSW), animal wastes, waste from food processing, and aquatic plants and algae.

*Biofuel* is any fuel that is developed from naturally occurring organic material (excluding petroleum and the other fossil fuels) and represent a renewable and sustainable source of energy used to create electricity or other forms of power. Some examples of materials that make up biomass fuels are: (1) scrap lumber, (2) forest debris, (3) certain crops, (4) manure; and (5) various types of waste residues (Figure). Thus, biomass is a renewable source of fuel to produce energy because waste residues will always exist and, properly managed, forests will always have more trees as

well as crops and the residual biological matter from those crops. *Biofuel* has also been defined as any fuel with an 80% minimum content by volume of materials derived from living organisms harvested within the ten years preceding its manufacture (Tables 1–12).

In the refinery of the future, it is entirely possible that a petroleum refinery and a biorefinery could be amalgamated to produce the necessary fuels. In a manner similar to the petroleum refinery, a biorefinery would integrate a variety of conversion processes to produce multiple product streams such as motor fuels and other chemicals from biomass. In short, a biorefinery would combine the essential technologies to transform biological raw materials into a range of industrially useful intermediates. However, the type of biorefinery would have to be differentiated by the character of the feedstock. For example, the *crop biorefinery* would use raw materials such as cereals or maize and the *lignocellulose biorefinery* would use raw material with high cellulose content, such as straw, wood and paper waste.

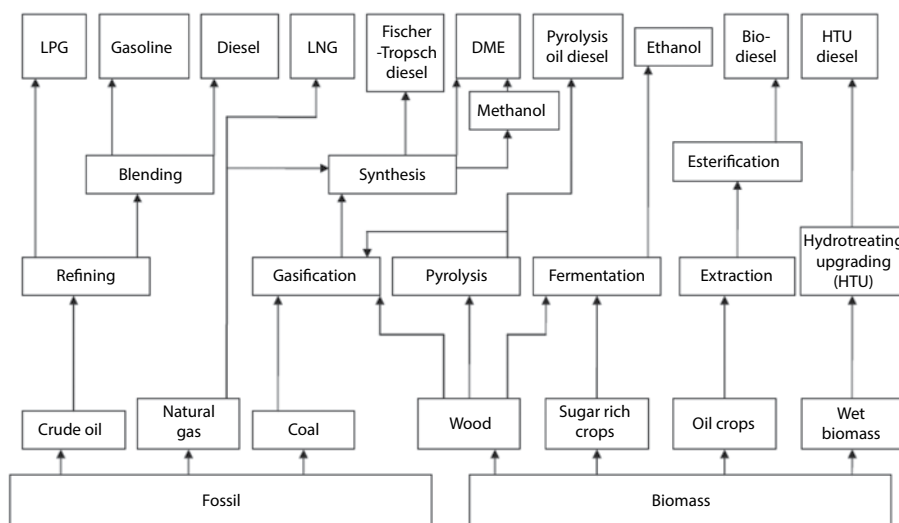

Figure Fuels from fossil fuels and biomass.

**Table 1** Composition of biogas from different sources.

Component	Agricultural biogas	Sewage gas	Landfill gas
Methane	55–75%	55–65%	40–45%
Carbon dioxide	25–45%	30–40%	35–50%
Nitrogen	0–10%	0–10%	0–20%
Hydrogen sulfide	0–1.5%	≤200 ppm	Approx. 200 ppm
Water	Saturated	Saturated	Saturated
Halogens	Trace amount	Up to 4 ppm	Dependent on the landfill
Higher hydrocarbons	Trace amount	Trace amount	Up to 200 ppm

**Table 2** Elemental composition (with ash content) of bio-fuels (% w/w, dry basis).

Fuel	C	H	O	N	S	Ash	
Birch wood	48.8	6.0	44.2	0.5	0.01	0.5	20.0
Pine wood	49.3	6.0	44.2	0.5	0.01	0.5	20.1
Bark	47.2	5.6	46.9	0.3	0.07	3.9	20.9
Wheat straw	49.6	6.2	43.6	0.6	n.a	4.7	18.6
Miscanthus	49.5	6.2	43.7	0.6	n.a	3.3	18.5
Sugar cane	49.5	6.2	43.8	0.5	n.a	3.7	18.5
Reed grass	49.4	6.3	42.7	1.6	n.a	8.8	18.8
Peat	53.1	5.5	38.1	1.3	0.2	5.6	20.5
Coal	80.4	5.0	6.7	1.3	0.53	7.0	30.4

**Table 3** Heating value of selected fuels.

Fuel	Btu/lb
Natural gas	23,000
Gasoline	20,000
Crude oil	18,000
Heavy oil	16,000
Coal (anthracite)	14,000
Coal (bituminous)	11,000
Wood (farmed trees, dry)	8,400
Coal (lignite)	8,000
Biomass (herbaceous, dry)	7,400
Biomass (corn stover, dry)	7,000
Wood (forest residue, dry)	6,600
Bagasse (sugar cane)	6,500
Wood	6,000

**Table 4** Typical plants used as a source of energy.

Biomass	Plant species	Predominant form of energy use
Wood	Various types (bushes, shrubs, trees) depending upon the location	Firewood (ca. 50% w/w of harvest)
Starch	Cereals, millets, root and tuber crops, e.g., potato	Bioethanol manufacture
Sugar	Sugarcane, sugar beet	Bioethanol manufacture
Hydro-carbons	Various types depending upon the location	Biodiesel manufacture
Wastes	Crop residues, animal/human refuse, sewage.	Biogas manufacture

**Table 5** Chemical composition of different biomass types (% w/w dry basis).

Type	Cellulose	Hemicellulose	Lignin	Others	Ash
Soft wood	41	24	28	2	0.4
Hard wood	39	35	20	3	0.3
Pine bark	34	16	34	14	2
Straw (wheat)	40	28	17	11	7
Rice husks	30	25	12	18	16
Peat	10	32	44	11	6



**Table 6** Selected properties of common bio-feedstocks and biofuels (c.f., coal and crude oil distillate).

Chemical characteristics					
		Ash % w/w	Sulfur % w/w	Potassium % w/w	Ash melting temperature, °C
Bio-feedstocks	Corn stover	5.6			
	Sweet sorghum	5.5			
	Sugarcane bagasse	0.2–5.5	0.10–0.15	0.73–0.97	
	Sugarcane leaves	7.7			
	Hardwood	0.45	0.009	0.04	900
	Softwood	0.3	0.01		
	Hybrid poplar	0.5–1.5	0.03	0.3	1350
	Bamboo	0.8–2.5	0.03–0.05	0.15–0.50	
	Switchgrass	4.5–5.8	0.12		1016
	Miscanthus	1.5–4.5	0.1	0.37–1.12	1090
Giant cane	5–6	0.07			
Liquid biofuels	Bioethanol		< 0.01		N/A
	Biodiesel	< 0.02	< 0.05	< 0.0001	N/A
Fossil Fuels	Coal - low rank; lignite/ sub-bituminous	5–20	1.0–3.0	0.02–0.3	~1300
	Coal - high rank; bituminous/anthracite	1–10	0.5–1.5	0.06–0.15	~1300
	Crude oil distillate	0.5–1.5	0.2–1.2		N/A

**Table 7** Physical and chemical properties of ethanol, methanol and gasoline.

Property	Methanol CH <sub>3</sub> OH	Ethanol C <sub>2</sub> H <sub>5</sub> OH	Gasoline C <sub>4</sub> -C <sub>12</sub>
Molecular weight (g/mol)	32	46	~114
Specific gravity	0.789 (298 K)	0.788 (298 K)	0.739 (288.5 K)
Vapor density rel. to air	1.10	1.59	3.0 to 4.0
Liquid density (g cm <sup>-3</sup> at 298 K)	0.79	0.79	0.74
Boiling point (K)	338	351	300 to 518
Melting point (K)	175	129	
Vapor pressure@311 K (psia)	3.6	2.5	8–10
Heat of evaporation (Btu/lb)	472	410	135
Heating value (kBTU gal <sup>-1</sup> )			
Lower	58	74	111
Upper	65	85	122
Tank design pressure (psig)	15	15	15
Viscosity (cp)	0.54	1.20	0.56
Flash point (K)	284	287	228
Flammability/explosion limits			
(%) Lower (LFL)	6.7	3.3	1.3
(%) Upper (UFL)	36	19	7.6
Auto ignition temperature (K)	733	636	523–733
Solubility in H <sub>2</sub> O (%)	Miscible (100%)	Miscible (100%)	Negligible (~ 0.01)
Azeotrope with H <sub>2</sub> O	None	95% EtOH	Immiscible
Peak flame temperature (K)	2143	2193	2303
Minimum ignition energy in air (mJ)	0.14		0.23

**Table 8** Specifications of diesel and biodiesel fuels.

Property	Diesel	Biodiesel
Standard	ASTM D975	ASTM D6751
Composition	C <sub>10</sub> -C <sub>22</sub> hydrocarbons	FAME <sup>1</sup> (C <sub>12</sub> -C <sub>22</sub> )
Specific gravity (g/mL)	0.85	0.88
Flash point (K)	333-353	373-443
Cloud point (K)	258 to 278	270 to 285
Pour point (K)	238 to 258	258 to 289
Water, % v/v	0.05	0.05
Carbon, % w/w	87	77
Hydrogen, % w/w	13	12
Oxygen, % w/w	0	11
Sulfur, % w/w	0.05	0.05
Cetane number	40-55	48-60

<sup>1</sup>FAME: fatty acid methyl esters.**Table 9** Typical properties of bio-oil from wood pyrolysis and no. 2 diesel fuel.

	Bio-oil	No 2. Diesel fuel
Moisture content	15-30	n.a.
pH	2.5	1
Specific gravity	1.20	0.847
Elemental analysis		
C (wt%)	55-58	86
H	5.5-7.0	11.1
O	35-40	0
N	0-0.2	1
S	n.d.	0.8
HHV (MJ/kg) as produces	16-19	44.7
Viscosity	40-100 cp (315 K, 25% water)	<2.39 (325 K)

**Table 12** Moisture, ash, heat content, and chemical composition of selected biomass fuels.

Fuel type	Clean wood <sup>a</sup>	Verge grass	Organic domestic waste	Demolition wood	Sludge
Moisture content, % w/w wet fuel	50	60	54	20	20 <sup>b</sup>
Ash content, % w/w dry fuel <sup>c</sup>	1.3	8.4	18.9	0.9	37.5
LHV (as received), MJ/kg	7.7	5.4	6.4	13.9	8.8
HHV (as received), MJ/kg	9.6	7.4	8.3	15.4	9.9
Composition, % w/w (maf <sup>*</sup> )					
C	49.10	48.70	51.90	48.40	52.50
H	6.00	6.40	6.70	5.20	7.20
O	44.30	42.50	38.70	45.20	30.30
N	0.48	1.90	2.20	0.15	6.99
S	0.01	0.14	0.50	0.03	2.74
Cl	0.10	0.39	0.3	0.08	0.19

<sup>\*</sup>Moisture ash free.**Table 10** Properties of vegetable oil biodiesel and diesel fuel.

Vegetable oil	Cetane number	Flash point	Cloud point °C	Density	Pour point °C
Peanut	64	176	5	0.883	-
Soybean	45	178	1	0.885	-7
Sunflower	63	127	4	0.875	-
Palm	62	164	13	0.880	-
Babassu	49	183	1	0.860	-
Tallow	-	96	12		9
Diesel	50	76	-	0.855	-16

**Table 11** Properties of Fischer-Tropsch diesel fuel and no.2 diesel fuel.

Property	FT diesel fuel	No. 2 diesel fuel
Density, g/cm <sup>3</sup>	0.78	0.83
Aromatics, %	0-0.1	
Cetane number	76-80	8-16
Sulfur content, ppm	0-0.1	40-44
		25-125

# Bitumen

The term *bitumen* (also, on occasion, referred to as *native asphalt*, and *extra heavy oil*) includes a wide variety of reddish brown to black materials of semisolid, viscous to brittle character that can exist in nature with no mineral impurity or with mineral matter contents that exceed 50% w/w. Bitumen is frequently found filling pores and crevices of sandstone, limestone, or argillaceous sediments, in which case the organic and associated mineral matrix is known as *rock asphalt*. Bitumen is a naturally occurring material that is found in deposits where the permeability is low and passage of fluids through the deposit can only be achieved by prior application of fracturing techniques. Tar sand bitumen is a high-boiling material with little, if any, material boiling below 350 °C (660 °F) and the boiling range approximates the boiling range of an atmospheric residuum.

In order to define bitumen, heavy oil, and conventional petroleum, the use of a single physical parameter such as viscosity is not sufficient. Physical properties such as API gravity, elemental analysis, and composition fall short of giving an adequate definition. It is the properties of the bulk deposit and, most of all, the necessary recovery methods that form the basis of the definition of these materials. Only then is it possible to classify petroleum, heavy oil, and tar sand bitumen. For example, *tar sands* have been defined in the United States (FE-76-4) as:

*...the several rock types that contain an extremely viscous hydrocarbon which is not recoverable in its natural state by conventional oil well production methods including currently used enhanced recovery techniques. The hydrocarbon-bearing rocks are variously known as bitumen-rocks oil, impregnated rocks, oil sands, and rock asphalt.*

The recovery of the bitumen depends to a large degree on the composition and construction of the

sands. Generally, the bitumen found in tar sand deposits is an extremely viscous material that is *immobile under reservoir conditions* and cannot be recovered through a well by the application of secondary or enhanced recovery techniques.

The expression *tar sand* is commonly used in the petroleum industry to describe sandstone reservoirs that are impregnated with a heavy, viscous black crude oil that cannot be retrieved through a well by conventional production techniques (FE-76-4, above). However, the term *tar sand* is actually a misnomer; more correctly, the name *tar* is usually applied to the heavy product remaining after the destructive distillation of coal or other organic matter. Thus, alternative names, such as *bituminous sand* or *oil sand*, are gradually finding usage, with the former name (bituminous sands) more technically correct. The term *oil sand* is also used in the same way as the term *tar sand*, and these terms are often used interchangeably.

The term *bitumen*, as also used in oil shale technology to describe the lower molecular weight soluble, organic component of oil shale. The amount of bitumen is low, usually on the order of 0.5 to 5% w/w of the total weight of the oil shale. Thus, oil shale organic matter can be characterized as two materials, kerogen and bitumen, the latter being benzene soluble. Bitumen is also the product produced by the high molecular weight material thermal decomposition of kerogen. The yield of bitumen (extractable material) increases with (1) increasing extraction temperature, (2) with increasing polarity of the extraction solvent, and (3) with the chemical reactivity of the solvent. Moreover, bitumen is generally richer in hydrogen (H/C may be on the order of approximately 1.6 with a molecular weight of approximately 1200) and nitrogen while it is lower in the proportion of aromatic constituents (and consequently richer in aliphatic constituents than the corresponding kerogen).



## Bituminous Rock and Bituminous Sand

*Bituminous rock* and *bituminous sand* are those formations in which the bituminous material is found as a filling in veins and fissures in fractured rocks or impregnating relatively shallow sand, sandstone, and limestone strata. The deposits contain as much as 20% bituminous material, and if the organic material in the rock matrix is bitumen, it is usual (although chemically incorrect) to refer to the deposit as *rock asphalt* to distinguish it from bitumen that is relatively mineral free. Various reliable test methods are available for determining the bitumen content of various mixtures with inorganic materials. If the

material is of the asphaltite-type or asphaltoid-type, the corresponding terms should be used: rock asphaltite or rock asphaltoid.

Bituminous rocks generally have a coarse, porous structure, with the bituminous material in the voids. A much more common situation is that in which the organic material is present as an inherent part of the rock composition insofar as it is a diagenetic residue of the organic material detritus that was deposited with the sediment. The organic components of such rocks are usually refractory and are only slightly affected by most organic solvents.



# Black Acids

The term *black acids* is a term of convenience that refers to a mixture of the sulfonates found in acid sludge which are formed during treatment of petroleum products with sulfuric acid. Black acids are soluble in water but insoluble in naphtha, benzene, carbon tetrachloride, and 30% sulfuric acid. In the dry, oil-free state, the sodium soaps are black powders.

Sulfuric acid ( $\text{H}_2\text{SO}_4$ ) treatment has the longest history of any petroleum-treating method. Sulfuric acid was the preferred treating material for all petroleum fractions from naphtha to lubricating oil for a century and is still used. However, the reactions of sulfuric acid with petroleum fractions are complex. The undesirable components to be removed are generally present in small amounts; large excesses of acid are required for efficient removal, which may cause marked changes in the remainder of the hydrocarbon mixture.

The *sulfuric acid treatment* process is a continuous or batch method that is used to remove sulfur compounds. The treatment will also remove asphaltic materials from various refinery stocks. The acid strength varies from fuming (>100%) to 80%; approximately 93% acid finds the most common use. The weakest suitable acid is used for each particular situation to reduce sludge (black acid) formation from the aromatic and olefin hydrocarbons. Sulfides and disulfides are removed by addition reactions with aluminum chloride or by solution with sulfuric acid. Cyclic sulfides, such as tetramethylene and pentamethylene sulfide as well as sulfones [ $\text{R}^1\text{S}(=\text{O})\text{R}^2$ ] and sulfoxides [ $\text{R}^1\text{S}(\text{O})_2\text{R}^2$ ] are also removed by solution in the acid.

The use of strong acid dictates the use of a fairly low temperature (-4 to 10 °C, 25 to 50 °F), but higher temperatures (20 to 55 °C, 70 to 130 °F) are possible if the product is to be redistilled.





# Black Oil

The term *black oil* is a confusing term that has recently been applied to crude oil on the basis of (1) color or (2) asphaltene content or (3) both. It is a term that should be used with caution and should only be used when defined in detail. For example, on the basis of color, Arabian heavy crude oil (28° API) might be termed black oil as is Lloydminster (Alberta, Canada) heavy oil (14° API) but both are vastly different in terms of properties, recovery, and refining. Hence, after introduction of the term *black oil*, it is recognized that the term is a misnomer since the color of the oil is not always black and other terms such as *low-shrinkage crude oil* and *ordinary oil* have also been introduced.

In an attempt to justify the use of the term, *black oil* has been identified (and the only way it is characterized) by having initial producing gas-oil ratios of 2,000 ft<sup>3</sup>/bbl or less. Volatile oil (*high-shrinkage crude oil, near-critical oil*) is identified as having initial gas-oil producing ratios on the order of 2,000 to 3,300 ft<sup>3</sup>/bbl. This invokes use of a clear line of demarcation 2,000 ft<sup>3</sup>/bbl and the difference between oil having a gas-oil producing ration of 1,950 ft<sup>3</sup>/bbl and

another oil having a gas-oil producing ration of 2,050 ft<sup>3</sup>/bbl may not be clear.

The terms conventional petroleum (light oil), heavy oil, extra heavy oil, and bitumen are more in keeping with the varying nature of these materials which are defined on the basis of the recovery method rather than a specific property (such as color or asphaltene content). For example, *tar sands* have been defined in the United States (FE-76-4) as:

*...the several rock types that contain an extremely viscous hydrocarbon which is not recoverable in its natural state by conventional oil well production methods including currently used enhanced recovery techniques. The hydrocarbon-bearing rocks are variously known as bitumen-rocks oil, impregnated rocks, oil sands, and rock asphalt.*

By inference, heavy oil can be recovered in its natural state by enhanced oil recovery techniques while conventional crude oil can be recovered in its natural state by secondary and primary recovery techniques. Also by inference, black oil does not reliably fit into this definition.



# Blending and Mixing

Typically, the term blending as used in the petroleum industry is (1) the procedure by which two or more crude oils are mixed to satisfy refinery needs or (2) the procedure by which two or more refinery products are mixed so that the final blend (mixture) meets product specifications for sale to the consumer (Figure 1, Figure 2).

Single-stage side entering mixers are used for blending purposes. The side entering propeller-type mixer is economical and establishes an effective flow pattern in almost any size tank. Because the shaft seal is below the liquid level, its use in fluids without corrosive and erosive properties is usually ideal. Top entering mixers are heavy duty equipment and are usually fixed to a rigid structure or tank mounting. Either radial flow or axial flow turbines may be used. Speeds vary from 50 to 100 rpm and usually require a double set of helical gearing or a single set of worm gears to achieve these low speeds. Therefore, they are more expensive than single reduction mixers. Slow speed close-clearance impellers are used when mixing high viscosity materials. Helical or anchor type close-clearance impellers are used in this application at speeds from 5 to 20 rpm.

A line blender is a mixer placed directly in process piping when mixing times of several seconds are required. Agitation in a line blender is sufficient to disrupt the flow pattern through the pipe so that one or two stages of mixing are accomplished. Particular attention must be paid to the pressure drop through this type of mixer when selecting pumps for the piping system.

On the other hand, multi-stage mixers are specified when (1) one liquid must be dissolved in another, (2) a solid and a liquid must be mixed, (3) a high viscosity liquid must be reacted, (4) a light liquid must be extracted from a mixture of heavy and light liquids, or (5) when gas must be absorbed in a liquid. To select the proper multi-stage mixer, certain fluid properties must be known such as:

1. The required-specific gravity of components and the mixture.
2. The fluid viscosity – for Newtonian fluids (a constant viscosity at all impeller speeds) an approximate viscosity up to 5,000 centipoises are satisfactory but above 5,000 centipoises, estimating errors of 20 to 50% can mean undersizing or oversizing the agitator. However, for non-Newtonian fluids, viscosity data are very important since every impeller has an average fluid shear rate related to speed.
3. The characteristics of the phase to be dispersed must be known in order to prevent phase separation and incompatibility of the components of the blend.
4. For solid-liquid systems, settling velocity of the 10, 50, and 90% w/w fractions of particle size distribution must be available from calculations or measurements.
5. With gases, the flow rate must be available at standard temperature and pressure as well as actual temperature and pressure. The range of gas flow must be given, as well as whether the mixer is to be operated at full horsepower for all gas ranges.

The desired property of the blended product may be determined using the following relationship:

$$P_{\text{Blend}} = \frac{\sum_{i=1}^n q_i P_i}{\sum_{i=1}^n q_i}$$

In this equation,  $P_i$  is the value of the property of component  $i$  and  $q_i$  is the mass, volume or molar flow rate of

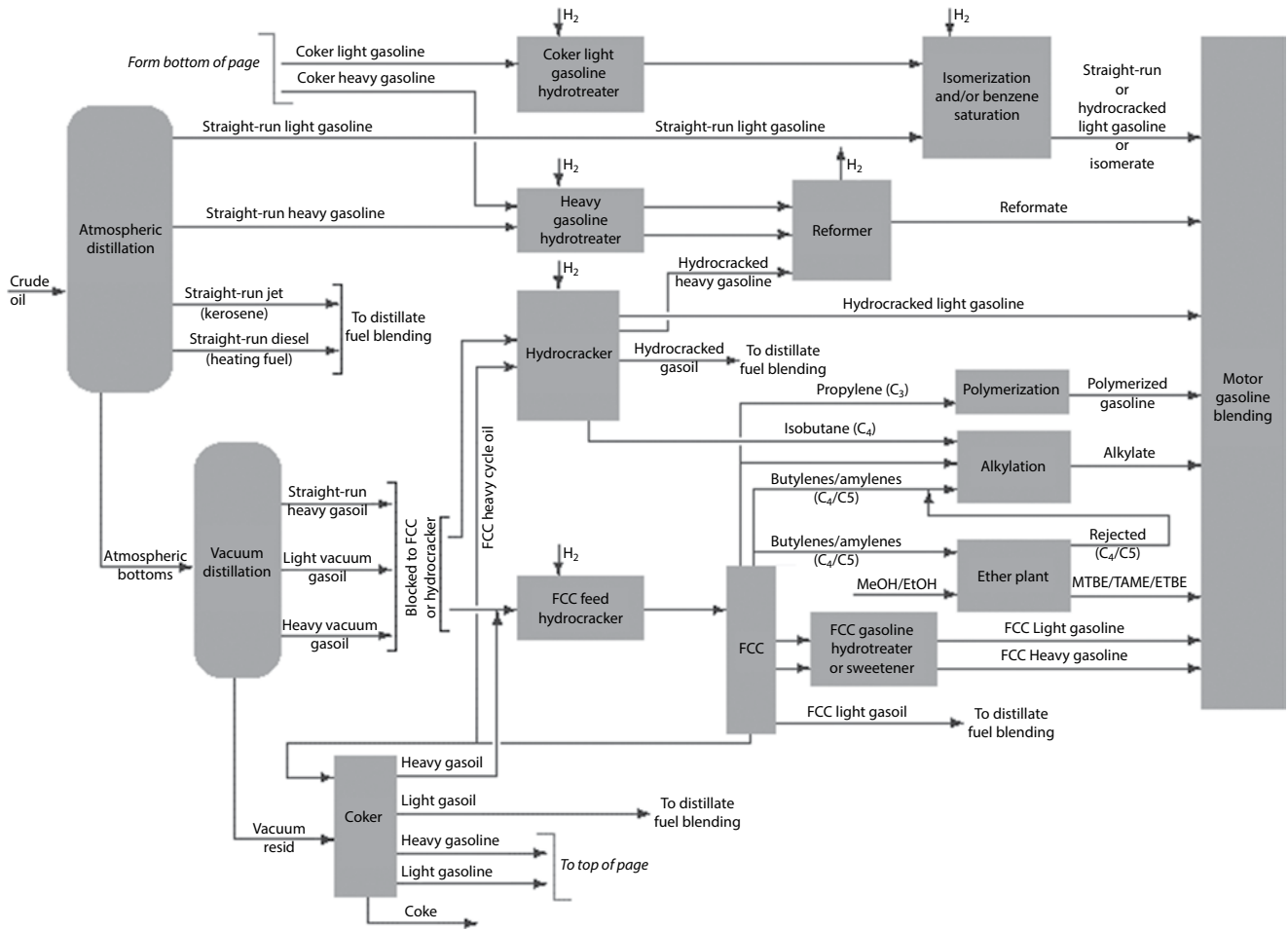

Figure 1 Refinery streams that are blended to produce gasoline.

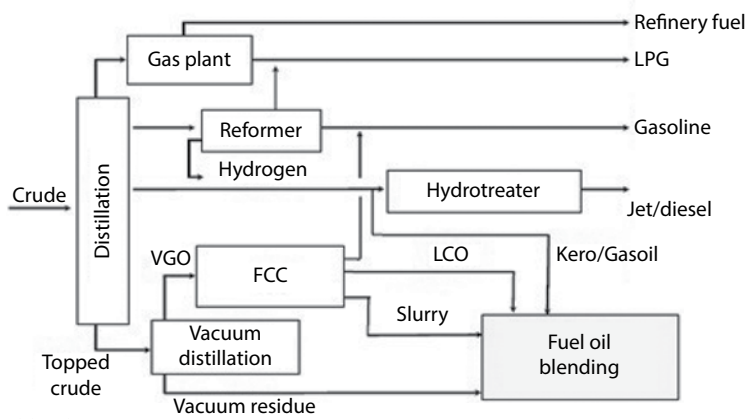

Figure 2 Fuel oil production by blending.

component  $i$  contributing to the total amount of the finished product.

This equation is based on the assumption that the given property is additive (or linear). Additive properties include specific gravity, boiling point and sulphur content. However, properties such as viscosity, flash temperature, pour point, aniline point, Reid vapor pressure (RVP), and cloud point are not always additive because of the occurrence of intermolecular and intramolecular interactions between the blended constituents, which may require the development of individual relationships. For example, a commonly used RVP index is based on an empirical relationship:

$$BI_{RVP_i} = RVP_i^{1.25}$$

$BI_{RVP_i}$  is the RVP blending index for component  $i$  and  $RVP_i$  is the Reid vapor pressure component  $i$  in psi.

In addition, the flash point of a blend can be determined using the following equation:

$$BI_{FP,Blend} = \sum_{i=1}^n x_{vi} BI_{FP_i}$$

where  $x_{vi}$  is the volume fraction of component  $i$ , and  $BI_{FP_i}$  is the flash point index of component  $i$  that can be determined from the following correlation:

$$BI_{FP_i} = FP_i^{1/x}$$

$FP_i$  is the flash point temperature of component  $i$ , in °K, and the value of  $x$  is  $-0.06$ .

Similar relationships can be developed for pour point blending, cloud point blending, aniline point blending, smoke point blending, octane number blending, and viscosity blending.



# Boiling Point and Boiling Range

The *boiling point* is a characteristic physical property of a single-component liquid (Figure) at which the vapor pressure is equal to that of the atmosphere and the liquid is converted to a gas. In the petroleum industry, many of the products are complex mixtures and *boiling range* is the more frequently used term when applied to fractions derived from crude oil by distillation (Table). The boiling points of the individual constituents of natural gas and petroleum (Figure) contribute to the boiling range.

At temperatures below the boiling point, evaporation takes place only from the surface of the liquid; during boiling, vapor forms within the body of the liquid; and as the vapor bubbles rise through the liquid, they cause the turbulence and seething associated with boiling. If the liquid is a single substance or an azeotropic solution (a mixture

that has a constant boiling point), it will continue to boil as heat is added without any rise in temperature – boiling occurs at constant temperature regardless of the amount of heat applied to the liquid. When the pressure on a liquid is increased, the boiling point increases. Conversely, if the pressure on a liquid is reduced, the boiling point is decreased.

On the other hand, the *boiling range* is the range of temperature, usually determined at atmospheric pressure in standard laboratory apparatus, over which the distillation of oil commences, proceeds, and finishes (Table). Like the boiling point, the *boiling range* is usually determined at atmospheric pressure in standard laboratory apparatus, over which the distillation of oil commences, proceeds, and finishes.

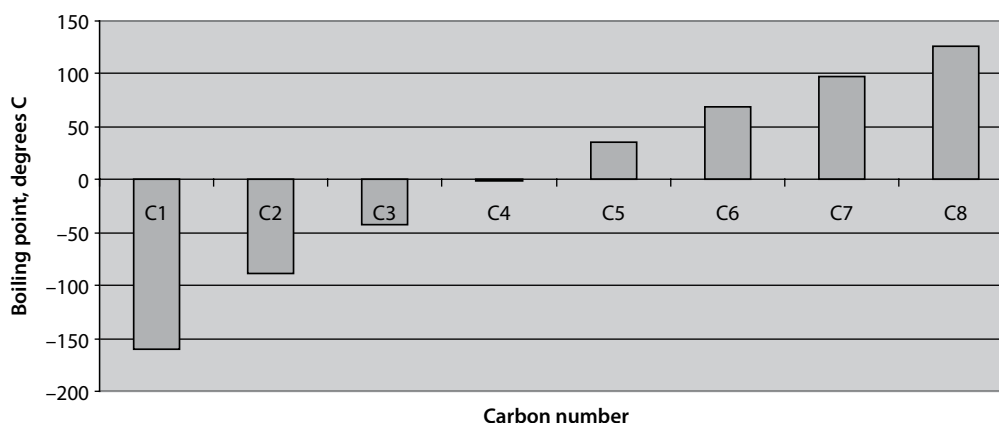

**Figure** Carbon number and boiling points of natural gas hydrocarbons (up to n-Octane,  $C_8H_{18}$ ).

**Table** Example of the boiling ranges of crude oil fractions.

Product	Lower carbon limit	Upper carbon limit	Lower boiling point °C	Upper boiling point °C	Lower boiling point °F	Upper boiling point °F
Refinery gas	C1	C4	-161	-1	-259	31
Liquefied petroleum gas	C3	C4	-42	-1	-44	31
Naphtha	C5	C17	36	302	97	575
Gasoline	C4	C12	-1	216	31	421
Kerosene/diesel fuel	C8	C18	126	258	302	575
Aviation turbine fuel	C8	C16	126	287	302	548
Fuel oil	C12	>C20	216	421	>343	>649
Lubricating oil	>C20		>343		>649	
Wax	C17	>C20	302	>343	575	>649
Asphalt	>C20		>343		>649	
Coke	>C50*		>1000*		>1832*	

\*Carbon number and boiling point difficult to assess; inserted for illustrative purposes only.



# Brine

Brine is an aqueous solution of salts that occur with gas and crude oil; seawater and saltwater are also known as brine. At 15.5 °C (60 °F) saturated sodium chloride brine is 26.4% sodium chloride by weight (100 degree SAL). At 0 °C (32 °F) brine can only hold 26.3% salt. Brine is at the high end of the water salinity scale (Table). Brine is corrosive to metal and there must be periodic inspection of

pipelines and other metals systems with which brine comes into contact.

**Table** Water Salinity based on dissolved salts (parts per thousand).

<b>Fresh water</b>	<b>Brackish water</b>	<b>Saline water</b>	<b>Brine</b>
<0.5	0.5–30	30–50	>50



# Bubble Point and Bubble Point Pressure

The bubble point is the temperature at which incipient vaporization of a liquid in a liquid mixture occurs, corresponding with the equilibrium point of 0% vaporization or 100% condensation. The bubble point is based on the fact that liquid is held in the pores of the filter by surface tension and capillary forces. The minimum pressure required to force liquid out of the pores is a measure of the pore diameter. The pressure required to force liquid out of a liquid-filled capillary must be sufficient to overcome surface tension and is a direct measure of effective tube diameter. At a given temperature, when the pressure decreases and below the bubble point curve, gas will be emitted from the liquid phase to the two-phase region.

At the bubble point, the following relationship holds:

$$\sum_{i=1}^{N_c} y_i = \sum_{i=1}^{N_c} K_i x_i = 1$$

where

$$K_i \equiv \frac{y_{ie}}{x_{ie}}$$

$K$  is the *distribution coefficient* or  $K$  factor, defined as the ratio of mole fraction in the vapor phase ( $y_{ie}$ ) to the mole fraction in the liquid phase ( $x_{ie}$ ) at equilibrium.

When Raoult's law and Dalton's law hold for the mixture, the  $K$  factor is defined as the ratio of the vapor pressure to the total pressure of the system:

$$K_i = \frac{P_i'}{P}$$

Given either of  $x_i$  or  $y_i$  and either the temperature or pressure of a two-component system, calculations can be performed to determine the unknown information.

A bubble point test is a test method that is designed to determine the pressure at which a continuous stream

of bubbles is initially seen downstream of a wetted filter under gas pressure. The bubble point test is a practical, non-destructive test used for estimating the pore size of microporous filters and confirming the integrity of sterilizing membrane filters and filter systems. It is the most widely used non-destructive integrity test. To perform a *bubble point test*, gas is applied to one side of a wetted filter, with the tubing downstream of the filter submerged in a bucket of water. The filter must be wetted uniformly such that water fills all the voids within the filter media. When gas pressure is applied to one side of the membrane, the test gas will dissolve into the water, to an extent determined by the solubility of the gas in water. Downstream of the filter, the pressure is lower. Therefore, the gas in the water on the downstream side is driven out of solution. As the applied upstream gas pressure is increased, the diffusive flow downstream increases proportionally. At some point, the pressure becomes great enough to expel the water from one or more passageways establishing a path for the bulk flow of air. As a result, a steady stream of bubbles should be seen exiting the submerged tubing. The pressure at which this steady stream is noticed is referred to as the bubble point.

The *bubble point pressure* ( $P_b$ ) is the pressure at which saturation will occur in the liquid phase (for a given temperature) and is the point at which vapor (bubble) first starts to come out of the liquid (due to pressure depletion). The bubble-point pressure  $p_b$  of a hydrocarbon system is the highest pressure at which a bubble of gas is first liberated from the oil. This important property can be measured experimentally for a crude oil system by conducting a constant-composition expansion test.

The bubble point temperature is usually lower than the dew point temperature for a given mixture at a given pressure. Since the vapor above a liquid will probably have a different composition to the liquid, the bubble point (along with the *dew point*) data at different compositions are useful data when designing distillation systems and for constructing

phase diagrams as a means of studying phase relationships. As pressures are reduced below the bubble point, the relative volume of the gas phase increases. For pressures above the bubble point, a crude oil is said to be undersaturated. At or below the bubble point, the crude is saturated.

In the absence of the experimentally measured bubble-point pressure, it is necessary to make an estimate of this

crude oil property from the readily available measured producing parameters. These correlations are essentially based on the assumption that the bubble-point pressure is a strong function of gas solubility  $R_s$ , gas gravity  $\gamma_g$ , oil gravity in  $^\circ\text{API}$ , and temperature  $T$ :

$$p_b = f(R_s, \gamma_g, ^\circ\text{API}, T)$$

# Bureau of Mines Correlation Index

The Bureau of Mines Correlation Index (BMCI) is based on the medium volumetric boiling point and 15.6/15.6 °C density:

$$\text{BMCI} = 48640/PEMV + 473.7 d_{60/60} - 456.8$$

In this equation, *PEMV* is medium volumetric boiling point (*K*).

The index is applied to the calculation of low-boiling fractions (mainly naphtha fractions) destined to petrochemical or solvent plants. Values range between zero (0) (paraffin crude oils or fractions thereof) and one hundred (100) (aromatic crude oils or fractions thereof).



# Calorific Value

The calorific value is a direct indication of the heat content (energy value) of a fuel and represents the combined heats of combustion of the carbon, hydrogen, nitrogen, and sulfur in the organic matter and of the sulfur in pyrite and is as the gross calorific value with a correction applied if the net calorific value is of interest.

The calorific value is usually expressed as the *gross calorific value* (GCV) or the *higher heating value* (HHV) and the *net calorific value* (NCV) or *lower calorific value* (LHV). The difference between the gross calorific value and the net calorific value is the latent heat of condensation of the water vapor produced during the combustion process. The gross calorific value assumes that the entire vapor produced during the combustion process is fully condensed. The net calorific value assumes that the water is removed with the combustion products without fully being condensed. To equalize all effects, the calorific value of crude oil and crude oil products should be compared based on the net calorific value basis.

**Table** Calorific values (higher heating values, HHV and lower heating values, LHV) of selected fuels.

Fuel	HHV MJ/kg*	HHV BTU/lb	LHV MJ/kg*
Hydrogen	141.8	61,000	119.96
Methane	55.5	23,900	50
Ethane	51.9	22,400	47.622
Propane	50.35	21,700	46.35
Butane	49.5	20,900	45.75
Pentane	48.6	21,876	45.35
Paraffin wax	46	19,900	41.5
Kerosene	46.2	19,862	43
Diesel	44.8	19,300	43.4

\*1 MJ/kg = 430 BTU/lb).





# Capillary Forces

Capillary forces are the interfacial forces between immiscible fluid phases, resulting in pressure differences between the two phases. Capillary action, capillarity, capillary motion, or wicking is the ability of a substance to draw another substance into it. Such forces occur when the adhesive intermolecular forces between the liquid and a substance are stronger than the cohesive intermolecular forces inside the liquid. The effect causes a concave meniscus to form where the substance is touching a vertical surface. The same effect is what causes porous materials such as sponges to soak up liquids.

Oil recovery is a process affected by simultaneous competition between three forces: (1) capillary forces, (2) viscosity, and (3) gravity.

Capillary forces retain the fluids in the porous media while applied viscous forces intend to produce oil by fluid/fluid displacement, e.g., producing oil by injecting water. Due to density differences between gas, oil and water gravity always tries to separate the fluid phases by gravity segregation.



# Capillary Number

The capillary number ( $N_c$ ) is the ratio of viscous forces to capillary forces, and equal to viscosity times velocity divided by interfacial tension. A common experimental observation is a relationship between residual oil saturation ( $S_{or}$ ) and local capillary number ( $N_c$ ). This relationship is called a capillary desaturation curve (CDC).

The capillary number reflects the balance between viscous and capillary forces at the pore scale; viscous forces dominate at high capillary numbers while capillary forces dominate at low capillary numbers. The capillary number at the pore scale can be defined as:

$$N_c = \mu v / \gamma \cos\theta$$

In the equation,  $\mu$  is the water viscosity,  $v$  is the linear advance rate,  $\gamma$  is the oil-water interfacial tension and  $\theta$  is the contact angle.

If the viscous forces acting on the trapped oil exceed the capillary retaining forces, residual oil can be mobilized. This is reflected in CDC curves which show that while  $S_{or}$  values are constant at low values of the capillary number, they start to decrease above a certain value of the capillary number termed the critical capillary number.



# Capillary Pressure

The capillary forces in a reservoir are the result of the combined effect of the surface and interfacial tensions of the rock and fluids, the pore size and geometry, and the wetting characteristics of the system. Any curved surface between two immiscible fluids has the tendency to contract into the smallest possible area per unit volume. This is true whether the fluids are oil and water, water and gas (even air), or oil and gas. When two immiscible fluids are in contact, a discontinuity in pressure exists between the two fluids, which depends upon the curvature of the interface separating the fluids. This pressure difference is the *capillary pressure* ( $P_c$ ). Thus, capillary pressure is the difference in pressure across the interface between two phases and has also been defined as the pressure differential between two immiscible fluid phases occupying the same pores caused by interfacial tension between the two phases that must be overcome to initiate flow.

The capillary pressure between adjacent oil and water phases,  $P_{cow}$ , can be related to the principal radii of curvature  $R_1$  and  $R_2$  of the shared interface and the interfacial tension  $\sigma_{ow}$  for the oil/water interface:

$$P_{cow} = p_o - p_w = \sigma_{ow} \left( \frac{1}{R_1} + \frac{1}{R_2} \right)$$

In this equation,

$p_o$  = pressure in the oil phase, m/Lt<sup>2</sup>, psi

$p_w$  = pressure in the water phase, m/Lt<sup>2</sup>, psi

$P_{cow}$  = capillary pressure between oil and water phases, m/Lt<sup>2</sup>, psi

$R_1, R_2$  = principal radii of curvature, L

$\sigma_{ow}$  = oil/water interfacial tension, m/t<sup>2</sup>, dyne/cm

The relationship between capillary pressure and fluid saturation could be computed in principle, but this is rarely attempted except for very idealized models of porous media.

The displacement of one fluid by another in the pores of a porous medium is either aided or opposed by the surface forces of capillary pressure. As a consequence, in order to maintain a porous medium partially saturated with non-wetting fluid and while the medium is also exposed to wetting fluid, it is necessary to maintain the pressure of the non-wetting fluid at a value greater than that in the wetting fluid. Also, denoting the pressure in the wetting fluid by  $P_w$  and that in the non-wetting fluid by  $P_{nw}$ , the capillary pressure can be expressed as:

$$P_c = P_{nw} - P_w$$

That is, the pressure excess in the non-wetting fluid is the capillary pressure, and this quantity is a function of saturation. In addition, there are three types of capillary pressure: (1) water-oil capillary pressure,  $p_{cwo}$ , (2) gas-oil capillary pressure,  $p_{cgo}$ , and gas-water capillary pressure ( $p_{cgw}$ ). Applying the mathematical definition of the capillary pressure, the three types of the capillary pressure can be written as:

$$P_{cwo} = p_o - P_w$$

$$P_{cgo} = p_g - P_o$$

$$P_{cgw} = p_g - P_w$$



# Carbon Monoxide and Carbon Dioxide

Carbon monoxide is produced from the partial oxidation of carbon-containing compounds; it forms when there is not enough oxygen to produce carbon dioxide (CO<sub>2</sub>). In the presence of oxygen, including atmospheric concentrations, carbon monoxide burns with a blue flame, producing carbon dioxide. Carbon dioxide (CO<sub>2</sub>) is a colorless and odorless gas that is in natural gas and petroleum reservoirs. Both gases can occur as a result of gas processing operations and refining operations.

**Table 1** Physical properties of carbon monoxide.

Molecular weight	28.01
Specific volume @ 21 °C, 1 atm	13.8 cu.ft/lb (861.5 ml/g)
Boiling point @ 1 atm	-191.5 °C
Triple point	-205.01 °C
Specific gravity @ 21 °C, 1 atm	115.14 mm Hg
Density (liquid) @ bp	0.9678
Latent heat of vaporization @ bp	1444 cal/mole
Latent heat of fusion @ tp	200.9 cal/mole
Flammable limits in air	12.5-74%
Autoignition temperature	650 °C
Specific heat (gas) @ 25 °C, 1 atm	
C <sub>p</sub>	0.2491 cal/g °C
C <sub>v</sub>	0.1774 cal/g °C
ratio C <sub>p</sub> /C <sub>v</sub>	1.4
Viscosity (gas) @ 0 °C, 1 atm	0.0166 centipoise
Entropy (gas) @ 25 °C	47.266 cal/mole °C
Heat of formation (gas) @ 25 °C	-26.417 kcal/mole

**Table 2** Physical properties of carbon dioxide.

Molecular weight	44.01
Vapour pressure at 21 °C	57.23 bar
Specific volume at 21 °C, 1 atm	547 ml/g
Sublimation point at 1 atm	- 78.5 °C
Triple point at 5.11 atm	- 56.6 °C
Density, gas at 0 °C, 1 atm	1.977 g/l
Specific gravity, gas at 0 °C, 1 bar (air = 1)	1.521
Critical temperature	31 °C
Critical pressure	73.9 bar
Critical density	0.468 g/ml
Latent heat of vaporization	
at triple point	83.2 cal/g
at 0 °C	56.2 cal/g
Specific heat, gas at 25 °C, 1 atm	
C <sub>p</sub>	0.205 cal/g °C
C <sub>v</sub>	0.1565 cal/g °C
ratio C <sub>p</sub> /C <sub>v</sub>	1.310
Thermal conductivity at 0 °C	3.5 × 10 <sup>-5</sup> cal/s cm <sup>2</sup> °C/cm
at 100 °C	5.5 × 10 <sup>-5</sup> cal/s cm <sup>2</sup> °C/cm
Viscosity, gas at 21 °C, 1 atm	0.0148 cP
Entropy, gas at 25 °C, 1 atm	1.160 cal/g °C
Heat of formation, gas at 25 °C	-2137.1 cal/g
Solubility in water at 25 °C, 1 atm	0.759 vol/vol water





## Carbon Number and Possible Isomers

It is theoretically impossible to completely separate and purify the individual components of petroleum when the possible number of isomers are considered for the individual carbon numbers that occur within the paraffin family (Table). When other types of compounds are included, such

as the aromatic derivatives and heteroatom derivatives, even though the maturation process, by which crude oil and was formed, might limit the possible number of isomeric permutations, the potential number of compounds in petroleum is still (in a sense) astronomical.

**Table** Boiling point of the n-isomers of the various paraffin derivatives and the number of possible isomers associated with each carbon number.

Number of carbon atoms	Boiling point n-isomer °C	Boiling point n-isomer °F	Number of isomers
5	36	97	3
10	174	345	75
15	271	519	4,347
20	344	651	366,319
25	402	755	36,797,588
30	450	841	4,111,846,763
40	525	977	62,491,178,805,831



# Carbonate Reservoir

A carbonate reservoir is a reservoir in which the majority of the reservoir rocks are mineral carbonates, such as calcium carbonate ( $\text{CaCO}_3$ ) and magnesium carbonate ( $\text{MgCO}_3$ ). Approximately 50% of the world's present proven petroleum reserves are contained in carbonate reservoirs, and about 60% of the proven reserves occur in giant carbonate oil fields. Carbonate rocks are distinctive and complex compared to clastic sandstone reservoir rocks. Pre-burial carbonate sediments exist as reef structures, loose biological grains, chemical precipitates, and recycled, eroded carbonate rocks. These sediments are exposed to marine dispersal processes and undergo organic binding providing a wide range of particle size and sorting.

Carbonate sediments lithify early, becoming susceptible to repeat fracturing throughout their burial history.

Also carbonate depositional patterns change over geological time owing to the evolution of framework building biota. This presents a challenge in identifying hydrocarbon accumulations in carbonate facies. Sedimentary facies are distinguished by lithological (lithofacies), petrophysical (microfacies), and paleontological (biofacies) attributes. Analyzing carbonate depositional profiles and their facies distribution based on biota associations uniquely defines the character of carbonate reservoir systems. In geology, the term *facies* is used to describe a body of rock with specified characteristics which can be any observable attribute of rocks such as their overall appearance, composition, or condition of formation, and the changes that may occur in those attributes over a geographic area.



# Carbonate Washing and Water Washing

Carbonate washing and water washing are chemical conversion processes in which acid contaminants in natural gas are removed from the stream (Figure 5).

Carbonate washing is a mild alkali process for emission control by the removal of acid gases (such as carbon dioxide and hydrogen sulfide) from gas streams and uses the principle that the rate of absorption of carbon dioxide by potassium carbonate increases with temperature.

It has been demonstrated that the process works best near the temperature of reversibility of the reactions:

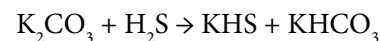
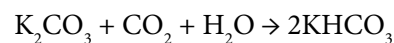

Water washing, in terms of the outcome, is analogous to washing with potassium carbonate and it is also possible to carry out the desorption step by pressure reduction. The absorption is purely physical and there is also a relatively high absorption of hydrocarbons, which are liberated at the same time as the acid gases.



## Catalyst Pore Diameter

The average pore diameter (APD, in Angstrom units) of a catalyst can be calculated by using the following equation using the pore volume (PV) and surface area (SA):

$$APD = (PV \times 4 \times 10,000) / SA$$

One Angstrom (Ångström) unit is equivalent to  $1 \times 10^{-10}$  meter) or 0.1 nanometer.





# Catalytic Materials

Catalytic materials, in most cases, consist of an active metal or a metal oxide deposited on a carrier material. To attain adequate contact surface for the molecules, the carrier material has a high surface area, typically between 50 and 1000 m<sup>2</sup>/gm, which can only be achieved with highly porous materials.

It is possible to deposit catalytically active metals on these carrier materials. The sizes of the metal particles are typically very small, usually a few nanometers. The metal particles on the surface have an average diameter of 5 to 10 nanometers.

**Table** Surface areas of some typical carrier materials.

Carrier	Surface area, m <sup>2</sup> /gm
Aluminum oxide (AlO <sub>3</sub> )	up to 200
Silica (SiO <sub>2</sub> )	up to 200
Zeolites	greater than 500
Active carbon	up to 2000



# Catalytic Reforming

The catalytic reforming processes (Table 1) is a thermal treatment in the presence of a catalyst that serves to improve a gasoline octane number and may be accomplished in part by an increase in the volatility (reduction in molecular size) or chiefly by the conversion of *n*-paraffins to *iso*-paraffins, olefins, and aromatics and the conversion of naphthenes

to aromatics (Table 2). The nature of the final product is of course influenced by the source (and composition) of the feedstock. In thermal reforming, the reactions resemble the reactions that occur during gas oil cracking: i.e., molecular size is reduced, and olefins and some aromatics are produced.

**Table 1** Parameters for the catalytic reforming process.

Feedstock	Catalytic Reforming	Products
Heavy naphtha $C_7-C_{10}$ RON : 20 – 50 P: 45– 65 vol% N: 20–40 vol% A: 15-20 vol%	Reaction Conditions Temp : 500°C Pressure : 5 -25 bar Platinum-based catalyst High heat demand SR: Semi-Regenerative CCR: Continuous Catalyst Regeneration	$C_5^+$ Reformate RON : 90 – 100 $H_2, C_1, C_2, C_3, C_4$ Coke P : 30 – 50 vol% N : 5 – 10 vol% A: 45 – 60 vol%

**Table 2** Reforming reactions.

## 5.2.4.1. Naphthene Dehydrogenation of Cyclohexanes

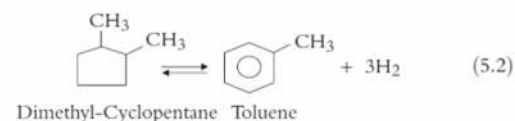
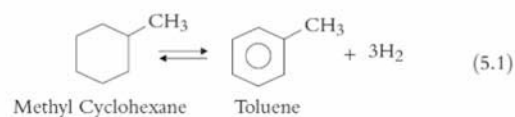

## 5.2.4.2. Paraffin Dehydrogenation

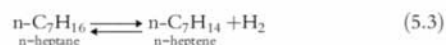

## 5.2.4.3. Dehydrocyclization

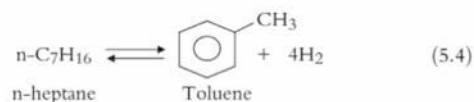

All the above reactions are highly endothermic.



# Cementation Value

Cementation refers to the event in a sediment where new minerals stick the grains together. The process involves ions carried in groundwater chemically precipitating to form new crystalline material between sedimentary grains. The new pore-filling minerals form bridges between original sediment grains, thereby binding them together. In this way, *sand* becomes sandstone and *gravel* becomes conglomerate or breccia.

Cementation occurs as part of the diagenesis or lithification of sediments and occurs primarily below the water table regardless of sedimentary grain sizes present. Large volumes of pore water must pass through sediment pores for new mineral cements to crystallize and so millions of years are generally required to complete the cementation process. Common mineral cements include calcite, quartz, or silica phases such as cristobalite, iron oxides, and clay minerals.

The cementation factor (also the cementation exponent,  $m$ ) varies from approximately 1.3 to 2.6 (Table) and is

dependent on (or an indicator of) the rock lithology, especially (1) the shape, type, and size of grains, (2) the shape and size of pores and pore throats, and (3) the size and number of dead-end (or cul-de-sac) pores. The dependence of the cementation factor on the degree of cementation is not as strong as its dependence on the shape of grains and pores.

**Table** Lithology and cementation values.

<i>Lithology</i>	<i>Cementation value</i>
Unconsolidated rocks (loose sands limestones)	1.3
Very slightly cemented	1.4–1.5
Slightly cemented (sands with >20% porosity)	1.6–1.7
Moderately cemented (consolidated <15%)	1.8–1.9
Highly cemented (quartzite, limestone, dolomite)	2.0–2.2



# Cetane Index

The Cetane index is an approximation of the cetane number calculated from the density and mid-boiling point temperature; the ignition quality of diesel fuel can also be estimated from the following formula:

$$\text{Diesel index} = (\text{aniline point } (^{\circ}\text{F}) \times \text{API gravity})100$$

However, the Cetane index is calculated based on the density and boiling range of the fuel. There are two methods (ASTM D976, ASTM D4737).

Standard Test Method ASTM D976 uses two variable equations to determine CI from the diesel's mid-boiling point and density. Calculated Cetane index:

$$CI_{97} = 454.74 - 1641.416D + 774.74D^2 - 0.554B + 97.803(\log B)^2$$

Where:  $D$  = density at 15 °C [g/mL] determined by Test Method ASTM D 1298

$B$  = mid-boiling temperature [°C] determined by Test Method ASTM D 86 and corrected to standard barometric pressure.

Standard Test Method ASTM D 4737 calculates CI using a four variable equation based on diesel's low, mid and high boiling points as well as density. Calculated Cetane index:

$$CI_{4737} = 45.2 + 0.0892T_{10N} + [0.131 + 0.901B]T_{50N} + [0.0523 + 0.420B]T_{90N} + 0.00049[T_{10N}^2 - T_{90N}^2] + 107B + 60B^2$$

where:  $D$  = density at 15 °C [g/mL] determined by Test Method ASTM D 1298,  $B = [e^{(-3.5)(D - 0.85)}] - 1$ ,  $T_{10}$  = 10% distillation temperature [°C] determined by Test Method ASTM D 86 and corrected to standard barometric pressure,  $T_{10N} = T_{10} - 215$ ,  $T_{50}$  = 50% distillation temperature [°C] determined by Test Method ASTM D 86 and corrected to standard barometric pressure,  $T_{50N} = T_{50} - 260$ ,  $T_{90}$  = 90% distillation temperature [°C] determined by Test Method ASTM D 86 and corrected to standard barometric pressure,  $T_{90N} = T_{90} - 310$ .





# Characterization Factor

The UOP characterization factor, K, factor is one of the more widely used derived characterization or classification factors. It was originally devised to show the thermal cracking characteristics of heavy oil. The factor is defined as the ratio of the cube root of the molal average boiling point,  $T_B$ , in degrees Rankine ( $^{\circ}R = ^{\circ}F + 460$ ), to the specific gravity at 60  $^{\circ}F/60$   $^{\circ}F$ :

$$K_{UOP} = (CABP + 460)^{1/3}/SG$$

The Watson characterization factor is determined similarly:

$$K_w = (MeABP + 460)^{1/3}/SG$$

CABP is the cubic average boiling point in  $^{\circ}F$ ; MeABP is the mean average boiling point in  $^{\circ}F$ ; and SG is the specific

gravity at 60  $^{\circ}F$ . Highly paraffin oils have K in the range 12.5 to 13.0 and cyclic (naphthene) oils have K in the range 10.5 to 12.5.

Despite the fact that information may be obtained on oil and oil fractions chemical composition using characterization factors, this information has a limited scope. If applied to oil, factors indicate the chemical nature with reasonable accuracy and keep an optimum relation with other properties like the carbon-hydrogen ratio. Alone, these factors do not provide further details on oil chemical composition but, if used together and supported by other properties, information can be obtained allowing characterization. Factors, especially the Watson factor, are used to estimate the properties of crude oil fractions and products from crude oil refining.



# Chemical Reaction Rates

Thermodynamics describes the energy requirements of a reaction; the speed at which it progresses is termed kinetics. It is important to be able to control the rate of chemical reactions for commercial and safety reasons. If a reaction takes too long to progress, the rate at which a product is manufactured would not be viable. Alternatively, if reactions progress too fast and 'run away' out of control there could be dangers such as explosions. The rate at which reactions take place can be affected by the concentration of reactants, pressure, temperature, wavelength and intensity of light, size of particles of solid reactants, or the presence of catalysts (i.e., substances which alter the speed of reactions without being consumed during the reaction) or impurities.

The rate equation for a chemical reaction is an equation that links the reaction rate with concentrations or pressures of reactants and constant parameters. Typically, the reaction rate,  $r$ , is given by:

$$r = k[A]^x[B]^y$$

In this equation,  $[A]$  and  $[B]$  express the concentration of the species A and B, respectively (usually in moles per liter, M). The exponents  $x$  and  $y$  are the partial reactions orders and are determined experimentally – for some reactions,

these exponents may not be equal to the stoichiometric coefficients. The constant  $k$  is the reaction rate constant (*rate coefficient*) of the reaction and the value of this coefficient typically depends on the reaction parameters such as temperature.

Catalysts tend to be specific to a particular reaction or family of reactions. Thus nickel is used to facilitate hydrogenation reactions (e.g., add hydrogen to C=C double bonds) whereas platinum is used to catalyze certain oxidation reactions. Sometimes care is needed with the purity of reactants since impurities can act as unwanted catalysts; alternatively, catalysts can be inactivated by *poisoning*.

For reactions which progress slowly at room temperature it may be necessary to heat the mixture or add a catalyst for the reaction to occur at an economically viable rate. For very fast reactions the mixture may need to be cooled or solvent added to dilute the reactants and hence reduce the speed of reaction to manageable proportions. In general, the rate of a chemical reaction (1) doubles for every 10 °C rise in temperature, (2) is proportional to the concentration of reactants in solution, (3) increases with decreased particle size for reactions involving a solid, and (4) increases with pressure for gas phase reactions.



# Chemicals Reactive with Water

Chemicals that are reactive with water (water reactive chemicals) are substances that are reactive and dangerous when wet because of a chemical reaction with water. This reaction may release a gas that is either flammable or presents a toxic health hazard or both. In addition, the heat generated when water contacts such materials is often enough for the item to spontaneously combust and even explode. These chemicals can pose a threat to any operation in which chemicals are required to improve the process.

Examples of water-reactive chemicals are the alkali metals, the alkaline earth metals, anhydrides, carbides, hydrides, sodium hydrosulfite, and similar chemicals. An example of the chemical reaction of sodium metal with water is:

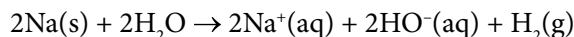

The heat generated by this reaction is generally sufficient to ignite the hydrogen gas ( $\text{H}_2$ ) that is evolved in the reaction and can result in an explosion, depending on the amount and surface area of the alkali metal. Elemental potassium and cesium are particularly dangerous in this regard.

Another example of a dangerous-when-wet chemical is aluminum phosphide which reacts with water to release

highly toxic phosphine gas,  $\text{PH}_3$ . This chemical reaction is commercially exploited to kill moles and related pests:

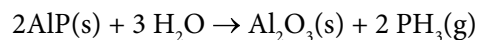

Thus, it is critical that water reactive substances be stored in dry areas and kept off the floor by the use of pallets or rack storage. Dangerous-when-wet chemicals should never be stored directly beneath active water sprinklers and should be isolated by a waterproof or water-resistant barrier (e.g., plastic sheeting or a watertight secondary container) to protect the materials from water in the event the sprinkler system is activated elsewhere in the facility.

Water-reactive chemicals pose serious safety and health risks. The MSDS (material safety data sheet) will provide information about these risks as well as the precautions that should be taken when handling the material. Laboratory personnel should ensure that water-reactive materials are well marked so that firefighters and other personnel are aware of the danger in an emergency situation and be sure to have the correct type of fire extinguisher on hand.



# Chemometrics

The term *chemometrics* (the use of statistical and mathematical techniques to analyze chemical data) denotes a very broad set of mathematical and statistical methods that can be applied to complex data sets obtained from chemical analysis.

In petroleum technology, common applications include identification of fuel type, prediction of fuel properties (e.g., density, viscosity, flash point, freeze point, and octane or cetane number), determination of chemical content (e.g., percent aromatic, olefin, aliphatic, and metals), and quality or process control. One of the simplest and most versatile chemometric methods – *principal component analysis* (PCA)

which, when applied to a set of chromatograms obtained for a series of aviation fuels, can be used to identify fuel type based on pattern recognition.

Used correctly, chemometrics represents a useful set of mathematical and statistical tools that, when applied to complex chemical data, can provide identification, property prediction, determination of chemical content, and quality control. However, it must be recognized that, as with any mathematical model, the models derived from chemometrics are only as good as the data used and inaccuracies in the data will result in poor predictive models.





# Clausius Equation and Clausius-Clapeyron Equation

*Clausius equation:*

$$\frac{dp}{dT} = \frac{\Delta H_m}{(V - v)T}$$

where  $p$  = pressure  
 $T$  = absolute temperature  
 $\Delta H_m$  = molal heat of vaporization  
 $V$  = molar vapor volume  
 $v$  = molar liquid volume

*Clausius-Clapeyron equation:*

In this equation, the volume of liquid can be ignored and the ideal gas law holds:

$$\frac{d(\ln p)}{dT} = \frac{1}{p} \frac{dp}{dT} = \frac{\Delta H_m}{RT^2}$$

and with  $\Delta H_m = \text{constant}$ , integration yields

$$\ln \frac{p_2}{p_1} = \frac{\Delta H_m}{R} \left[ \frac{T_2 - T_1}{T_1 T_2} \right]$$

where  $p$  = pressure  
 $T$  = absolute temperature  
 $\Delta H_m$  = molal heat of vaporization  
 $V$  = molar vapor volume  
 $v$  = molar liquid volume



# Coal – General Properties

Coal is a readily combustible organic rock containing more than 50% w/w of carbonaceous material, formed from compaction and indurations of variously altered plant remains similar to those in peat.

Lignite increases in maturity by becoming darker and harder and is then classified as sub-bituminous coal. After a continuous process of burial and alteration, chemical and physical changes occur until the coal is classified as bituminous – dark and hard coal. Bituminous coal ignites easily and burns long with a relatively long flame. If improperly fired bituminous coal is characterized with excess smoke and soot. Anthracite is very hard and shiny. Anthracite coal creates a steady and clean flame and is preferred for domestic heating and burns longer with more heat than the other types.

**Table** General properties.

Typical Sulfur Content in Coal
Anthracite Coal: 0.6–0.77 weight %
Bituminous Coal: 0.7–4.0 weight %
Lignite Coal: 0.4 weight %
Typical Moisture Content in Coal
Anthracite Coal: 2.8–16.3 weight %
Bituminous Coal: 2.2–15.9 weight %
Lignite Coal: 39 weight %
Typical Fixed Carbon Content in Coal
Anthracite Coal: 80.5–85.7 weight %
Bituminous Coal: 44.9–78.2 weight %
Lignite Coal: 31.4 weight %
Typical Bulk Density of Coal
Anthracite Coal: 50–58 (lb/ft <sup>3</sup> ), 800–929 (kg/m <sup>3</sup> )
Bituminous Coal: 42–57 (lb/ft <sup>3</sup> ), 673–913 (kg/m <sup>3</sup> )
Lignite Coal: 40–54 (lb/ft <sup>3</sup> ), 641–865 (kg/m <sup>3</sup> )
Typical Ash Content in Coal
Anthracite Coal: 9.7–20.2 weight %
Bituminous Coal: 3.3–11.7 weight %
Lignite Coal: 4.2 weight %



## Coke Yield from Conradson Carbon

A series of relationships have been developed that allow estimation of the yield of various products from the yield of coke in the Conradson Carbon standard test method.

However, caution is advised since these relationships (developed for a particular residuum) may not be applicable to all crude oil resids. In addition, the relationships do not take into account the use of blended feedstocks that is now standard in modern refineries. In this respect, the equations

do not account for the intermolecular relationships that can occur between the constituents of each component of the blend – this includes not only molecular interference between the constituents of the blend components but also the potential for incompatibility and the separation of some constituents of a blend component as a separate phase. It would be necessary to develop a much more complex matrix for blends in order for the data to be meaningful to the refiner.

**Table** Coke yields derived from conradson carbon.\*

Coke, % w/w	1.6 (% w/w Conradson carbon)
Gas (C <sub>4</sub> ), % w/w	7.8 + 0.144 (% w/w Conradson carbon)
Naphtha, % w/w	11.29 + 0.343 (% w/w Conradson carbon)
Naphtha, % v/v	(naphtha, % w/w)[186.5/(131.5 + °API)]
Gas oil, % w/w	100 - % w/w coke - % w/w gas - % w/w naphtha
Gas oil, % v/v	(gas oil, % w/w)[155.5/(131.5 + °API)]

\*Estimates only and the outcome is not guaranteed to be accurate from every feedstock.



# Common Acronyms

**Table** Common acronyms used in the petroleum and natural gas industries.

<b>Acronym</b>	<b>Description</b>
AC	Alternating Current
AGA	American Gas Association
API	American Petroleum Institute
CCR	Central Control Room
CMS	Condition Monitoring Systems
CSP	Collector and Separation Platform
DC	Direct Current
DYNPOS	Dynamic Positioning (of rigs and ships)
E&P	Exploration and Production
EOR	Enhanced Oil Recovery
ESD	Emergency Shutdown System
ESP	Electric Submerged Pump
F&G	Fire & Gas System
FPSO	Floating Production Storage and Offloading
GB(S)	Gravity Base Structure
GOR	Gas Oil Ratio from the well
GOSP	Gas Oil Separation Plant
GTP	Gas Treatment Platform
HP	High Pressure
HPU	Hydraulic Power Unit (topside utility for subsea)
HVAC	Heat Ventilation and Air Conditioning
IR	Infrared
ISO	International Standards Organization
K-Mass Flow	Coriolis-type Mass Flow Meter

<b>Acronym</b>	<b>Description</b>
LNG	Liquid Natural Gas (e.g., Methane)
LP	Low Pressure
LPG	Liquefied Petroleum Gas (e.g. Propane)
MCC	Motor Control Centre
MTBF	Mean Time Between Failure
NGL	Natural Gas Liquids, Condensates, see also LPG
PCP	Progressive Cavity Pump
PD-Meter	Positive Displacement Meter
PGP	Power Generation Platform
PID	Proportional Integral Derivate control algorithm
PIMS	Production Information Management System
PoC	Pump of Controller (for artificial lift)
POSMOOR	Position Mooring for a Floating Facility
PSD	Process Shutdown System
ROV	Remote Operated Vehicle (for subsea workover)
RTU	Remote Terminal Unit
SAS	Safety and Automation System
SCADA	Supervisory Control and Data Acquisition
TIP	Tie-In Platform
TLP	Tension Leg Platform
UMS	Unmanned Machinery Space Classification (marine = E0)
URF	Umbilicals, Risers, and Flowlines
UV	Ultraviolet
WHP	Wellhead Platform





## Common Names of Selected Chemical Compounds

Common Name	Chemical Name	Formula
Baking soda	sodium hydrogen carbonate sodium bicarbonate	$\text{NaHCO}_3$
Bleach	sodium hypochlorite hydrogen peroxide sodium perborate	$\text{NaClO}$ $\text{H}_2\text{O}_2$ $\text{NaBO}_3$
Borax	sodium tetraborate decahydrate	$\text{Na}_2\text{B}_4\text{O}_7 \cdot 10\text{H}_2\text{O}$
Brimstone	sulfur	S
Cream of tartar	potassium hydrogen tartrate	$\text{KHC}_4\text{H}_4\text{O}_6$
Epsom salt	magnesium sulfate heptahydrate	$\text{MgSO}_4 \cdot 7\text{H}_2\text{O}$
Freon	dichlorodifluoromethane	$\text{CF}_2\text{Cl}_2$
Galena	lead (II) sulfide	PbS
Grain alcohol	ethanol	$\text{C}_2\text{H}_5\text{OH}$
Graphite	carbon	C
Gypsum	calcium sulfate dihydrate	$\text{CaSO}_4 \cdot 2\text{H}_2\text{O}$
Hypo	sodium thiosulfate	$\text{Na}_2\text{S}_2\text{O}_3$
Laughing gas	dinitrogen oxide	$\text{N}_2\text{O}$
Lime	calcium oxide	CaO
Limestone	calcium carbonate	$\text{CaCO}_3$
Lye	sodium hydroxide	NaOH
Marble	calcium carbonate	$\text{CaCO}_3$

Common Name	Chemical Name	Formula
MEK	methyl ethyl ketone	$\text{CH}_3\text{COC}_2\text{H}_5$
Milk of magnesia	magnesium hydroxide	$\text{Mg}(\text{OH})_2$
Muriatic acid	hydrochloric acid	HCl
Oil of vitriol	sulfuric acid	$\text{H}_2\text{SO}_4$
Plaster of paris	calcium sulfate hemi- hydrate	$\text{CaSO}_4 \cdot 0.5\text{H}_2\text{O}$
Potash	potassium carbonate	$\text{K}_2\text{CO}_3$
Iron pyrite (fool's gold)	iron disulfide	$\text{FeS}_2$
Quartz	silicon dioxide	$\text{SiO}_2$
Quicksilver	mercury	Hg
Rubbing alcohol	isopropyl alcohol	$(\text{CH}_3)_2\text{CHOH}$
Sal ammoniac	ammonium chloride	$\text{NH}_4\text{Cl}$
Salt	sodium chloride	NaCl
Salt substitute	potassium chloride	KCl
Saltpeter	potassium nitrate	$\text{KNO}_3$
Slaked lime	calcium hydroxide	$\text{Ca}(\text{OH})_2$
Sugar	sucrose	$\text{C}_{12}\text{H}_{22}\text{O}_{11}$
TSP trisodium phosphate	sodium phosphate	$\text{Na}_3\text{PO}_4$
Washing soda	sodium carbonate decahydrate	$\text{Na}_2\text{CO}_3 \cdot 10\text{H}_2\text{O}$
Wood alcohol	methyl alcohol	$\text{CH}_3\text{OH}$



# Common Unit Conversions

<b>Gas Constant</b> 0.082 liter-atm/mole K 62.36 liter-mm Hg/mole K 8.314 Joule/g-mole K 1.314 atm-ft <sup>3</sup> /lb-mole K 1.987 cal/g-mole K 1.987 Btu/lb-mole °R 0.73 atm-ft <sup>3</sup> /lb-mole °R 10.73 psi-ft <sup>3</sup> /lb-mole °R 1545 ft-lb/lb-mole °R	<b>Volume</b> 1 ft <sup>3</sup> = 28.316 liter = 7.481 gal 1 in. <sup>3</sup> = 16,39 cc = $5.787 \times 10^{-4}$ ft <sup>3</sup> 1 gal = 3.785 liter = 8.34 lb H <sub>2</sub> O 1 m <sup>3</sup> = 35.32 ft <sup>3</sup> = 264.2 gal	<b>Density</b> 1g/cm <sup>3</sup> = 1000 kg/m <sup>3</sup> = 62.428 lb/ft <sup>3</sup> = 8.345 lb/gal = 0.03613 lb/in. <sup>3</sup>
<b>Length</b> 1 mile = 1609 m = 5280 ft 1 ft = 30.48 cm = 12 in. 1 in. = 2.54 cm 1 m = 3.2808 ft = 39.37 in. 1 nm = 10 <sup>-9</sup> m = 10 Å	<b>Viscosity</b> 1 poise = $6.7197 \times 10^{-2}$ lb <sub>m</sub> /ft-sec = $2.0886 \times 10^{-3}$ lb <sub>f</sub> -sec/ft <sup>2</sup> = $2.4191 \times 10^2$ lb <sub>m</sub> /ft-hr = 1 g/cm-sec	<b>Conversion Factor</b> 1 cal/g-mole = 1.8Btu/lb-mole 1 amu = $1.66063 \times 10^{-24}$ g 1 eV = $1.6022 \times 10^{-12}$ erg 1 radian = 57.3° 1 cm/sec = 1.9685 ft/min 1 rpm = 0.10472 radian/sec
<b>Pressure</b> 1 atm = 101325 N/m <sup>2</sup> = 14.696 psi = 760 mmHg = 29.921 in.Hg (32 °F) = 33.91 ftH <sub>2</sub> O (39.1 °F) = 2116.2 lb <sub>f</sub> /ft <sup>2</sup> = 1.0133 bar = 1033.3 g/cm <sup>2</sup>	<b>Constant</b> h = $6.6262 \times 10^{-27}$ erg-sec k = $1.38062 \times 10^{-16}$ erg/K N <sub>0</sub> = $6.022169 \times 10^{23}$ C = $2.997925 \times 10^{10}$ cm/sec F = 96487 coul/eq e = $1.60219 \times 10^{-19}$ coul g = 980.665 cm/sec <sup>2</sup> = 32.174 ft/sec <sup>2</sup>	<b>Mass</b> 1 kg = 2.2046 lb 1 lb = 453.59 g 1 ton = 2000 lb = 907.2 kg 1 B ton = 2240 lb = 1016 kg 1 tonne = 2205 lb = 1000 kg 1 slug = 32.2 lb = 14.6 kg

<p><b>Area</b>  <math>1 \text{ m}^2 = 10.76 \text{ ft}^2 = 1550 \text{ in.}^2</math>  <math>1 \text{ ft}^2 = 929.0 \text{ cm}^2</math></p>	<p><b>Power</b>  <math>1 \text{ HP} = 550 \text{ ft-lb}_f/\text{sec}</math>  <math>= 745.48 \text{ watt}</math>  <math>1 \text{ Btu/hr} = 0.293 \text{ watt}</math></p>	<p><b>Force</b>  <math>1 \text{ N} = 1 \text{ kg-m}/\text{sec}^2</math>  <math>= 10^5 \text{ dyne}</math>  <math>= 0.22481 \text{ lb}_f</math>  <math>= 7.233 \text{ lb}_m\text{-ft}/\text{sec}^2</math></p>
<p><b>Transfer Coefficient</b>  <math>1 \text{ Btu/hr-ft}^2 \text{ } ^\circ\text{F}</math>  <math>= 5.6784 \text{ Joule}/\text{sec-m}^2\text{K}</math>  <math>= 4.8825 \text{ Kcal}/\text{hr-m}^2 \text{ K}</math>  <math>= 0.45362 \text{ Kcal}/\text{hr-ft}^2 \text{ K}</math>  <math>= 1.3564 \times 10^{-4} \text{ cal}/\text{sec-cm}^2 \text{ K}</math>  <math>1 \text{ lb}/\text{hr-ft}^2</math>  <math>= 1.3562 \times 10^3 \text{ kg}/\text{sec-m}^2</math>  <math>= 4.8823 \text{ kg}/\text{hr-m}^2</math>  <math>= 0.45358 \text{ kg}/\text{hr-ft}^2</math>  <math>1 \text{ cal}/\text{g } ^\circ\text{C} = 1 \text{ Btu}/\text{lb}_m \text{ } ^\circ\text{F}</math>  <math>= 1 \text{ Pcu}/\text{lb}_m \text{ } ^\circ\text{C}</math>  <math>1 \text{ Btu}/\text{hr-ft } ^\circ\text{F} = 1.731 \text{ W}/\text{m K}</math>  <math>= 1.4882 \text{ kcal}/\text{hr-m K}</math></p>	<p><b>Energy &amp; Work</b>  <math>1 \text{ cal} = 4.184 \text{ Joule}</math>  <math>1 \text{ Btu} = 1055.1 \text{ Joule}</math>  <math>= 252.16 \text{ cal}</math>  <math>1 \text{ HP-hr} = 2684500 \text{ Joule}</math>  <math>= 641620 \text{ cal}</math>  <math>= 2544.5 \text{ Btu}</math>  <math>1 \text{ KW-hr} = 3.6 \times 10^6 \text{ Joule}</math>  <math>= 860565 \text{ cal}</math>  <math>= 3412.75 \text{ Btu}</math>  <math>1 \text{ l-atm} = 24.218 \text{ cal}</math>  <math>1 \text{ ft-lb}_f = 0.3241 \text{ cal}</math>  <math>1 \text{ Pcu} = 453.59 \text{ cal}</math>  <math>1 \text{ kg-m} = 2.3438 \text{ cal}</math></p>	<p><b>Stress</b>  <math>1 \text{ MPa} = 145 \text{ psi}</math>  <math>1 \text{ MPa} = 0.102 \text{ kg}/\text{mm}^2</math>  <math>1 \text{ Pa} = 10 \text{ dynes}/\text{cm}^2</math>  <math>1 \text{ kg}/\text{mm}^2 = 1422 \text{ psi}</math>  <math>1 \text{ psi} = 6.90 \times 10^{-3} \text{ MPa}</math>  <math>1 \text{ kg}/\text{mm}^2 = 9.806 \text{ MPa}</math>  <math>1 \text{ dyne}/\text{cm}^2 = 0.10 \text{ Pa}</math>  <math>1 \text{ psi} = 7.03 \times 10^{-4} \text{ kg}/\text{mm}^2</math>  <math>1 \text{ psi in.}^{1/2} = 1,099 \times 10^{-3} \text{ MPa m}^{1/2}</math>  <math>1 \text{ MPa m}^{1/2} = 910 \text{ psi in.}^{1/2}</math></p>

## Commonly Used Constants

Atomic mass	$m_u = 1.660\,5402 \times 10^{-27}$
Avogadro's number	$N = 6.0221\,367 \times 10^{23} \text{ mol}^{-1}$
Boltzmann's constant	$k = 1.380658 \times 10^{-23} \text{ J} \cdot \text{K}^{-1}$
Elementary charge	$e = 1.60217733 \times 10^{-19} \text{ C}$
Faraday's constant	$F = 9.6485309 \times 10^4 \text{ C} \cdot \text{mol}^{-1}$
Gas (molar) constant	$R = k \cdot N = 8.314510 \text{ J} \cdot \text{mol}^{-1} \cdot \text{K}^{-1}$ $= 0.08205783 \text{ L} \cdot \text{atm} \cdot \text{mol}^{-1} \cdot \text{K}^{-1}$
Gravitational acceleration	$g = 9.80665 \text{ m} \cdot \text{s}^{-2}$
Molar volume of an ideal gas at 1 atm and 25 °C	$\bar{V}_{\text{ideal gas}} = 24.465 \text{ L} \cdot \text{mol}^{-1}$
Permittivity of vacuum	$= \epsilon_0 = 8.854187 \times 10^{-12} \text{ C} \cdot \text{V}^{-1} \cdot \text{m}^{-1}$
Planck's constant	$h = 6.6260755 \times 10^{-34} \text{ J} \cdot \text{s}$
Zero of the Celsius scale	$0^\circ\text{C} = 273.15 \text{ K}$



# Compressibility

The compressibility factor  $Z$  is a dimensionless factor independent of the quantity of gas and determined by the character of the gas, the temperature, and pressure (see Table for meaning of symbols):

$$Z = PV/NRT + MPV/mRT$$

A knowledge of the compressibility factor means that the density,  $\rho$ , is also known from the relationship:

$$\rho = PM/ZRT$$

The isothermal gas compressibility, which is given the symbol  $c_g$ , is a useful concept which will be used extensively in determining the compressible properties of the reservoir. The isothermal compressibility is also called the bulk modulus of elasticity. Gas usually is the most compressible medium in the reservoir. However, care should be taken so that it not be confused with the gas deviation factor,  $z$ , which is sometimes called the super-compressibility factor.

The isothermal gas compressibility is defined as:

$$c_g = -\frac{1}{V_g} \left( \frac{\partial V_g}{\partial p} \right)_T$$

An expression in terms of  $z$  and  $p$  for the compressibility can be derived from the real gas law:

$$\left( \frac{\partial V_g}{\partial p} \right)_T = \frac{nRT}{p} \left( \frac{\partial z}{\partial p} \right)_T - \frac{znRT}{p^2} = \left( \frac{znR'T}{p} \right) \frac{1}{z} \frac{dz}{dp} - \left( \frac{znR'T}{p} \right) \times \frac{1}{p}$$

From the real gas equation of state:

$$\frac{1}{V_g} = \frac{p}{znRT}$$

Hence

$$\frac{1}{V_g} \left( \frac{\partial V_g}{\partial p} \right)_T = \frac{1}{z} \frac{dz}{dp} - \frac{1}{p}$$

For gases at low pressures the second term is small and the compressibility can be approximated by  $c_g \approx 1/p$ . Equation 2 is not particularly convenient for determining the gas compressibility because  $z$  is not actually a function of  $p$  but of  $p_r$ . However, equation 2 can be made convenient in terms of a dimensionless pseudo-reduced gas compressibility defined as:

$$c_r = c_g p_{pc}$$

Multiplying equation 2 through by the pseudo-critical pressure,

$$c_r = c_g p_{pc} = \frac{1}{p_r} - \frac{1}{z} \left( \frac{\partial z}{\partial p_r} \right)_{T_r}$$

The expression for calculating the pseudo-reduced compressibility is:

$$c_r = \frac{1}{p_r} - \frac{0.27}{z^2 T_r} \left( \frac{(\partial z / \partial p_r)_{T_r}}{1 + \left( \frac{\rho_r}{z} \right) \left( \frac{\partial z}{\partial \rho_r} \right)_{T_r}} \right)$$

There is also a close relationship between the formation volume factor of gas and the isothermal gas compressibility. It can be easily shown that:

$$c_g = -\frac{1}{B_g} \left( \frac{\partial B_g}{\partial p} \right)_T$$

**Table** symbols used in determining the compressibility factor.

	<b>Field units</b>	<b>SI units</b>
P = absolute pressure	psia	kPa
V = volume	ft <sup>3</sup>	m <sup>3</sup>
n = moles	m/M	m/M
m = mass	lb	kg
M = molecular mass	lb/lb mole	kg/kmole
T = absolute temperature	°R	K
R = universal gas constant	10.73 [psia • ft <sup>3</sup> /°R • lb mole mole]	8.3145 [kPa m <sup>3</sup> /kmol • K]
$\rho$ = density	slug/ft <sup>3</sup>	kg/m <sup>3</sup>



# Coning

Coning is the term used to describe the mechanism that underlies the upward movement of water and/or the downward movement of gas into the perforations of a producing

well. This phenomenon can seriously impact well productivity as well as the depletion of the overall recovery efficiency of a reservoir.



# Conversion Charts

## Length

From	To	Multiply by
Kilometers (km)	Miles (mi)	0.62
Kilometers (km)	Feet (ft)	3280.8
Meters (m)	Feet (ft)	3.28
Centimeters (cm)	Inches (in)	0.39
Millimeters (mm)	Inches (in)	0.039
Inches (in)	Meters (m)	0.0254
Inches (in)	Centimeters (cm)	2.54
Inches (in)	Millimeters (mm)	25.40
Feet (ft)	Meters (m)	0.30
Yards (yd)	Meters (m)	0.91
Yards (yd)	Kilometers (km)	0.00091
Miles (mi)	Kilometers (km)	1.61

## Volume

From	To	Multiply by
Liters (l)	Quarts (qt)	1.057
Liters (l)	Gallons (gal)	0.264
Milliliters (ml)	Cups (c)	0.0042
Milliliters (ml)	Ounces (oz)	0.0338
Ounces (oz)	Milliliters (ml)	29.57
Cups (c)	Milliliters (ml)	236.6
Quarts (qt)	Liters (l)	0.95
Gallons (gal)	Liters (l)	3.785

## Mass

From	To	Multiply by
Kilogram (kg)	Tons (ton)	0.0011
Kilogram (kg)	Pounds (lb)	2.2046
Grams (g)	Ounces (oz)	0.035
Grams (g)	Pounds (lb)	0.002205
Milligrams (mg)	Ounces (oz)	0.000035
Ounces (oz)	Milligrams (mg)	28350
Ounces	Grams (g)	28.35

## Temperature

From	To	Conversion
Fahrenheit (F)	Celsius (C)	$(\text{Temperature (F)} - 32) * 5/9$
Celsius (C)	Fahrenheit (F)	$(\text{Temperature (C)} * 9) + 32$



# Conversion Factors

To Convert From	To	Multiply by
Area		
Acres	Sq feet	$4.356 \times 4$
Acres	Sq kilometers	$4.0469 \times 10^{-3}$
Acres	Sq meters	$4.0469 \times 10^3$
Acres	Sq miles (statute)	$1.5625 \times 10^{-3}$
Acres	Sq yards	$4.84 \times 10^3$
Sq feet	Acres	$2.2957 \times 10^{-5}$
Sq feet	Sq cm	929.03
Sq feet	Sq inches	144.0
Sq feet	Sq meters	0.092903
Sq feet	Sq miles	$3.587 \times 10^{-8}$
Sq feet	Sq yards	0.111111
Sq inches	Sq feet	$6.9444 \times 10^{-3}$
Sq inches	Sq meters	$6.4516 \times 10^{-4}$
Sq inches	Sq mm	645.16
Sq kilometers	Acres	247.1
Sq kilometers	Sq feet	$1.0764 \times 10^7$
Sq kilometers	Sq meters	$1.0 \times 10^6$
Sq kilometers	Sq miles	0.386102
Sq kilometers	Sq yards	$1.196 \times 10^6$
Sq meters	Sq cm	$1.0 \times 10^4$
Sq meters	Sq feet	10.764
Sq meters	Sq inches	$1.55 \times 10^3$
Sq meters	Sq kilometers	$1.0 \times 10^{-6}$
Sq meters	Sq miles	$3.861 \times 10^{-7}$
Sq meters	Sq mm	$1.0 \times 10^6$
Sq meters	Sq yards	1.196
Sq miles	Acres	640.0
Sq miles	Sq feet	$2.7878 \times 10^7$

To Convert From	To	Multiply by
Sq miles	Sq kilometers	2.590
Sq miles	Sq meters	$2.59 \times 10^6$
Sq miles	Sq yards	$3.0976 \times 10^6$
Sq yards	Acres	$2.0661 \times 10^{-4}$
Sq yards	Sq cm	$8.3613 \times 10^3$
Sq yards	Sq ft	9.0
Sq yards	Sq inches	$1.296 \times 10^3$
Sq yards	Sq meters	0.83613
Sq yards	Sq miles	$3.2283 \times 10^{-7}$
Density		
Dynes/cu cm	Grams/cu cm	$1.0197 \times 10^{-3}$
Grains/cu foot	Grams/cu meter	2.28835
Grams/cu cm	Dynes/cu cm	980.665
Grams/cu cm	Grains/milliliter	15.433
Grams/cu cm	Grains/milliliter	1.0
Grams/cu cm	Pounds/cu inch	1.162
Grams/cu cm	Pounds/cu foot	62.428
Grams/cu cm	Pounds/cu inch	0.036127
Grams/cu cm	Pounds/gal (Brit.)	10.022
Grams/cu cm	Pounds/gal (U. S., dry)	9.7111
Grams/cu cm	Pounds/gal (U. S., liq.)	8.3454
Grams cu/meter	Grains/cu foot	0.4370
Grams/liter	Pounds/gal (U. S.)	$8.345 \times 10^{-3}$
Kilograms cu/meter	Grams/cu cm	0.001
Kilograms cu/meter	Pounds/cu ft	0.0624
Kilograms cu/meter	Pounds/cu in	$3.613 \times 10^{-5}$
Pounds/cu foot	Grams/cu cm	0.016018
Pounds/cu foot	kg/cu meter	16.018
Pounds/cu inch	Grams/cu cm	27.68

(Continued)

To Convert From	To	Multiply by
Pounds/cu inch	Grams/liter	27.681
Pounds/cu inch	kg/cu meter	$2.768 \times 10^4$
Pounds/gal (U. S., liq.)	Grams/cu cm	0.1198
Pounds/gal (U. S., liq.)	Pounds/cu ft	7.4805
Energy		
Btu	Cal. m (IST.)	251.83
Btu	Ergs	$1.05435 \times 10^{10}$
Btu	Foot-pounds	777.65
Btu	Hp-hours	$3.9275 \times 10^{-4}$
Btu	Joules (Int.)	1054.2
Btu	kg-meters	107.51
Btu	kW-hours (Int.)	$2.9283 \times 10^{-4}$
Btu/hr	Cal. kg/hr	0.252
Btu/hr	Ergs/sec	$2.929 \times 10^6$
Btu/hr	Foot-pounds/hr	777.65
Btu/hr	Horsepower (mechanical)	$3.9275 \times 10^{-4}$
Btu/hr	Horsepower (boiler)	$2.9856 \times 10^{-5}$
Btu/hr	Horsepower (electric)	$3.926 \times 10^{-4}$
Btu/hr	Horsepower (metric)	$3.982 \times 10^{-4}$
Btu/hr	Kilowatts	$2.929 \times 10^{-4}$
Btu/lb	Foot-pounds/lb	777.65
Btu/lb	Hp-hr/lb	$3.9275 \times 10^{-4}$
Btu/lb	Joules/gram	2.3244
Calories, kg (mean)	Btu (IST.)	3.9714
Calories, kg (mean)	Ergs	$4.190 \times 10^{10}$
Calories, kg (mean)	Foot-pounds	$3.0904 \times 10^3$
Calories, kg (mean)	Hp-hours	$1.561 \times 10^{-3}$
Calories, kg (mean)	Joules	$4.190 \times 10^3$
Calories, kg (mean)	kg-meters	427.26
Calories, kg (mean)	kW-hours (Int.)	$1.1637 \times 10^{-3}$
Ergs	Btu	$9.4845 \times 10^{-11}$
Ergs	Font-poundals	$2.373 \times 10^{-6}$
Ergs	Foot-pounds	$7.3756 \times 10^{-8}$
Ergs	Joules (Int.)	$9.99835 \times 10^{-8}$
Ergs	kW-hours	$2.7778 \times 10^{-14}$
Ergs	kg-meters	$1.0197 \times 10^{-8}$
Foot-pounds	Btu (IST.)	$1.2851 \times 10^{-3}$
Foot-pounds	Cal. kg (IST.)	$3.2384 \times 10^{-4}$
Foot-pounds	Ergs	$1.3558 \times 10^7$
Foot-pounds	Foot-poundals	32.174

To Convert From	To	Multiply by
Foot-pounds	Hp-hours	$5.0505 \times 10^{-7}$
Foot-pounds	Joules	1.3558
Foot-pounds	kg-meters	0.138255
Foot-pounds	kW-hours (Int.)	$3.76554 \times 10^{-7}$
Foot-pounds	Newton-meters	1.3558
Foot-pounds/hr	Btu/min	$2.1432 \times 10^{-5}$
Foot-pounds/hr	Ergs/min	$2.2597 \times 10^5$
Foot-pounds/hr	Horsepower (mechanical)	$5.0505 \times 10^{-7}$
Foot-pounds/hr	Horsepower (metric)	$5.121 \times 10^{-7}$
Foot-pounds/hr	Kilowatts	$3.766 \times 10^{-7}$
Horsepower (mechanical)	Btu (mean)/hr	$2.5425 \times 10^3$
Horsepower (mechanical)	Ergs/sec	$7.457 \times 10^9$
Horsepower (mechanical)	Foot-pounds/hr	$1.980 \times 10^6$
Horsepower (mechanical)	Horsepower (boiler)	0.07602
Horsepower (mechanical)	Horsepower (electric)	0.9996
Horsepower (mechanical)	Horsepower (metric)	1.0139
Horsepower (mechanical)	Joules/sec	745.70
Horsepower (mechanical)	Kilowatts (Int.)	0.74558
Horsepower (boiler)	Btu (mean)/hr	$3.3446 \times 10^4$
Horsepower (boiler)	Ergs/sec	$9.8095 \times 10^{10}$
Horsepower (boiler)	Foot-pounds/min	$4.341 \times 10^5$
Horsepower (boiler)	Horsepower (mechanical)	13.155
Horsepower (boiler)	Horsepower (electric)	13.15
Horsepower (boiler)	Horsepower (metric)	13.337
Horsepower (boiler)	Joules/sec	$9.8095 \times 10^3$
Horsepower (boiler)	Kilowatts	9.8095
Horsepower (electric)	Btu (mean)/hr	$2.5435 \times 10^3$
Horsepower (electric)	Cal. kg/hr	641.87
Horsepower (electric)	Ergs/sec	$7.46 \times 10^9$
Horsepower (electric)	Foot-pounds/min	$3.3013 \times 10^4$
Horsepower (electric)	Horsepower (boiler)	0.07605
Horsepower (electric)	Horsepower (metric)	1.0143
Horsepower (electric)	Joules/sec	746.0
Horsepower (electric)	Kilowatts	0.746
Horsepower (metric)	Btu (mean)/hr	$2.5077 \times 10^3$

(Continued)

To Convert From	To	Multiply by
Horsepower (metric)	Ergs/sec	$7.355 \times 10^9$
Horsepower (metric)	Foot-pounds/min	$3.255 \times 10^4$
Horsepower (metric)	Horsepower (mechanical)	0.98632
Horsepower (metric)	Horsepower (boiler)	0.07498
Horsepower (metric)	Horsepower (electric)	0.9859
Horsepower (metric)	kg-meters/sec	75.0
Horsepower (metric)	Kilowatts	0.7355
Horsepower-hours	Btu (mean)	$2.5425 \times 10^3$
Horsepower-hours	Foot-pounds	$1.98 \times 10^6$
Horsepower-hours	Joules	$2.6845 \times 10^6$
Horsepower-hours	kg-meters	$2.73745 \times 10^5$
Horsepower-hours	kW-hours	0.7457
Joules (Int.)	Btu (IST.)	$9.4799 \times 10^{-4}$
Joules (Int.)	Ergs	$1.0002 \times 10^7$
Joules (Int.)	Foot-poundals	12.734
Joules (Int.)	Foot-pounds	0.73768
Joules (Int.)	kW-hours	$2.778 \times 10^{-7}$
Joules (Int.)/sec	Btu (mean)/min	0.05683
Joules (Int.)/sec	Cal. kg/min	0.01434
Joules (Int.)/sec	Horsepower	$1.341 \times 10^{-3}$
Kilogram-meters	Btu (mean)	$9.2878 \times 10^{-3}$
Kilogram-meters	Cal. kg (mean)	$2.3405 \times 10^{-3}$
Kilogram-meters	Ergs	$9.80665 \times 10^7$
Kilogram-meters	Foot-poundals	232.715
Kilogram-meters	Foot-pounds	7.233
Kilogram-meters	Hp-hours	$3.653 \times 10^{-6}$
Kilogram-meters	Joules (Int.)	9.805
Kilogram-meters	kW-hours	$2.724 \times 10^{-6}$
Kilogram-meters/sec	Watts	9.80565
Kilowatts (Int.)	Btu (IST.)/hr	$3.413 \times 10^3$
Kilowatts (Int.)	Cal. kg (IST.)/hr	860.0
Kilowatts (Int.)	Ergs /sec	$1.002 \times 10^{10}$
Kilowatts (Int.)	Foot-poundals/min	$1.424 \times 10^6$
Kilowatts (Int.)	Foot-pounds/min	$4.4261 \times 10^4$
Kilowatts (Int.)	Horsepower (mechanical)	1.341
Kilowatts (Int.)	Horsepower (boiler)	0.10196
Kilowatts (Int.)	Horsepower (electric)	1.3407
Kilowatts (Int.)	Horsepower (metric)	1.3599
Kilowatts (Int.)	Joules (Int.)/hr	$3.6 \times 10^6$
Kilowatts (Int.)	kg-meters/hr	$3.36716 \times 10^5$
Kilowatt-hours (Int.)	Btu (mean)	$3.41 \times 10^3$
Kilowatt-hours (Int.)	Foot-pounds	$2.6557 \times 10^6$

To Convert From	To	Multiply by
Kilowatt-hours (Int.)	Hp-hours	1.341
Kilowatt-hours (Int.)	Joules (Int.)	$3.6 \times 10^6$
Kilowatt-hours (Int.)	kg-meters	$3.6716 \times 10^5$
Newton-meters	Gram-cm	$1.01972 \times 10^4$
Newton-meters	kg-meters	0.101972
Newton-meters	Pound-feet	0.73756
Force		
Dynes	Newtons	$1.0 \times 10^{-5}$
Dynes	Poundals	$7.233 \times 10^{-5}$
Dynes	Pounds	$2.248 \times 10^{-6}$
Newtons	Dynes	$1.0 \times 10^{-5}$
Newtons	Pounds (avdp.)	0.22481
Poundals	Dynes	$1.383 \times 10^4$
Poundals	Newtons	0.1383
Poundals	Pounds (avdp.)	0.03108
Pounds (advp.)	Dynes	$4.448 \times 10^5$
Pounds (advp.)	Newtons	4.448
Pounds (advp.)	Poundals	32.174
Length		
Feet	Centimeters	30.48
Feet	Inches	12
Feet	Kilometers	$3.048 \times 10^{-4}$
Feet	Meters	0.3048
Feet	Miles (statute)	$1.894 \times 10^{-4}$
Inches	Centimeters	2.540
Inches	Feet	0.08333
Inches	Kilometers	$2.54 \times 10^{-5}$
Inches	Meters	0.0254
Kilometers	Feet	$3.2808 \times 10^3$
Kilo meters	Meters	1000
Kilometers	Miles (statute)	0.62137
Kilometers	Yards	$1.0936 \times 10^3$
Meters	Feet	3.2808
Meters	Inches	39.370
Micrometers	Angstrom units	$1.0 \times 10^4$
Micrometers	Centimeters	$1.0 \times 10^{-3}$
Micrometers	Feet	$3.2808 \times 10^{-6}$
Micrometers	Inches	$3.9370 \times 10^{-5}$
Micrometers	Meters	$10 \times 10^{-6}$
Micrometers	Millimeters	0.0001
Micrometers	Nanometers	1000
Miles (statute)	Feet	5280
Miles (statute)	Kilometers	1.6093

(Continued)

To Convert From	To	Multiply by
Miles (statute)	Meters	$1.6093 \times 10^3$
Miles (statute)	Yards	1760
Millimeters	Angstrom units	$1.0 \times 10^7$
Millimeters	Centimeters	0.1
Millimeters	Inches	0.03937
Millimeters	Meters	0.001
Millimeters	Micrometers	1000
Millimeters	Mils	39.37
Nanometers	Angstrom units	10
Nanometers	Centimeters	$1.0 \times 10^{-7}$
Nanometers	Inches	$3.937 \times 10^{-8}$
Nanometers	Micrometers	0.001
Nanometers	Millimeters	$1.0 \times 10^{-6}$
Yards	Centimeters	91.44
Yards	Meters	0.9144
Mass		
Grains	Grams	0.064799
Grains	Milligrams	64.799
Grains	Pounds (apoth. or troy)	$1.7361 \times 10^{-4}$
Grains	Pounds (avdp.)	$1.4286 \times 10^{-4}$
Grains	Tons (metric)	$6.4799 \times 10^{-8}$
Grams	Dynes	980.67
Grams	Grains	15.432
Grams	Kilograms	0.001
Grams	Micrograms	$1 \times 10^6$
Grams	Pounds (avdp.)	$2.205 \times 10^{-3}$
Grams	Tons. metric (megagrams)	$1 \times 10^{-6}$
Kilograms	Grains	$1.5432 \times 10^4$
Kilograms	Poundals	70.932
Kilograms	Pounds (apoth. or troy)	2.679
Kilograms	Pounds (avdp.)	2.2046
Kilograms	Tons (long)	$9.842 \times 10^{-4}$
Kilograms	Taut (metric)	0.001
Kilograms	Tons (short)	$1.1023 \times 10^{-3}$
Megagrams	Tons (metric)	1.0
Milligrams	Grains	0.01543
Milligrams	Grams	$1.0 \times 10^{-3}$
Milligrams	Ounces (apoth. or troy)	$3.215 \times 10^{-5}$
Milligrams	Ounces (avdp.)	$3.527 \times 10^{-5}$
Milligrams	Pounds (apoth. or troy)	$2.679 \times 10^{-6}$
Milligrams	Pounds (avdp.)	$2.2046 \times 10^{-6}$
Ounces (apoth. or troy)	Grains	480

To Convert From	To	Multiply by
Ounces (apoth. or troy)	Grams	31.103
Ounces (apoth. or troy)	Ounces (avdp.)	1.097
Ounces (avdp.)	Grains	437.5
Ounces (avdp.)	Grams	28.350
Ounces (avdp.)	Ounces (apoth. or troy)	0.9115
Ounces (avdp.)	Pounds (apoth or troy)	0.075955
Ounces (avdp.)	Pounds (avdp.)	0.0625
Pounds (avdp.)	Poundals	32.174
Pounds (avdp.)	Pounds (apoth or troy)	1.2153
Pounds (avdp.)	Tons (long)	$4.4643 \times 10^{-4}$
Pounds (avdp.)	Tons (metric)	$4.5359 \times 10^{-4}$
Pounds (avdp.)	Tons (short)	$5.0 \times 10^{-4}$
Pounds (avdp.)	Grains	7000
Pounds (avdp.)	Grams	453.59
Pounds (avdp.)	Ounces (apoth. or troy)	14.583
Pounds (avdp.)	Ounces (avdp.)	16
Tons (long)	Kilograms	$1.016 \times 10^3$
Tons (long)	Pounds (apoth. or troy)	$2.722 \times 10^3$
Tons (long)	Pounds (avdp.)	$2.240 \times 10^3$
Tons (long)	Tons (metric)	1.016
Tons (long)	Tons (short)	1.12
Tons (metric)	Grams	$1.0 \times 10^6$
Tons (metric)	Megagrams	1.0
Tons (metric)	Pounds (apoth or troy)	$2.6792 \times 10^3$
Tons (metric)	Pounds (avdp.)	$2.2046 \times 10^3$
Tons (metric)	Tons (long)	0.9842
Tons (metric)	Tons (short)	1.1023
Tons (short)	Kilograms	907.18
Tons (short)	Pounds (apoth or troy)	$2.4301 \times 10^3$
Tons (short)	Pounds (avdp.)	2000
Tons (short)	Tons (long)	0.8929
Tons (short)	Tons (metric)	0.9072
Pressure		
Atmospheres	cm of H <sub>2</sub> O (4 °C)	$1.033 \times 10^3$
Atmospheres	Ft of H <sub>2</sub> O (39.2 °F)	33.8995
Atmospheres	In. of Hg (32 °F)	29.9213
Atmospheres	kg/sq cm	1.033
Atmospheres	mm of Hg (0 °C)	760
Atmospheres	Pounds/sq inch	14.696
Inches of (60 °F)	Atmospheres	0.03333
Inches of Hg (6 °F)	Grams/sq cm	34.434
Inches of Hg (6 °F)	mm of Hg (60 °F)	25.4

(Continued)



To Convert From	To	Multiply by
Inches of Hg (6 °F)	Pounds/sq ft	70.527
Inches of H <sub>2</sub> O (4 °C)	Atmospheres	$2.458 \times 10^{-3}$
Inches of H <sub>2</sub> O (4 °C)	In. of Hg (32 °F)	0.07355
Inches of H <sub>2</sub> O (4 °C)	kg/sq meter	25.399
Inches of H <sub>2</sub> O (4 °C)	Pounds/sq ft	5.2022
Inches of H <sub>2</sub> O (4 °C)	Pounds/sq inch	0.036126
Kilograms/sq cm	Atmospheres	0.96784
Kilograms/sq cm	cm of Hg (0 °C)	73.556
Kilograms/sq cm	Ft of H <sub>2</sub> O (39.2 °F)	32.809
Kilograms/sq cm	In. of Hg (32 °F)	28.959
Kilograms/sq cm	Pounds/sq inch	14.223
Millimeters of Hg (0 °C)	Atmospheres	$1.3158 \times 10^{-3}$
Millimeters of Hg (0 °C)	Grams/sq cm	1.3595
Millimeters of Hg (0 °C)	Pounds/sq inch	0.019337
Pounds/sq inch	Atmospheres	0.06805
Pounds/sq inch	cm of Hg (0 °C)	5.1715
Pounds/sq inch	cm of H <sub>2</sub> O (4 °C)	70.309
Pounds/sq inch	In. of Hg (32 °F)	2.036
Pounds/sq inch	In. of H <sub>2</sub> O (39.2 °F)	27.681
Pounds/sq inch	kg/sq cm	0.07031
Pounds/sq inch	mm of Hg (0 °C)	51.715
Velocity		
Centimeters/sec	Feet/min	1.9685
Centimeters/sec	Feet/sec	0.0328
Centimeters/sec	Kilometers/hr	0.036
Centimeters/sec	Meters/min	0.6
Centimeters/sec	Miles/hr	0.02237
Feet/minute	cm/sec	0.508
Feet/minute	Kilometers/hr	0.01829
Feet/minute	Meters/min	0.3048
Feet/minute	Meters/sec	$5.08 \times 10^{-3}$
Feet/minute	Miles/hr	0.01136
Feet/sec	cm/sec	30.48
Feet/sec	Kilometers/hr	1.0973
Feet/sec	Meters/min	18.288
Feet/sec	Miles/hr	0.6818
Kilometers/hr	cm/sec	27.778
Kilometers/hr	Feet/hr	$3.2808 \times 10^3$
Kilometers/hr	Feet/min	54.681
Kilometers/hr	Meters/sec	0.27778
Kilometers/hr	Miles (statute)/hr	0.62137

To Convert From	To	Multiply by
Meters/min	cm/sec	1.6667
Meters/min	Feet/min	3.2808
Meters/min	Feet/sec	0.05468
Meters/min	Kilometers/hr	0.06
Miles/hr	cm/sec	44.704
Miles/hr	Feet/hr	5280
Miles/hr	Feet/min	88
Miles/hr	Feet/sec	1.4667
Miles/hr	Kilometers/hr	1.6093
Miles/hr	Meters/min	26.822
Volume		
Barrels (petroleum, U. S.)	Cu feet	5.6146
Barrels (petroleum, U. S.)	Gallons (U. S.)	42
Barrels (petroleum, U. S.)	Liters	158.98
Barrels (U. S., liq.)	Cu feet	4.2109
Barrels (U. S., liq.)	Cu inches	$7.2765 \times 10^3$
Barrels (U. S., liq.)	Cu meters	0.1192
Barrels (U. S., liq.)	Gallon (U. S., liq.)	31.5
Barrels (U. S., liq.)	Liters	119.24
Cubic centimeters	Cu feet	$3.5315 \times 10^{-5}$
Cubic centimeters	Cu inches	0.06102
Cubic centimeters	Cu meters	$1.0 \times 10^{-6}$
Cubic centimeters	Cu yards	$1.308 \times 10^{-6}$
Cubic centimeters	Gallons (U. S., liq.)	$2.642 \times 10^{-4}$
Cubic centimeters	Quarts (U. S., liq.)	$1.0567 \times 10^{-3}$
Cubic feet	Cubic centimeters	$28317 \times 10^4$
Cubic feet	Cu meter	0.028317
Cubic feet	Gallons (U. S., liq.)	7.4805
Cubic feet	Liters	28.317
Cubic inches	Cu cm	16.387
Cubic inches	Cu feet	$5.787 \times 10^{-4}$
Cubic inches	Cu meter	$1.6387 \times 10^{-5}$
Cubic inches	Cu yards	$2.1433 \times 10^{-5}$
Cubic inches	Gallons (U. S., liq.)	$4.329 \times 10^{-3}$
Cubic inches	Liters	0.01639
Cubic inches	Quarts (U. S., liq.)	0.01732
Cubic meters	Barrels (U. S., liq.)	8.3864
Cubic meters	Cu cm	$1.0 \times 10^6$
Cubic meters	Cu feet	35.315
Cubic meters	Cu inches	$6.1024 \times 10^4$
Cubic meters	Cu yards	1.308

(Continued)

To Convert From	To	Multiply by
Cubic meters	Gallons (U. S., liq.)	264.17
Cubic meters	Liters	1000
Cubic yards	Bushels (Brit.)	21.022
Cubic yards	Bushels (U. S.)	21.696
Cubic yards	Cu cm	$7.6455 \times 10^5$
Cubic yards	Cu feet	27
Cubic yards	Cu inches	$4.6656 \times 10^4$
Cubic yards	Cu meters	0.76455
Cubic yards	Gallons	168.18
Cubic yards	Gallons	173.57
Cubic yards	Gallons	201.97
Cubic yards	Liters	764.55
Cubic yards	Quarts	672.71
Cubic yards	Quarts	694.28
Cubic yards	Quarts	807.90
Gallons (U. S., liq.)	Barrels (U. S., liq.)	0.03175
Gallons (U. S., liq.)	Barrels (petroleum. U. S.)	0.02381
Gallons (U. S., liq.)	Bushels (U. S.)	0.10742
Gallons (U. S., liq.)	Cu centimeters	$3.7854 \times 10^3$
Gallons (U. S., liq.)	Cu feet	0.13368
Gallons (U. S., liq.)	Cu inches	231
Gallons (U. S., liq.)	Cu meters	$3.7854 \times 10^{-3}$
Gallons (U. S., liq.)	Cu yards	$4.951 \times 10^{-3}$

To Convert From	To	Multiply by
Gallons (U. S., liq.)	Gallons (wine)	1.0
Gallons (U. S., liq.)	Liters	3.7854
Gallons (U. S., liq.)	Ounces (U. S., fluid)	128.0
Gallons (U. S., liq.)	Pints (U. S., liq.)	8.0
Gallons (U. S., liq.)	Quarts (U. S., liq.)	4.0
Liters	Cu centimeters	1000
Liters	Cu feet	0.035315
Liters	Cu inches	61.024
Liters	Cu meters	0.001
Liters	Gallons (U. S., liq.)	0.2642
Liters	Ounces (U. S., fluid)	33.814
Volumetric Rate		
Cu ft/min	Cu cm/sec	471.95
Cu ft/min	Cu ft/hr	60.0
Cu ft/min	Gal (U. S.)/min	7.4805
Cu ft/min	Liters/sec	0.47193
Cu meters/min	Gal (U. S.)/min	264.17
Cu meters/min	Liters/min	999.97
Gallons (U. S.)/hr	Cu ft/hr	0.13368
Gallons (U. S.)/hr	Cu meters/min	$6.309 \times 10^{-5}$
Gallons (U. S.)/hr	Cu yd/min	$8.2519 \times 10^{-5}$
Gallons (U. S.)/hr	Liters/hr	3.7854
Liters/min	Cu ft/min	0.0353
Liters/min	Gal (U. S., liq.)/min	0.2642

# Correlation Index

The *correlation index* is based on a plot of the specific gravity ( $d$ ) versus the reciprocal of the boiling point ( $K$ ) in  $^{\circ}\text{K}$  ( $^{\circ}\text{K} = \text{degrees Kelvin} = ^{\circ}\text{C} + 273$ ) for pure hydrocarbons:

$$\text{Correlation Index (CI)} = 473.7d - 456.8 + 48640/K$$

In the case of a petroleum fraction,  $K$  is the average boiling point determined by the standard distillation method.

The line described by the constants of the individual members of the normal paraffin series is given a value of  $\text{CI} = 0$  and a parallel line passing through the point for benzene is given a value of  $\text{CI} = 100$ . Values between 0 and 15 indicate a predominance of paraffinic hydrocarbons in the sample and values from 15 to 20 indicate predominance either of naphthenes or of mixtures of paraffins/naphthenes/aromatics; an index value above 50 indicates a predominance of aromatics in the fraction.



# Corrosion

Corrosion is a process which converts a refined metal to a more stable form, such as its oxide, hydroxide, or sulfide. It is the gradual destruction of materials (usually metals) by chemical and/or electrochemical reaction with the environment but the mechanism of corrosion is not always predictable. The corrosion process degrades the useful properties of materials and structures including strength, appearance and permeability to liquids and gases. Corrosion can be concentrated locally to form a pit or crack, or it can extend across a wide area more or less uniformly corroding the surface.

In the most common use of the word, this means electrochemical oxidation of metal in reaction with an oxidant

such as oxygen or sulfur. Rusting, the formation of iron oxides, is a well-known example of electrochemical corrosion. This type of damage typically produces oxides or salts of the original metal, and may result in a distinctive coloration of the metal surface. Corrosion can also occur in materials other than metals, such as ceramics or polymers, although in this context, the term degradation is more common.

Corrosion is a diffusion-controlled process that occurs on exposed surfaces. As a result, methods to reduce the activity of the exposed surface, such as passivation, can increase a material's corrosion resistance.



## Corrosion – Fuel Ash

Fuel ash corrosion of components in process furnaces, utility boilers, and other equipment where fuels with a high metals content are fired is due to the effects of vanadium and sodium contained in the fuel. Crude oil from Venezuela, the western United States, and Canada have high concentrations of vanadium and other metals. These metals are found in the form of organometallic complexes called porphyrins which are concentrated during the refining cycle in heavy residual fuels. In addition to these organometallic complexes,

sources of additional metallic salts such as spent caustic and entrained salt in the crude are also concentrated in the heavy fuels. These salts act synergistically with the vanadium compounds present and can cause accelerated corrosion of metals and refractories in utility boiler and process furnaces when firing these types of fuels.

Sodium plus vanadium in the fuel in excess of 100 ppm can be expected to form fuel ashes corrosive to metals by fuel oil ashes.





## Corrosion – Naphthenic Acid

Naphthenic acid corrosion occurs primarily in crude and vacuum distillation units, and less frequently in thermal and catalytic cracking operations. It usually occurs in furnace coils, transfer lines, vacuum columns and their overhead condensers, sidestream coolers, and pumps. This corrosion is most pronounced in locations of high velocity, turbulence, and impingement, such as at elbows, weld reinforcements, pump impellers, steam injection nozzles, and locations where freshly condensed fractions drip upon or run down metal surfaces. Metal surfaces corroded by naphthenic acids are characterized by sharp-edged, streamlined grooves or ripples resembling erosion effects, in which all corrosion products have been swept away, leaving very clean, rough surfaces.

Theoretically, corrosion rates from naphthenic acids are proportional to the level of the neutralization number of feedstocks; but investigators have been unable to find a precise correlation between these factors. However, predicting corrosion rates based on the neutralization number remains uncertain but there is a trend toward increasing corrosion with increasing neutralization number. The temperatures required for corrosion by naphthenic acids range from approximately 230 to 400 °C (450 to 750 °F), with maximum rates often occurring between 270 and 280 °C (520 and 535 °F). Whenever rates again show an increase with a rise in temperature above 345 °C (650 °F), the increase is believed to be caused by the influence of sulfur compounds,

which become corrosive to carbon and low alloy steels at that temperature.

Unalloyed mild steel parts have been known to corrode at rates as high as 800 mils per year. The low-chrome steels, through 9-Cr, are sometimes much more resistant than mild steel. The 18-8 Cr-Ni steels, without molybdenum, are often quite resistant under conditions of low velocity although they are sometimes subject to severe pitting. Type 316 (18-8-3 Cr-Ni-Mo) has, by far, the highest resistance to naphthenic acids of any of the 18-8 Cr-Ni alloys and provides adequate protection under most circumstances. It provides excellent protection against both high temperature sulfur corrosion and naphthenic acids, whereas the 18-8 Cr-Ni alloys without molybdenum are not adequate for both. The high-nickel alloys, except those containing copper (such as Monel) are also highly resistant but have little advantage in this respect over Type 316. Copper and all copper alloys, including aluminum-copper alloys such as Duralumin (5-Cu), are unsuitable. Aluminum and aluminum-clad steels are highly resistant to naphthenic acids under most conditions. Aluminum-coated steels give good service until coatings fail at coating imperfections, cracks, welds, or other voids. In general, the use of aluminum and aluminized steels for the control of corrosion by naphthenic acids, as well as by other elevated temperatures corrosion-causing constituents, such as hydrogen sulfide, is somewhat unpredictable and less reliable than Type 316 stainless steel.



# Cricondenbar

The cricondenbar is the maximum pressure at which two phases can exist in equilibrium and is the maximum pressure above which no gas can be formed regardless of temperature. The corresponding temperature is called the cricondenbar temperature. The experimental or the mathematical determinations of these conditions are conveniently expressed in different types of diagrams commonly called *phase diagrams*; one such diagram is called the *pressure-temperature diagram* (Figure). The cricondenbar and especially the cricondenthem are usually of great interest to those involved with measuring, transporting or processing gas. Any time the pressure is below the cricondenbar pressure or the temperature below the cricondenthem, there may be the potential for liquids to present in the gas.

A *phase diagram* (Figure) is a plot of pressure ( $P$  or  $\ln P$ ) versus temperature ( $T$ ). Lines on the diagram represent conditions under which a phase change is at equilibrium. That is, at a point on a line, it is possible for two (or three) phases to coexist at equilibrium. In other regions of the plot, only one phase exists at equilibrium.

At the triple-point temperature, and triple-point pressure, three phases can coexist at equilibrium. At a temperature above the critical temperature and a pressure above the critical pressure it is no longer possible to distinguish between the gas and liquid phases. These multicomponent pressure-temperature diagrams are essentially used to: (1) classify reservoirs, (2) classify the naturally occurring hydrocarbon systems, and (3) describe the phase behavior of the reservoir fluid.

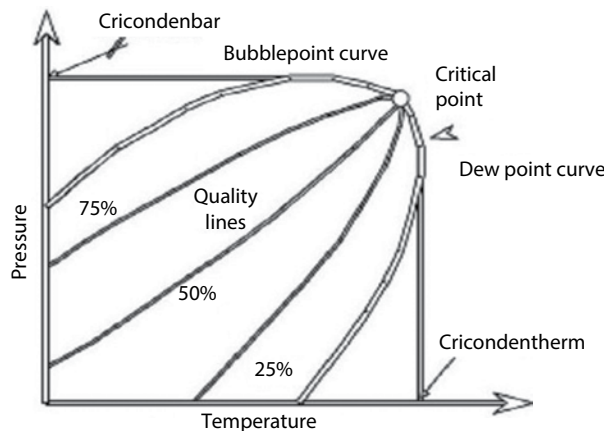

**Figure** Temperature-pressure phase diagram showing the cricondenbar and the cricondenthem.



# Cricondentherm

The cricondentherm temperature is the maximum temperature at which two phases can coexist. A cricondentherm specification at first seems like the best way a pipeline can protect its assets. The transporting pipeline operator knows if it sets a cricondentherm temperature restriction below the lowest temperature seen in its system, it can raise and lower the gas pressure in the pipeline transportation system, and not have to worry about liquid condensation. The cricondentherm temperature is calculated by obtaining an extended gas analysis and then inputting the analysis data into a process simulation software package.

Retrograde condensation occurs in natural gas reservoirs and pipelines when the gas contains hydrocarbons that are liquid at STP. These hydrocarbons are found as single-phase

fluids in deep reservoirs at high pressure and temperature. If the pressure is reduced at constant temperature, it may reach the dew-point curve, which leads to *retrograde condensation*.

Hydrocarbon fluids are in two phases between the bubble point and the dew point curves. The fluid that can enter the two-phase region to the right of the critical point curve are called retrograde condensates. The fluids that are present at temperatures higher than the cricondentherm remain in single-phase at all pressures. If the initial reservoir condition of temperature and pressure is above the phase envelope between critical temperature and cricondentherm, the fluid will go through a dew point and the gas phase is converted to liquid as the pressure in the reservoir decreases.



# Critical Properties

The *critical temperature* of a substance is the temperature at and above which vapor of the substance cannot be liquefied, no matter how much pressure is applied.

The *critical pressure* of a substance is the pressure required to liquefy a gas at its critical temperature.

**Table** Critical properties of selected hydrocarbons and other molecules.

<i>Compound</i>	<i>Formula</i>	<i>Mol. Wt.</i>	<i>Critical T, °F</i>	<i>Critical T, °R</i>	<i>Critical p, psia</i>
Methane	CH <sub>4</sub>	16.04	-116	344	667
Ethane	C <sub>2</sub> H <sub>6</sub>	30.07	90	550	707
Propane	C <sub>3</sub> H <sub>8</sub>	44.09	206	666	616
n-Butane	C <sub>4</sub> H <sub>10</sub>	58.12	306	766	551
i-Butane	C <sub>4</sub> H <sub>10</sub>	58.12	275	735	529
n-Pentane	C <sub>5</sub> H <sub>12</sub>	72.15	386	846	489
i-Pentane	C <sub>5</sub> H <sub>12</sub>	72.15	370	830	490
n-Hexane	C <sub>6</sub> H <sub>14</sub>	86.17	454	914	437
n-Heptane	C <sub>7</sub> H <sub>16</sub>	100.2	512	972	397
n-Octane	C <sub>8</sub> H <sub>18</sub>	114.22	564	1024	362
Hexadecane	C <sub>16</sub> H <sub>34</sub>	226.45	836	1296	202
Eicosane	C <sub>20</sub> H <sub>42</sub>	282.56	926	1386	160
Carbon dioxide	CO <sub>2</sub>	44.01	88	548	1073
Hydrogen Sulfide	H <sub>2</sub> S	34.08	213	673	1306
Nitrogen	N <sub>2</sub>	28.02	-233	673	1306
Water	H <sub>2</sub> O	18.02	705	1165	3206





# Critical Temperatures of Gases

Every gas has a critical temperature above which it cannot be liquefied by the application of pressure alone. The critical pressure is that required to liquefy a gas at its critical temperature (Table). As a consequence, liquefied gases may be stored fully refrigerated, with the liquid at its bubble point at near atmospheric pressure; fully pressurized, i.e., at ambient temperature; or semi-refrigerated with the temperature below ambient but the vapour

pressure above atmospheric pressure. Gases with critical temperatures below ambient must be maintained under refrigeration to keep them in the liquid phase. If the temperature remains constant, the pressure within any cylinder containing liquefied gas will remain constant as gas is drawn off (i.e., more liquid simply evaporates) so the quantity of gas remaining cannot be deduced from the pressure.

**Table** Critical temperature and pressure data for some common gases.

	<i>Critical temperature (°C)</i>	<i>Critical pressure (bar)</i>
Water (steam)	374	–
Sulphur dioxide	157	219
Chlorine	144	78
Ammonia	132	77.7
Nitrous oxide	39	–
Carbon dioxide	31.1	73.1
Oxygen	–119	50
Nitrogen	–147	33.7
Hydrogen	–240	12.9



# Crude Oil – Assay

Analyses that are performed to determine whether each batch of crude oil received at the refinery is suitable for refining purposes are often referred to as the *crude oil assay*. The tests are also applied to determine if there has been any contamination during wellhead recovery, storage, or transportation that may increase the processing difficulty (cost). The information required is generally crude oil dependent or specific to a particular refinery and is also a function of refinery operations and desired product slate. To obtain the necessary information, two different analytical schemes are commonly used: (1) an inspection assay and (2) a comprehensive assay. The crude assay is either a procedure for determining the general distillation characteristics (e.g., distillation profile) and other quality information of crude oil or the results of that procedure (Table).

Inspection assays usually involve determination of several key bulk properties of petroleum (such as API gravity and sulfur content with other options such as pour point and distillation range) as a means of determining if *major* changes in characteristics have occurred since the last comprehensive assay was performed. For example, a more detailed inspection assay might consist of the following tests: API gravity (or density or relative density), sulfur content, pour point, viscosity, salt content, water and sediment content, trace metals (or organic halides). The results from these tests with the archived data from a comprehensive assay provide an estimate of any changes that have occurred in the crude oil that may be critical to refinery operations. Inspection assays are routinely performed on all crude oils received at a refinery.

For assessing the nature of lighter ends of the crude oil, Reid vapor pressure and (RVP) and LPG potential by gas liquid chromatography are carried out. Flow behavior of the crude oil, which is important for its transportation through pipelines, is studied by determining viscosity at different temperatures (dynamic or kinematics at above the pour points and plastic viscosity and yield stress through rotational viscometers below the pour point temperatures).

Rheological behavior of a waxy crude differs significantly from a low wax containing crude. Pour point and wax content (above C<sub>16</sub> paraffins) determinations are also made to highlight the flow behavior of a crude oil.

Characteristics such as asphaltene content, carbon residue and ash content give an idea of the nature of heavy ends

**Table** Tests for a crude oil assay.

Petroleum	Heavy feedstocks*
Density, specific gravity	Density, specific gravity
API gravity	API gravity
Carbon, % w/w	Carbon, % w/w
Hydrogen, % w/w	Hydrogen, % w/w
Nitrogen, % w/w	Nitrogen, % w/w
Sulfur, % w/w	Sulfur, % w/w
	Nickel, ppm
	Vanadium, ppm
	Iron, ppm
Pour point	Pour point
Wax content	
Wax appearance temperature	
Viscosity (various temperatures)	Viscosity (various temperatures)
Carbon residue of residuum	Carbon residue
	Ash, % w/w
Distillation profile:	Fractional composition:
All fractions plus vacuum residue	Asphaltene constituents, % w/w
	Resins, % w/w
	Aromatics, % w/w
	Saturates, % w/w

\*Residua, heavy oil, extra heavy oil, and tar sand bitumen.

of a crude oil. Sulfur, nitrogen, metals and acidity are considered important quality parameters of a crude oil as they deteriorate the quality of products and feedstocks for secondary conversion processes. Cost-intensive processing is required in refineries to treat the distillates to bring down the levels of sulfur, nitrogen and metals. These days, environmental concerns are forcing refiners to produce distillate fuels with ultra-low sulfur content.

Salt content (associated brine), water and sediment are the impurities in a crude oil. Presence of high salt content is the main cause of overhead corrosion in distillation units and deterioration of the bottom product quality as well, as it is responsible for fouling of heat exchangers. Sediment and water occupy precious space in crude oil tanks and increase the sludge as well as cause operational problems.

# Crude Oil – Classification

Conventional crude oil and heavy oil have also been defined very generally in terms of physical properties. For example, heavy oils were considered those petroleum-type materials that had gravity somewhat less than 20° API, with the *heavy oil* falling into the API gravity range 10 to 15° (e.g., Cold Lake crude oil = 12° API) and bitumen falling into the 5 to 10° API range (e.g., Athabasca bitumen = 8 API). Residua vary depending upon the temperature at which distillation is terminated. Atmospheric residua are usually in the 10 to 15° API range, and vacuum residua are in the range 2 to 8° API.

However, the assignment of specific numbers to the classification of petroleum is fraught with difficulty. For example, heavy oil was considered those petroleum-type materials that had gravity somewhat less than 20° API, and generally fell into the API gravity range 10 to 15° with tar sand bitumen falling into the 5 to 10° API range (Speight, 2000). Using such lines of demarcation on an API scale (or on a viscosity scale) does not circumvent the question that must arise when one considers a material having an API gravity equal to 9.9 and one material having an API gravity equal to 10.1. If the line of demarcation on a viscosity scale is 10,000 centipoises, this does not circumvent the question that must arise when one considers a material having a viscosity of 9,950 centipoises and a material having an API gravity equal to 10,050 centipoises. Nor does the line of demarcation make allowance for the limitations of the accuracy of the analytical method. Clearly the use of *one* physical parameter, be it API gravity or any other physical property for that matter, is inadequate to the task of

classifying conventional petroleum, heavy oil, extra heavy oil, and tar sand bitumen.

The general classification of petroleum into conventional petroleum, heavy oil, extra heavy oil, and extra heavy oil involves not only an inspection of several properties but also some acknowledgment of the method of recovery. However, there is a correlation that can be made between various physical properties. Whereas the properties such as viscosity, density, boiling point, and color of petroleum may vary widely, the ultimate or elemental analysis varies, as already noted, over a narrow range for a large number of petroleum samples. Any attempt to classify petroleum, heavy oil, extra heavy oil, and bitumen on the basis of a single property is no longer sufficient to define the nature and properties of these materials, perhaps being an exercise in futility.

Moreover, the United States Congress (US Congress, 1976) has defined tar sands as:

*the several rock types that contain an extremely viscous hydrocarbon which is not recoverable in its natural state by conventional oil well production methods including currently used enhanced recovery techniques.*

By inference, conventional petroleum and heavy oil are recoverable by production methods (i.e., primary and secondary recovery methods) and by currently used enhanced recovery techniques (EOR methods) (Speight 2009). It might also be added that the deposits in which bitumen is found require prior fracturing techniques to overcome the low permeability and allow the passage of fluids.



# Crude Oil – Desalting

The removal of salt from crude oil is recommended for refinery feedstocks if the salt content exceeds 20 PTB (pounds of salt, expressed as equivalent sodium chloride, per thousand barrels of oil). Salt in crude oil, in most cases, is found dissolved in the remnant water (brine) within the oil. It presents serious corrosion and scaling problems and must be removed.

Electrostatic desalting, whether employed for oil field production dehydration and desalting or at oil refineries, is used to facilitate the removal of inorganic chlorides and water-soluble contaminants from crude oil. In refinery applications, the removal of these water-soluble compounds takes place to prevent corrosion damage to downstream distillation processes.

Salt content in crude oil (PTB) is a function of two parameters: (1)  $R$ , which is the amount of water in the crude oil, and (2)  $S$ , which is the salinity of the water. Thus:

$$PTB = f(R, S)$$

In addition, another equation is:

$$PTB = (350 \times sg_{brine})(1000R)/(100-R) \times S/10^6$$

In this equation,  $sg_{brine}$  is the specific gravity of the brine.

The electrostatic desalting process implies two important consecutive actions: (1) wash water injection – water of dilution – to increase the population density of small water droplets suspended in the crude oil, and (2) creating a uniform droplet size distribution by imparting mechanical – typically using an electrostatic coalescer – to assure shearing and dispersion of the dispersed aqueous phase.

In the desalter, the water droplets are so fine in diameter in the range of 1 to 10  $\mu\text{m}$  that they do not settle by gravity. Coalescence produces larger drops that can be settled by gravity. This is accomplished through an electrostatic electric field between two electrodes. The electric field ionizes the water droplets and orients them so that they are attracted to each other. Agitation is also produced and aids in coalescence. The force of attraction between the water droplets is given by:

$$F = KE^2 d^2 \left( \frac{d}{s} \right)^4$$

$E$  is the electric field,  $d$  is the drop diameter and  $s$  is the distance between drops centers and  $K$  is a constant.





# Crude Oil – Distillation

Distillation columns (distillation towers) are made up of several components, each of which is used either to transfer heat energy or enhance material transfer. A typical distillation column consists of several major parts: (1) a vertical shell which houses the column internals and together with the condenser and reboiler constitutes a distillation column (Figure) and where separation of the components is carried out, (2) column internals such as trays, or plates, or packings that are used to enhance component separation, (3) a reboiler to provide the necessary vaporization for the distillation process, (4) a condenser to cool and condense the vapor leaving the top of the column, and (5) a reflux drum to hold the condensed vapor from the top of the column so that liquid (reflux) can be recycled back to the column.

In a petroleum distillation unit, the feedstock liquid mixture is typically introduced near to the mid-point of the column to a tray known as the feed tray. The feed tray divides the column into a top (enriching, rectification) section and a bottom (stripping) section. The feed flows down the column where it is collected at the bottom in the reboiler. Heat is supplied to the reboiler to generate vapor. The source of heat input can be any suitable fluid, although in most chemical plants this is normally steam. In refineries, the heating source may be the output streams of other columns. The vapor raised in the reboiler is reintroduced into the unit at the bottom of the column. The liquid removed from the reboiler is known as the bottoms.

The vapor moves up the column, and as it exits the top of the unit, it is cooled by a condenser. The condensed liquid is stored in a holding vessel known as the reflux drum. Some of this liquid is recycled back to the top of the column, and this is called the reflux. The condensed liquid that is removed from the system is known as the distillate or top product. Thus, there are internal flows of vapor and liquid within

the column as well as external flows of feeds and product streams, into and out of the column.

The column is divided into a number of horizontal sections by metal trays or plates, and each is the equivalent of a still. The more trays, the more redistillation, and hence the better is the fractionation or separation of the mixture fed into the tower. A tower for fractionating crude petroleum may be 13 feet in diameter and 85 feet high according to a general formula:

$$c = 220d^2r$$

where  $c$  is the capacity in bbl/day,  $d$  is the diameter in feet, and  $r$  is the amount of residuum expressed as a fraction of the feedstock.

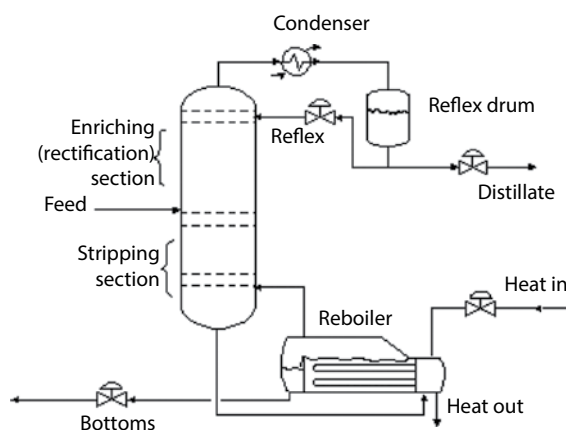

**Figure** Individual parts of an atmospheric distillation column.



# Crude Oil – Fractional Composition

Recognition that refinery behavior is related to the composition of the feedstock has led to a multiplicity of attempts to establish petroleum and its fractions as compositions of matter. As a result, various analytical techniques have been developed for the identification and quantification of *every molecule* in the lower boiling fractions of petroleum. It is now generally recognized that the name *petroleum* does not describe a composition of matter but rather a mixture of various organic compounds that includes a wide range of molecular weights and molecular types that exist in balance with each other. There must also be some questions of the advisability (perhaps *futility* is a better word) of attempting to describe *every molecule* in petroleum. The true focus should be to what ends these molecules can be used.

Thus, investigations of the character of petroleum need to be focused on the influence of its character on refining operations and the nature of the products that will be produced. Furthermore, one means by which the character of petroleum has been studied is through its fractional composition. However, the fractional composition of petroleum varies markedly with the method of isolation or separation, thereby leading to potential complications (especially in the case of the heavier feedstocks) in the choice of suitable processing schemes for these feedstocks. Crude oil can be fractionated into four general fractions: (1) asphaltene fraction, (2) resin fraction, (3) aromatics fraction, and (4) saturates fraction (Figure). Thus, it is possible to compare interlaboratory investigations and thence to apply the concept of predictability to refining sequences and potential products.

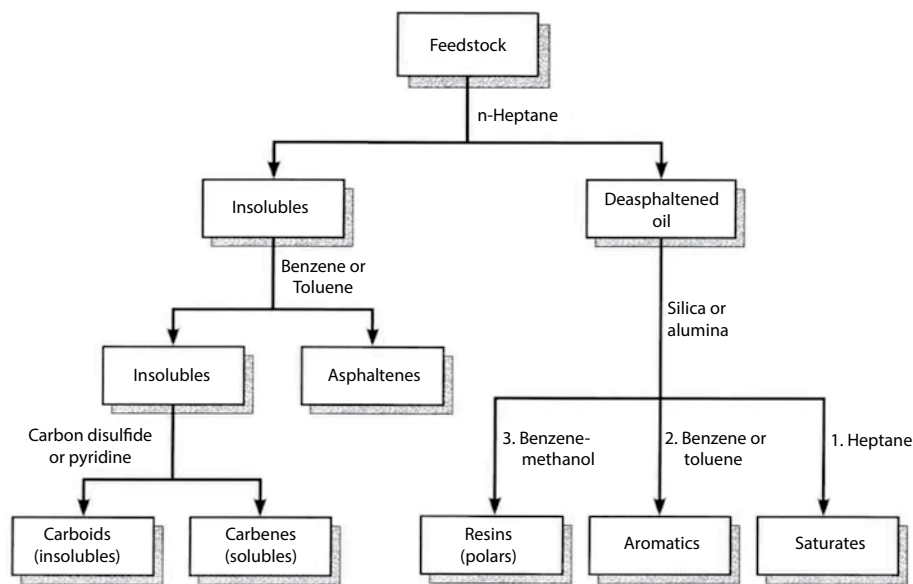

**Figure** A SARA-type analysis (showing two additional fractions – carbenes and carboids that are generally recognized as products of thermal processes as precursors to coke.



# Crude Oil – Hydrotreating

The use of hydrogen in thermal processes is perhaps the single most significant advance in refining technology during the twentieth century. In fact, hydrogenation processes are the principal processes used in the manufacture of naphtha and gasoline (Figure). Indeed, with the influx of heavier feedstocks into refineries, hydroprocessing will assume a greater role in the refinery of the future. The process uses the principle that the presence of hydrogen during a thermal reaction of a petroleum feedstock terminates many of the coke-forming reactions and enhances the yields of the lower boiling components, such as gasoline, kerosene, and jet fuel.

Hydrogenation processes for the conversion of petroleum fractions and petroleum products may be classified as destructive and non-destructive. Destructive hydrogenation (*hydrogenolysis* or *hydrocracking*) is characterized by the cleavage of carbon-carbon linkages accompanied by hydrogen saturation of the fragments to produce lower boiling products. Such treatment requires severe processing

conditions and the use of high hydrogen pressures to minimize polymerization and condensation that lead to coke formation. Many other reactions, such as isomerization, dehydrogenation, and cyclization, occur under the drastic conditions employed.

**Table** Process parameters for hydrodesulfurization.

Parameter	Naphtha	Residuum
Temperature, °C	300–400	340–425
Pressure, atm.	35–70	55–170
LHSV	4.0–10.0	0.2–1.0
H <sub>2</sub> recycle rate, scf/bbl	400–1000	3000–5000
Catalysts life, years	3.0–10.0	0.5–1.0
Sulfur removal, % w/w	99.9	85.0
Nitrogen removal, % w/w	99.5	40.0



# Crude Oil – Molecular Composition

Crude oil contains an extreme range of organic functionality and molecular size. In fact, the variety is so great that it is unlikely that a complete compound-by-compound description for even a single crude oil would be possible. As already noted, the composition of petroleum can vary with the location and age of the field in addition to any variations that occur with the depth of the individual well. Two adjacent wells are more than likely to produce petroleum with very different characteristics.

In very general terms (and as observed from elemental analyses), petroleum, heavy oil, bitumen, and residua are a complex composition of: (a) hydrocarbon derivatives; (b) nitrogen derivatives; (c) oxygen derivatives; (d) sulfur derivatives; and (e) metallic constituents. However, this general definition is not adequate to describe the composition of petroleum as it relates to the behavior. Indeed, the consideration of hydrogen-to-carbon atomic ratio, sulfur content, and API gravity are no longer adequate to the task of determining refining behavior.

Furthermore, the molecular composition of petroleum can be described in terms of three classes of compounds: saturates, aromatics, and compounds bearing heteroatoms (sulfur, oxygen, or nitrogen). Within each class, there are several families of related compounds: (1) saturated constituents include normal alkane derivatives, branched alkane derivatives and cycloalkane derivatives (paraffins, iso-paraffins, and naphthenes, respectively, in petroleum terms), (2) alkene constituents (olefins) are rare to the extent of being considered an oddity, (3) monoaromatic constituents range from benzene to multiple fused ring analogs (naphthalene, phenanthrene, etc.), (4) thiol (mercaptan) constituents contain sulfur as do thioether derivatives and thiophene derivatives, (5) nitrogen-containing and oxygen-containing

constituents are more likely to be found in polar forms (such as pyridine derivatives, pyrrole derivatives, phenol derivatives, carboxylic acid derivatives, amide derivatives) than in non-polar forms (such as ethers). The distribution and characteristics of these molecular species account for the wide variation of the behavior of crude oils.

An understanding of the chemical types (or composition) of any feedstock can lead to an understanding of the chemical aspects of processing the feedstock. Processability is not only a matter of knowing the elemental composition of a feedstock; it is also a matter of understanding the bulk properties as they relate to the chemical or physical composition of the material. For example, it is difficult to understand, *a priori*, the process chemistry of various feedstocks from the elemental composition alone. From such data, it might be surmised that the major difference between a heavy crude oil and a more conventional material is the H/C atomic ratio alone. This property indicates that a heavy crude oil (having a lower H/C atomic ratio and being more aromatic in character) would require more hydrogen for upgrading to liquid fuels. This is, indeed, true but much more information is necessary to understand the *processability* of the feedstock.

The presence of traces of non-hydrocarbon compounds can impart objectionable characteristics to finished products, leading to discoloration and/or lack of stability during storage. On the other hand, catalyst poisoning and corrosion are the most noticeable effects during refining sequences when these compounds are present. It is therefore not surprising that considerable attention must be given to the non-hydrocarbon constituents of petroleum as the trend in the refining industry, of late, has been to process more heavy crude oil as well as residua that contain substantial proportions of these non-hydrocarbon materials.

**Table** Compound types in petroleum and petroleum fractions.

<b>Class</b>	<b>Compound types</b>
Saturated hydrocarbons	n-Paraffin derivatives
	iso-Paraffin derivatives and other branched paraffin derivatives
	Cycloparaffin derivatives (naphthenes)
	Condensed cycloparaffin derivatives (including steranes, hopanes)
	Alkyl side chains on ring systems
Unsaturated hydrocarbons	Olefin derivatives not indigenous to petroleum; present in products of thermal reactions
Aromatic hydrocarbons	Benzene systems
	Condensed aromatic systems
	Condensed aromatic-cycloalkyl systems
	Alkyl side chains on ring systems
Saturated heteroatomic systems	Alkyl sulfide derivatives
	Cycloalkyl sulfide derivatives
	Alkyl side chains on ring systems
Aromatic heteroatomic systems	Furan derivatives (single-ring and multi-ring systems)
	Thiophene derivatives (single-ring and multi-ring systems)
	Pyrrole derivatives (single-ring and multi-ring systems)
	Pyridine derivatives (single-ring and multi-ring systems)
	Mixed heteroatomic systems
	Amphoteric (acid-base) systems
	Alkyl side chains on ring systems



# Crude Oil – Primary Recovery

Primary recovery (primary production) is the first stage of crude oil production, in which natural reservoir energy, such as gas drive, water drive or gravity drainage, displaces the crude oil from the reservoir, into the wellbore and up to surface. Initially, the reservoir pressure is considerably higher than the bottomhole pressure inside the wellbore and the high natural differential pressure drives hydrocarbons toward the well and up to surface.

As the reservoir pressure declines because of production, so does the differential pressure, and to reduce the

bottomhole pressure or increase the differential pressure to increase hydrocarbon production, it is necessary to implement an artificial lift system, such as rod pump, an electrical submersible pump or a gas-lift installation.

The primary recovery stage reaches its limit either when the reservoir pressure is so low that the production rates are not economical, or when the proportions of gas or water in the production stream are too high. During primary recovery, only a small percentage of the initial hydrocarbons in place are produced, typically approximately 10% v/v for crude oil reservoirs.



# Crude Oil – Recovery

Recovery, as applied in the petroleum industry, is the production of oil from a reservoir. There are several methods by which this can be achieved that range from recovery due to reservoir energy (i.e., the oil flows from the well without assistance) to enhanced recovery methods in which considerable energy must be added to the reservoir to produce the oil. However, the effect of the method on the oil and on the reservoir (Table) must be considered before application of any recovery process.

The oil in the reservoir is usually under such great pressure that it flows naturally, and sometimes with great force, from the well. However, in some cases this pressure later diminishes so that the oil must be pumped from the well. Natural gas or water is sometimes pumped into the well to replace the oil that is withdrawn. This is called repressurizing the oil well. Thus the anatomy of a reservoir is complex

and is site- specific, microscopically and macroscopically. Because of the various types of accumulations and the existence of wide ranges of both rock and fluid properties, reservoirs respond differently and must be treated individually.

For a newly opened formation and under ideal conditions the proportions of gas may be so high that the oil is, in fact, a solution of liquid in gas that leaves the reservoir rock so efficiently that a core sample will not show any obvious oil content. A general rough indication of this situation is a high ratio of gas to oil produced. This ratio may be zero for fields in which the rock pressure has been dissipated. The oil must be pumped out to as much as 50,000 ft<sup>3</sup> or more of gas per barrel of oil in the so-called condensate reservoirs, in which a very light crude oil (0.80 specific gravity or lighter) exists as vapor at high pressure and elevated temperature.

**Table** Recovery process parameters and their potential adverse effects leading to sludge and sediment formation.

Property	Comments
Carbon dioxide injection	Lowers pH; can change oil composition leading to phase separation of sludge or sediment and blocking of channels.
Miscible flooding	Hydrocarbon-rich gases lower the solubility parameter and solvent power of the oil and cause separation of asphaltene material.
Organic chemicals	Can lower the solubility parameter and solvent power of the oil and cause separation of asphaltene material; blocking of channels.
Acidizing	Interaction of crude oil constituents upsetting molecular balance and deposition of sludge or sediment; blocking of channels.
Pressure decrease	Can change composition of oil medium leading to phase separation of asphaltene material as sludge or sediment; blocking of channels.
Temperature decrease	Can change composition of oil medium leading to phase separation of asphaltene material as sludge or sediment; blocking of channels.



# Crude Oil – Refining

Crude oil refining is the separation of petroleum into fractions and the subsequent treating of these fractions to yield marketable. A refinery is essentially a group of manufacturing plants which vary in number with the variety of products produced using a variety of processes and process parameters (Tables 1–6, Figures 1–2). Refinery processes must be selected and products manufactured to give a balanced operation in which petroleum is converted into a variety of products that are in accord with the demand for each. To prevent the occurrence of oversupply or underdemand, the refinery must be flexible and be able to change operations

as needed. This usually means more processes: thermal processes to change an excess of heavy fuel oil into more gasoline with coke as the residual product, or a vacuum distillation process to separate the heavy oil into lubricating oil stocks and asphalt.

Refinery processes for crude oil are generally divided into three categories: (1) separation processes, of which distillation is the prime example, (2) conversion processes, of which coking and catalytic cracking are prime examples, and (3) finishing processes, of which hydrotreating to remove sulfur is a prime example.

**Table 1** Examples of the types of reactors used in a refinery, including a gas processing plant.

<i>Process</i>	<i>Examples</i>	<i>Reactor-types</i>
Refinery processes	Reactive distillation	Bubble column
	Visbreaking and coking	Batch, semi-batch, fluidized-bed
	Catalytic cracking, product improvement	Catalytic two- and three-phase processes packed and fluidized beds, trickle beds, bubble columns
Petrochemical processes	Fine chemicals	Packed and fluidized beds batch, tank, and tube reactors three-phase reactors, bubble columns
	Polymer manufacture	Packed beds, tube reactors, tank reactors
Gas processing	Removal of hydrogen sulfide and carbon dioxide	Absorption columns
		Fixed-beds
Combustion	Combustion of resids	Packed and fluidized beds
Gasification	Gasification of resids	Fluidized beds
Manufacture of synthetic fuels	Fischer-Tropsch	Packed and fluidized beds

**Table 2** Separation processes and conversion processes.

<b>(i) Separation Processes:</b>					
<b>Process Name</b>	<b>Action</b>	<b>Method</b>	<b>Purpose</b>	<b>Feedstock(s)</b>	<b>Product(s)</b>
Atmospheric distillation	Separation	Thermal	Separate fractions without cracking	Desalted crude oil	Gas, gas oil, distillate, residual
Vacuum distillation	Separation	Thermal	Separate fraction without cracking	Atmospheric tower residua	Gas oil, lube stock, residual
<b>(ii) Conversion Processes:</b>					
<b>Process Name</b>	<b>Action</b>	<b>Method</b>	<b>Purpose</b>	<b>Feedstock(s)</b>	<b>Product(s)</b>
Catalytic cracking	Alteration	Catalytic	Upgrade gasoline	Gas oil, coke, distillate	Gasoline, petrochemical feedstock
Coking	Polymerize	Thermal	Convert vacuum residuals	Gas oil, coke distillate	Gasoline, petrochemical feedstock
Hydrocracking	Hydrogenate	Catalytic	Convert to lighter hydrocarbons	Gas oil, cracked oil, residual	Lighter, higher-quality products
Visbreaking	Decompose	Thermal	Reduce viscosity	Atmospheric tower resid	Distillate, tar

**Table 3** Comparison of visbreaking with delayed coking and fluid coking.

<p><b>Visbreaking</b></p> <p>Purpose: to reduce viscosity of fuel oil to acceptable levels</p> <p>Conversion is not a prime purpose</p> <p>Mild (470 to 495 °C; 880 to 920 °F) heating at pressures of 50 to 200 psi</p> <ul style="list-style-type: none"> <li>Reactions quenched before going to completion</li> <li>Low conversion (10%) to products boiling less than 220 °C (430 °F)</li> </ul> <p>Heated coil or drum (soaker)</p>
<p><b>Delayed Coking</b></p> <p>Purpose: to produce maximum yields of distillate products</p> <p>Moderate (480 to 515 °C; 900 to 960 °F) heating at pressures of 90 psi</p> <ul style="list-style-type: none"> <li>Reactions allowed to proceed to completion</li> <li>Complete conversion of the feedstock</li> </ul> <p>Soak drums (845 to 900 °F) used in pairs (one on stream and one off stream being de-coked)</p> <p>Coked until drum solid</p> <p>Coke removed hydraulically from off-stream drum</p> <p>Coke yield: 20–40% by weight (dependent upon feedstock)</p> <p>Yield of distillate boiling below 220 °C (430 °F): ca. 30% (but feedstock dependent)</p>
<p><b>Fluid Coking</b></p> <p>Purpose: to produce maximum yields of distillate products</p> <p>Severe (480 to 565 °C; 900 to 1050 °F) heating at pressures of 10 psi</p> <ul style="list-style-type: none"> <li>Reactions allowed to proceed to completion</li> <li>Complete conversion of the feedstock</li> </ul> <p>Oil contacts refractory coke</p> <p>Bed fluidized with steam; heat dissipated throughout the fluid bed</p> <p>Higher yields of light ends (&lt;C<sub>5</sub>) than delayed coking</p> <p>Less coke yield than delayed coking (for one particular feedstock)</p>

**Table 4** Summary of catalytic cracking processes.

<b>Conditions</b>
Solid acidic catalyst (silica-alumina, zeolite, etc.) Temperature: 480 to 540 °C (900 to 1000 °F (solid/vapor contact)) Pressure: 10 to 20 psi Provisions needed for continuous catalyst replacement with heavier feedstocks (residua) Catalyst may be regenerated or replaced
<b>Feedstocks</b>
Gas oils and residua Residua pretreated to remove salts (metals) Residua pretreated to remove high molecular weight (asphaltic constituents)
<b>Products</b>
Lower molecular weight than feedstock Some gases (feedstock and process parameters dependent) Iso-paraffins in product Coke deposited on catalyst
<b>Variations</b>
Fixed bed Moving bed Fluidized bed

**Table 5** Summary of hydrocracking processes.

<b>Conditions</b>
Solid Acid Catalyst (silica-alumina with rare earth metals, various other options) Temperature: 260 to 450 °C (500 to 845 °F (solid/liquid contact)) Pressure: 1,000 to 6,000 psi hydrogen Frequent catalysts renewal for heavier feedstocks Gas oil: catalyst life up to three years Heavy oil/tar sand bitumen: catalyst life less than one year
<b>Feedstocks</b>
Refractory (aromatic) streams Coker oils, Cycle Oils Gas oils Residua (as a full hydrocracking or hydrotreating option) In some cases, asphaltic constituents (S, N, and metals) removed by deasphalting
<b>Products</b>
Lower molecular weight paraffins Some methane, ethane, propane, and butane Hydrocarbon distillates (full range depending on the feedstock) Residual tar (recycle) Contaminants (asphaltic constituents) deposited on the catalyst as coke or metals
<b>Variations</b>
Fixed bed (suitable for liquid feedstocks) Ebullating bed (suitable for heavy feedstocks)

**Table 6** Comparison of various refinery types.

Refinery type	Processes	Alternate type name	Complexity	Comparative range*
Topping	Distillation	Skimming	Low	1
Hydroskimming	Distillation Reforming Hydrotreating	Hydroskimming	Moderate	3
Conversion	Distillation Fluid catalytic cracking Hydrocracking Reforming Alkylation (etc.) Hydrotreating	Cracking	High	6
Deep conversion	Distillation Coking Fluid catalytic cracking Hydrocracking Reforming Alkylation (etc.) Hydrotreating	Coking	Very high	10

\*Indicates complexity on an arbitrary numerical scale of 1–10

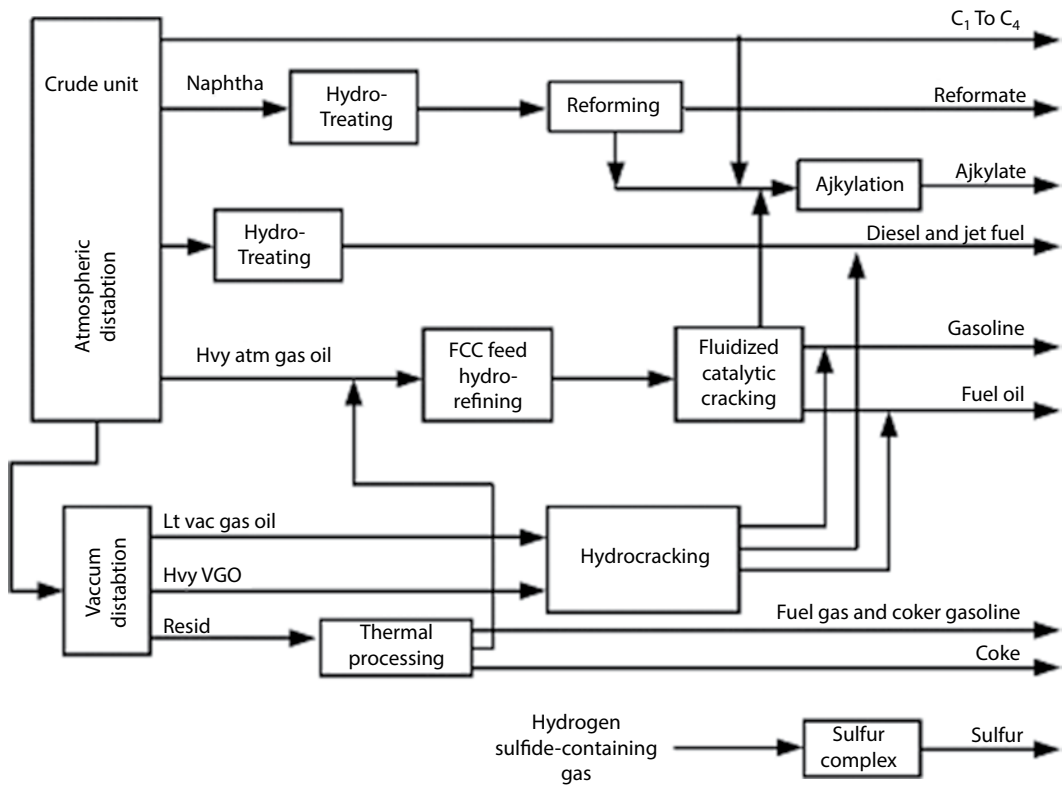

Figure 1 Schematic overview of a refinery.

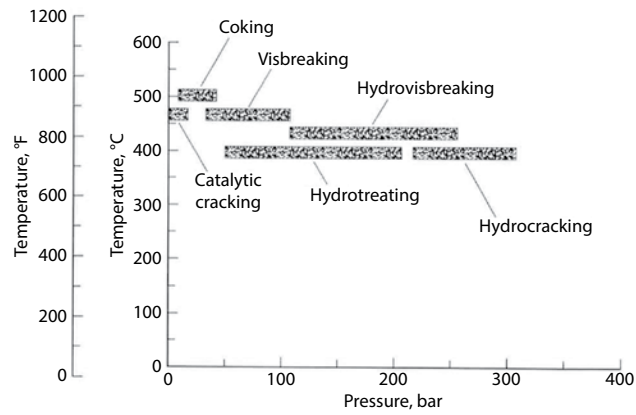

Figure 2 Temperature and pressure ranges for various processes.



# Crude Oil – Residua

A *resid* (*residuum*, *pl. residua*) is the residue obtained from petroleum after non-destructive distillation has removed all the volatile materials (Figure 1). The temperature of the distillation is usually maintained below 350 °C (660 °F) since the rate of thermal decomposition of petroleum constituents is minimal below this temperature but the rate of thermal decomposition of petroleum constituents is substantial above 350 °C (660 °F). *Resids* are black, viscous materials and are obtained by distillation of a crude oil under atmospheric pressure (atmospheric residuum) or under reduced pressure (vacuum residuum). They may be liquid at room temperature (generally atmospheric residua) or almost solid (generally vacuum residua) depending upon the nature of the crude oil from which they are produced and the cut point of the resid (Table, Figure 2).

When a residuum is obtained from a crude oil and thermal decomposition has commenced, it is more usual to refer to this product as *pitch*. The differences between a parent petroleum and the residua are due to the relative amounts of various constituents that are present, which are removed or remain by virtue of their relative volatility. The chemical composition of a residuum from an asphaltic crude oil is complex. Physical methods of fractionation usually indicate high proportions of asphaltenes and resins, even in amounts up to 50% (or higher) of the residuum. In addition, the presence of ash-forming metallic constituents, including such organometallic compounds as those of vanadium and nickel, is also a distinguishing feature of residua and the heavier oils. Furthermore, the deeper the *cut* into the crude oil, the greater is the concentration of sulfur and metals in the residuum and the greater the deterioration in physical properties.

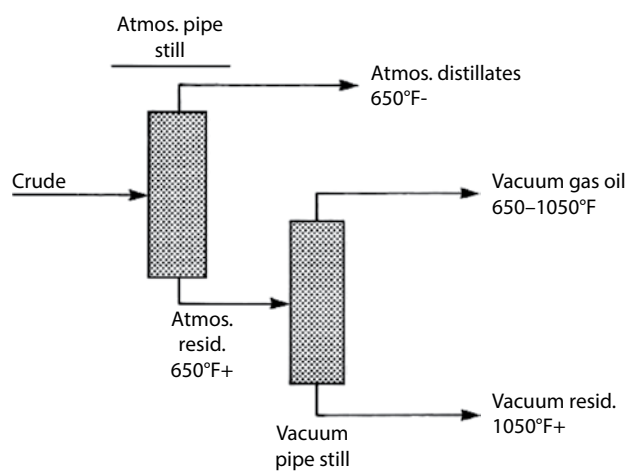

**Figure 1** The production of residua in a refinery.

Table Properties of atmospheric and vacuum residua.

Feedstock	Gravity API	Sulfur % w/w	Nitrogen % w/w	Nickel ppm w/w	Vanadium ppm w/w	Asphaltenes (heptane) wt. %	Carbon residue (Conradson) % w/w
Arabian Light, >650 °F	17.7	3.0	0.2	10.0	26.0	1.8	7.5
Arabian Light, >1050 °F	8.5	4.4	0.5	24.0	66.0	4.3	14.2
Arabian Heavy, > 650 °F	11.9	4.4	0.3	27.0	103.0	8.0	14.0
Arabian Heavy, >1050 °F	7.3	5.1	0.3	40.0	174.0	10.0	19.0
Alaska, North Slope, >650 °F	15.2	1.6	0.4	18.0	30.0	2.0	8.5
Alaska, North Slope, >1050 °F	8.2	2.2	0.6	47.0	82.0	4.0	18.0
Lloydminster, >650 °F	10.3	4.1	0.3	65.0	141.0	14.0	12.1
Lloydminster, >1050 °F	8.5	4.4	0.6	115.0	252.0	18.0	21.4
Kuwait, >650 °F	13.9	4.4	0.3	14.0	50.0	2.4	12.2
Kuwait, >1050 °F	5.5	5.5	0.4	32.0	102.0	7.1	23.1
Tia Juana, >650 °F	17.3	1.8	0.3	25.0	185.0		9.3
Tia Juana, >1050 °F	7.1	2.6	0.6	64.0	450.0		21.6
Taching, >650 °F	27.3	0.2	0.2	5.0	1.0	4.4	3.8
Taching, >1050 °F	21.5	0.3	0.4	9.0	2.0	7.6	7.9

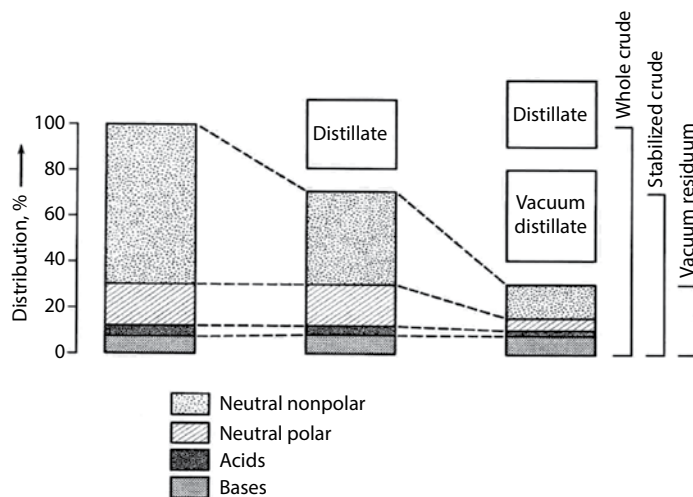

Figure 2 Accumulation of polar functions in residua during distillation.

# Crude Oil – Sampling and Analysis

Analytical data are derived from a series of tests that give an accurate description of petroleum quality and allow an indication of its behavior during refining. The first step is, of course, to assure adequate (correct) sampling by use of the prescribed protocols and by recording the storage and handling of the crude oil by use of a sampling log (Table) (ASTM D4057).

Thus, analyses are performed to determine whether each batch of crude oil received at the refinery is suitable for refining purposes. The tests are also applied to determine if there has been any contamination during wellhead recovery, storage, or transportation that may increase the processing difficulty (cost). The information required is generally crude oil dependent or specific to a particular refinery and is also a function of refinery operations and desired product slate. To obtain the necessary information, two different analytical schemes are commonly used: (1) an inspection assay and (2) a comprehensive assay. Inspection assays usually involve determination of several key bulk properties of petroleum (e.g., API gravity, sulfur content, pour point, and distillation range) as a means of determining if *major* changes in characteristics have occurred since the last comprehensive assay was performed.

For example, a more detailed inspection assay might consist of the following tests: API gravity (or density or relative density), sulfur content, pour point, viscosity, salt content, water and sediment content, trace metals (or organic halides). The results from these tests with the archived data from a comprehensive assay provide an estimate of any changes that have occurred in the crude oil that may be critical to refinery operations. Inspection assays are routinely performed on all crude oils received at a refinery.

On the other hand, the comprehensive (or full) assay is more complex (as well as time-consuming and costly) and is usually performed only when a new field comes on

**Table** Suggested items to be included in a sampling log.

The precise (geographic or other) location (or site or refinery or process) from which the sample was obtained.
The identification of the location (or site or refinery or process) by name.
The character of the bulk material (solid, liquid, or gas) at the time of sampling.
The means by which the sample was obtained.
The means and protocols that were used to obtain the sample.
The date and the amount of sample that was originally placed into storage.
Any chemical analyses (elemental analyses, fractionation by adsorbents or by liquids, functional type analyses) that have been determined to date.
Any physical analyses (API gravity, viscosity, distillation profile) that have been determined to date.
The date of any such analyses included in items 7 and 8.
The methods used for analyses that were employed in items 7 and 8.
The analysts who carried out the work in items 7 and 8.
A log sheet showing the names of the persons (with the date and the reason for the removal of an aliquot) who removed the samples from storage and the amount of each sample (aliquot) that was removed for testing.

stream, or when the inspection assay indicates that significant changes in the composition of the crude oil have occurred. Except for these circumstances, a comprehensive assay of a particular crude oil stream may not (unfortunately) be updated for several years. A full petroleum assay may involve at least determinations of (1) carbon residue yield, (2) density (specific gravity), (3) sulfur content, (4) distillation profile (volatility), (5) metallic constituents, (6)

viscosity, and (7) pour point as well as any tests designated necessary to understand properties and behavior of the crude oil under examination.

Using the data derived from the test assay, it is possible to assess petroleum quality with a degree of predictability

of performance during refining. However, even knowledge of the basic concepts of refining will help the analyst understand the production and, to a large extent, the anticipated properties of the product, which in turn is related to storage, sampling, and handling the products.

# Crude Oil – Secondary Recovery

Secondary recovery operations occur after the primary recovery phase. Many, but not all, oil fields respond positively to secondary recovery techniques in which external fluids are injected into a reservoir to increase reservoir pressure and to displace oil towards the wellbore. Secondary recovery techniques often result in increases in production and reserves above primary recovery.

Waterflooding, a form of secondary recovery, works by repressuring a reservoir through water injection and sweeping or pushing oil to producing wellbores. The water used for injection is brackish, non-potable water that is co-produced with the oil or obtained by drilling a well into a water bearing formation. Through waterflooding, water injection replaces the loss of reservoir pressure caused by the primary production of oil and gas, which is often referred to as pressure depletion or reservoir voidage. The degree to which

reservoir voidage has been replaced through water injection is known as “reservoir fill up” or simply as fill up. A reservoir which has had all of the produced fluids replaced by injection is at 100% fill up. In general, peak oil production from a waterflood typically occurs at 100% fill up.

Estimating the percentage of fill up which has occurred, or when a reservoir is 100% filled up, is subject to a wide variety of engineering and geologic uncertainties. As a result of the water used in a waterflood, produced fluids contain both water and oil, with the relative amount of water increasing over time. Surface equipment is used to separate the oil from the water, with the oil going to pipelines or holding tanks for sale and the water being recycled to the injection facilities. In general, a secondary recovery project may produce an additional 10% to 20% v/v of the oil originally in place in a reservoir.



# Crude Oil – Tertiary Recovery

Tertiary recovery methods (often referred to as enhanced oil recovery (EOR), involves use of a variety of techniques that change the properties of the crude oil to make it more conducive to extraction. There are three main types of enhanced oil recovery:

- *Thermal Recovery*: is the most prevalent type of enhanced oil recovery and involves heating the oil to reduce its viscosity and allowing easier flow to the surface. This is most commonly achieved by introducing steam into the reservoir, which will work to heat the oil. Less commonplace is the practice of burning part of the oil in order to heat the rest (fire flooding, *in situ* combustion).
- *Gas Injection*: in this method, either natural gas, nitrogen or carbon dioxide (increasingly the most popular option) are injected into the reservoir to mix with the oil, making it more viscous, whilst simultaneously pushing the oil to the surface (similar to secondary oil recovery).
- *Chemical Injection*: involves freeing trapped oil in the well. This is done by lowering surface tension and increasing the efficiency of waterflooding. The method can make use of detergent-like surfactants to help lower the surface tension that often prevents crude oil droplets from moving through the reservoir.





# Crude Oil from Tight Formations

Generally, unconventional tight oil resources are found at considerable depths in sedimentary rock formations that are characterized by very low permeability. While some of the tight oil plays produce oil directly from shales, tight oil resources are also produced from low-permeability siltstone formations, sandstone formations, and carbonate formations that occur in close association with a shale source rock. Tight formations scattered throughout North America have the potential to produce crude oil (*tight oil*). Such formations might be composed of shale sediments or sandstone sediments. In a conventional sandstone reservoir, the pores are interconnected so gas and oil can flow easily from the rock to a wellbore. In tight sandstones, the pores are smaller and are poorly connected by very narrow capillaries, which results in low permeability. Tight oil occurs in sandstone sediments that have an effective permeability of less than 1 milliDarcy (<1 mD). A shale play is a defined geographic area containing an organic-rich fine-grained sedimentary rock that underwent physical and chemical compaction during diagenesis to produce the following characteristics: (1) clay to silt sized particles, (2) high % of silica, and sometimes carbonate minerals, (3) thermally mature, (4) hydrocarbon-filled porosity – on the order of 6 to 14%, (5) low permeability – on the order of <0.1 mD,, (6) large areal distribution, and (7) fracture stimulation required for economic production.

The most notable tight oil plays in North America include the Bakken shale, the Niobrara formation, the Barnett shale, the Eagle Ford shale, and the Miocene Monterey play of California's San Joaquin Basin and the Cardium play (Alberta, Canada). In many of these tight formations, the existence of large quantities of crude oil has been known for decades and efforts to commercially produce those resources have occurred sporadically with typically disappointing results. However, starting in the mid-2000s, advancements in drilling wells and stimulation technologies combined with high

oil prices have turned tight oil resources into one of the most actively explored and produced targets in North America.

Other known tight formations (on a worldwide basis) include the R'Mah Formation (Syria), the Sargelu Formation (northern Persian Gulf region), the Athel Formation (Oman), the Bazhenov formation and Achimov Formation (West

**Table 1** Comparison of API gravity and sulfur content of selected crude oils including crude oil from the Bakken and Eagle Ford formations.

Crude oil	API gravity	Sulfur, % w/w	Light ends % v/v
Bakken	40–43	0.1	7.2
Eagle Ford	47.7	0.1	8.3
West Texas Intermediate	37–42	0.42	6.1
Louisiana Light Sweet	36–40	0.39	3.0
Brent	37–39	0.4	5.3
Arabian Light	33	1.98	
Arabian Heavy	27.7	2.99	

**Table 2** Distillation yields from eagle ford crude oil.

Fraction	Boiling range		Yield % v/v
	IBP	FBP	
C1-C4	<85	<85	1
Light naphtha	85	200	14
Heavy Naphtha	200	350	23
Kerosene	350	450	12
Light gas oil	450	650	21
Vacuum gas oil	650	1050	24
Residuum	1050+		5

Siberia, Russia), the Coober Pedy formation (Australia), the Chicontepex formation (Mexico), and the Vaca Muerta field (Argentina). However, tight oil formations are heterogeneous and vary widely over relatively short distances. Thus, even in a single horizontal production well, the amount of oil recovered may vary as may recovery within a field or even between adjacent wells. This makes evaluation of *shale plays* and decisions regarding the profitability of wells on a particular lease difficult. In addition, a tight reservoir which

contains only crude oil (without natural gas as the pressurizing agent), cannot be economically produced.

The properties of crude oils from tight formations are highly variable. Density and other properties can show wide variation, even within the same field. The Bakken crude is light and sweet with an API of 42° and a sulfur content of 0.19% w/w. Similarly, Eagle Ford is a light sweet feed, with a sulfur content of approximately 0.1% w/w and with published API gravity between 40° API and 62° API.

# Darcy and Non-Darcy Flow in Porous Media

To perform natural gas deliverability calculations, it is essential to understand the fundamentals of gas flow in porous media. Fluid flow is affected by the competing inertial and viscous effects, combined by the well-known Reynolds number, whose value delineates laminar from turbulent flow. In porous media, the limiting Reynolds number is equal to 1 based on the average grain diameter.

Because permeability and grain diameter are well connected, for small permeability values (e.g., less than 0.1 md) the production rate is generally small; flow is laminar near

the crucial sand face and it is controlled by Darcy's law. An amount of connate water is always present with the gas. Such water saturation is immobile and, therefore,  $k_g$  equals the effective permeability to gas and can be treated as the single-phase permeability.

Non-Darcy flow occurs in the near-wellbore region of high capacity gas and condensate reservoirs: As the flow area is reduced substantially, the velocity increases, inertial effects become important, and the gas flow becomes non-Darcy.



# Darcy's Law

For laminar single fluid flows in straight ducts, the flow resistance or pressure drop is proportional to the flow rate. The same relationship holds for flow in curved ducts when the flow velocity is very small. This unique relationship between the flow velocity and the pressure drop can be generalized to flow through porous media as well,

$$\frac{dp}{dx} - \rho g_x \propto -u$$

In this equation,  $u$  is the superficial fluid flow velocity (or discharge rate per unit cross-sectional area),  $p$  is the fluid pressure,  $x$  is the linear coordinate in the flow direction,  $\rho$  is the fluid density and  $g_x$  is the gravity in the direction of flow. This limiting flow behavior has received great attention for centuries. It has been the basis for macroscopic modeling flow through packed beds; the proportionality constant can be determined if a flow geometry is defined.

A one-dimensional empirical model continuum, for saturated single fluid flow in porous media was based on the proportionality and Darcy's law can also be expressed as:

$$u = -\frac{k}{\mu} \left( \frac{\partial p}{\partial x} - \rho g_x \right)$$

where  $k$  is the permeability of the porous medium which is assumed to be constant in applications and  $\mu$  is the dynamic viscosity of the fluid. Darcy's law has been generalized to be used for multidimensional single-phase and multiphase flows. Here, multiphase flows specifically mean immiscible multiphase flows. For miscible systems, one can effectively treat them as single-phase flows.

For single-phase flows, Darcy's law lacks both the flow diffusion effects and the inertial effects. Therefore, the utility of Darcy's law is restrictive and validation of the modeling results is often necessary. Remedies of these defects have been adjusted by addition of a diffusion term to Darcy's law:

$$\nabla p - \rho \mathbf{g} = -\frac{\mu}{k} \mathbf{v} + \tilde{\mu} \nabla^2 \mathbf{v}$$

$\tilde{\mu}$  is an effective viscosity and  $\mathbf{v}$  is the superficial fluid flow velocity field. In general, the effective viscosity  $\tilde{\mu}$  is proportional to the fluid viscosity  $\mu$  and is affected by the type of porous media. For simplicity and convenience, the effective viscosity is usually taken to be identical to the fluid viscosity.



## Decimal Multipliers for SI Prefixes

Prefix	Origin	Symbol	Multiplying Factor
yotta	Greek or Latin <i>octo</i> , “eight”	Y	$10^{24}$
zetta	Latin <i>septem</i> , “seven”	Z	$10^{21}$
exa	Greek <i>hex</i> , “six”	E	$10^{18}$
peta	Greek <i>pente</i> , “five”	P	$10^{15}$
tera	Greek <i>teras</i> , “monster”	T	$10^{12}$
giga	Greek <i>gigas</i> , “giant”	G	$10^9$
mega	Greek <i>megas</i> , “large”	M	$10^6$
kilo	Greek <i>chilioi</i> , “thousand”	k	$10^3$
hecto	Greek <i>hekatón</i> , “hundred”	h	$10^2$
deka	Greek <i>deka</i> , “ten”	da	$10^1$
deci	Latin <i>decimus</i> , “tenth”	d	$10^{-1}$
centi	Latin <i>centum</i> , “hundred”	c	$10^{-2}$
milli	Latin <i>mille</i> , “thousand”	m	$10^{-3}$
micro	Latin <i>micro-</i> (Greek <i>mikros</i> ), “small”	$\mu$	$10^{-6}$
nano	Latin <i>nanus</i> (Greek <i>nanos</i> ), “dwarf”	n	$10^{-9}$
pico	Spanish <i>pico</i> , “a bit,” Italian <i>piccolo</i> , “small”	p	$10^{-12}$
femto	Danish-Norwegian <i>femten</i> , “fifteen”	f	$10^{-15}$
atto	Danish-Norwegian <i>atten</i> , “eighteen”	a	$10^{-18}$
zepto	Latin <i>septem</i> , “seven”	z	$10^{-21}$
yocto	Greek or Latin <i>octo</i> , “eight”	y	$10^{-24}$





# Decline Curve Evaluation

The *decline curve method* uses production data to fit a decline curve and estimate future oil production. The three most common forms of decline curves are exponential, hyperbolic, and harmonic. It is assumed that the production will decline on a reasonably smooth curve, and so allowances must be made for wells shut in and production restrictions.

The curve can be expressed mathematically or plotted on a graph to estimate future production. It has the advantage of (implicitly) including all reservoir characteristics. It requires a sufficient history to establish a statistically significant trend, ideally when production is not curtailed by regulatory or other artificial conditions.



# Delivery Point

The delivery point (receipt point) is the point where natural gas is transferred from one party to another. The city gate is the delivery point for a pipeline or transportation company because this is where the gas is transferred to the local distribution company (LDC).

Distribution is the final step in delivering natural gas to customers. While some large industrial, commercial, and electric generation customers receive natural gas directly from high-capacity interstate and intrastate pipelines (usually contracted through natural gas marketing companies), most other users receive natural gas from their local gas utility, also called a local distribution company, which is a regulated utility involved in the delivery of natural gas to consumers within a specific geographic area. There are two basic types of natural gas utilities: those owned by investors, and public gas systems owned by local governments.

Local distribution companies typically transport natural gas from delivery points located on interstate and

intrastate pipelines to households and businesses through thousands of miles of small-diameter distribution pipe. The delivery point where the natural gas is transferred from a transmission pipeline to the local gas utility is often termed the *city gate*, and is an important market center for the pricing of natural gas in large urban areas. Typically, utilities take ownership of the natural gas at the city gate, and deliver it to each individual customer's meter. This requires an extensive network of small-diameter distribution pipe.

Because of the transportation infrastructure required to move natural gas to many diverse customers across a reasonably wide geographic area, distribution costs typically make up about half of natural gas costs for households and small-volume customers. While large pipelines can reduce unit costs by transmitting large volumes of natural gas, distribution companies must deliver relatively small volumes to many more different locations.



# Density, Specific Gravity, and API Gravity

Density is the mass (or weight) of a unit volume of any substance at a specified temperature. The *density* and *specific gravity* of crude oil are two properties that have found wide use in the industry for preliminary assessment of the character and quality of crude oil (Table 1).

*Density* is the mass of a unit volume of material at a specified temperature and has the dimensions of grams per cubic centimeter (a close approximation to grams per milliliter). In the SI system of units, the ratio of the density of a substance to the density of water at 15 °C is known as the *specific gravity (relative density)* (Table 2). Various units of density, such as kg/m<sup>3</sup>, lb-mass/ft<sup>3</sup>, and g/cm<sup>3</sup>, are commonly used. In addition, molar densities or the density divided by the molecular weight is often specified. *Specific gravity* is the ratio of the mass of a volume of the substance to the mass of the same volume of water and is dependent on two temperatures, those at which the masses of the sample and the water are measured.

$$SG_{oil} = \rho_{oil} / \rho_{water}$$

When the water temperature is 4 °C (39 °F), the specific gravity is equal to the density in the centimeter-gram-second (cgs) system, since the volume of 1 g of water at that temperature is, by definition, 1 ml. Thus the density of water, for example, varies with temperature, and its specific gravity at equal temperatures is always unity. The standard temperatures for a specific gravity in the petroleum industry in North America are 60/60 °F (15.6/15.6 °C).

In the early years of the petroleum industry, density was the principal specification for petroleum and refinery products; it was used to give an estimation of the gasoline and, more particularly, the kerosene present in the crude oil. However, the derived relationships between the density of petroleum and its fractional composition were valid only if they were applied to a certain type of petroleum and lost some of their significance when applied to different types

**Table 1** Density of petroleum and petroleum products.

Petroleum product	Density
Petroleum (light crude oil)	0.8505
Natural gas liquids	0.6502
Additives	0.7893
Refinery gas	0.6975
Ethane	0.3113
LPG	0.5625
Naphtha	0.718
Motor gasoline	0.7449
Aviation gasoline	0.7172
Gasoline type jet fuel	0.7699
Kerosene type jet fuel	0.797
Kerosene	0.8036
Gas/diesel oil	0.8397
Fuel oil (including Bunker C oil)	0.9471
White spirit	0.7699
Lubricating oil	0.891
Asphalt	1.0132
Paraffin wax	0.8654
Petroleum coke	0.9654

**Table 2** Specific gravity and density of methane relative to air and water.

Gas Specific Gravity: 0.55 to 0.64 (air = 1.00)
Specific Gravity of Liquefied Natural Gas: 0.42 to 0.46 (water = 1.00)
Gas Density (varies slightly): 0.0438 lb/ft <sup>3</sup>

of petroleum. Nevertheless, density is still used to give a rough estimation of the nature of petroleum and petroleum products. Although density and specific gravity are used extensively, the API (American Petroleum Institute) gravity is the preferred property. This property was derived from the Baumé scale:

$$\text{Degrees Baumé} = (140/\text{sp gr @ } 60/60 \text{ }^\circ\text{F}) - 130$$

However, a considerable number of hydrometers calibrated according to the Baumé scale were found at an early period to be in error by a consistent amount, and this led to the adoption of the equation:

$$\text{Degrees API} = (141.5/\text{sp gr @ } 60/60 \text{ }^\circ\text{F}) - 131.5$$

The specific gravity of petroleum usually ranges from about 0.8 (45.3° API) for the lighter crude oils to over 1.0 (less than 10° API) for heavy crude oil and bitumen.

Specific gravity is influenced by the chemical composition of petroleum, but quantitative correlation is difficult to establish. Nevertheless, it is generally recognized that increased amounts of aromatic compounds result in an increase in density, whereas an increase in saturated compounds results in a decrease in density. Indeed, it is also possible to recognize certain preferred trends between the density of petroleum and one or another of the physical properties. For example, an approximate correlation exists between the density (API gravity) and sulfur content, Conradson carbon residue, viscosity, and nitrogen content.

The variation of crude oil density with temperature, effectively the coefficient of expansion, is a property of great technical importance, since most petroleum products are sold by volume and specific gravity is usually determined at the prevailing temperature (21 °C, 70 °F) rather than at the standard temperature (60 °F, 15.6 °C). For most chemical compounds (i.e., those that are solid or liquid), the density is measured relative to water (1.00). For gases, the density is more likely to be compared to the density of air (also given the number 1.00 but this is arbitrary and bears no relationship to the density of water). As a comparison, the density of liquefied natural gas (LNG) is approximately 0.41 to 0.5 kg/L, depending on temperature, pressure and composition; in comparison the density of water is 1.0 kg/L.

The density of any gas compared to the density of air is the *vapor density* and is a very important characteristic of the constituents of natural gas and natural gas constituents. Put simply, if the constituents of natural gas are less

dense (lighter) than air, they will dissipate into the atmosphere, whereas if the constituents of natural gas are denser (heavier) than air, they will sink and be less likely to dissipate into the atmosphere.

Of the hydrocarbon constituents of natural gas, methane is the only one that is less dense than air. The statement is often made that *natural gas is lighter than air*. This statement often arises because of the continued insistence by engineers and scientists that the properties of a mixture are determined by the mathematical average of the properties of the individual constituents of the mixture. Such mathematical bravado and inconsistency of thought is *detrimental to safety* and needs to be qualified. Relative to air, methane is less dense but the other hydrocarbon constituents of unrefined natural gas (i.e., ethane, propane, butane, etc.) are denser than air (Table 2). Therefore, should a natural gas leak occur in field operations, especially where the natural gas contains constituents other than methane, only methane dissipates readily into the air, whereas the other hydrocarbon constituents that are heavier than air do not readily dissipate into the atmosphere. This poses considerable risk if these constituents of natural gas accumulate or pool at ground level when it has been erroneously assumed that natural gas is lighter than air.

Gas density is defined as mass per unit volume and so can also be derived and calculated from the real gas law:

$$\rho_g = \frac{m}{V} = \frac{PM}{ZRT}$$

Knowing that the molecular weight of gas is the product of specific gravity and molecular weight of air and that the value of  $R$  is 10.73 in field units [8.314 in SI units], we can write the equation for density as:

$$\rho_g = 2.7 \frac{P\gamma_g}{ZT}$$

where  $\rho_g$  is in lbm/ft<sup>3</sup>,  $P$  is in psia, and  $T$  is in °R. Alternately:

$$\rho_g = 3.49 \frac{P\gamma_g}{ZT}$$

where  $\rho_g$  is in kg/m<sup>3</sup>,  $P$  is in kPa, and  $T$  is in °K.

The density can also be written as:

$$\rho_g = 0.0764 \frac{\gamma_g}{B_g}$$

where  $\rho_g$  is in lbm/ft<sup>3</sup> and  $B_g$  is in ft<sup>3</sup>/SCF. Alternately,

$$\rho_g = 1.224 \frac{\gamma_g}{B_g}$$

# Density-Boiling Point Constant

The density-boiling point constant (DTC) is based on the finding that a series of points aligned on a straight line is obtained when the API gravity is used versus the logarithm of 50% ASTM temperature of fractions from a same oil.

$$\text{DTC} = \frac{{}^{\circ}\text{API} - 68.0 \log T_{50\%}}{1 - 0.703 \log T_{50\%}}$$





# Determining Depreciation

There are several methods for determining depreciation for a given period of time. The *straight-line method* is widely used in the oil industry – in this method, it is assumed that the value of the asset decreases linearly with time. The variables are:

$d$  = annual depreciation rate (\$/year)

$V_o$  and  $V_s$  = original value and salvage values of asset respectively (\$)

$n$  = service life (years)

Thus:

Annual depreciation cost = (depreciable capital)/ $n$

$$d = (V_o - V_s)/n$$

The asset value  $V_a$  at year  $a$ , is:

$$V_a = V_o - (a) (d)$$



# Dew Point Temperature and Pressure

The *dew point pressure* ( $P_d$ ) is the pressure at which the first condensate liquid comes out of solution in a gas condensate. Thus, the dew point curve is the curve that separates the pure gas phase from the two-phase region and represents the pressure and temperature at which the first liquid droplet is formed out of the gas phase.

Many gas condensate reservoirs are saturated at initial conditions, meaning that the dew point is equal to the initial reservoir pressure. Condensate dissolution is called retrograde condensation because this is counter to the behavior of pure substances, which vaporize when the pressure drops below the saturation pressure under isothermal (constant temperature) conditions.

The *dew point temperature* is a measure of how much water vapor there is in a gas. Water has the property of being able to exist as a liquid, solid, or gas under a wide range of conditions. To understand the behavior of water vapor, it is first useful to consider the general behavior of gases. In any mixture of gases, the total pressure of the gas is the sum of

the partial pressures of the component gases. This is Dalton's law and it is represented as follows:

$$P_{\text{total}} = P_1 + P_2 + P_3 \dots \text{etc.}$$

The quantity of any gas in a mixture can be expressed as a pressure.

The major components of air are nitrogen, oxygen, and water vapor, so total atmospheric pressure is composed of the partial pressures of these three gases. While nitrogen and oxygen exist in stable concentrations, the concentration of water vapor is highly variable and must be measured to be determined. The maximum partial pressure of water vapor is strictly a function of temperature. For example, at 20 °C (68 °F), the maximum partial pressure of water vapor is 23.5 mbar. The value of 23.5 mbar is said to be the *saturation vapor pressure* at 20°C (68 °F). In a 20 °C (68 °F), *saturated environment*, the addition of more water vapor results in the formation of condensation. This condensation phenomenon can be exploited to measure water vapor content.



# Dielectric Constant

The *dielectric constant*,  $\epsilon$ , of a substance may be defined as the ratio of the capacity of a condenser with the material between the condenser plates  $C$  to that with the condenser empty and under vacuum  $C_0$ :

$$\epsilon = C/C_0$$

The dielectric constant of petroleum and petroleum products may be used to indicate the presence of various constituents, such as asphaltene constituents, resins, or oxidized materials. Furthermore, the dielectric constant of petroleum

**Table** Dielectric constants of selected hydrocarbons and petroleum products.

Material	°C	°F	Dielectric constant
n-Pentane		68	1.83
n-Hexane	0	32	1.918
	20	68	1.890
	60	140	1.817
n-Heptane	0	32	1.958
	20	68	1.930
	60	140	1.873
n-Octane	20	68	2.00
Iso-octane	20	68	1.94
Benzene	10	50	2.296
	20	68	2.283
	60	140	2.204
Toluene	20	68	2.39
Ethyl benzene	20	68	2.50
	24	76	3.00
o-Xylene	20	68	2.57
m-Xylene	20	68	2.37
p-Xylene	20	68	2.30

products that are used in equipment, such as condensers, may actually affect the electrical properties and performance of that equipment (ASTM D877).

The dielectric constant of hydrocarbons and hence most crude oils and their products is usually low and decreases with an increase in temperature. It is also noteworthy that for hydrocarbons, hydrocarbons fractions, and products the dielectric constant is approximately equal to the square of the refractive index. Polar materials have dielectric constants greater than the square of the refractive index.

Material	°C	°F	Dielectric constant
Cyclohexane	20	68	2.055
Petroleum	20	68	2.10
Petroleum products LPG			1.6–1.9
Gasoline	20	68	1.8–2.0
Kerosene	20	68	2.0–2.2
Lubricating oil	20	68	2.1–2.6
Asphalt	24	75	2.60
Heavy oil	21	70	3.00

**Table** Relationship of dielectric constant to refractive index.

Material	Refractive Index, $n$	$n^2$	Dielectric Constant
Benzene	1.501	2.25	2.283
Cyclohexane	1.427	2.04	2.055
n-Hexane	1.375	1.89	1.89
n-Heptane	1.388	1.93	1.933
Kerosene	1.449	2.1	2.135
Paraffin oil	1.481	2.19	2.195
Vaseline	1.48	2.19	2.078



## Dielectric Loss and Power Factor

A condenser insulated with an ideal dielectric shows no dissipation of energy when an alternating potential is applied. The charging current, technically termed the *circulating current*, lags exactly 90 in phase angle behind the applied potential, and the energy stored in the condenser during each half-cycle is completely recovered in the next. No real dielectric material exhibits this ideal behavior; that is, some energy is dissipated under alternating stress and appears as heat. Such a lack of efficiency is broadly termed *dielectric loss*.

The measure of the dielectric loss is the power factor. This is defined as the factor  $k$  in the relation:

$$k = W/EI$$

$W$  is the power in watts dissipated by a circuit portion under voltage  $E$  and passing current  $I$ .

From ac theory, the power factor is recognized as the cosine of the phase angle between the voltage and current where a pure sine wave form exists for both; it increases with a rise in temperature. When an insulating material serves as the dielectric of a condenser the power factor is an intrinsic property of the dielectric. For practical electrical equipment, low-power factors for the insulation are of course always desirable; petroleum oils are generally excellent in this respect, having values of the order of 0.0005, comparable with fused quartz and polystyrene resins. The power factor of pure hydrocarbons is extremely small. Traces of polar impurities, however, cause a striking increase. All electrical oils, therefore, are drastically refined and handled with care to avoid contamination; insoluble oxidation products are particularly undesirable.





# Diesel Index

The presence of presence of paraffin hydrocarbons in diesel may be related by the aniline point, which is the temperature at which aniline solubilizes the fuel in equal point, which is the temperature at which aniline solubilizes the fuel in equal amount and a homogeneous mixture results. The greater the paraffin content, the higher will be the aniline point. Also, API gravity of oil increases as the paraffin content rises. With the help of these properties diesel index (D.I.) is given as:

$$DI = (API \times \text{Aniline point in } ^\circ F)/100$$

The diesel index has been correlated with cetane number and it has been found that the diesel index is directly proportional to cetane number. The cetane number is thus obtained from the diesel index. The value of diesel index should be at least 45.



# Dipole Moment

The dipole moment ( $\mu$ ) is the mathematical product of the distance between the centers of charge of two atoms multiplied by the magnitude of that charge. The unit of measurement is the Debye.

$$\mu = Q r$$

$Q$  is the electrical charge that is separated by the distance  $r$ .



# Distillation

For separation by distillation, the selection of a chemical or physical property difference is very important. Factors influencing this are (1) the physical property, (2) the magnitude of the property difference, (3) the amount of material to be distilled, (4) the relative properties of different species or components, (5) the purity required, and (6) the chemical behavior of the material during distillation and its corrosiveness. A measure of the ease of separation of one component *A* from another *B* is known as the separation factor, SF, and is defined as:

$$SF = [C_A/C_B]_{\text{Top product}} / [C_A/C_B]_{\text{Bottom product}}$$

*C* is the concentration and a high value of the separation factor is indicative of a relatively easy separation.

In order to separate a mixture of natural gas liquids (NGLs), such as propane plus, as a bottom product, then there must be a difference in boiling point between the top product (ethane) and the bottom product. This difference is an indication of the degree of difficulty of separation or the value of the separation factor. As an equilibration separation process, SF should be much greater than unity for ethane to concentrate in the top and propane plus to concentrate in the bottom.

A difficult separation implies the following: (1) a higher number of distillation trays, which affects column size, (2) a higher reflux ratio, which influences pump size and power consumption, and (3) additional reboiler heat duty, which influences reboiler size and energy consumption (Table 1).

Since TBP distillation is both tedious and time-consuming in comparison with the ASTM method, a correlation has been developed to convert ASTM to TBP distillation while at the same time achieving the benefit of

the detailed separation of TBP with the little effort of the ASTM distillation. Thus:

$$TBP = a(\text{ASTM D86})^b$$

In the equation, *a* and *b* are constants varying with percent of liquid sample distilled (Table 2). TBP is true boiling point temperatures at 0, 10, 30, 50, 70, 90, and 95% v/v in degrees Rankin. ASTM D86 is the observed ASTM D86 temperatures at corresponding volume percent distilled, in degrees Rankin.

**Table 1** Tray distribution in an atmospheric distillation column.

Zone	Number of trays
Overhead product to kerosene	10
Kerosene to light gas oil	8
Light gas oil to heavy gas oil	6
Heavy gas oil to flash zone	6
Flash zone to atmospheric residue	6
Pumparounds	3-4

**Table 2** Constants for converting ASTM distillation data to TBP distillation data.

Volume % distilled	<i>a</i>	<i>b</i>
0	0.9167	1.0019
10	0.5277	1.0900
30	0.7429	1.0425
50	0.8920	1.0176
70	0.8705	1.0226
90	0.9490	1.0110
95	0.8008	1.0355



## Distillation – Flooding

A common problem that can occur in distillation columns is flooding. When the column is operating normally, liquid flows downward over the structured packing countercurrent to the upward flowing vapor. The upward flow of the vapor exerts an aerodynamic drag on the falling liquid and this drag force acts in opposition to the force of gravity and slows the flow of the falling liquid. When the relative flow rates of the vapor and liquid are such that the drag force is greater than or equal to the gravity force; then, the liquid stops flowing down the column. This condition is called flooding and can begin at any vertical location in the column.

In this condition, there has been a change insofar as the vapor is no longer the continuous phase – the liquid is the continuous phase with bubbles of vapor rising through it. The rising bubbles tend to drag a lot of liquid upward, thus causing undesirable axial mixing in the column. The net effect is the distillation column stops generating a separation and the top product and the bottom product become similar in composition to the feed stream. The bubbles have

a distribution of sizes and tend to nucleate, grow, agglomerate, and break apart randomly. As a result, bubble flow tends to be a random process. If the pressure drop were measured across the packing, it is expected this random bubble flow process would contribute a broad spectrum of effects which are not present during normal operation.

The equation for the flooding factor (F) is:

$$F = \mu(\rho_{vap})^{0.5}$$

In this equation,  $\mu$  is superficial velocity of the vapor and  $\rho_{vap}$  is the density of the vapor. On the other hand, the flooding velocity ( $u_f$ ) can be calculated from:

$$v_f = K_1[(\rho_L - \rho_v)/\rho_v]^{1/2}$$

where  $v_f$  is the flooding velocity in meters/sec,  $K_1$  is a coefficient obtained from a chart,  $\rho_L$  is the liquid density, and  $\rho_v$  is the vapor density.





## Distillation – Gap-Overlap

The gap-overlap method is used to determine separation effectiveness in crude distillation. The gap-overlap is a measure of separation between two adjacent products from the atmospheric crude tower. The higher boiling fraction is the lower product and has the higher molecular weight. The lower boiling fraction is the upper product and has the lower molecular weight. Both gap and overlap are defined by:

$$\text{gap or overlap}_{5/95} = \text{ASTMD86}_{5\text{vol}\%} \text{ Temp of Heavy Cut} \\ - \text{ASTMD86}_{95\text{vol}\%} \text{ Temp of Light Cut}$$

A positive number from this equation indicates a gap while a negative number indicates an overlap – the more positive the value of the number, the better the separation between the two streams.

The definition used here is based on an ASTM D86 distillation with a 5/95 gap because it uses the 5 volume percent point of the heavier product and the 95 volume percent point of the lighter product. However, various plants use alternate percent points, weight percent instead of volume percent, or use different ASTM distillation methods. All these variations are valid if done consistently and historical comparisons or comparisons between different units must use a consistent basis.



# Drilling Fluid

The drilling fluid is a very important element of the drilling operation and the importance arises from the many essential functions the fluid serves, such as (1) transporting the cuttings from the bottom of the hole to the surface, (2) cooling of the bit and lubrication of the drill string, (3) exerting hydrostatic pressure to overbalance the pressure of the formation and thus prevent flow of formation fluids into the well, (3) supporting the walls of the hole to prevent it from collapsing inward, and (4) enhancing drilling by its jetting action through the bit nozzles. The drilling fluid can be prepared in different formulations to provide the desired properties (density, viscosity, and filtration) under the bottom hole conditions.

The simplest drilling fluid is a mixture of water and clay, often referred to as mud but more complex compositions are used, especially when additives are employed (Table). The drilling fluid in the drilling process can be seen as the equivalent to the blood in the human body; the mud pump is the heart, the drilled out shale (cuttings) represent the slag products, and at the surface, we find the mud cleaning system, which corresponds to the kidney and the lungs. In the mud cleaning system, the cuttings are removed by means of a sieve, the shale shaker. Mud is basically a fluid (water or oil) circulated to bring cuttings out of the wellbore. Two important qualities of the fluid that are needed for mud to achieve all its tasks are viscosity and density.

For example, water and oil has a viscosity of around 1 cP (centipoise), which is far too little to transport the cuttings out. A component is needed to increase the viscosity. The main viscosity modifiers are clay minerals and polymers. In addition, water and oil have a density of around 1 kg/liter, which in most cases is too little to counter high pore pressure. It may in fact become necessary to increase it to twice the pressure of a water column. The main density modifier is barite ( $\text{BaSO}_4$ ), a mineral often found as evaporites (with a specific density of 4.2 kgm/liter), or, soluble salts (brines). Clay minerals and polymer derivatives react with water,

while barite does not, and is therefore referred to as the inert phase.

For mud to manage its many tasks, a broad range of different fluid systems have been developed – nine distinct mud systems are defined here. The first seven are water-based, while the eighth is oil-based. The ninth category is a specialized one in which air or gas is the continuous fluid. The nine categories are:

1. *Non-dispersed*. These may consist of spud muds, natural muds and other lightly treated systems generally used for shallow wells or top hole drilling.
2. *Dispersed*. At greater depths or where hole conditions may be problematic, muds are often dispersed, typically by means of lignosulphonates or other deflocculants. These and similar products are also effective filtrate reducers.
3. *Calcium treated*. Divalent cations such as calcium and magnesium, when added to a mud, inhibit the swelling of formation clays and shale, and are therefore added to control sloughing shale, hole enlargement and to prevent formation damage. Hydrated lime, gypsum (calcium sulphate) and calcium chloride are principal ingredients of calcium systems. *Gyp systems* (note: Gyp = gypsum) usually have a pH of 9.5 to 10.5 and an excess gyp concentration of 2 to 4 lb/bbl; *Lime systems* have an excess lime concentration of 1 to 15 lb/bbl and a pH of 11.5 to 12.0.
4. *Polymer*. Muds incorporating long-chain, high-molecular-weight chemicals are effective in increasing viscosity, flocculating muds, reducing filtrate loss and stabilizing the formation. Various types of polymers are available for this purpose, including Bentonite extenders. Bio polymers and cross-linked polymers are also used and have good

- shear-thinning properties at low concentrations.
5. *Low solids*. This includes systems in which the amount and type of solids are controlled. Total solids should not range higher than about 6 to 10 by volume (and clay < 3 by volume). One primary advantage of low-solids systems is that they significantly improve the rate of penetration.
  6. *Saturated salt*. Include several groups: *Saturated salt systems* have a chloride ion concentration of 189000 ppm. *Saltwater systems* have a chloride content from 6 000 to 189000 ppm, and at its lower level are usually referred to as *brackish* or *seawater systems*.
  7. *Workover*. Completion and workover fluids are specialized systems designed to minimize formation damage, and be compatible with acidizing and fracturing operations (acid soluble) and capable of inhibiting swelling clays that reduce formation permeability. Density is obtained through dissolved salt to avoid long-term settling.
  8. *Oil/synthetic*. Oil-based fluids are used for high-temperature wells, deviated holes and wells where pipe sticking and hole stabilization is a problem. They consist of two types of systems:
    - a. *Invert emulsion muds* are water-in-oil fluids and have water as the dispersed phase and oil as the continuous phase. They may contain up to 50% v/v water in the liquid phase.
    - Emulsifier (commonly fatty acids amine derivatives, high-molecular-weight soaps), and water concentrations are varied to control rheological and electrical stability;
    - b. *Synthetic fluids* are designed to duplicate the performance of oil-based muds, without the environmental hazards. Primary types of synthetic fluids are esters, poly alpha olefins and food grade paraffin. They are environmentally friendly, can be discharged offshore and are non-sheening and biodegradable.
  9. *Air, mist, foam and gas*. Four basic operations are included in this specialized category. These include:
    - a. Dry air drilling, which involves injecting dry air or gas into the wellbore at rates capable of achieving annular velocities that will remove cuttings;
    - b. Mist drilling involves injecting a foaming agent into the air stream, which mixes with produced water and lifts drill cuttings;
    - c. Stable foam uses chemical detergents and polymers and a foam generator to carry cuttings in fast-moving air stream;
    - d. Aerated fluids rely on mud with injected air (which reduces the hydrostatic head) to remove drilled solids from the wellbore.

**Table** Elemental composition of drilling fluid constituents.

Element	Water	Cuttings	Barite	Clay	Chrome-lignosulfonate	Lignite	Caustic
Aluminum	0.3	40,400	40,400	88,600	6,700	6,700	0.013
Arsenic	0.0005	3.9	34	3.9	10.1	10.1	0.039
Barium	0.01	158	590,000	640	230	230	0.26
Calcium	15	240,000	7,900	4,700	16,100	16,100	5,400
Cadmium	0.0001	0.08	6	0.5	0.2	0.2	0.0013
Chromium	0.001	183	183	8.02	40,030	65.3	0.00066
Cobalt	0.0002	2.9	3.8	2.9	5	5	0.00053
Copper	0.003	22	49	8.18	22.9	22.9	0.039
Iron	0.5	21,900	12,950	37,500	7,220	7,220	0.04
Lead	0.003	37	685	27.1	5.4	5.4	0.004
Magnesium	4	23,300	3,900	69,800	5,040	5,040	17,800
Mercury	0.0001	0.12	4.1	0.12	0.2	0.2	5
Nickel	0.0005	15	3	15	11.6	11.6	0.09
Potassium	2.2	13,500	660	2,400	3,000	460	51,400
Silicon	7	206,000	70,200	271,000	2,390	2,390	339
Sodium	6	3,040	3,040	11,000	71,000	2,400	500,000
Strontium	0.07	312	540	60.5	1030	1030	105

# Drilling Fluid Additives

Drilling fluid (sometimes referred to as *drilling mud*) is used to aid the drilling of boreholes into the earth and, consequently, is used while drilling wells for the recovery of crude oil and natural gas. The three main categories of drilling fluids are water-based muds (which can be dispersed and non-dispersed), non-aqueous muds, usually called oil-based mud, and gaseous drilling fluid, in which a wide range of gases can be used. The main functions of drilling fluids include (1) providing hydrostatic pressure to prevent formation fluids from entering into the well bore, (2) keeping the drill bit cool and clean during drilling, (3) carrying out drill cuttings, and (4) suspending the drill cuttings while drilling is paused and when the drilling assembly is brought in and out of the hole. The drilling fluid used for a particular job is selected to avoid formation damage and to limit corrosion.

Drilling fluid additives are specialty products that serve a specific need and the need is dependent upon the properties of the reservoir formation and the oil. Typically, additives are used for:

## *Alkalinity, pH control:*

Lime, caustic soda and bicarbonate of soda control the degree of acidity of a fluid.

## *Bactericides:*

Para formaldehyde, caustic soda, lime and starch preservatives are commonly used to reduce bacteria count.

## *Calcium removers:*

Caustic soda, soda ash, bicarbonate of soda and certain polyphosphates make up the majority of chemicals designed to prevent and overcome the contaminating effects of anhydrite, gypsum and calcium sulfate.

## *Corrosion inhibitors:*

Hydrated lime and amine salts are often added to check corrosion.

## *Defoamers:*

Products designed to reduce foaming action, particularly in brackish and saturated saltwater mud.

## *Emulsifiers:*

Surface active agents create a heterogeneous mixture of two liquids.

## *Filtrate reducers:*

Filtrate, or fluid loss reducers – such as Bentonite clays, CMC (sodium carboxyl methyl cellulose) and pre gelatinized starch – reduces the tendency of the liquid phase of the drilling fluid to pass into the formation.

## *Flocculants:*

Salt, hydrated lime, gypsum and sodium tetra phosphates are used to cause colloidal particles in suspension to group into bunches, or “flocks,” causing solids to settle out.

## *Foaming agents:*

Surfactants (foamers) permit air or gas drilling through water-bearing formations.

## *Lost circulation materials:*

Lost circulation additives plug the zone of loss in the formation.

*Lubricants:*

Oils, graphite, powder and soaps reduce torque and increase horsepower transmitted to the bit by reducing the coefficient of friction.

*Pipe-freeing agents:*

Detergents, soaps, oils and surfactants are intended to be spotted in an area of suspected pipe sticking to reduce friction, increase lubricity and inhibit formation swelling.

*Shale control inhibitors:*

Gypsum, sodium silicate and calcium lignosulfonates, as well as lime and salt, are used to control swelling or hydrous disintegration of shale.

*Surface active agents:*

Reduce the interfacial tension between contacting surfaces (such as water/oil, water/air, interfaces).

# E85 Fuel

E85 fuel is an alcohol fuel mixture containing 85% ethanol and 15% gasoline by volume (Table), and the current alternative fuel of choice of the U.S. government.

E85 has an octane rating higher than that of regular gasoline's typical rating of 87, or premium gasoline's 91-93. This allows it to be used in higher compression engines, which tend to produce more power per unit of displacement than their gasoline counterparts. One complication is that use of gasoline in an engine with a high enough compression ratio to use E85 efficiently would likely result in catastrophic failure due to

engine detonation, as the octane rating of gasoline is not high enough to withstand the greater compression ratios in use in an engine specifically designed to run on E85. Use of E85 in an engine designed specifically for gasoline would result in a loss of the potential efficiency that it is possible to gain with this fuel. Using E85 in a gasoline engine has the drawback of achieving lower fuel economy as more fuel is needed per unit air (stoichiometric fuel ratio) to run the engine in comparison with gasoline. This corresponds to a lower heating value (units of energy per unit mass) for E85 than gasoline.

**Table** Comparison of E85 and conventional gasoline.

Categories	Gasoline	E85
Chemical Structure	C <sub>4</sub> to C <sub>4</sub>	CH <sub>4</sub> CH <sub>4</sub> OH
Octane Number	85 to 94	100
Primary Fuel Source	Crude Oil	Corn, Grain, Agricultural Wastes
Energy Content (per gallon)	109,000 to 125,000 Btu	80,000 Btu
Energy Ratio compared to Gasoline	–	70%
Commercially Available Vehicles	All	Flexible Fuel Vehicles (can run on gas or E85) include cars, trucks, buses
Environmental Impact	harmful emissions, newer vehicles mitigate this problem	reduction in ozone forming emissions compared with gasoline
Energy Security Impact	low: most manufactured using imported crude	high: domestic, renewable
Fuel Availability	All stations	169 stations. 23 states, most stations in Midwest
Maintenance Issues		May require special lubricants
Safety	Relatively safe, not biodegradable, potential to pollute soil and water	Less dangerous than gasoline due to low evaporative speed; biodegradable





# Embrittlement

Embrittlement is the loss of ductility of a material, making it brittle. Various materials have different mechanisms of embrittlement.

- Hydrogen embrittlement: the effect of hydrogen absorption on some metals and alloys.
- Sulfide stress cracking: the embrittlement caused by absorption of hydrogen sulfide.
- Liquid metal embrittlement (LME): the embrittlement caused by liquid metals.
- Metal-induced embrittlement (MIE): the embrittlement caused by diffusion of atoms of metal, either solid or liquid, into the material.
- Other forms of embrittlement are caused by neutron radiation, overheating or aging of plastics, and oxidation of asphalt pavement that results in cracks and pavement deterioration.



# Embrittlement – Hydrogen

During hydrogen embrittlement, hydrogen is introduced to the surface of a metal and individual hydrogen atoms diffuse through the metal. Because the solubility of hydrogen increases at higher temperatures, raising the temperature can increase the diffusion of hydrogen. When assisted by a concentration gradient where there is significantly more hydrogen outside the metal than inside, hydrogen diffusion can occur even at lower temperatures. These individual hydrogen atoms within the metal gradually recombine to form hydrogen molecules, creating pressure from within the metal. This pressure can increase to levels where the metal has reduced ductility, toughness, and tensile strength, up to

the point where it cracks open (*hydrogen-induced cracking*, or HIC).

Hydrogen embrittlement can occur during various manufacturing operations or operational use – anywhere that the metal comes into contact with atomic or molecular hydrogen. Processes that can lead to this include cathodic protection, phosphating, pickling, and electroplating. Other mechanisms of introduction of hydrogen into metal are galvanic corrosion, as well as chemical reactions with acids or other chemicals. One of these chemical reactions involves hydrogen sulfide in sulfide stress cracking (SSC), an important process for the crude oil and natural gas industries.



# Emulsion

An emulsion is a dispersion (droplets) of one liquid in another immiscible liquid. The phase that is present in the form of droplets is the dispersed or internal phase, and the phase in which the droplets are suspended is called the continuous or external phase.

For produced oilfield emulsions, one of the liquids is aqueous and the other is crude oil. The amount of water that emulsifies with crude oil varies widely from facility to facility and can be less than 1% v/v and even greater than 80% v/v.



# Enhanced Oil Recovery

Almost 70% of the total proven crude reserves will still be in the ground when production by standard techniques ceases to be economic. A successful *enhanced oil recovery process (tertiary oil recovery process)*, to supplement the present methods of pumping under natural forces, followed by a secondary water flood, is now an urgent research objective. Adsorption of surfactants on solids from aqueous solution is an important phenomenon both in tertiary oil recovery using micellar flooding. Successful immiscible oil displacement depends on the existence of very low interfacial tension between the oil and water phases. A value of about  $10^{-3}$  dyne/cm or less is required to mobilize the oil. The achievement and maintenance of low interfacial tensions during chemical flooding are important. Factors related to surfactant – polymer properties, interfacial tension, interaction between chemicals and rock are discussed. Practical surfactant flood systems are usually very complex. The present is surfactant, oil, water, electrolyte and a thickening agent for viscosity control, plus co-surfactants and blocking agents to enhance or protect the main surfactant. Secondary oil recovery by inhibition of water is used to improve the oil recovery. This process is driven by capillary forces. The objectives of this review are to focus on the chemical flooding of oil reservoirs.

After the primary and secondary cycles of oil recovery, additives may be injected to drive out additional oil in the reservoir. The capillary pressure, or pressured difference across an oil/water interface spanning a pore, is given by:

$$P_c = 2\gamma \cos\theta/r$$

where  $\gamma$  is the oil/water interfacial tension,  $\theta$  is the contact angle, measured through the water phase at the point of oil/water /rock contact, and ( $r$ ) is the effective pore radius. The ratio of viscous forces to capillary force correlates wells with residual oil saturation and is termed the capillary number. One formulation of the capillary number is:

$$N_c = \eta c/\gamma\phi$$

where  $\eta$  and ( $v$ ) are the viscosity and velocity of the displacing fluid.

*Enhanced oil recovery (tertiary oil recovery)* is the incremental ultimate oil that can be recovered from a petroleum reservoir over oil that can be obtained by primary and secondary recovery methods. The viscosity (or the API gravity) of petroleum is an important factor that must be taken into account when heavy oil is recovered from a reservoir. In fact, certain reservoir types, such as those with very viscous crude oils and some low-permeability carbonate (limestone, dolomite, or chert) reservoirs, respond poorly to conventional secondary recovery techniques.

In these reservoirs it is desirable to initiate *enhanced oil recovery (EOR)* operations as early as possible. This may mean considerably abbreviating conventional secondary recovery operations or bypassing them altogether. Thermal floods using steam and controlled *in situ* combustion methods are also used. Thermal methods of recovery reduce the viscosity of the crude oil by heat so that it flows more easily into the production well. Thus tertiary techniques are usually variations of secondary methods with a goal of improving the *sweeping* action of the invading fluid.

Thus, enhanced oil recovery methods are designed to reduce the viscosity of the crude oil (i.e., to reduce the pour point of the crude oil relative to the temperature of the reservoir), thereby increasing oil production. Enhanced oil recovery methods are applied when secondary oil recovery techniques are no longer enough to sustain production.

Thermally enhanced oil recovery methods are tertiary recovery techniques that heat the oil and make it easier to extract. Steam injection is the most common form of this process and is used extensively to increase oil production. *In situ* combustion is another form of thermally enhanced oil recovery but instead of using steam to reduce the crude oil viscosity, some of the oil is burned to heat the surrounding oil. Detergents are also used to decrease oil viscosity.

A significant amount of laboratory research and field testing has been devoted to developing enhanced oil recovery

methods as well as defining the requirements for a successful recovery and the limitations of the various methods. The intent of enhanced oil recovery is to increase the effectiveness of oil removal from pores of the rock (*displacement efficiency*) and to increase the volume of rock contacted by injected fluids (*sweep efficiency*).

Enhanced oil recovery processes use *thermal*, *chemical*, or *fluid phase behavior* effects to reduce or eliminate the capillary forces that trap oil within pores, to thin the oil or otherwise improve its mobility or to alter the mobility of the displacing fluids. In some cases, the effects of gravity forces, which ordinarily cause vertical segregation of fluids of different densities, can be minimized or even used to advantage. The various processes differ considerably in complexity, the physical mechanisms responsible for oil recovery, and the amount of experience that has been derived from field application. The degree to which the enhanced oil recovery methods are applicable in the future will depend on development of improved process technology. It will also depend on improved understanding of fluid chemistry, phase behavior, and physical properties; and on the accuracy of geology and reservoir engineering in characterizing the physical nature of individual reservoirs.

*Chemical methods* include polymer flooding, surfactant (micellar or polymer and microemulsion) flooding, and alkaline flood processes.

*Thermal methods* for oil recovery have found most use when the oil in the reservoir has a high viscosity. For example, heavy oil is usually highly viscous (hence the use of the adjective *heavy*), with a viscosity ranging from approximately 100 centipoises to several million centipoises at the reservoir conditions. In addition, oil viscosity is also a function of temperature and API gravity. Thus for heavy crude oil samples with API gravity ranging from 4 to 21° API (1.04 to 0.928 kg/m<sup>3</sup>):

$$\log \log (\mu\sigma + \sigma) = A - B \log (T + 460)$$

In this equation,  $\mu$  is oil viscosity in cP,  $T$  is temperature in F,  $A$  and  $B$  are constants, and  $\sigma$  is an empirical factor used to achieve a straight-line correlation at low viscosity. This equation is usually used to correlate kinematic viscosity in centistokes, in which case an  $\sigma$  of 0.6 to 0.8 is suggested (dynamic viscosity in cP equals kinematic viscosity in cSt times density in g/ml).

An alternative equation for correlating viscosity data is:

$$\mu = ae^{b/T^*}$$

where  $a$  and  $b$  are constants, and  $T^*$  is the absolute temperature.

*Thermal enhanced oil recovery processes* add heat to the reservoir to reduce oil viscosity and/or to vaporize the oil. In both instances, the oil is made more mobile so that it can be more effectively driven to producing wells. In addition to

adding heat, these processes provide a driving force (pressure) to move oil to producing wells.

Thermal recovery methods include cyclic steam injection, steam flooding, and in-situ combustion. The steam processes are the most advanced of all enhanced oil recovery methods in terms of field experience and thus have the least uncertainty in estimating performance, provided that a good reservoir description is available. Steam processes are most often applied in reservoirs containing viscous oils and tars, usually in place of rather than following secondary or primary methods. Commercial application of steam processes has been underway since the early 1960s. *In situ* combustion has been field tested under a wide variety of reservoir conditions, but few projects have proven economical and advanced to commercial scale.

*In situ combustion* is normally applied to reservoirs containing low-gravity oil but has been tested over perhaps the widest spectrum of conditions of any enhanced oil recovery process. In the process, heat is generated within the reservoir by injecting air and burning part of the crude oil. This reduces the oil viscosity and partially vaporizes the oil in place, and the oil is driven out of the reservoir by a combination of steam, hot water, and gas drive. *Forward combustion* involves movement of the hot front in the same direction as the injected air. *Reverse combustion* involves movement of the hot front opposite to the direction of the injected air.

The relatively small portion of the oil that remains after these displacement mechanisms have acted becomes the fuel for the *in situ* combustion process. Production is obtained from wells offsetting the injection locations. In some applications, the efficiency of the total *in situ* combustion operation can be improved by alternating water and air injection. The injected water tends to improve the utilization of heat by transferring heat from the rock behind the combustion zone to the rock immediately ahead of the combustion zone.

The performance of *in situ* combustion is predominantly determined by the following four factors:

1. The quantity of oil that initially resides in the rock to be burned.
2. The quantity of air required to burn the portion of the oil that fuels the process.
3. The distance to which vigorous combustion can be sustained against heat losses.
4. The mobility of the air or combustion product gases.

In many field projects, the high gas mobility has limited recovery through its adverse effect on the sweep efficiency of the burning front. Because of the density contrast between air and reservoir liquids, the burning front tends to override the reservoir liquids. To date, combustion has been most effective for the recovery of viscous oils in moderately thick reservoirs in which reservoir dip and continuity provide effective gravity drainage or operational factors permit close well spacing.



Using combustion to stimulate oil production is regarded as attractive for deep reservoirs and, in contrast to steam injection, usually involves no loss of heat. The duration of the combustion may be short (<30 days) or more prolonged (approximately 90 days), depending upon requirements. In addition, backflow of the oil through the hot zone must be prevented or coking occurs.

In *modified in situ extraction* processes, combinations of *in situ* and mining techniques are used to access the reservoir. A portion of the reservoir rock must be removed to

enable application of the *in situ* extraction technology. The most common method is to enter the reservoir through a large-diameter vertical shaft, excavate horizontal drifts from the bottom of the shaft, and drill injection and production wells horizontally from the drifts. Thermal extraction processes are then applied through the wells.

When the horizontal wells are drilled at or near the base of the tar sand reservoir, the injected heat rises from the injection wells through the reservoir, and drainage of produced fluids to the production wells is assisted by gravity.



# Environmental Regulations

Extracting natural gas or crude oil from tight formations poses a number of risks to the environment and requires large quantities of nearby water. Much of this water is needed for fracturing the tight formation to allow the gas and/or oil

to flow to the surface. Environmental impacts associated with natural gas and crude oil development occur at the global and local levels since resources in tight formations are not always located where water is abundant.

**Table** Examples of environmental regulation that influence the petroleum industry.

Resource Conservation and Recovery Act (RCRA)	Regulates management, treatment, and disposal of hazardous wastes.
Safe Drinking Water Act	Regulates injection wells that may contaminate freshwater aquifers.
Clean Water Act	Regulates activities that may pollute surface waters.
Comprehensive Environmental Response, Compensation, and Liability Act (CERCLA)	Regulates cleanup of existing hazardous waste sites.
Superfund Amendments and Reauthorization Act (SARA)	Regulates reporting of storage and use of hazardous chemicals.
Clean Air Act	Regulates activities that emit air pollutants.
Oil Pollution Act	Regulates emergency response plans for oil discharges.
Toxic Substances Control Act	Regulates testing of new chemicals.
Endangered Species Act	Regulates actions that jeopardize endangered or threatened species.
Hazard Communication Standard	Regulates the availability of information on chemical hazards to employees.
National Environmental Policy Act (NEPA)	Regulates actions of federal government that may result in environmental impacts.



# Evaporation

Evaporation is the process by which molecules in a liquid state spontaneously become gaseous) and is the opposite of condensation. Generally, evaporation can be seen by the gradual disappearance of a liquid when exposed to a significant volume of gas.

On average, the molecules do not have enough energy to escape from the liquid, or else the liquid would turn into vapor quickly. When the molecules collide, they transfer energy to each other in varying degrees, based on how they collide. Sometimes the transfer is so one-sided for a molecule near the surface that it ends up with enough energy to escape.

Liquids that do not evaporate visibly at a given temperature in a given gas (e.g., cooking oil at room temperature) have molecules that do not tend to transfer energy to each other in a pattern sufficient to frequently give a molecule the heat energy necessary to turn into vapor.

If evaporation takes place in a closed vessel, the escaping molecules accumulate as a vapor above the liquid. Many of the molecules return to the liquid, with returning molecules becoming more frequent as the density and pressure of the vapor increases. When the process of escape and return reaches an equilibrium, the vapor is *saturated*, and no further change in either vapor pressure and density or liquid temperature will occur. For a system consisting of vapor and liquid of a pure substance, the equilibrium state is directly related to the vapor pressure of the substance (Clausius-Clapeyron equation):

$$\ln\left(\frac{P_2}{P_1}\right) = -\frac{\Delta H_{\text{vap}}}{R}\left(\frac{1}{T_2} - \frac{1}{T_1}\right)$$

$P_1$ ,  $P_2$  are the vapor pressures at temperatures  $T_1$ ,  $T_2$  respectively,  $\Delta H_{\text{vap}}$  is the enthalpy of vaporization,  $R$  is the universal gas constant.

The ability for a molecule of a liquid to evaporate is largely based on the amount of kinetic energy an individual

particle may possess. Even at lower temperatures, individual molecules of a liquid can evaporate if they have more than the minimum amount of kinetic energy required for vaporization.

The factors which influence the rate of evaporation are:

1. Concentration of the substance evaporating in the air – if the air already has a high concentration of the substance evaporating, then the given substance will evaporate more slowly.
2. Concentration of other substances in the air – if the air is already saturated with other substances, it can have a lower capacity for the substance evaporating.
3. Concentration of other substances in the liquid (impurities) – if the liquid contains other substances, it will have a lower capacity for evaporation.
4. Flow rate of air – if fresh air is moving over the substance all the time, then the concentration of the substance in the air is less likely to increase with time, thus encouraging faster evaporation.
5. Inter-molecular forces – the stronger the forces keeping the molecules together in the liquid state, the more energy one must get to escape.
6. Pressure – in an area of less pressure, evaporation happens faster because there is less exertion on the surface keeping the molecules from launching themselves.
7. Surface area – a substance which has a larger surface area will evaporate faster as there are more surface molecules which are able to escape.
8. Temperature – if the liquid is hotter, evaporation is more rapid.
9. Density – the higher the density, the slower a liquid evaporates.



# Expansion and Contraction of Solids

The thermal expansion and contraction of solids can also have safety implications. For a given material the amount of its linear expansion, or contraction, in one direction is directly related to temperature and its original size (i.e., length, diameter, circumference). Thus:

$$\text{change in length} = \alpha L \Delta t$$

In the equation,  $\alpha$  is the thermal coefficient of linear expansion,  $\Delta t$  is the change in temperature, and  $L$  is the original linear measurement.

Thus, unacceptable stresses can arise in rigid construction materials, in apparatus, equipment, and piping if subjected to large temperature fluctuations.





# Explosive Limits

The explosive limit of a gas or a vapor is the limiting concentration (in air) that is needed for the gas to ignite and explode. There are two explosive limits for any gas or vapor, the lower explosive limit (LEL) and the upper explosive limit (UEL). A fuel and oxygen (air) must exist in certain proportions, along with an ignition source, such as a spark or flame. The ratio of fuel and oxygen that is required varies with each combustible gas or vapor. The minimum concentration of a particular combustible gas or vapor necessary to support its combustion in air is the *lower explosive limit* (LEL) for that gas. Below this level, the mixture is too lean to burn. The maximum concentration of a gas or vapor that will burn in air is the *upper*

*explosive limit* (UEL). Above this level, the mixture is too to burn. The range between the lower explosive limit and the upper explosive limit is the flammable range for that gas or vapor.

Dusts also have upper and lower explosion limits, though the upper limits are hard to measure and of little practical importance. Lower explosive limits for many organic materials are in the range of 10 to 50 g/m<sup>3</sup>, which is much higher than the limits set for health reasons, as is the case for the lower explosive limit of many gases and vapors. Dust clouds of this concentration are hard to see through for more than a short distance, and normally only exist inside process equipment.

**Table** Lower and upper explosive limits for flammable gases and liquids.

Gas	LEL	UEL
Acetone	2.6	13.0
Acetylene	2.5	100.0
Acrylonitrile	3.0	17
Allene	1.5	11.5
Ammonia	15.0	28.0
Benzene	1.3	7.9
1,3-Butadiene	2.0	12.0
Butane	1.8	8.4
n-Butanol	1.7	12.0
1-Butene	1.6	10.0
Cis-2-Butene	1.7	9.7
Trans-2-Butene	1.7	9.7
Butyl Acetate	1.4	8.0
Carbon Monoxide	12.5	74.0
Carbonyl Sulfide	12.0	29.0

Gas	LEL	UEL
Chlorotrifluoroethylene	8.4	38.7
Cumene	0.9	6.5
Cyanogen	6.6	32.0
Cyclohexane	1.3	7.8
Cyclopropane	2.4	10.4
Deuterium	4.9	75.0
Diborane	0.8	88.0
Dichlorosilane	4.1	98.8
Diethylbenzene	0.8	–
1,1-Difluoro-1-Chloroethane	9.0	14.8
1,1-Difluoroethane	5.1	17.1
1,1-Difluoroethylene	5.5	21.3
Dimethylamine	2.8	14.4
Dimethyl Ether	3.4	27.0
2,2-Dimethylpropane	1.4	7.5
Ethane	3.0	12.4

(Continued)

Table Cont.

Gas	LEL	UEL
Ethanol	3.3	19.0
Ethyl Acetate	2.2	11.0
Ethyl Benzene	1.0	6.7
Ethyl Chloride	3.8	15.4
Ethylene	2.7	36.0
Ethylene Oxide	3.6	100.0
Gasoline	1.2	7.1
Heptane	1.1	6.7
Hexane	1.2	7.4
Hydrogen	4.0	75.0
Hydrogen Cyanide	5.6	40.0
Hydrogen Sulfide	4.0	44.0
Isobutane	1.8	8.4
Isobutylene	1.8	9.6
Isopropanol	2.2	-
Methane	5.0	15.0
Methanol	6.7	36.0
Methylacetylene	1.7	11.7
Methyl Bromide	10.0	15.0
3-Methyl-1-Butene	1.5	9.1
Methyl Cellosolve	2.5	20.0
Methyl Chloride	7.0	17.4
Methyl Ethyl Ketone	1.9	10.0

Gas	LEL	UEL
Methyl Mercaptan	3.9	21.8
Methyl Vinyl Ether	2.6	39.0
Monoethylamine	3.5	14.0
Monomethylamine	4.9	20.7
Nickel Carbonyl	2.0	-
Pentane	1.4	7.8
Picoline	1.4	-
Propane	2.1	9.5
Propylene	2.4	11.0
Propylene Oxide	2.8	37.0
Styrene	1.1	-
Tetrafluoroethylene	4.0	43.0
Tetrahydrofuran	2.0	-
Toluene	1.2	7.1
Trichloroethylene	12.0	40.0
Trimethylamine	2.0	12.0
Turpentine	0.7	-
Vinyl Acetate	2.6	-
Vinyl Bromide	9.0	14.0
Vinyl Chloride	4.0	22.0
Vinyl Fluoride	2.6	21.7
Xylene	1.1	6.6

# Fire Point

The *fire point* is the temperature to which the gas must be heated under the prescribed conditions of the test method to burn continuously when the mixture of vapor and air is ignited by a specified flame (ASTM D92).

From the viewpoint of safety, information about the flash point is of most significance at or slightly above the maximum temperatures (30 to 60°C, 86 to 140°F) that may be encountered in storage, transportation, and use

of liquid petroleum products, in either closed or open containers. In this temperature range the relative fire and explosion hazard can be estimated from the flash point. For products with flash point below 40 °C (104 °F) special precautions are necessary for safe handling. Flash points above 60 °C (140 °F) gradually lose their safety significance until they become indirect measures of some other quality.



# Fischer-Tropsch Chemistry

Fischer-Tropsch synthesis of hydrocarbons involves a vast number of reactions that can be summarized in the general form:

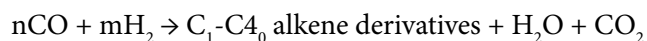
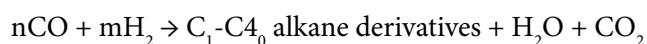

Alcohols or other oxygenates may also be formed but they are in very small amounts and are usually neglected. Whether the products of the process contain alkanes or alkenes depends primarily on: (1) the ratio of hydrogen to carbon monoxide, (2) the catalyst, (3) the type of reactor, and (4) the process parameters.

**Table** Reactions occurring during the Fischer-Tropsch Synthesis.

Main reactions	
1. Paraffins	$(2n + 1)\text{H}_2 + n\text{CO} \rightarrow \text{C}_n\text{H}_{2n+2} + n\text{H}_2\text{O}$
2. Olefins	$2n\text{H}_2 + n\text{CO} \rightarrow \text{C}_n\text{H}_{2n} + n\text{H}_2\text{O}$
3. Water gas shift reaction	$\text{CO} + \text{H}_2\text{O} \rightleftharpoons \text{CO}_2 + \text{H}_2$
Side reactions	
4. Alcohols	$2n\text{H}_2 + n\text{CO} \rightarrow \text{C}_n\text{H}_{2n+2}\text{O} + (n - 1)\text{H}_2\text{O}$
5. Boudouard reaction	$2\text{CO} \rightarrow \text{C} + \text{CO}_2$
Catalyst modifications	
6. Catalyst oxidation/reduction	a. $\text{M}_x\text{O}_y + y\text{H}_2 \rightleftharpoons y\text{H}_2\text{O} + x\text{M}$
	b. $\text{M}_x\text{O}_y + y\text{CO} \rightleftharpoons y\text{CO}_2 + x\text{M}$
7. Bulk carbide formation	$y\text{C} + x\text{M} \rightleftharpoons \text{M}_x\text{C}_y$



# Flammability and Flammability Limits

The *flash point* of a substance is the lowest temperature at which a flammable liquid gives off sufficient vapor to form an ignitable mixture with air near its surface or within a vessel. The *fire point* is the temperature at which the flame becomes self-sustained and the burning continues. At the flash point, the flame does not need to be sustained. The fire point is usually a few degrees above the flash point (ASTM D56, ASTM D92, ASTM D93, ASTM D1310, ASTM D3828). When several values are available, the lowest temperature is usually taken in order to assure safe operation of the process.

The *ignition temperature* (or *ignition point*) is the minimum temperature required to initiate self-sustained combustion of a substance (solid, liquid, or gaseous) and independent of external ignition sources or heat.

The upper and lower flammability limits (Table) are the boundary-line mixtures of vapor or gas with air, which, if ignited, will just propagate flame and are given in terms of percent by volume of gas or vapor in the air. Each of these limits also has a temperature at which the flammability limits are reached. The temperature corresponding to the lower-limit partial vapor pressure should equal the flash point. The temperature corresponding to the upper-limit partial vapor pressure is somewhat above the lower limit and is usually considerably below the auto-ignition temperature. Flammability limits are calculated at one atmosphere total pressure and are normally considered synonymous with explosive limits. Limits in oxygen rather than air are sometimes measured and available. Limits are generally reported at 298°K and 1 atmosphere. If the temperature or the pressure is increased, the lower limit will decrease while the upper limit will increase, giving a wider range of compositions over which flame will propagate.

The *auto-ignition temperature* is the minimum temperature for a substance to initiate self-combustion in air in the

absence of a spark or flame. The temperature is no lower than and is generally considerably higher than the temperature corresponding to the upper flammability limit. Large differences can occur in reported values determined by different procedures. The lowest reasonable value should be accepted in order to assure safety. Values are also sometimes given in oxygen rather than in air. One simple method of estimating auto-ignition temperatures is to compare values for a compound on a graphical representation of data for the other members of its homologous series vs. carbon number as the temperature decreases and carbon number increases.

The most preferred flash point prediction method uses the formula of the compound, the system pressure, and vapor pressure data:

$$P^{\text{sat}} = \frac{P}{1 + 4.76(2\beta - 1)} = 0$$
$$\beta = N_C + N_S + \frac{(N_H - N_X)}{4} - \frac{N_O}{2}$$

Ns are the numbers of atoms of carbon (C), sulfur (S), hydrogen (H), halogens (X), and oxygen (O) in the molecule. P is the total system pressure, and  $P^{\text{sat}}$  is the vapor pressure of the compound at the flash point temperature.

However, caution is advised when attempting to calculate and predict the flash point of a mixture. Attempts to calculate any of the above properties using mathematical formulas that rely upon averaging the flash point of the constituents of a mixture will be incorrect and have serious consequences since, for example, the flash point of a mixture is not the average of the flash points of the individual constituents but is the flash point of the most volatile constituent in the mixture. In such a situation, calculation of the average flash point based on the proportion of the constituents in the mixture will only lead to serious consequences in the form of an unexpected fire and explosion.

**Table** Flammability limits of selected hydrocarbons in air.

Compound	Limits of Flammability	
	Lower volume %	Upper volume %
Acetylene	2.50	80.00
n-Amylene	1.42	8.70
Benzene	1.40	7.10
n-Butane	1.86	8.41
iso-Butane	1.80	8.44
Butene-1	1.65	9.95
Butene-2	1.75	9.70
Cyclohexane	1.26	7.75
Cyclopropane	2.40	10.40
n-Decane	0.77	5.35
Ethane	3.00	12.50
Ethylene	2.75	28.60
n-Heptane	1.10	6.70
n-Hexane	1.18	7.40
Methane	5.00	15.00
n-Nonane	0.83	2.90
n-Octane	0.95	6.50
n-Pentane	1.40	7.80
iso-Pentane (2-Methylbutane)	1.32	7.60
Propane	2.12	9.35
Propylene	2.00	11.20
Toluene	1.27	6.75
o-Xylene	1.00	6.00
m-Xylene	1.10	7.00
p-Xylene	1.10	7.00



# Flash Point

The flash point is the temperature to which gas must be heated under specified conditions to give off sufficient vapor to form a mixture with air that can be ignited momentarily by a specified flame, dependent on the composition of the gas and the presence of other hydrocarbon constituents. Thus, the flash point is that minimum temperature at which there is a sufficient concentration of evaporated fuel in the air for combustion to propagate after an ignition source has been introduced. At this temperature the vapor may cease to burn when the source of ignition is removed. Every flammable liquid has a vapor pressure, which is a function of temperature. As the temperature increases, the vapor pressure increases. As the vapor pressure increases, the concentration of evaporated flammable liquid in the air increases. Hence, temperature determines the concentration of evaporated flammable liquid in the air under equilibrium conditions.

The fire point is the temperature at which the vapor continues to burn after being ignited, even when the source of ignition is removed. Neither of these parameters is related to the temperatures of the ignition source or of the burning liquid, which are much higher. The flash point is often used as one descriptive characteristic of liquid fuel, but it is also used to describe liquids that are not used intentionally as fuels.

There are two basic standard (ASTM) test methods for measurement of the flash point measurement: (1) the open cup methods and (2) the closed cup methods which produce the desired data). In the open cup method, the sample is contained in an open cup which is heated, and at intervals a flame is brought over the surface. The measured flash point will actually vary with the height of the flame above the liquid surface, and at sufficient height the measured flash point temperature will coincide with the fire point. Examples include Cleveland Open Cup and Pensky-Martens open cup. The main difference are that the former is heated from below, while the latter is heated from the sides as well as from below. In the closed cup method, the sample is sealed with a lid through which the ignition source can be introduced

periodically. The vapor above the liquid is assumed to be in reasonable equilibrium with the liquid. The closed cup method usually gives a lower value for the flash point and is a better approximation to the temperature at which the vapor pressure reaches the lower flammable limit (LFL).

As with other properties, the flash point of a mixture, such as natural gas, is the flash point of the most volatile hydrocarbon in the mixture and, thus, is dependent on the composition of the gas and the presence of other hydrocarbon constituents (Table, Figure). The flash point is also used to detect contamination. A substantially lower flash point than expected for a product is a reliable indicator that a product has become contaminated with a more volatile product. The flash point is also an aid in establishing the identity of a particular product.

A slightly higher temperature, the fire point, is defined as the temperature at which the vapor continues to burn after being ignited, even when the source of ignition is removed. Neither of these parameters is related to the temperatures of the ignition source or of the burning liquid, which are much higher. The flash point is often used as one descriptive characteristic of liquid fuel, but it is also used to describe liquids that are not used intentionally as fuels.

**Table** Examples of flash points.

Fuel	Flash point	Auto-ignition temperature
Ethanol	12.8 °C (55 °F)	365 °C (689 °F)
Gasoline	<-40 °C (-40 °F)	246 °C (475 °F)
Diesel fuel	>62 °C (143 °F)	210 °C (410 °F)
Jet fuel	>38 °C (100 °F)	210 °C (410 °F)
Kerosene)	>38–72 °C (100–162 °F)	220 °C (428 °F)
Canola oil	327 °C (620 °F)	
biodiesel	>130 °C (266 °F)	

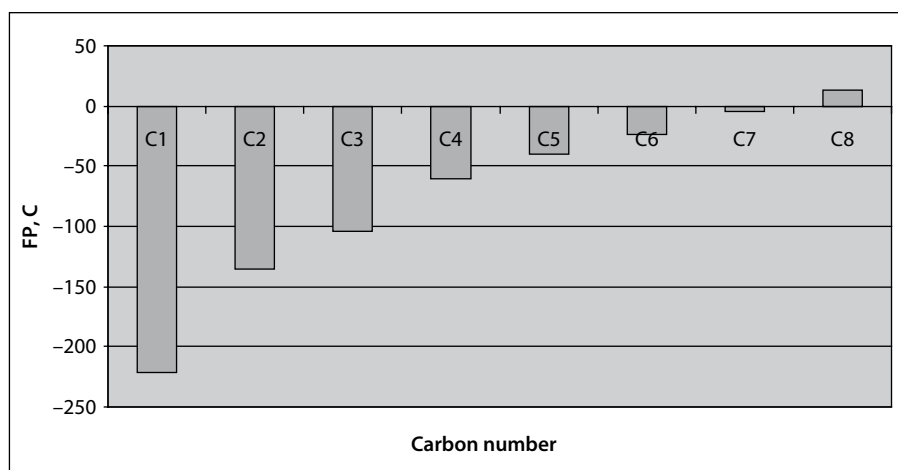

**Figure** Carbon number and flash point of natural gas hydrocarbons (up to octane,  $C_8H_{18}$ ).

# Flow Through Porous Media

The concept of flow through porous materials is well known in petroleum industry; oil production from a well is a perfect example of the principal. When oil is produced from a well, the oil first flows through the formation or the sandstone to the well. The formation is a porous matrix that allows fluid to pass through. For single fluid permeating through a vastly unbounded porous media, the governing equation remains the one first conceived by Darcy in 1856. Darcy's idea of flow through porous bed has been generalized to multiphase flow through porous media. The flow discharge velocity is proportional to the pressure drop with the proportionality constant being termed as permeability.

In an extension of Darcy's law to multiphase flows, the equation remains the same for each phase but allows the fluid properties as well as the permeability to differ. That is:

$$\mathbf{v}_i = -\frac{k_i}{\mu_i}(\nabla p_i - \rho_i \mathbf{g})$$

The subscript  $i$  denotes for the  $i^{\text{th}}$  fluid phase.

This equation lacks three key features: inertial effects; diffusion effects; and the inter-phase interactions. The lack of the first two features are inherited from the original Darcy's law. The last defect is simply due to the simplistic extension to multiphase flows. A large number of existing investigations deal with weak flows in soil and sandstones (for example, aquifers and reservoirs); negligence of the inertia and the diffusion effects does not normally pose any problems.

For multiphase flow, the flow of one phase can affect the motion of other phases. It may be expected that the interactions are linear when the inertia is negligible. For two-phase flows through porous media, the phase interactions may be added:

$$-(\nabla p_i - \rho_i \mathbf{g}) = \mu_i \left( \frac{\mathbf{v}_i}{k_i} - \frac{\mathbf{v}_j}{k_{ij}} \right)$$

$k_{ij}$  is the phase interaction coefficient.



# Fluid Catalytic Cracking – Chemistry

*Catalytic cracking* is the thermal decomposition of petroleum constituents in the presence of a catalyst. Thermal cracking has been superseded by catalytic cracking as the process for gasoline manufacture. Indeed, gasoline produced by catalytic cracking is richer in branched paraffins, cycloparaffins, and aromatics, which all serve to increase the quality of the gasoline. Catalytic cracking also results in production of the maximum amount of butene derivatives and butane derivatives ( $C_4H_8$  and  $C_4H_{10}$ ) rather than production of ethylene and ethane ( $C_2H_4$  and  $C_2H_6$ ).

Although thermal cracking is a free radical (neutral) process, catalytic cracking is an ionic process involving carbonium ions, which are hydrocarbon ions having a positive charge on a carbon atom. The formation of carbonium ions during catalytic cracking can occur by: (1) addition of a proton from an acid catalyst to an olefin and/or (2) abstraction of a hydride ion ( $H^-$ ) from a hydrocarbon by the acid catalyst or by another carbonium ion: However, carbonium ions are not formed by cleavage of a carbon-carbon bond. In essence, the use of a catalyst permits alternate routes for cracking reactions, usually by lowering the free energy of activation for the reaction. The acid catalysts first used in catalytic cracking were amorphous solids composed of approximately 87% silica ( $SiO_2$ ) and 13% alumina ( $Al_2O_3$ ) and were designated low-alumina catalysts. However, this type of catalyst is now being replaced by crystalline aluminosilicates (zeolites) or molecular sieves.

Coke formation is considered, with just cause, a malignant side reaction of normal carbenium ions. However, while chain reactions dominate events occurring on the surface, and produce the majority of products, certain less desirable bimolecular events have a finite chance of involving the same carbenium ions in a bimolecular interaction with one another. Of these reactions, most will produce a paraffin and leave carbene/carboid-type species on the surface. This carbene/carboid-type species can produce other products but the most damaging product will be one which remains on the catalyst surface and cannot be desorbed and results in the formation of coke, or remains in a non-coke form but effectively blocks the active sites of the catalyst.

A general reaction sequence for coke formation from paraffins involves oligomerization, cyclization, and dehydrogenation of small molecules at active sites within zeolite pores:

Alkanes  $\rightarrow$  alkenes  
Alkenes  $\rightarrow$  oligomers  
Oligomers  $\rightarrow$  naphthenes  
Naphthenes  $\rightarrow$  aromatics  
Aromatics  $\rightarrow$  coke

Whether or not these are the true steps to coke formation can only be surmised. The problem with this reaction sequence is that it ignores sequential reactions in favor of consecutive reactions. And it must be accepted that the chemistry leading up to coke formation is a complex process, consisting of many sequential and parallel reactions.

Table 1 Chemical reactions.

1.	Cracking:	
	Paraffins cracked to olefins and smaller paraffins	$C_{10}H_{22} \rightarrow C_4H_{10} + C_6H_{12}$
	Olefins cracked to smaller olefins	$C_9H_{18} \rightarrow C_4H_8 + C_5H_{10}$
	Aromatic side-chain scission	$ArC_{10}H_{21} \rightarrow ArC_5H_9 + C_5H_{12}$
	Naphthenes (cycloparaffins)cracked to olefins and smaller ring compounds	$Cyclo-C_{10}H_{20} \rightarrow C_6H_{12} + C_4H_8$
2.	Isomerization:	
	Olefin bond shift	$1-C_4H_8 \rightarrow trans-2-C_4H_8$
	Normal olefin to iso-olefin	$n-C_5H_{10} \rightarrow iso-C_5H_{10}$
	Normal paraffin to isoparaffin	$n-C_4H_{10} \rightarrow iso-C_4H_{10}$
	Cyclohexane to cyclopentane	$C_6H_{12} + C_5H_9CH_3$
3.	Hydrogen transfer:	Naphthene + olefin $\rightarrow$ aromatic + paraffin
	Cycloaromatization	$C_6H_{12} + 3C_5H_{10} \rightarrow C_6H_6 + 3C_5H_{12}$
4.	Transalkylation/alkyl-group transfer	$C_6H_4(CH_3)_2 + C_6H_6 \rightarrow 2C_6H_5CH_3$
5.	Cyclization of olefins to naphthenes	$C_7H_{14} \rightarrow CH_3-cyclo-C_6H_{11}$
6.	Dehydrogenation	$n-C_8H_{18} \rightarrow C_8H_{16} + H_2$
7.	Dealkylation	$Iso-C_3H_7-C_6H_5 \rightarrow C_6H_6 + C_3H_6$
8.	Condensation	$Ar-CH=CH_2 + R_1CH=CHR_2 \rightarrow Ar-Ar+2H$

Table 2 Thermodynamics.

Reaction class	Specific reaction	Log $K_E$ (Equilibrium constant)			Heat of reaction Btu/mole
		850 °F	950 °F	980 °F	950 °F
Cracking	$n-C_{10}H_{22} \rightarrow n-C_2H_{16} + C_3H_6$	2.04	2.46	-	32,050
	$1-C_8H_{16} \rightarrow 2C_4H_8$	1.68	2.10	2.23	33,663
Hydrogen transfer	$4C_6H_{12} \rightarrow 3C_6H_{14} + C_6H_6$	12.44	11.09	-	109,681
	$cyclo-C_6H_{12} + 3\ 1-C_5H_{10} \rightarrow 3n-C_5H_{12} + C_6H_6$	11.22	10.35	-	73,249
Isomerization	$1-C_4H_8 \rightarrow trans-2-C_4H_8$	0.32	0.25	0.09	-4,874
	$n-C_6H_{10} \rightarrow iso-C_4H_{10}$	-0.20	-0.23	-0.36	-3,420
	$o-C_6H_4(CH_3)_2 \rightarrow m-C_6H_4(CH_3)_2$	0.33	0.30	-	1,310
	$Cyclo-C_6H_{12} \rightarrow CH_3-cyclo-C_5H_9$	1.00	1.09	1.10	6,264
Transalkylation	$C_6H_6 + m-C_6H_4(CH_3)_2 \rightarrow 2C_6H_5CH_3$	0.65	0.65	0.65	-221
Cyclization	$1-C_2H_{14} \rightarrow CH_3-cyclo-C_6H_{11}$	2.11	1.54	-	-37,980
Dealkylation	$Iso-C_3H_7-C_6H_5 \rightarrow C_6H_6 + C_3H_6$	0.41	0.88	1.05	40,602
De hydrogenation	$n-C_6H_{14} \rightarrow 1-C_6H_{12} + H_2$	-2.21	-1.52	-	56,008
Polymerization	$3C_2H_4 \rightarrow 1-C_6H_{12}$	-	-	-1.2	-
Paraffin alkylation	$1-C_4H_8 + iso-C_4H_{10} \rightarrow iso-C_8H_{18}$	-	-	3.3	-

# Fluid Flow Fundamentals

Flow calculations focus essentially on two aspects of fluid flow: pressure profile along the flow path and the rate versus pressure relationship at key points of interest (nodes). The main parameters of interest (all in units of psia) are: (1)  $p_R$ , which is the reservoir pressure, (2)  $p_{wf}$ , which is the wellbore (bottomhole) flowing pressure, (3)  $p_{wh}$ , which is the wellhead pressure, (4)  $p_{sp}$ , which is the separator pressure, and (5)  $p_{ST}$ , which is the stock tank pressure. The corresponding rates are: (1)  $q_o$ , which is the oil production rate, STB/day, and  $q_g$ , which is the gas production rate, SCF/day. The pressure difference ( $p_R - p_{wf}$ ) (the *reservoir drawdown*) is the primary force driving reservoir fluids into the wellbore. Generally, production rates increase with increasing drawdown.

The relationship between the production flow rate measured at the stock tank,  $q_o$ , and the bottomhole flowing pressure,  $p_{wf}$  is the *inflow performance relationship, IPR*, which, for any well, can be determined directly by *production test* data, or it can be predicted from reservoir data. The IPR is a statement of the production capacity and is widely used to design and analyze the production performance of wells.

## Fluid Pressure Regimes

Fluid pressure regimes in hydrocarbon columns are dictated by the prevailing water pressure in the vicinity of the reservoir. In a perfectly normal case the water pressure at any depth can be calculated as:

$$p_w = (dp/dD)_{\text{water}} \times D + 4.7 \text{ (psia)}$$

in which  $dp/dD$ , the water pressure gradient, is dependent on the chemical composition (salinity), and for pure water has the value of 0.4335 psi/ft.

## Productivity Index Equation for Undersaturated Oil

The production rate in undersaturated oil wells is linearly proportional to the drawdown and the equation is:

$$q_o = J(p_R - p_{wf})$$

The characteristic constant relating the oil rate to the drawdown is called the productivity index,  $J$ , and is defined as:

$$J = \frac{q_o}{p_R - p_{wf}}$$

The units are STB/day/psi. The productivity index states the numbers of STB/day produced for every psi of pressure drawdown and thus reflects the productivity or deliverability of the well. When  $p_{wf}$  equals atmospheric pressure, the rate (*absolute open flow, AOF*, which is a useful indicator of well productivity) is often designated as  $q_{\text{max}}$ .

## Back Pressure Equations for Saturated Oil and Gas Wells

The equation for oil and gas wells is:

$$q_o = c(p_R^2 - p_{wf}^2)^n$$

This equation has two characteristic constants: the back pressure constant,  $c$ , and the back pressure exponent,  $n$ . The exponent  $n$  is a dimensionless number between 0.5 and 1.0. It approaches 1.0 for low rate wells and 0.5 for very high rate wells. Values of  $n$  and  $c$  can be determined graphically from a log-log plot of multiple rate test data in the form of ( $p_R^2 - p_{wf}^2$ ) versus  $q$  and the data point can be fitted to a straight line whose slope is  $1/n$ .

## Quadratic Equation for Saturated Oil and Gas Wells

For saturated oil and gas wells, the equation is:

$$(p_R^2 - p_{wf}^2) = Aq + Bq^2$$

The characteristic constants  $A$  and  $B$  are the corresponding slope and the intercept of the straight line obtained from

a Cartesian plot of the multiple rate test data in the following form:

$$\frac{(p_R^2 - p_{wf}^2)}{q} \text{ versus } (A + B_q)$$

#### *Extended Range Undersaturated Oil IPR*

For wells that operate and produce below bubble point pressure,  $p_b$  while the reservoir pressure is above the bubblepoint ( $p_{wf} > p_b$ ), the IPR can be represented by the following equations. Thus, when:

$$p_{wf} > p_b, \quad q_o = J(p_R - p_{wf})$$

Or when

$$p_{wf} < p_b, \quad q_o = J(p_R - p_b) + (J/2p_b)(p_b^2 - p_{wf}^2)$$

$$S_o = V_o/V_p \quad \text{and} \quad S_g = V_g/V_p$$

where  $S_o$  is the oil saturation expressed as a fraction,  $S_g$  is the gas saturation expressed as a fraction,  $V_o$  is the volume of oil in a given pore volume,  $V_g$  is the volume of gas in a given pore volume, and  $V_p$  is the pore volume.

The apparent or effective oil permeability,  $k_{eo}$  of one phase in the presence of a second phase can be arranged as the product of two terms: absolute permeability,  $k_a$ , and relative oil permeability,  $k_{ro}$ :

$$k_{eo} = k_a \times k_{ro}$$

The absolute permeability is a property of the rock and is essentially the permeability measured with single phase or at 100% single phase saturation. The relative permeability is a

dimensionless quantity with a magnitude between 1.0 and 0, depending on the saturation.

#### *Radial flow*

Darcy's law can be applied to an ideal well model producing a constant steady-state production rate. The model assumes cylindrical flow in the reservoir where flow across the formation is horizontal and fluid moves radially toward the wellbore. It also assumes constant pay zone thickness, constant isotropic permeability, and an ideal liquid (homogeneous incompressible liquid in which viscosity is pressure independent). Thus, for infinite size reservoirs:

$$p = p_{wf} + \frac{q\mu B}{2\pi kh} \ln(r/r_w)$$

In field units:

$$p = p_{wf} + \frac{141.2q_o\mu_o B_o}{kh} \ln(r/r_w)$$

Thus, for every radius  $r$  there is a corresponding pressure  $p$  that increases logarithmically with  $r$ .

#### *Radius of Drainage*

The radius of drainage to be used in the radial flow equation and the productivity index expression is:

$$r_e = (A/\pi)^{0.5}$$

In this equation,  $A$  is the drainage area (in square feet) of the well and the radius is in feet. If the drainage area is given in acres, it has to be converted to square feet using the relationship 1 acre = 43,560 ft<sup>2</sup>.



# Fluid Flow Through Permeable Media

## Productivity index

The productivity index,  $J$ , of an oil well is the ratio of the stabilized rate,  $q$ , to the pressure drawdown,  $(\bar{p} - p_{wf})$ , required to sustain that rate. For flow from a well centered in a circular drainage area, the productivity index can be related to formation and fluid properties:

$$J = \frac{q}{\bar{p} - p_{wf}} = \frac{kh}{141.2B\mu \left[ \ln \left( \frac{r_e}{r_w} \right) - \frac{3}{4} + s \right]}$$

The productivity index,  $J$ , can also be expressed for general drainage-area geometry as:

$$J = \frac{q}{\bar{p} - p_{wf}} = \frac{0.00708kh}{B\mu \left[ \frac{1}{2} \ln \left( \frac{10.06A}{C_A r_w^2} \right) - \frac{3}{4} + s \right]}$$

## Steady-State Flow

Pseudo-steady-state flow describes production from a closed drainage area (one with no-flow outer boundaries, either permanent and caused by zero-permeability rock or temporary and caused by production from offset wells). In pseudo-steady-state, reservoir pressure drops at the same rate with time at all points in the reservoir, including at the reservoir boundaries. Ideally, true steady-state flow can occur in the drainage area of a well, but only if pressure at the drainage boundaries of the well can be maintained constant while the well is producing at constant rate. While unlikely, steady-state flow is conceivable for wells with edge water drive or in repeated flood patterns in a reservoir. The solution to the radial diffusivity equation is based on a constant-pressure

outer boundary condition, instead of a no-flow outer boundary condition. The steady-state solution, applicable after boundary effects have been felt, is

$$p_i - p_{wf} = 141.2 \frac{qB\mu}{kh} \left[ \ln \left( \frac{r_e}{r_w} \right) + s \right]$$

## Linear Flow

Linear flow occurs in some reservoirs with long, highly conductive vertical fractures; in relatively long, relatively narrow reservoirs (channels, such as ancient stream beds); and near horizontal wells during certain times. For unsteady-state linear flow in an unbounded (infinite-acting) reservoir:

$$p_{wf} = p_i - 16.26 \frac{qB\mu}{kA} \left( \frac{kt}{\phi\mu c_t} \right)^{\frac{1}{2}} - 70.6 \frac{qB\mu}{kh} s_f$$

## Spherical Flow

Spherical flow occurs in wells with limited perforated intervals and into wireline formation test tools. The solution to the spherical/cylindrical, 1D form of the diffusivity equation, subject to the initial condition that pressure is uniform before production and the boundary conditions of constant flow rate and an infinitely large drainage area, is<sup>[5]</sup>

$$p_{wf} = p_i - \frac{70.6qB\mu}{k_s r_s} + \frac{2456\sqrt{\phi\mu c_t} qB\mu}{k_{sp}^{3/2}} \frac{1}{\sqrt{t}} - \frac{70.6qB\mu}{k_{sp} r_{sp}} s,$$

where  $k_{sp} = (k_r k_z^{1/2})^{2/3}$

and  $r_{sp}$  = the radius of the sphere into which flow converges.

## Symbols

$a$	$= \frac{1.422 \times 10^6}{k_g h} \left[ 1.151 \log \left( \frac{10.06A}{C_A r_w^2} \right) - \frac{3}{4} + s \right]$ , stabilized deliverability coefficient, psia <sup>2</sup> -cp/MMscf-D
$a$	= total length of reservoir perpendicular to wellbore, feet
$a_h$	= length of reservoir perpendicular to horizontal well, feet
$a_f$	$= \sqrt{L_f^2 + b_f^2}$ , depth of investigation along major axis in fractured well, feet
$a_t$	$= \sqrt{L_f^2 + b_f^2}$ , transient deliverability coefficient, psia <sup>2</sup> -cp/MMscf-D
$a_H$	= total width of reservoir perpendicular to the wellbore, feet
$a_H'$	= modified total width of reservoir perpendicular to the wellbore, feet
$A$	= drainage area, sq feet
$A$	$= \pi a b_f$ , area of investigation in fractured well, feet <sup>2</sup>
$A_f$	= cross-sectional area perpendicular to flow, sq feet
$A_{wb}$	= wellbore area, sq feet
$b$	$= \frac{1.422 \times 10^6 TD}{k_g h}$ (gas flow equation)
$b_f$	$= 0.02878 \left[ \frac{kt}{\phi \mu c_t} \right]^{1/2}$ depth of investigation of along minor axis in fractured well, feet
$b_B$	= intercept of Cartesian plot of bilinear flow data, psi
$b_H$	= length in direction parallel to wellbore, feet
$b_H'$	= modified length in direction parallel to wellbore, feet
$b_L$	= intercept of Cartesian plot of linear flow data, psi
$b_V$	= intercept of Cartesian plot of data during volumetric behavior, psi
$B$	= formation volume factor, reservoir volume/surface volume
$B_g$	= gas formation volume factor, RB/STB
$B_{gi}$	= gas formation volume factor evaluated at $p_i$ , RB/Mscf
$B_o$	= oil formation volume factor, RB/Mscf
$B_w$	= water formation volume factor, RB/STB
$\bar{B}_g$	= gas formation volume factor evaluated at average drainage area pressure, RB/Mscf
$B_{ND}$	= $1,422 \mu z TD/kh$ , non-Darcy flow coefficient
$c$	= compressibility, psi <sup>-1</sup>
$c_f$	= formation compressibility, psi <sup>-1</sup>
$c_g$	= gas compressibility, psi <sup>-1</sup>
$c_o$	= oil compressibility, psi <sup>-1</sup>
$c_t$	$= S_o c_o + S_w c_w + S_g c_g + c_f$ = total compressibility, psi <sup>-1</sup>
$c_w$	= water compressibility, psi <sup>-1</sup>
$\bar{c}_t$	= total compressibility evaluated at average drainage area pressure, psi <sup>-1</sup>
$c_{if}$	= total compressibility of pore space and fluids in fracture porosity, psi <sup>-1</sup>
$c_{im}$	= total compressibility of pore space and fluids in matrix porosity, psi <sup>-1</sup>
$c_{wb}$	= compressibility of fluid in wellbore, psi <sup>-1</sup>
$C$	= performance coefficient in gas-well deliverability equation, or wellbore storage coefficient, bbl/psi
$C_A$	= shape factor or constant
$C_D$	$= 0.8936 C / \phi c_t h r_w^2$ , dimensionless wellbore storage coefficient
$(C_D e^{2s})_f$	= type-curve parameter value for the formation
$(C_D e^{2s})_{f+m}$	= type-curve parameter value for the formation plus the matrix
$C_{Lfd}$	$= 0.8936 C / \phi c_t h L_f^2$ dimensionless wellbore storage coefficient in fractured well
$C_r$	$= w k_f / \pi k L_p$ fracture conductivity, dimensionless

$d_x$	= shortest distance between horizontal well and $x$ boundary, feet
$d_y$	= shortest distance between tip of horizontal well and $y$ boundary, feet
$d_z$	= shortest distance between horizontal well and $z$ boundary, feet
$D_x$	= longest distance between horizontal well and $x$ boundary, feet
$D_y$	= longest distance between tip of horizontal well and $y$ boundary, feet
$D_z$	= longest distance between horizontal well and $z$ boundary, feet
$D$	= non-Darcy flow constant, D/Mscf
$e^{-bt}$	= exponential decline with a constant $b$ and elapsed time, $t$
$E_f$	= flow efficiency, dimensionless
$Ei(-x)$	= $\int_x^\infty (e^{-u} - 1/u) du$ , the exponential integral
$F(u)$	= function used in horizontal well analysis
$F_{CD}$	= $w_f k_f / k L_p$ , fracture conductivity, dimensionless
$g$	= acceleration due to gravity, feet/sec <sup>2</sup>
$g_c$	= gravitational units conversion factor, 32.17 (lbm/foot)(lbf-s <sup>2</sup> )
$h$	= net formation thickness, feet
$h_D$	= $(h/r_w)(k_h/k_v)^{1/2}$ , dimensionless
$h_f$	= fracture height, feet
$h_m$	= thickness of matrix, feet
$h_p$	= perforated interval thickness, feet
$h_{pD}$	= $h_p/h_t$
$h_t$	= total formation thickness, feet
$h_1$	= distance from top of formation to top of perforations, feet
$h_{1D}$	= $h_1/h_t$
$HTR_{avg}$	= HTR at average drainage area pressure
$J$	= productivity index, STB/D, psi
$J_{actual}$	= actual well productivity index, STB/D-psi
$J_{ideal}$	= ideal productivity index ( $s = 0$ ), STB/D-psi
$k$	= matrix permeability, md
$\bar{k}$	= average permeability, md
$k_f$	= permeability of the proppant in the fracture, md
$k_{fs}$	= permeability near the wellbore, md
$k_g$	= permeability to gas, md
$k_{gp}$	= permeability of the gravel in the gravel pack, md
$k_h$	= horizontal permeability, md
$k_m$	= matrix permeability, md
$k_o$	= permeability to oil, md
$k_r$	= permeability in horizontal radial direction, md
$k_s$	= permeability of altered zone, md
$k_w$	= permeability to water, md
$k_x$	= permeability in $x$ -direction, md
$k_y$	= permeability in $y$ -direction, md
$k_z$	= permeability in $z$ -direction, md
$L$	= distance from well to no-flow boundary, feet
$L_d$	= drilled length of horizontal well, feet
$L_f$	= fracture half length, feet
$L_g$	= length of flow path through gravel pack, feet
$L_m$	= length of matrix, feet

- $L_p$  = length of perforation tunnel, feet  
 $L_s$  = length of damaged zone in fracture, feet  
 $L_w$  = completed length of horizontal well, feet  
 $L_x$  = distance from boundary, feet  
 $m$  =  $162.2 qB\mu/kh$  = slope of middle-time line, psi/cycle  
 $m_B$  = slope of bilinear flow graph, psi/hr<sup>1/4</sup>  
 $m_L$  = slope of linear flow graph, psi/hr<sup>1/2</sup>  
 $m_s$  =  $2456 \frac{\sqrt{\phi\mu c_t qB\mu}}{k_{sp}^{3/2}}$ , slope of spherical flow plot, psi-hr<sup>1/2</sup>  
 $m_V$  = slope of volumetric flow graph, psi/hr  
 $m_{hrf}$  = slope of semilog plot for hemiradial flow, psi/log cycle  
 $m_{elf}$  = slope of square-root-of-time plot for early linear flow, psi/ $\sqrt{hr}$   
 $m_{erf}$  = slope of semilog plot of early radial flow, psi/log cycle  
 $m_{llf}$  = slope of square-root-of-time plot for late linear flow, psi/ $\sqrt{hr}$   
 $m_{prf}$  = slope of semilog plot for pseudoradial flow, psi/log cycle  
 $M$  = Molecular weight of gas  
 $MTR$  = middle-time region  
 $n$  = inverse slope of the line on a log-log plot of the change in pressure squared or pseudo pressure vs. gas flow rate  
 $p$  = pressure, psi  
 $p_{avg}$  = average pressure, psi  
 $p_b$  = base (atmospheric) pressure, psia  
 $p_0$  = arbitrary reference or base pressure, psi  
 $\bar{p}$  = volumetric average or static drainage-area pressure, psi  
 $p_a$  = adjusted or normalized pseudo pressure,  $(\mu z/p)p_p$ , psia  
 $p_{awf}$  = adjusted flowing bottomhole pressure, psia  
 $p_{aws}$  = adjusted shut-in bottomhole pressure, psia  
 $p_f$  = formation pressure, psi  
 $p_i$  = original reservoir pressure, psi  
 $p_m$  = matrix pressure, psi  
 $p_p$  = pseudopressure, psia<sup>2</sup>/cp  
 $p_s$  = stabilized shut-in BHP measured just before start of a deliverability test, psia  
 $p_{sc}$  = standard-condition pressure, psia  
 $p_t$  = surface pressure in tubing, psi  
 $p_w$  = BHP in wellbore, psi  
 $p_{wf}$  = flowing BHP, psi  
 $p_{ws}$  = shut-in BHP, psi  
 $p_{xy}$  = parameter in horizontal well analysis equations  
 $p_{xyz}$  = parameter in horizontal well analysis equations  
 $p_y$  = parameter in horizontal well analysis equations  
 $p_{1hr}$  = pressure at 1-hour shut-in (flow) time on MTR line or its extrapolation, psi  
 $p'$  = pressure derivative  
 $p^*$  = MTR pressure trend extrapolated to infinite shut-in time, psi  
 $p_D$  =  $0.00708 kh(p_i - p)/qB\mu$ , dimensionless pressure as defined for constant-rate production  
 $p_{MBHD}$  = Matthews-Brons-Hazebroek pressure, dimensionless  
 $(p_D)_{MP}$  = dimensionless pressure at match point  
 $q$  = flow rate at surface, STB/D  
 $q_{AOF}$  = absolute-open-flow potential, MMscf/D

$q_g$	= gas flow rate, Mscf/D
$q_o$	= water flow rate, STB/D
$q_{Rt}$	= total flow rate at reservoir conditions, RB/D
$q_{sf}$	= flow rate at formation (sand) face, STB/D
$q_w$	= water flow rate, STB/D
$r$	= distance from the center of wellbore, feet
$r_a$	= radius of altered zone (skin effect), feet
$r_d$	= effective drainage radius, feet
$r_{dp}$	= radius of damage zone around perforation tunnel, feet
$r_e$	= external drainage radius, feet
$r_i$	= radius of investigation, feet
$r_p$	= radius of perforation tunnel, feet
$r_s$	= outer radius of the altered zone, feet
$r_{sp}$	= radius of source or inner boundary of spherical flow pattern, feet
$r_w$	= wellbore radius, feet
$r_{wa}$	= apparent or effective wellbore radius, feet
$r_D$	= $r/r_w$ , dimensionless radius
$R_s$	= dissolved GOR, scf/STB
$s$	= skin factor, dimensionless
$s_a$	= skin caused by alteration of permeability around wellbore, dimensionless
$s_c$	= convergence skin, dimensionless
$s_d$	= skin caused by formation damage, dimensionless
$s_e$	= skin caused by eccentric effects, dimensionless
$s_{dp}$	= perforation damage skin, dimensionless
$s_f$	= skin of hydraulically fractured well, dimensionless
$s_{gp}$	= skin factor from to Darcy flow through gravel pack, dimensionless
$s_{min}$	= minimum skin factor, dimensionless
$s_p$	= skin resulting from an incompletely perforated interval, dimensionless
$s_t$	= total skin, dimensionless
$s_\theta$	= skin factor resulting from well inclination, dimensionless
$s'$	= $s + Dq$ = apparent skin factor, dimensionless
$S_g$	= gas saturation, fraction of pore volume
$S_o$	= oil saturation, fraction of pore volume
$S_w$	= water saturation, fraction of pore volume
$t$	= elapsed time, hours
$t_a$	= $\mu c_t t_{ap}$ , adjusted or normalized pseudo time, hours
$t_{ap}$	= pseudo time, hours
$t_{bD}$	= dimensionless time in linear flow, hours
$t_D$	= $0.0002637 kt / \phi \mu c_t r_w^2$ , dimensionless time
$t_{DA}$	= $0.0002637 kt / \phi \mu c_t A$ = dimensionless time based on drainage area, A
$t_{eqB}$	= equivalent time for bilinear flow, hours
$t_e$	= equivalent time, hours
$t_{LFD}$	= $0.0002637 kt / \phi \mu e L_f^2$ , dimensionless time for fractured wells
$t_p$	= pseudo producing time, hours
$t_{pD}$	= pseudo producing time, dimensionless
$t_{prf}$	= time required to reach the pseudoradial flow regime, hours
$t_{Eelf}$	= end of early linear flow, t, hours

$t_{\text{Eerf}}$	= end of early radial flow, t, hours
$t_{\text{Elf}}$	= end of linear flow, hours
$t_{\text{Ellf}}$	= time to end of late linear flow regime, hours
$t_{\text{Ehrf}}$	= end of hemiradial flow, hours
$t_{\text{Erf}}$	= end of early radial flow, hours
$t_{\text{Eprf}}$	= end of pseudoradial flow, hours
$t_p$	= constant-rate production period, t, hours
$t_{pAD}$	= dimensionless producing time, hours
$t_{pss}$	= time required to reach pseudo steady state, hours
$t_{\text{Self}}$	= start of early linear flow, hours
$t_{\text{Sllf}}$	= start of late linear flow, hours
$t_{\text{Shrf}}$	= start of hemiradial flow, t, hours
$t_{\text{Sprf}}$	= start of pseudoradial flow, t, hours
$t_s$	= time required for stabilization, hours
$T$	= reservoir temperature, °R
$T_{sc}$	= standard condition temperature, °R
$u$	= dummy variable
$V$	= volume, bbl
$V_f$	= fraction of bulk volume occupied by fractures
$V_m$	= fraction of bulk volume occupied by matrix
$V_w$	= $V_{wb}$ = wellbore volume, bbl
$w$	= width of channel reservoir, feet
$w_f$	= fracture width, feet
$wk_f$	= fracture conductivity, md-feet
$w_s$	= width of damaged zone around fracture face,
WBS	= wellbore storage
$z$	= gas-law deviation factor, dimensionless
$\bar{z}$	= gas-law deviation factor at average reservoir pressure, dimensionless
$\Delta p$	= pressure change since start of transient test, psi
$(\Delta p)_{\text{MP}}$	= pressure change at match point
$\Delta p_D$	= dimensionless pressure change
$\Delta p_p$	= pseudopressure change since start of test, psia <sup>2</sup> /cp
$\Delta p_s$	= additional pressure drop due to skin, psi
$\Delta p_{t=0}$	= pressure drop at time zero, psi
$\Delta p_{1\text{hr}}$	= pressure change from start of test to one hour elapsed time, psi
$\Delta t$	= time elapsed since start of test, hours
$\Delta t_a$	= $\bar{\mu} \bar{c}_i \Delta t_{ap}$ , normalized or adjusted pseudo time, hours
$\Delta t_{ap}$	= $\int_0^{\Delta t} \frac{dt}{\mu(p)c_t(p)}$ , pseudo time, hr-psia/cp
$\Delta t_{Be}$	= bilinear equivalent time, hours
$\Delta t_e$	= radial equivalent time, hours
$\Delta t_{Le}$	= linear equivalent time, hours
$\Delta t_{\text{max}}$	= maximum shut-in time in pressure buildup test, hours
$\Delta V$	= change in volume, bbl
$\eta$	= $0.0002637 k/\phi\mu c_p$ , hydraulic diffusivity, feet <sup>2</sup> /hr
$\eta_{fD}$	= hydraulic diffusivity, dimensionless

$\lambda$	= interporosity flow coefficient
$\lambda_t$	= $\frac{k_0}{\mu_0} + \frac{k_w}{\mu_w} + \frac{k_g}{\mu_g}$ , total mobility, md/cp
$\alpha$	= exponent in deliverability equation
$\alpha$	= parameter characteristic of system geometry in dual-porosity system
$\beta$	= turbulence factor
$\beta'$	= transition parameter
$\gamma$	= Euler's constant, = 1.781, dimensionless
$\gamma_g$	= gas gravity (air = 1.0)
$\gamma_m$	= matrix density
$\omega$	= storativity ratio in dual porosity reservoir
$\mu$	= viscosity, cp
$\mu_i$	= viscosity evaluated at $p_i$ , cp
$\mu_g$	= gas viscosity, cp
$\mu_o$	= oil viscosity, cp
$\mu_w$	= water viscosity, cp
$\bar{\mu}_g$	= gas viscosity evaluated at average pressure, cp
$\mu_{gwf}$	= gas viscosity evaluated at $p_{wf}$ , cp
$\bar{\mu}$	= viscosity evaluated at $\bar{p}$ , cp
$\rho$	= density, lbm/feet <sup>3</sup> or g/cm <sup>3</sup>
$\rho_{wb}$	= density of liquid in wellbore, lbm/feet <sup>3</sup>
$\phi_f$	= fraction of fracture volume occupied by pore space, $\cong 1$
$\phi_m$	= fraction of matrix volume occupied by pore space
$(\phi V)_f$	= fraction of bulk volume occupied by pore space in fractures
$(\phi Vc)_f$	= fracture "storativity" for dual porosity reservoir
$(\phi Vc)_{f+m}$	= total "storativity" for dual porosity reservoir
$(\phi V)_m$	= fraction of bulk volume occupied by pore space in matrix
$\phi$	= porosity, dimensionless
$\Sigma s$	= sum of damage skin, turbulence, and other pseudo skin factors





# Fluid Flow

For fluids that are sufficiently dense to be a continuum, do not contain ionized species, and have flow velocities small in relation to the speed of light, the momentum equations for Newtonian fluids are the Navier-Stokes equations, which is a nonlinear set of differential equations that describe the flow of a fluid whose stress depends linearly on flow velocity gradients and pressure.

In addition to the mass, momentum, and energy conservation equations, a thermodynamic equation of state giving the pressure as a function of other thermodynamic variables for the fluid is required to completely specify the problem. An example of this would be the typical gas equation of state:

$$p = (\rho R_u T) / M$$

$p$  is the pressure,  $\rho$  is the density,  $R_u$  is the gas constant,  $M$  is the molar mass, and  $T$  is the temperature.

## Fluid Flow Velocity

$$V = 1497 D^2 (p_1 - p_2) / \mu L$$

where

$D$  = pipe inside diameter, in

$L$  = pipe length, ft

$p$  = pressure, psig

$V$  = fluid velocity, ft/sec

$\mu$  = fluid absolute viscosity, cP

$$V = 0.3208 Q / A$$

where

$A$  = area of pipe, in<sup>2</sup>

$Q$  = fluid flow, gal/min

$V$  = fluid velocity, ft/sec

$$V = 0.408 Q / D^2$$

where

$D$  = pipe inside diameter, in

$Q$  = fluid flow, gal/min

$V$  = fluid velocity, ft/sec

$$V_1 = 8 h_s^{1/2}$$

$$V_2 = 12.2 p^{1/2}$$

where

$h_s$  = head, static pressure, ft (fluid)

$p$  = pressure, psig



# Fluid Saturation

Fluid saturation refers to the relative amount of fluid in the reservoir and the fluid saturation is a measure of the gross void space in a reservoir rock that is occupied by a fluid. In addition to hydrocarbons, the pores of the rock reservoir contain water. Therefore, knowledge of the porous volume is not sufficient to establish the amounts of oil and/or gas contained in the formations. To estimate these volumes, it is necessary to settle down which percentile of the porous volume is occupied by each fluid. These percentiles are named saturation.

The sum of all the fluids that are present in the porous media is equal to 1. There are two ways to measure the original saturation of fluids: direct and indirect approaches. The direct one involves fluids extraction of reservoir or the leaching of fluids from a reservoir rock sample. The indirect one relies on measurements of other properties, such as capillary pressure, and derivation of mathematical relationships between the measured properties and saturation. In addition to porosity and permeability, the saturation of fluids in formations can also be determined using information of well geophysical logs. In these logs some electronic and/or radioactive signs are sent to the rocky formation and the answers are recorded and analyzed.

In most oil bearing formations it is believed that the rock was completely saturated with water prior to the invasion and trapping of petroleum. The less dense hydrocarbons migrate to positions of hydrostatic and dynamic equilibrium, thus displacing water from the interstices of the structurally high part of the rock. The oil will not displace

all the water. Thus, reservoir rocks normally contain both petroleum hydrocarbons and water (frequently referred to as connate water) occupying the same or adjacent pores. To determine the quantity of hydrocarbons accumulated in a porous rock formation, it is necessary to determine the fluid saturation (oil, water, and gas) of the rock material.

In a reservoir, there is always more than one fluid phase occupying the pore space. In an oil reservoir, oil and water occupy the pore space. In a gas reservoir, gas and water occupy the pore space. At a certain point in the production of an oil reservoir, oil, water and gas could occupy the pore space. There is a need to keep track of the quantity of each type of fluid occupying the pore space. Fluid saturation is the petrophysical property that describes the amount of each fluid type in the pore space. It is defined as the fraction of the pore space occupied by a fluid phase. In general,

$$\text{Fluid Saturation} = (\text{Fluid volume}) / (\text{effective rock pore volume})$$

All saturation values are based on pore volume and not on the gross reservoir volume. The saturation of each individual phase ranges between zero to 100%. By definition, the sum of the saturations is 100%, therefore:

$$S_g + S_o + S_w = 1.0$$

$S_g$  = volume of gas/pore volume,  $S_o$  = volume of oil/pore volume,  $S_w$  = volume of water/pore volume.



# Foamy Oil

Foamy oil is oil-continuous foam that contains dispersed gas bubbles produced at the wellhead from heavy oil reservoirs under solution gas drive. The nature of the gas dispersions in oil distinguishes foamy oil behavior from conventional heavy oil. The gas that comes out of solution in the reservoir does not coalesce into large gas bubbles nor into a continuous flowing gas phase. Instead it remains as small bubbles entrained in the crude oil, keeping the effective oil viscosity low while providing expansive energy that helps drive the oil toward the producing. Foamy oil accounts for unusually high production in heavy oil reservoirs under solution-gas drive.

Foamy oil is oil-continuous foam that contains dispersed gas bubbles produced at the wellhead from heavy oil reservoirs under solution gas drive. The nature of the gas dispersions in oil distinguishes foamy oil behavior from conventional heavy oil. The gas that comes out of solution in the reservoir does not coalesce into large gas bubbles nor into a continuous flowing gas phase. Instead it remains as small bubbles entrained in the crude oil, keeping the effective oil viscosity low while providing expansive energy that helps drive the oil toward the producing. Foamy oil accounts for unusually high production in heavy oil reservoirs under solution-gas drive. It has also been observed that many heavy oil reservoirs in Alberta and Saskatchewan exhibit foamy oil behavior which is accompanied by sand production, leading to anomalously high oil recovery and lower gas oil ratio.

Foamy oil behavior (or specifically the solution gas mechanism of foamy oil) is mainly affected by what is commonly

termed as pseudo bubble point pressure. Conventional oil reservoirs have negligible critical supersaturation values. They release the dissolved gas immediately after reaching bubble pressure and it rapidly coalesces into large bubbles. Therefore, the bubble point of the conventional or non-foamy oils is the same as the true (thermodynamic) bubble pressure. For foamy oils, however, the critical supersaturation is considerable. The gas bubbles cannot immediately escape from the liquid phase and coalesce together to form large gas bubbles. The point at which the bubbles of free gas can finally start to escape from solution as a distinct free gas phase is known as the pseudo bubble point. The critical supersaturation, therefore, can be defined as the difference between the true bubble and pseudo bubble pressures.

Reservoirs that exhibit foamy oil behavior are typically characterized by the appearance of an oil-continuous foam at the wellhead. When oil is produced as this non-equilibrium mixture, reservoirs can perform with higher than expected rates of production: up to 30 times that predicted by Darcy's law, and lower than expected production gas-oil-ratios. Moreover, foamy oil flow is often accompanied by sand production along with the oil and gas – the presence of sand at the wellhead leads to sand dilation and the presence of high porosity, high permeability zones (wormholes) in the reservoir. It is generally believed that in the field, the high rates and recoveries observed are the combination of the foamy oil mechanism and the presence of these wormholes.



# Formation Volume Factor

The formation volume factor for oil ( $B_o$ ) is the volume in barrels that one stock tank barrel occupies in the formation at reservoir temperature and with the solution gas that is held in the oil at reservoir pressure. Due to the dramatically different conditions prevailing at the reservoir when compared to the conditions at the surface, we do not expect that 1 barrel of fluid at reservoir conditions could contain the same amount of matter as 1 barrel of fluid at surface conditions. Thus:

$$B_o = (V_o)_{p,T} / (V_o)_{SC}$$

In this equation,  $B_o$  is the oil formation volume factor in bbl/STB,  $(V_o)_{p,T}$  is the volume of oil (bbls) under reservoir pressure ( $p$ ) and temperature ( $T$ ), and  $(V_o)_{SC}$  is the volume of oil (bbls) measure under standard conditions (STB).

Values typically range from approximately 1.0 bbl/STB for crude oil systems containing little or no solution gas to nearly 3.0 bbl/STB for highly volatile oils. For saturated systems, gas is liberated as pressure is reduced below the bubblepoint, which results in a shrinkage in oil volume.

These correlations determine FVF based on the following function.

Volumetric factors were introduced in petroleum and natural gas calculations in order to readily relate the *volume* of fluids that are obtained at the surface (stock tank) to the volume that the fluid actually occupied when it was compressed in the reservoir. For example, the volume that a *live oil* occupies at the reservoir is *more* than the volume of oil that leaves the stock tank at the surface. This may be counter-intuitive. However, this is a result of the evolution of gas from oil as pressure decreases from reservoir pressure to surface pressure. If an oil had no gas in solution (i.e., a *dead oil*), the volume that it would occupy at reservoir conditions is less than the volume that it occupies at the surface. In this case, only liquid compressibility plays a role in the change of volume. Generally:

*Dead oil* (no dissolved gas):  $B_o =$  approximately 1.0

*Gassy* (deep) oil:  $B_o =$  approximately 1.4

*Typical* (shallow) oil:  $B_o =$  approximately 1.2





# Fouling

*Fouling* as it pertains to petroleum is deposit formation, encrustation, deposition, scaling, scale formation, slugging, and sludge formation, which has an adverse effect on recovery, transportation, and refining operations (Tables 1 and 2). It is the accumulation of unwanted material within a processing unit or on the solid surfaces of the unit to the detriment of function. For example, when it does occur during refinery operations, the major effects include (1) loss of heat transfer as indicated by charge outlet temperature decrease and pressure drop increase, (2) blocked process pipes, (3) under-deposit corrosion and pollution, (4) localized hot spots in reactors, all of which culminate in production losses and increased maintenance costs.

*Precipitation fouling* frequently involves separation of asphaltene-type material, coke precursors in thermal and catalytic processes or calcium salts. Through changes in temperature, or solvent evaporation or degasification, the concentration of such solids may exceed the saturation threshold, such as when an excess of paraffin derivatives are produced, leading to precipitation (or separation) of solids (Figure). In general, the dependence of the foulant solubility on temperature or presence of evaporation will often be the driving force for precipitation fouling. Precipitation fouling can also occur in the absence of heating or vaporization and can lead to precipitation fouling of reservoirs and wells in oil fields, decreasing their productivity with time. Similarly, precipitation fouling can occur because of solubility changes induced by other factors, e.g., liquid flashing, liquid degassing, redox potential changes, or mixing of incompatible fluid streams.

Fouling by particles suspended in a liquid or in a gas progresses by a mechanism different to the mechanism of precipitation fouling. This process is usually most important for colloidal particles, i.e., particles smaller than approximately 1  $\mu\text{m}$  in at least one dimension (but which are much larger than atomic dimensions). Particles are transported to the surface by a number of mechanisms and there they can

**Table 1** Natural gas and petroleum production/refining components\* subject to fouling.

Heat exchanger surfaces	Reduces thermal efficiency
	Decreases heat flux
	Increases temperature on the hot side
	Decreases temperature on the cold side
	Induces under-deposit corrosion
Injection/spray nozzles	Increases use of cooling water;
	Incorrect amount injected
	Malformed jet
	Component inefficiency
Piping, flow channels	Component failure
	Reduces flow,
	Increases pressure drop
	Increases upstream pressure
	Increases energy expenditure
	Can cause flow oscillations
	Causes slugging in two-phase flow
May induce vibrations	
Production zone	May cause flow blockage;
	Decreased production with time
	Plugging
Reverse osmosis membranes	Complete stoppage of flow
	Increases pressure drop
	Reduces flux
Venturi tubes	Membrane failure
	Inaccurate or incorrect measurement of flow rate

\*Listed alphabetically.

**Table 2** The Constituents of crude oils that can promote or cause fouling during recovery, transportation, and refining.

Property	Comment	Impact
API	Low API gravity	High potential for coke formation
		Carbon deposition on catalyst
		Catalyst fouling and deactivation
Sulfur	Requires hydrogen for removal as hydrogen sulfide	Corrosion
		Catalyst fouling and deactivation
Nitrogen	Requires hydrogen for removal as ammonia	Corrosion
		Catalyst fouling and deactivation
Metals Ni/V/Fe	Typically associated with asphaltene fraction	Catalyst fouling and deactivation
	Require guard bed catalysts	
Metals Na/Ca/Mg	Typically associated with high-acid crudes	Catalyst fouling and deactivation
	Require guard bed catalysts	Corrosion
		Catalyst fouling and deactivation
Coke precursors	Requires carbon rejection process	Catalyst fouling and deactivation
Asphaltene fraction	Increases potential for fouling	Phase separation during process
		Fouling
		Catalyst fouling and deactivation
Naphthenic acids	High levels cause corrosion	Corrosion and fouling
Compatibility	Certain crude blends are incompatible	Affects allowable blend behavior
		Phase separation
		Fouling
Chlorides	Typically associated with alkali metals	Corrosion
		Fouling
Viscosity	High viscosity	High potential for coke formation
		Phase separation during process
		Fouling

attach themselves, e.g., by flocculation or by coagulation. The attachment of colloidal particles typically involves electrical forces and thus the particle behavior defies the experience from the macroscopic world. The probability of attachment is sometimes referred to as the sticking probability:

$$k_d = Pk_t$$

$k_d$  and  $k_t$  are the kinetic rate constants for deposition and transport, respectively. The value of  $P$  for colloidal particles is a function of both the surface chemistry, geometry, and the local thermohydraulic conditions.

# Fracturing Fluids

Hydraulic fracturing is carried out using two broad classes of fracturing materials: fracturing fluid and proppants. The term *fracturing fluid* is a generic term that includes both the base fluid and additives (Table 1, Table 2). The additives are a wide range of chemicals (Table 3) that are used to influence the overall properties of the fracturing fluid. Since the default position of the fractures is the closed position, *propping agents (proppants)* are used to stop the fracture from closing after the fracture treatment to enable recovery of crude oil and natural gas – the most common proppant is fine sand.

In the process, the fracturing fluids are injected into the subsurface at a rate and pressure that are too high for the targeted formation to accommodate and, as the resistance to the injected fluids increases, the pressure in the injecting well increases to a level that exceeds the breakdown pressure of the rocks in the targeted formation. In this way, the hydraulic fracturing process fractures the targeted formation and, on occasion, other geologic strata within or around the targeted formation. This process sometimes does create new fractures, most often the process enlarges existing fractures thereby increasing the connections of the natural fracture networks in the targeted formation. The pressure-induced fracturing serves to connect the network of fractures in the formation to the hydraulic fracturing well (which subsequently will serve as the crude oil and/or natural gas production well). The fracturing fluids pumped into the subsurface under high pressure also deliver and emplace the proppant which, under pressure, is forced into the natural and/or enlarged fractures and acts to prop open the fractures even after the fracturing pressure is reduced. The increased permeability due to fracturing and proppant emplacement facilitates the flow and extraction of petroleum and gas from the fractured formation.

**Table 1** Different fluids used for hydraulic fracturing.

Fluid	Fluid type	Main composition
<b>Water-Based</b>	Slickwater	Water + sand (+ chemical additives)
Linear fluids		Gelled water
Cross-linked fluid		Cross-linking agent
Viscoelastic fluids		Electrolyte + surfactant
Surfactant gel fluids		
<b>Foam-Based</b>	Water-based foam	Water and Foamer + N <sub>2</sub> or CO <sub>2</sub>
Acid based foam		Acid and Foamer + N <sub>2</sub>
Alcohol based foam		Methanol and Foamer + N <sub>2</sub>
<b>Oil-Based</b>	Linear fluids	Oil, Gelled Oil
Cross-linked fluid		Phosphate Ester Gels
Water Emulsion		Water + Oil + Emulsifiers
<b>Acid-based</b>	Linear	
	Cross-linked	
	Oil emulsion	
<b>Alcohol-based</b>	Methanol/ water mixes or 100% methanol	Methanol + water
<b>Emulsion-based</b>	Water-oil emulsions	Water + Oil
CO <sub>2</sub> -methanol		CO <sub>2</sub> + water + methanol
<b>Other fluids</b>	Liquid CO <sub>2</sub>	CO <sub>2</sub>
Liquid nitrogen	N <sub>2</sub>	
Liquid helium	He	
Liquid natural gas	LPG (butane and/or propane)	

**Table 2** Fracturing fluid additives.

Type	Compound	Comment
Acid	Hydrochloric acid (also called <i>muriatic acid</i> )	For the fracturing of shale formations, acids are used to clean cement from casing perforations and drilling mud clogging natural formation porosity, if any prior to fracturing fluid injection (dilute acids concentrations are typically on the order of 15% v/v acid).
Biocide	Glutaraldehyde	Fracture fluids typically contain gels which are organic and can therefore provide a medium for bacterial growth. Bacteria can break down the gelling agent, reducing its viscosity and ability to carry proppant. Biocides are added to the mixing tanks with the gelling agents to kill these bacteria.
Breaker	Sodium Chloride	Chemicals that are typically introduced toward the later sequences of a fracturing project to break down the viscosity of the gelling agent to better release the proppant from the fluid as well as enhance the recovery or “flowback” of the fracturing fluid.
Corrosion inhibitor	N,N-dimethyl formamide	Used in fracture fluids that contain acids; inhibits the corrosion of steel tubing, well casings, tools, and tanks.
Cross-linking agent	Borate Salts	There are two basic types of gels that are used in fracturing fluids; linear and cross-linked gels. Cross-linked gels have the advantage of higher viscosities that do not break down quickly.
Friction Reducer	Petroleum distillate (also called <i>mineral oil</i> )	Minimizes friction allowing fracture fluids to be injected at optimum rates and pressures.
Gel	Guar gum (hydroxyethyl cellulose)	Gels are used in fracturing fluids to increase fluid viscosity allowing it to carry more proppant than a straight water solution. In general, gelling agents are biodegradable.

**Table 3** Examples of chemicals used in hydraulic fracturing fluids\*.

Chemical	Use
Acetic Acid	pH buffer
Acrylic copolymer	Lubricant
Ammonium persulfate	Breaker used to reduce viscosity
Boric Acid	Cross-linking agent to increase viscosity
Boric Oxide	Cross-linking agent to increase viscosity
2-Butoxyethanol	Reduction of surface tension to aid gas flow
Carbonic acid	Cross-linking agent to increase viscosity
Carboxy-Methyl Hydroxy-Propyl Guar	Gelling agent (thickens fluid)
Crystalline silica (cristobalite)	Proppant (holds open fractures)
Crystalline silica (quartz)	Proppant (holds open fractures)

Chemical	Use
Citric Acid	Iron control or for cleaning well bores
Diammonium Peroxidisulfate	Breaker used to reduce viscosity
Disodium Octaborate Tetrahydrate	Gelling agent/cross-linking agent to increase viscosity
Gas oils (petroleum), hydrotreated	Guar liquefier
Fumaric acid	pH buffer
Gelatin	Corrosion inhibitor or gelling agent
Guar Gum	Gelling agent
Hemicellulase Enzyme	Breaker used to reduce viscosity
Hydrochloric Acid	Cleaning of the wellbore prior to fracing
Hydroxy-Ethyl Cellulose	Gelling agent
Hydroxy-Propyl Guar	Gelling agent

Chemical	Use
Magnesium silicate hydrate	Gelling agent
Methanol	Gelling agent
Mono ethanol amine	Reduction of surface tension to aid gas flow
Ethylene Glycol Monobutyl Ether	Gelling agent
Muriatic Acid	Mutual solvent
Non-crystalline silica	Proppant
Poly (oxy-1,2-ethanediyl)	Proppant
Polydimethyldiallylammonium chloride	Clay control
Potassium Carbonate	pH buffer
Potassium Chloride	Clay inhibitor
1-Propanol	Complexing agent
Quaternary Polyamines	Clay control
Sodium acetate	pH buffer
Sodium borate	pH buffer
Sodium Bicarbonate	pH buffer

Chemical	Use
Sodium Carbonate (Soda Ash)	pH buffer
Sodium Chloride	Viscosity reducer
Sodium Hypochlorite	Bactericide
Sodium Persulfate	Viscosity reducer
Terpenes	Reduction of surface tension to aid gas flow
Tetramethyl ammonium chloride	Clay control
Zirconium complex	Cross-linking agent to increase viscosity

\*Listed alphabetically and not in order of preference; the fracturing fluid mix varies according to the nature of the task, and only a limited set of the above chemicals are used in any single project. The additives mentioned above are relatively-common components of a water-based fracturing solution used in tight shale formations. However, it is important to note that not all of the additives listed here are used in every hydrofracturing operation; the exact blend and proportions of additives will vary based on the site-specific depth, thickness and other characteristics of the target formation. More comprehensive lists of chemicals are available in the open literature.



# Fuel Oil

Fuel oil is classified in several ways but was formally divided into two main types: *distillate fuel oil* and *residual fuel oil*, each of which was a blend of two or more refinery streams. Distillate fuel oil is vaporized and condensed during a distillation process and thus has a definite boiling range and does not contain high-boiling constituents. A fuel oil that contains any amount of the residue from crude distillation of thermal cracking is a residual fuel oil. The terms *distillate fuel oil* and *residual fuel oil* are losing their significance, since fuel oil is now made for specific uses and may be either distillates or residuals or mixtures of the two. The terms *domestic fuel oil*, *diesel fuel oil*, and *heavy fuel oil* are more indicative of the uses of fuel oils.

Fuel oil may be categorized as either a distillate fuel or a residual fuel depending on the method of production. Fuel oil from biomass are not included, having been presented in detail elsewhere.

Fuel oil No. 1 and fuel oil No. 2 are distillate fuels which consist of distilled process streams. Residual fuel oil, such as fuel oil No. 4, is composed of the residuum remaining after distillation or cracking, or blends of such residues with distillates. Diesel fuel is approximately similar to fuel oil used for heating (fuel oil No. 1, fuel oil No. 2, and fuel oil No. 4).

All fuel oils consist of complex mixtures of aliphatic and aromatic hydrocarbons, the relative amounts depending on the source and grade of the fuel oil. The aliphatic alkanes (paraffins) and cycloalkane constituents (naphthene constituents) are hydrogen saturated and compose as much as 90% w/w of the fuel oil. Aromatic constituents (e.g., benzene) and olefin constituents compose up to 20% v/v and 1% v/v, respectively, of the fuel oils. Fuel oil No. 1 (straight run kerosene) is a distillate which consists primarily of hydrocarbons in the  $C_9$  to  $C_{16}$  range while fuel oil No. 2 is a higher-boiling, usually blended, distillate with hydrocarbons in the  $C_{11}$  to  $C_{20}$  range.

Diesel fuels predominantly contain a mixture of  $C_{10}$  to  $C_{19}$  hydrocarbons, which include aliphatic hydrocarbons (approximately 65% v/v), olefin hydrocarbons (up to 2% v/v), and aromatic hydrocarbons (up to 35% v/v). Jet fuels are based primarily on straight-run kerosene, as well as additives. All of the above fuel oils contain less than 5% v/v polycyclic aromatic hydrocarbons. Fuel No. 4 (also known as *marine diesel fuel*) is less volatile than diesel fuel No. 2 and may contain up to 15% v/v residual (high-boiling) streams, in addition to 5 to 10% v/v polycyclic aromatic hydrocarbon constituents.

Residual fuel oils are complex mixtures of high molecular weight compounds having a typical boiling range from 350 to 650 °C (660 to 1200 °F). They consist of aromatic, aliphatic and naphthenic hydrocarbons, typically having carbon numbers from  $C_{20}$  to  $C_{50}$ , together with asphaltene constituents and smaller amounts of heterocyclic compounds containing sulfur, nitrogen and oxygen. They have chemical characteristics similar to liquid asphalt and hence are considered to be stabilized suspensions of asphaltene constituents in an oily medium (API, 2004).

Residual fuel oil also contains organo-metallic compounds from their presence in the original crude oil – the most important of which are nickel and vanadium. The metals (especially vanadium) are of particularly major significance for fuels burned in both diesel engines and boilers because when combined with sodium (perhaps from brine contamination from the reservoir or remaining after the refinery dewatering/desalting process) and other metallic compounds in critical proportions can lead to the formation of high melting point ash, which is corrosive to engine parts. Other elements that occur in heavy fuel oils include iron, potassium, aluminum and silicon – the latter two metals are mainly derived from refinery catalyst fines.

**Table** Properties of the various fuel oils.

<b>Fuel oil</b>	<b>Properties</b>
No. 1 fuel oil	Similar to kerosene or range oil (fuel used in stoves for cooking).
	Defined as a distillate intended for vaporizing in pot-type burners and other burners where a clean flame is required.
No. 2 fuel oil	Often called <i>domestic heating oil</i> .
	Has properties similar to diesel and higher-boiling jet fuels. Defined as a distillate for general purpose heating in which the burners do not require the fuel to be completely vaporized before burning.
No. 4 fuel oil	A light industrial heating oil that is intended where preheating is not required for handling or burning.
	Two grades that differ primarily in safety (flash) and flow (viscosity) properties.
No. 5 fuel oil	A heavy industrial oil that often requires preheating for burning and, in cold climates, for handling.
No. 6 fuel oil	A heavy residuum oil.
	Commonly referred to as <i>Bunker C oil</i> when it is used to fuel ocean-going vessels.
	Preheating is required for both handling and burning this grade oil.



# Functional Groups

A functional group is the part of an organic molecule which contains atoms other than carbon and hydrogen, or which contain bonds other than a carbon-carbon single bond (C-C) and a carbon-hydrogen bond (C-H). Some of the most common functional groups in organic chemistry are: alkenes, alkynes, aromatics, nitriles, amines, amides, nitro compounds, alcohols, phenols, ethers, aldehydes, ketones, carboxylic acids, acid chlorides, acid anhydrides, esters, alkyl halides, thiols, and thioethers.

Thus, a functional group is any atom or collection of atoms that is capable of reacting with a reactive species to produce a product and is also capable of affecting the properties of the original non-functional molecule in which the group occurs. Some of the most common functional groups in organic chemicals are (1) the double bond of alkene derivatives ( $R_1C=CR_2$ ), (2) the triple bond of alkyne derivatives ( $R_1C\equiv CR_2$ ), (3) the aromatic ring in aromatic derivatives such as in benzene derivatives and including the ring systems in condensed-ring aromatic derivative), (4) the carbon-nitrogen function in nitrile derivatives ( $RC\equiv N$ ), (5) the carbon-nitrogen function in amine derivatives [ $RNH_2$ ,

$R_1NHR_2$ ,  $R_1NH(R_3)R_2$ ], (6) the oxygen-carbon-nitrogen function in amide derivatives ( $RCONH_2$ ), (7) the nitrogen-oxygen function in nitro compounds ( $RNO_2$ ), (8) the oxygen-hydrogen function in alcohol derivatives ( $ROH$ ), (9) the oxygen-hydrogen function in phenol derivatives ( $ArOH$ ), (10) the carbon-oxygen-carbon function in ether derivatives ( $R_1OR_2$ ), (11) the carbon-oxygen double bond in aldehyde derivatives ( $RCH=O$ ), (12) the carbon-oxygen double bond in ketone derivatives ( $R_1COR_2$ ), (13) the carbon-oxygen double bond and oxygen-hydrogen bond in carboxylic acid derivatives ( $RCO_2H$ ), (14) the carbon-oxygen double bond and oxygen-chloride bond in acid chloride derivatives ( $RCOCl$ ), (15) the carbon-oxygen-carbon bond in acid anhydride derivatives ( $R_1CO-O-COR_2$ ), (16) the carbon-oxygen-carbon bond in ester derivatives ( $R_1COOR_2$ ), the carbon-halogen bond in alkyl halide derivatives,  $RX$ , where  $X$  is a halogen, (17) the sulfur-hydrogen bond in thiol derivatives ( $RSH$ ), and (18) the carbon-sulfur-carbon bond in thioether derivatives  $R_1SR_2$ . In each of the aforementioned examples, case  $R_1$  and  $R_2$  are alkyl groups (the same or different) and  $Ar$  is a phenyl group or other aromatic group.

Table General Properties of Functional Group Compounds.

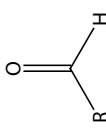
Group	Polarity	Volatility/Melting Point/Boiling Point	Soluble in Water	Acid-base Behavior	Common Compounds
Alkanes $C_nH_{2n+2}$	Non-polar	<ul style="list-style-type: none"> <li>Very volatile, smaller molecules are gases</li> <li>Boiling point increases with size due to increased dispersion forces and larger mass</li> </ul>	No	None	Methane, propane, butane, octane, and higher m.wt. hydrocarbons, including wax
Alkenes/Alkynes $C_nH_{2n}/C_nH_{2n-2}$	Non-polar	<ul style="list-style-type: none"> <li>Have similar b.p to alkanes w/ same # of carbons but a few degrees lower since they have fewer electrons = less dispersion forces</li> </ul>	No	None	
Halo-alkanes RX	Slightly Polar - non-polar	<ul style="list-style-type: none"> <li>Most halo-alkanes are liquids at room temperature</li> <li>Only <math>CH_3Cl</math>, <math>CH_3Br</math> and <math>CH_3CH_2Cl</math> are gasses</li> <li>Dispersion forces are more important than dipole-dipole forces</li> <li>B.P. decreases with # of substituents since temporary dipole is stronger for long chains and attractions are more effective when molecules can pack closely</li> </ul>	Slightly	None	Polyvinyl chloride Chlorofluorocarbons Teflon
Alcohols ROH	Polar bond capable of H-bonds	<ul style="list-style-type: none"> <li>Volatile when pure but often mixed w/ <math>H_2O</math></li> <li>Higher boiling points than alkanes b/c of hydrogen bonding</li> <li>Volatility and B.P increase as length of chain increases</li> </ul>	Yes, decreases w/ length of carbon chain	Weakly acidic and basic (amphoteric) like water b/c of -OH	Ethanol, isopropyl alcohol, menthol
Ethers ROR	Polar bonds, no H-bonds	<ul style="list-style-type: none"> <li>Volatile</li> <li>Lower boiling points than alcohols b/c no hydrogen bonding</li> </ul>			First anesthetic - diethyl ether
Amines $RNH_2$ or $R_2NH$ or $R_3N$	Polar bonds, capable of H-bonds	<ul style="list-style-type: none"> <li>Low volatility</li> <li>High boiling points b/c of H-bonding</li> </ul>	Yes	Basic b/c of lone pair, $R-NH_2$ even more basic than $NH_3$	Amino acids Ammonia
Aldehydes RCHO 	Polar carbonyl group (C=O) H-bond can form between carbonyl and water	<ul style="list-style-type: none"> <li>B.P. is higher than that of similarly sized alkanes b/c of dipole-dipole forces.</li> <li>B.P. is lower than alcohols since dipole-dipole forces are weaker than H-bonds.</li> <li>B.P. increase with size of carbon chain</li> </ul>	Yes, decreases w/ length of carbon chain	Carbonyl can act as a base	Formaldehyde

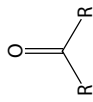
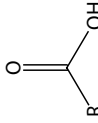
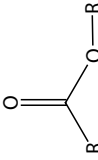
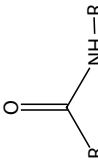
Ketones $\text{RCOR}$ 	Polar carbonyl group (C=O) H-bond can form between carbonyl and water	<ul style="list-style-type: none"> <li>• See aldehydes</li> </ul>	Yes, decreases w/ length of carbon chain	Carbonyl can act as a base	Acetone (nail polish remover)
Carboxylic Acids $\text{RCOOH}$ 	Polar, capable of hydrogen bonds	<ul style="list-style-type: none"> <li>• Low volatility</li> <li>• Higher boiling points b/c of hydrogen bonding</li> </ul>	Yes decreases w/ length of carbon chain	Acid Methanoic is stronger than ethanoic b/c of R group.	Acetic acid – vinegar
Esters $\text{RCOOR}$ 	Polar, no H-bonds H-bond can form between carbonyl and water	<ul style="list-style-type: none"> <li>• More volatility than carboxylic acids and lower boiling points b/c can't H-bond</li> <li>• Liquids at room temp for smaller molecules</li> </ul>	Small esters: yes, solubility decreases w/ size of chain		Polyesters Fatty acids
Amides 	Polar, amine can hydrogen bond	<ul style="list-style-type: none"> <li>• High m.p. b/c of hydrogen bonding</li> <li>• Amides are liquids or solids at room temp</li> </ul>	Yes	Amine part of amide is basic	Proteins Polypeptides Nylon



# Fundamental Physical Constants

Name	Value	Unit
absolute zero	-273.15	°C
acceleration of free fall	9.806 65	m s <sup>-2</sup>
atomic mass unit	1.660 538 782(83) × 10 <sup>-27</sup>	kg
Avogadro constant	6.022 141 79(30) × 10 <sup>23</sup>	mol <sup>-1</sup>
base of natural logarithms	2.718 281 828 459...	
Bohr magneton	927.400 915(23) × 10 <sup>-26</sup>	J T <sup>-1</sup>
Bohr radius	0.529 177 208 59(36) × 10 <sup>-10</sup>	m
Boltzmann constant	1.380 6504(24) × 10 <sup>-23</sup>	J K <sup>-1</sup>
characteristic impedance of vacuum	376.730 313 461...	Ω
classical electron radius	2.817 940 2894(58) × 10 <sup>-15</sup>	m
Dirac constant	1.054 571 628(53) × 10 <sup>-34</sup>	J s
electron mass	9.109 382 15(45) × 10 <sup>-31</sup>	kg
electron-proton mass ratio	5.446 170 2177(24) × 10 <sup>-4</sup>	
electronvolt	1.602 176 487(40) × 10 <sup>-19</sup>	J
elementary charge	1.602 176 487(40) × 10 <sup>-19</sup>	C
Euler's number	2.718 281 828 459...	
Faraday constant	96 485.3399(24)	C mol <sup>-1</sup>
Feigenbaum constant	4.669 201 609 102 990...	
Feigenbaum reduction parameter	2.502 907 875 095 892...	
fine-structure constant	7.297 352 5376(50) × 10 <sup>-3</sup>	
first radiation constant	3.741 771 18(19) × 10 <sup>-16</sup>	W m <sup>2</sup>
Hartree energy	4.359 743 94(22) × 10 <sup>-18</sup>	J
Josephson constant	483 597.891(12) × 10 <sup>9</sup>	Hz V <sup>-1</sup>
Loschmidt constant	2.686 7774(47) × 10 <sup>25</sup>	m <sup>-3</sup>
magnetic flux quantum	2.067 833 667(52) × 10 <sup>-15</sup>	Wb
molar gas constant	8.314 472(15)	J mol <sup>-1</sup> K <sup>-1</sup>
molar Planck constant	3.990 312 6821(57) × 10 <sup>-10</sup>	J s mol <sup>-1</sup>
molar volume (Ideal gas, T = 273.15 K, p = 101.325 kPa)	22.413 996(39) × 10 <sup>-3</sup>	m <sup>3</sup> mol <sup>-1</sup>
neutron mass	1.674 927 211(84) × 10 <sup>-27</sup>	kg

(Continued)

Name	Value	Unit
neutron-proton mass ratio	1.001 378 419 18(46)	
Newtonian constant of gravitation	$6.674\ 28(67) \times 10^{-11}$	$\text{m}^3 \text{kg}^{-1} \text{s}^{-2}$
nuclear magneton	$5.050\ 783\ 24(13) \times 10^{-27}$	$\text{J T}^{-1}$
permeability of vacuum	$12.566\ 370\ 614\dots \times 10^{-7}$	$\text{N A}^{-2}$
permittivity of vacuum	$8.854\ 187\ 817\dots \times 10^{-12}$	$\text{F m}^{-1}$
Pi	3.141 592 653 589 793 238...	
Planck constant	$6.626\ 068\ 96(33) \times 10^{-34}$	$\text{J s}$
proton mass	$1.672\ 621\ 637(83) \times 10^{-27}$	$\text{kg}$
reduced Planck constant	$1.054\ 571\ 628(53) \times 10^{-34}$	$\text{J s}$
Rydberg constant	10 973 731.568 527(73)	$\text{m}^{-1}$
second radiation constant	$1.438\ 7752(25) \times 10^{-2}$	$\text{m K}$
solar constant	1366	$\text{W m}^{-2}$
speed of light in vacuum	299 792 458	$\text{m s}^{-1}$
speed of sound in air	$331.5 + 0.6 * T/^{\circ}\text{C}$	$\text{m s}^{-1}$
standard pressure	101 325	$\text{Pa}$
Stefan-Boltzmann constant	$5.670\ 400(40) \times 10^{-8}$	$\text{W m}^{-2} \text{K}^{-4}$

## Gas Deviation Factor

A natural gas mixture under reservoir conditions is non-ideal and the behavior can be approximated by the ideal gas law, a general equation of state for gases:

$$pV = ZnRT$$

In this equation,  $p$  is pressure in psi,  $V$  is the gas volume in cubic feet,  $n$  is the number of moles of the gas,  $T$  is absolute temperature in R (degrees Rankine),  $R$  is the universal gas constant and equals to 10.73 psi ft<sup>3</sup>/lb-mol-R, and  $Z$  is the gas deviation factor or *Z-factor*, which may also be called the *super-compressibility factor* and is the ratio of the real

volume (the volume actually occupied by a gas at a given  $p$  and  $T$ ) to the ideal volume (volume it would occupy had it behaved as an ideal gas).

The gas deviation factor (a measure of the deviation of the gas from ideality) is an important gas property and it is involved in calculating gas properties such as the formation volume factor, density, compressibility, and viscosity. All of these properties are necessary in calculating initial gas-in-place (and, thus, reserves), predicting future gas production, and designing production tubing and pipelines. The *Z factor* can be determined in a PVT laboratory. In common practice it is calculated from published charts.





# Gas Formation Volume Factor

The gas formation volume factor is used to relate the volume of gas, as measured at reservoir conditions, to the volume of gas as measured at standard conditions (60 °F, 14.7 psia). Thus, it is the ratio of volume of 1 mol of gas at a given pressure and temperature to the volume of 1 mole of gas at standard conditions ( $P_s$  and  $T_s$ ). Using the real gas law and assuming that the  $Z$  factor at standard conditions is 1, the equation for formation volume factor ( $B_g$ ) can be written as:

$$B_g = \frac{V_R}{V_s} = \frac{nZRT}{P} \frac{P_s}{nZ_sRT_s} = \frac{P_s Z T}{T_s P}$$

when  $P_s$  is 1 atmosphere (14.6959 psia or 101.325 kPa) and  $T_s$  is 60 °F (519.67 °R or 288.71 °K), this equation can be written in three well-known standard forms:

$$B_g = 0.0283 \frac{ZT}{P}$$

where  $B_g$  is in ft<sup>3</sup>/SCF,  $P$  is in psia, and  $T$  is in degrees Rankine. Alternately,

$$B_g = 0.3507 \frac{ZT}{P}$$

where  $B_g$  is in m<sup>3</sup>/Sm<sup>3</sup>,  $P$  is in KPa, and  $T$  is in °K.

In some cases, it is more convenient to define the value of  $B_g$  in bbl/SCF. The equation can be written as:

$$B_g = 0.005 \frac{ZT}{P}$$

where  $T$  is in °R and  $P$  is in psia.



# Gas Laws

Natural gas, and the petroleum-derived gases before separation, is typically a non-ideal gas and follows the gas law:

$$PV = nZRT$$

$P$  is the pressure,  $V$  is the volume,  $T$  is the absolute temperature (degree Kelvin),  $Z$  is the compressibility factor,  $n$  is the number of kilo-moles of the gas and  $R$  is the gas constant. For example, if all other factors remained constant, when the volume of a certain mass of gas is reduced by 50%, the pressure would double and so on. As a gas, it would expand to fill any volume it is in. However, the compressibility,  $Z$ , is the factor that differentiates natural gas from an ideal gas. For methane,  $Z$  is 1 at 1 bar but decreases to 0.85 at 100 bar, both at 25 °C, that is, it compresses to a smaller volume than the proportional relationship.

## *Boyle's Law: The Pressure-Volume Law*

*Boyle's law* or the *pressure-volume law* states that the volume of a given amount of gas held at constant temperature varies inversely with the applied pressure when the temperature and mass are constant.

$$V \propto \frac{1}{P}$$

Another way of describing it is to say that their products are constant.

$$PV = C$$

When pressure increases, the volume decreases. When volume increases, the pressure decreases. From the equation above, this can be derived:

$$P_1 V_1 = P_2 V_2 = P_3 V_3 \text{ etc.}$$

This equation states that the product of the initial volume and pressure is equal to the product of the volume and pressure after a change in one of them under constant temperature.

## *Charles' Law: The Temperature-Volume Law*

This law states that the volume of a given amount of gas held at constant pressure is directly proportional to the Kelvin temperature.

$$V \propto T$$

A constant can be inserted:

$$V/T = C$$

As the volume increases, the temperature also increases, and vice-versa. Also, same as before, initial and final volumes and temperatures under constant pressure can be calculated.

$$V_1/T_1 = V_2/T_2 = V_3/T_3 \text{ etc.}$$

## *Gay-Lussac's Law: The Pressure Temperature Law*

This law states that the pressure of a given amount of gas held at constant volume is directly proportional to the Kelvin temperature.

$$P \propto T$$

A constant can be inserted:

$$P/T = C$$

As the pressure increases, the temperature also increases, and vice-versa. Also, initial and final volumes and temperatures under constant pressure can be calculated:

$$P_1/T_1 = P_2/T_2 = P_3/T_3 \text{ etc.}$$

## *Avogadro's Law: The Volume Amount Law*

This law gives the relationship between volume and amount when pressure and temperature are held constant. Remember, amount is measured in moles. Also, since volume is one of the variables, that means the container holding the gas is flexible in some way and can expand or contract. If the amount of gas in a container is increased, the volume

increases. If the amount of gas in a container is decreased, the volume decreases:

$$V \propto n$$

A constant can be inserted:

$$V/n = C$$

This means that the volume-amount fraction will always be the same value if the pressure and temperature remain constant.

$$V_1/n_1 = V_2/n_2 = V_3/n_3 \text{ etc.}$$

### The Combined Gas Law

In the Combined Gas Law, the relevant data from above can be combined into one proportion:

$$V \propto \frac{T}{P}$$

The volume of a given amount of gas is proportional to the ratio of its Kelvin temperature and its pressure. A constant can be inserted:

$$PV/T = C$$

As the pressure increases, the temperature also increases, and vice-versa. Also same as before, initial and final volumes and temperatures under constant pressure can be calculated:

$$P_1 V_1 / T_1 = P_2 V_2 / T_2 = P_3 V_3 / T_3 \text{ etc.}$$

### The Ideal Gas Law

The previous laws all assume that the gas being measured is an *ideal gas*, a gas that obeys them all exactly. But over a wide range of temperature, pressure, and volume, real gases deviate slightly from ideal. Since, according to Avogadro, the same volumes of gas contain the same number of moles, chemists could now determine the formulas of gaseous elements and their formula masses. The ideal gas law is:

$$PV = nRT$$

where  $n$  is the number of moles of the number of moles and  $R$  is the *universal gas constant* and is equal to approximately 0.0821 L-atm/mole-K.

### Other Forms of the Gas Law

If the definition of the mole is included in the equation, the result is:

$$PV = gRT/FW$$

or

$$FW = gRT/PV$$

This equation provides a convenient way of determining the formula weight of a gas if mass, temperature, volume and pressure of the gas are known (or can be determined).

### Dalton's Law of Partial Pressures

*Dalton's Law of Partial Pressures* states that the total pressure of a mixture of non-reacting gases is the sum of their individual partial pressures.

$$P_{\text{total}} = P_a + P_b + P_c + \dots$$

or

$$P_{\text{total}} = n_a RT/V + n_b RT/V + n_c RT/V + \dots$$

or

$$P_{\text{total}} = (n_a + n_b + n_c + \dots)RT/V$$

The pressure in a flask containing a mixture of 1 mole of 0.20 mole  $O_2$  and 0.80 mole  $N_2$  would be the same as the same flask holding 1 mole of  $O_2$ .

Partial pressures are useful when gases are collected by bubbling through water (displacement). The gas collected is saturated in water vapor which contributes to the total number of moles of gas in the container.

### Non-Ideal Gases

The ideal gas equation ( $PV = nRT$ ) provides a valuable model of the relations between volume, pressure, temperature and number of particles in a gas. As an ideal model it serves as a reference for the behavior of real gases. The ideal gas equation makes some simplifying assumptions which are obviously not quite true. Real molecules do have volume and do attract each other. All gases depart from ideal behavior under conditions of low temperature (when liquefaction begins) and high pressure (molecules are more crowded so the volume of the molecule becomes important). Refinements to the ideal gas equation can be made to correct for these deviations. The van der Waals equation for  $n$  moles of gas is:

$$\left( P + \frac{n^2 a}{V^2} \right) (V - nb) = nRT$$

Finally, a *real gas*, as opposed to an *ideal gas*, refers to an assumption base where the following are taken into account: (1) compressibility effects, (2) variable heat capacity, (3) van der Waals forces, (4) non-equilibrium thermodynamic effects, and (5) effects from molecular dissociation and elementary reactions with variable composition. For most applications, such a detailed analysis is unnecessary and the ideal gas approximation is used. Real-gas models have to be used (1) near the condensation point of gases, (2) near the critical point, and (3) at very high pressures.

The units of pressure that are used are pascal (Pa), standard atmosphere (atm), and torr. 1 atm is the average pressure at sea level, which is normally used as a standard unit of pressure. The SI unit is the pascal and 101,325 pascals equals 1 atm. A torr is the same unit as the mm Hg (millimeter of mercury); thus, 760 torr equals 1 atm.

**Table** Empirically determined values for the constants  $a$  and  $b$ .

<b>Molecule</b>	<b><math>a</math> (liters<sup>2</sup>-atm/mole<sup>2</sup>)</b>	<b><math>b</math> (liters/mole)</b>
H <sub>2</sub>	0.2444	0.02661
O <sub>2</sub>	1.360	0.03183
N <sub>2</sub>	1.390	0.03913
CO <sub>2</sub>	3.592	0.04267
Cl <sub>2</sub>	6.493	0.05622
Ar	1.345	0.03219
Ne	0.2107	0.01709
He	0.03412	0.02370



# Gas Processing – Hydrogen Sulfide Conversion

The disposition of hydrogen sulfide is an issue with many gas processing operations. Burning hydrogen sulfide as a fuel gas component or as a flare gas component is precluded by safety and environmental considerations since one of the combustion products is the highly toxic sulfur dioxide (SO<sub>2</sub>), which is also toxic.

Hydrogen sulfide is typically removed from gas streams through an *olamine* process, after which application of heat regenerates the olamine and forms an acid gas stream (also called the *tail gas* stream). Following from this, the acid gas stream is treated to convert the hydrogen sulfide elemental sulfur and water. The conversion process utilized in most modern refineries is the *Claus process*, or a variant thereof. The Claus process (Figure) involves combustion of approximately one-third of the hydrogen sulfide to sulfur dioxide and then reaction of the sulfur dioxide with the remaining hydrogen sulfide in the presence of a fixed bed of activated alumina, cobalt molybdenum catalyst resulting in the formation of elemental sulfur:

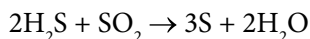
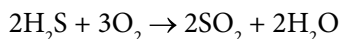

Different process flow configurations are in use to achieve the correct hydrogen sulfide/sulfur dioxide ratio in the conversion reactors.

Overall, conversion of 96 to 97% v/v of the hydrogen sulfide to elemental sulfur is achievable in a Claus process. If this is insufficient to meet air quality regulations, a Claus process tail gas treater is utilized to remove essentially the entire remaining hydrogen sulfide in the tail gas from the Claus unit. The tail gas treater may employ a proprietary solution to absorb the hydrogen sulfide followed by conversion to elemental sulfur.

The SCOT (Shell Claus Off-gas Treating) unit is also used to treat *tail gas* and uses a hydrotreating reactor followed by amine scrubbing to recover and recycle sulfur, in the form of hydrogen, to the Claus unit. In the process, tail

gas (containing hydrogen sulfide and sulfur dioxide) is contacted with hydrogen and reduced in a hydrotreating reactor to form hydrogen sulfide and water. The catalyst is typically cobalt/molybdenum on alumina. The gas is then cooled in a water contractor. The hydrogen sulfide-containing gas enters an amine absorber which is typically in a system segregated from the other refinery amine systems. The purpose of segregation is two-fold: (1) the tail gas treater frequently uses a different amine than the rest of the plant, and (2) the tail gas is frequently cleaner than the refinery fuel gas (in regard to contaminants) and segregation of the systems reduces maintenance requirements for the SCOT® unit. Amines chosen for use in the tail gas system tend to be more selective for hydrogen sulfide and are not affected by the high levels of carbon dioxide in the off-gas.

The hydrotreating reactor converts sulfur dioxide in the off-gas to hydrogen sulfide that is then contacted with a Stretford solution (a mixture of a vanadium salt, anthraquinone disulfonic acid, sodium carbonate, and sodium hydroxide) in a liquid-gas absorber. The hydrogen sulfide reacts stepwise with sodium carbonate and the anthraquinone sulfonic acid to produce elemental sulfur, with vanadium serving as a catalyst.

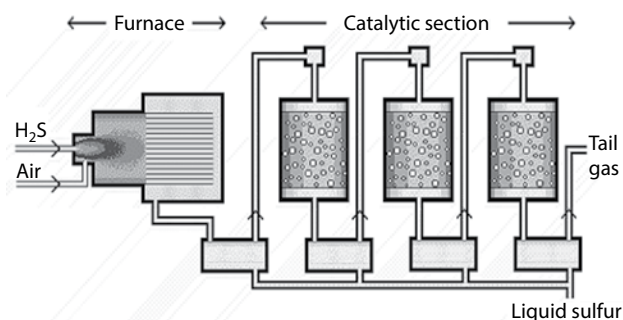
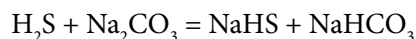
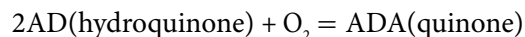
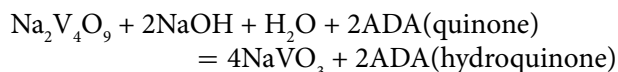
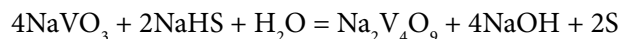

Figure The Claus process.



The solution proceeds to a tank where oxygen is added to regenerate the reactants. One or more froth or slurry tanks are used to skim the product sulfur from the solution, which is recirculated to the absorber.

Tail gas treating involves the removal of the remaining sulfur compounds from gases remaining after sulfur recovery. Tail gas from a typical Claus process, whether a conventional Claus or one of the extended versions of the process, usually contains small but varying quantities of carbonyl sulfide, carbon disulfide, hydrogen sulfide, and sulfur dioxide as well as sulfur vapor. In addition, there may be hydrogen, carbon monoxide, and carbon dioxide in the tail gas. In order to remove the rest of the sulfur compounds from the tail gas, all of the sulfur bearing species must first be converted to hydrogen sulfide, which is then absorbed into a solvent and the clean gas vented or recycled for further processing. Other tail gas treating processes include: (1) caustic scrubbing, (2) polyethylene glycol treatment, (3) Selectox process, (4) sulfite/bisulfite tail gas treating.

Liquid redox sulfur recovery processes are liquid-phase oxidation processes which use a dilute aqueous solution of iron or vanadium to remove hydrogen sulfide selectively by chemical absorption from sour gas streams. These processes can be used on relatively small or dilute hydrogen sulfide stream to recover sulfur from the acid gas stream or, in

some cases, they can be used in place of an acid gas removal process. The mildly alkaline lean liquid scrubs the hydrogen sulfide from the inlet gas stream, and the catalyst oxidizes the hydrogen sulfide to elemental sulfur. The reduced catalyst is regenerated by contact with air in the oxidizer(s). Sulfur is removed from the solution by flotation or settling, depending on the process.

The wet oxidation processes are based on reduction-oxidation (Redox) chemistry to oxidize the hydrogen sulfide to elemental sulfur in an alkaline solution containing an oxygen carrier. Vanadium and iron are the two oxygen carriers that are used. The best example of a process using the vanadium carrier is the Stretford process. The most prominent examples of the processes using iron as a carrier are the LO-CAT process and the SulFerox process. The Stretford process using vanadium finds little use now because of the toxic nature of the vanadium solution and iron-based processes are more common.

The LO-CAT process and the SulFerox process are essentially the same in principle. The SulFerox process differs from the LO-CAT in that the oxidation and the regeneration steps are carried out in separate vessels and sulfur is recovered from the filters, melted, and sent to sulfur storage. Also, the SulFerox process uses a higher concentration of iron chelates (about 2 to 4% by weight vs. 0.025 to 0.3% by weight for the LO-CAT process). Both processes are capable of up to 99+% w/w sulfur recovery. However, using the processes for Claus tail gas treating requires hydrolysis of all the sulfur dioxide in the tail gas to hydrogen sulfide because the sulfur dioxide will react with the buffering base potassium hydroxide (KOH) and form potassium sulfate ( $\text{K}_2\text{SO}_4$ ) which will consume the buffering solution and quickly saturate it.



## Gas Processing – Metal Oxide Processes

The most well-known hydrogen sulfide removal process is based on the reaction of hydrogen sulfide with iron oxide (*iron sponge process, dry box method*) in which the gas is passed through a bed of wood chips impregnated with iron oxide. The process is one of several metal oxide-based processes that scavenge hydrogen sulfide and organic sulfur compounds (mercaptans) from gas streams through reactions with the solid based chemical adsorbent. The process is governed by the reaction of a metal oxide with hydrogen sulfide to form the metal sulfide. For regeneration, the metal oxide is reacted with oxygen to produce elemental sulfur and the regenerated metal oxide.

The iron oxide process is the oldest and still the most widely used batch process for sweetening natural gas and natural gas liquids. The process was implemented during the 19<sup>th</sup> century. In the process (Figure) the sour gas is passed down through the bed. In the case where continuous regeneration is to be utilized a small concentration of air is added to the sour gas before it is processed. This air serves to continuously regenerate the iron oxide, which has reacted with hydrogen sulfide, which serves to extend the on-stream life of a given tower but probably serves to decrease the total amount of sulfur that a given weight of bed will remove. The process is usually best applied to gases containing low to medium concentrations (300 ppm) of hydrogen sulfide or mercaptans. This process tends to be highly selective and does not normally remove significant quantities of carbon dioxide. As a result, the hydrogen sulfide stream from the process is usually high purity. The use of iron sponge process for sweetening sour gas is based on adsorption of the acid gases on the surface of the solid sweetening agent followed by chemical reaction of ferric oxide ( $\text{Fe}_2\text{O}_3$ ) with hydrogen sulfide:

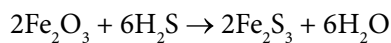

The reaction requires the presence of slightly alkaline water and a temperature below 43 °C (110 °F) and bed

alkalinity (pH + 8 to 10) should be checked regularly, usually on a daily basis. The pH level is maintained through the injection of caustic soda with the water. If the gas does not contain sufficient water vapor, water may need to be injected into the inlet gas stream.

The ferric sulfide produced by the reaction of hydrogen sulfide with ferric oxide can be oxidized with air to produce sulfur and regenerate the ferric oxide:

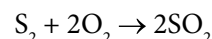
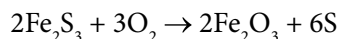

The regeneration step is exothermic and air must be introduced slowly so the heat of reaction can be dissipated. If air is introduced quickly the heat of reaction may ignite the bed. Some of the elemental sulfur produced in the regeneration step remains in the bed. After several cycles this sulfur will form a cake over the ferric oxide, decreasing the reactivity of the bed. Typically, after 10 cycles the bed must be removed and a new bed introduced into the vessel.

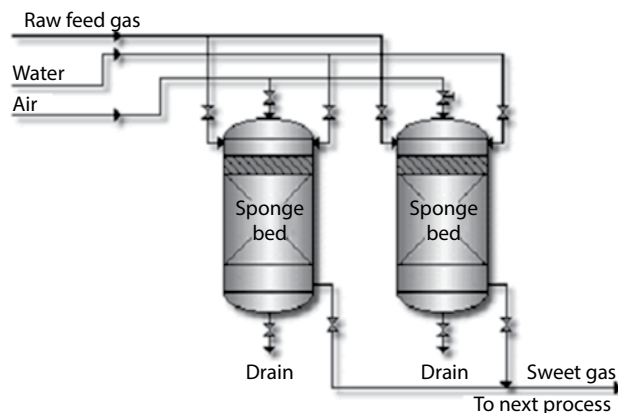

**Figure** The iron oxide (Iron sponge) process.

Removal of larger amounts of hydrogen sulfide from gas streams requires a continuous process, such as the Ferrox process or the Stretford process. The *Ferrox process* is based on the same chemistry as the iron oxide process except that it is fluid and continuous. The *Stretford process* employs a solution containing vanadium salts and

anthraquinone disulfonic acid. Most hydrogen sulfide removal processes return the hydrogen sulfide unchanged, but if the quantity involved does not justify installation of a sulfur recovery plant (usually a Claus plant) it is necessary to select a process that directly produces elemental sulfur.

## Gas Processing – Oamine Processes

The primary process (Figure) for sweetening sour natural gas is quite similar to the processes of glycol dehydration and removal of natural gas liquids by absorption. In this case, however, amine (*olamine*) solutions are used to remove the hydrogen sulfide (the *amine process*). The sour gas is run through a tower, which contains the olamine solution. There are two principle amine solutions used, monoethanolamine (MEA) and diethanolamine (DEA). Either of these compounds, in liquid form, will absorb sulfur compounds from natural gas as it passes through. The effluent gas is virtually free of sulfur compounds, and thus loses its sour gas status. Like the process for the extraction of natural gas liquids and glycol dehydration, the amine solution used can be regenerated for reuse.

Amine derivatives such as ethanolamine (monoethanolamine, MEA), diethanolamine (DEA), triethanolamine (TEA), methyldiethanolamine (MDEA), diisopropanolamine (DIPA), and diglycolamine (DGA) are the most widely used *olamines* in commercial applications (Table). They are selected according to their relative ability to interact with and remove carbon dioxide and/or hydrogen sulfide.

The chemistry can be represented by simple equations for low partial pressures of the acid gases:

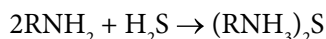

At high acid gas partial pressure, the reactions will lead to the formation of other products:

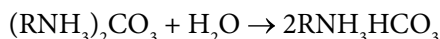
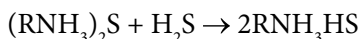

The reaction is extremely fast – the absorption of hydrogen sulfide being limited only by mass transfer; this is not so for carbon dioxide. Regeneration of the solution leads to near complete desorption of carbon dioxide and hydrogen sulfide. A comparison between monoethanolamine, diethanolamine, and diisopropanolamine shows that

monoethanolamine is the cheapest of the three but shows the highest heat of reaction and corrosion; the reverse is true for diisopropanolamine.

The processes using ethanolamine and potassium phosphate are now widely used. The ethanolamine process, known as the *Girbotol* process, removes acid gases (hydrogen sulfide and carbon dioxide) from liquid hydrocarbons as well as from natural and from refinery gases. The Girbotol process uses an aqueous solution of ethanolamine ( $\text{H}_2\text{NCH}_2\text{CH}_2\text{OH}$ ) that reacts with hydrogen sulfide at low temperatures and releases hydrogen sulfide at high temperatures. The ethanolamine solution fills a tower called an absorber through which the sour gas is bubbled. Purified gas leaves the top of the tower, and the ethanolamine solution leaves the bottom of the tower with the absorbed acid gases. The ethanolamine solution enters a reactivator tower where heat drives the acid gases from the solution. Ethanolamine solution, restored to its original condition, leaves the bottom of the reactivator tower to go to the top of the absorber tower, and acid gases are released from the top of the reactivator.

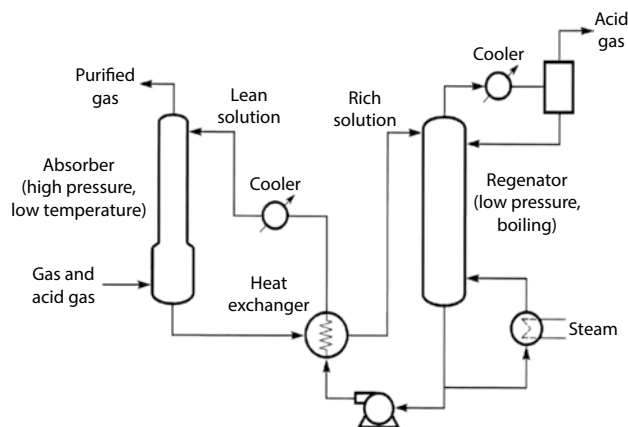

Figure The olamine (Amine) process.

**Table** Oamines used for gas processing.

Oamine	Formula	Derived name	Molecular weight	Specific gravity	Melting point, °C	Boiling point, °C	Flash point, °C	Relative capacity %
Ethanolamine (monoethanolamine)	$\text{HOC}_2\text{H}_4\text{NH}_2$	MEA	61.08	1.01	10	170	85	100
Diethanolamine	$(\text{HOC}_2\text{H}_4)_2\text{NH}$	DEA	105.14	1.097	27	217	169	58
Triethanolamine	$(\text{HOC}_2\text{H}_4)_3\text{N}$	TEA	148.19	1.124	18	335, d	185	41
Diglycolamine (hydroxyethanolamine)	$\text{H}(\text{OC}_2\text{H}_4)_2\text{NH}_2$	DGA	105.14	1.057	-11	223	127	58
Diisopropanolamine	$(\text{HOC}_3\text{H}_6)_2\text{NH}$	DIPA	133.19	0.99	42	248	127	46
Methyldiethanolamine	$(\text{HOC}_2\text{H}_4)_2\text{NCH}_3$	MDEA	119.17	1.03	-21	247	127	51

d: with decomposition.

# Gas Processing – Sweetening

Many chemical processes are available for sweetening natural gas (Table). For decades, the amine (olamine) process (also known as the Girdler process), has been the most widely used method for removal of hydrogen sulfide:

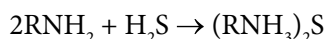

In this equation, R is mono, di, or tri-ethanol, N is nitrogen, H is hydrogen, and S is sulfur.

The recovered hydrogen sulfide gas stream may be: (1) vented, (2) flared in waste gas flares or modern smokeless flares, (3) incinerated, or (4) utilized for the production of elemental sulfur or sulfuric acid. If the recovered hydrogen sulfide gas stream is not to be utilized as a feedstock for commercial applications, the gas is usually passed to a tail gas incinerator in which the hydrogen sulfide is oxidized to sulfur dioxide and water for further processing of the sulfur dioxide.

**Table** Summary of the Natural Gas Sweetening Processes

## Iron-Sponge Sweetening

Reaction:

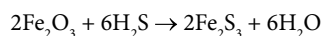

Regeneration:

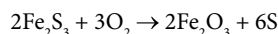

A batch process; most applicable for small gas volume with low content of hydrogen sulfide; operating temperature of the vessel <120 °F (<49 °C).

## Alkanolamine Sweetening

Reaction:

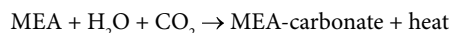

Regeneration:

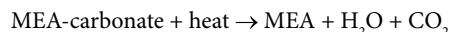
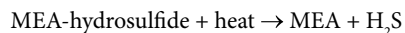

Alkanolamine: organic compounds including monoethanolamine (MEA), diethanolamine (DEA), and triethanolamine (TEA); not selective and have to be designed for total acid-gases removal; operating  $p > 125$  psi for DEA; can absorb most of the acid gases and meet the specified pipeline requirement.

## Glycol/Amine Process

A solution composed of 10–30% w/w MEA, 45–85% w/w glycol, and 5–25% w/w water for the simultaneous removal of water vapor, hydrogen sulfide, and carbon dioxide; the process flow scheme is essentially the same as that for MEA; applicable when low dew point is not required; there can be losses of MEA due to vaporization in the regeneration stage at high temperature.

(Continued)

Table Cont.

**Sulfinol Process**

The solvent (composed of sulfolane, diisopropanolamine (DIPA), and water) acts as the physical (sulfolane) and chemical (DIPA) solvent; there is the benefit of low solvent circulation rates, smaller equipment, and lower cost; on the other hand, there can be absorption of high molecular weight hydrocarbon derivatives and aromatic derivatives.

**Chemsweet Process and Zinc Oxide Process**

Reaction:

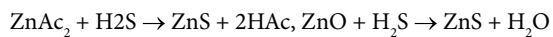

Regeneration:

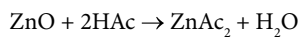

Can be used to treat gas with a high concentration of hydrogen sulfide; operating  $p$  on the order of 89 to 1,415 psi; should not be used when the mercaptan concentration is in excess of 10% v/v hydrogen sulfide in the gas stream – mercaptans react with ZnO and forms Zn(OH)RH which will form a sludge and possibly cause foaming problems.

# Gas Processing – Absorption and Adsorption Processes

*Absorption* is an approach in which the absorbed gas is ultimately distributed throughout the absorbent (liquid) and is one of several methods used for removal of hydrogen sulfide and carbon dioxide (Figure). The process depends only on physical solubility and may include chemical reactions in the liquid phase (*chemisorption*). Common absorbing media used are water, aqueous amine solutions, caustic, sodium carbonate, and non-volatile hydrocarbon oils, depending on the type of gas to be absorbed. Usually, the gas-liquid contactor designs which are employed are plate columns or packed beds. Absorption is achieved by dissolution (a physical phenomenon) or by reaction (a chemical phenomenon). Chemical adsorption processes adsorb sulfur dioxide onto a carbon surface where it is oxidized (by oxygen in the flue gas) and absorbs moisture to give sulfuric acid impregnated into and on the adsorbent.

The absorption method of extraction is very similar to using absorption for dehydration. The main difference is that, in the absorption of natural gas liquids, absorbing oil is used as opposed to glycol. This absorbing oil has an affinity for natural gas liquids in much the same manner as glycol has an affinity for water. Before the oil has picked up any natural gas liquids, it is termed *lean* absorption oil.

In the glycol absorption process, the glycol (a hygroscopic liquid) is used to contact the *wet* gas to remove water vapor from it. Triethylene glycol (TEG) is the most common solvent used. Absorption, which is defined as the transfer of a component from the gas phase to the liquid phase, is more favorable at a *lower temperature and higher pressure*. Thus: using a combination of Raoult's law and Dalton's law:

$$\frac{P_i}{P} = \frac{Y_i}{X_i} = K_i$$

In the equation,  $P_i$  is the pressure of pure component  $i$ ,  $P$  is the total pressure of the gas mixture (system),  $X_i$  is the

mole fraction of component  $i$  in the liquid phase,  $Y_i$  is the mole fraction of component  $i$  in the vapor phase, and  $K_i$  is the equilibrium constant, increasing with temperature and decreasing with pressure.

If the temperature decreases and  $P$  remains constant,  $P_i$  decreases and, as a result, the water vapor concentration in the gas,  $Y_i$  decreases, allowing more absorption of water in the liquid phase. The same conclusion is reached if the total pressure  $P$  is increased.

The actual absorption process of water vapor from the gas phase using glycol is dynamic and continuous. Therefore, the gas flow cannot be stopped to let a vapor and the liquid reach an equilibrium condition. Accordingly, the system under consideration must be designed to allow for a close approach to equilibrium while the flow continues. Two means are provided to accomplish this task for a countercurrent flow of the feed natural gas and liquid (solvent or glycol): (1) tray column, or stage wise operation – the equilibrium concept, and (2) packed column or continuous-contact operation – the rate concept. This countercurrent system allows for the wet gas to enter the bottom of the column and contact the *rich* glycol (high water content) at its exit point. On the other hand, as the gas works its way up the column, it encounters the *leanest* glycol (lowest water content) before the gas leaves the column.

The *oil absorption process* involves the countercurrent contact of the lean (or stripped) oil with the incoming wet gas with the temperature and pressure conditions programmed to maximize the dissolution of the liquefiable components in the oil. The *rich* absorption oil (sometimes referred to as *fat* oil), containing natural gas liquids, exits the absorption tower through the bottom. It is now a mixture of absorption oil, propane, butanes, pentanes, and other higher boiling hydrocarbons. The rich oil is fed into lean oil stills, where the mixture is heated to a temperature above the boiling point

of the natural gas liquids but below that of the oil. This process allows for the recovery of around 75% by volume of the butanes, and 85 to 90% by volume of the pentanes and higher boiling constituents from the natural gas stream.

The basic absorption process above can be modified to improve its effectiveness, or to target the extraction of specific natural gas liquids. In the refrigerated oil absorption method, where the lean oil is cooled through refrigeration, propane recovery can be upwards of 90% by volume and approximately 40% by volume of the ethane can be extracted from the natural gas stream. Extraction of the other, higher boiling natural gas liquids can be close to 100% by volume using this process.

The absorption method, on the other hand, uses an absorbing oil to separate the methane from the natural gas liquids. While the gas stream is passed through an absorption tower, the absorption oil (*lean oil*) soaks up a large amount of the natural gas liquids. The absorption oil (*enriched oil*), now containing natural gas liquids, exits the base of the tower after which the enriched oil is fed into distillers where the blend is heated to above the boiling point of the natural gas liquids, while the oil remains fluid. The absorption oil is recycled while the natural gas liquids are cooled and directed to a fractionator tower. Another absorption method that is often used is the refrigerated oil absorption method where the lean oil is chilled rather than heated, a feature that has the potential to enhance recovery rates.

*Adsorption* differs from *absorption* in that it is a physical-chemical phenomenon in which the gas is concentrated on the surface of a solid or liquid to remove impurities. Usually, carbon is the adsorbing medium, which can be regenerated upon *desorption*. The quantity of material adsorbed is proportional to the surface area of the solid and, consequently, adsorbents are usually granular solids with a large surface area per unit mass. Subsequently, the captured gas can be desorbed with hot air or steam either for recovery or for thermal destruction.

The number of steps and the type of process used to produce pipeline-quality natural gas most often depends upon the source and makeup of the wellhead production stream. In some cases, several of the steps (Figure) may be integrated into one unit or operation, performed in a different order or at alternative locations, or not required at all.

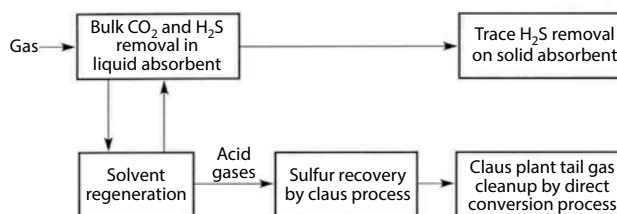

**Figure** Processes for hydrogen sulfide and carbon dioxide removal.



# Gas Processing – Acid Gas Removal

In addition to water and natural gas liquids removal, one of the most important parts of gas processing involves the removal of hydrogen sulfide and carbon dioxide. Natural gas from some wells contains significant amounts of hydrogen sulfide and carbon dioxide and is usually referred to as *sour gas*. Sour gas is undesirable because the sulfur compounds it contains can be extremely harmful, even lethal, to breathe and the gas can also be extremely corrosive. The process for removing hydrogen sulfide from sour gas is commonly referred to as *sweetening* the gas.

Acid gas removal (i.e., removal of carbon dioxide and hydrogen sulfide from natural gas streams) is achieved by application of one or both of the following process types: (1) absorption and, (2) adsorption. As currently practiced, acid gas removal processes involve the selective absorption of the contaminants into a liquid, which is passed counter-current to the gas. Then the absorbent is stripped of the gas components (regeneration) and recycled to the absorber. The process design will vary and, in practice, may employ multiple absorption columns and multiple regeneration columns.

Liquid absorption processes (which usually employ temperatures below 50 °C (120 °F) are classified either as *physical solvent processes* or *chemical solvent processes*. The former processes employ an organic solvent, and absorption is enhanced by low temperatures, or high pressure, or both.

Regeneration of the solvent is often accomplished readily. In chemical solvent processes, absorption of the acid gases is achieved mainly by use of alkaline solutions such as amines or carbonates. Regeneration (desorption) can be brought about by use of reduced pressures and/or high temperatures, whereby the acid gases are stripped from the solvent.

Adsorber units are widely used to increase a low gas concentration prior to incineration unless the gas concentration is very high in the inlet air stream. Adsorption also is employed to reduce problem odors from gases. There are several limitations to the use of adsorption systems, but it is generally felt that the major one is the requirement for minimization of particulate matter and/or condensation of liquids (e.g., water vapor) that could mask the adsorption surface and drastically reduce its efficiency.

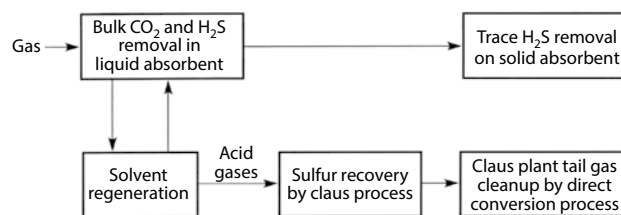
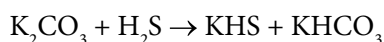
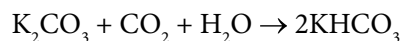

**Figure** Processes for removal of acid gases from gas streams.



## Gas Processing – Carbonate and Water Washing Processes

*Carbonate washing* is a *chemical conversion process*, in which contaminants in natural gas are converted to compounds that are not objectionable or that can be removed from the stream with greater ease than the original constituents. In the carbonate processes, hydrogen sulfide and sulfur dioxide are removed from gas streams by reaction with an alkaline solution and uses the principle that the rate of absorption of carbon dioxide by potassium carbonate increases with temperature. It has been demonstrated that the process works best near the temperature of reversibility of the reactions:



*Water washing*, in terms of the outcome, is analogous to washing with potassium carbonate (Kohl and Riesenfeld, 1985). Acid gas removal is purely physical and there is also a relatively high absorption of hydrocarbons, which are liberated at the same time as the acid gases during the regeneration step.

The process using potassium phosphate is known as phosphate desulfurization, and it is used in the same way as the Girbotol process to remove acid gases from liquid hydrocarbons as well as from gas streams. The treatment solution is a water solution of potassium phosphate ( $\text{K}_3\text{PO}_4$ ), which is circulated through an absorber tower and a reactivator tower in much the same way as the ethanolamine is circulated in the Girbotol process; the solution is regenerated thermally. Other processes include the *Alkazid process* for removal of hydrogen sulfide and carbon dioxide using concentrated aqueous solutions of amino acids. The hot potassium carbonate process decreases the acid content of natural and refinery gas from as much as 50% to as low as 0.5% and operates in a unit similar to that used for amine treating. The *Giammarco-Vetrocoke* process is used for hydrogen sulfide and/or carbon dioxide removal. In the hydrogen sulfide removal section, the reagent consists of sodium or potassium carbonates containing a mixture of arsenites and arsenates; the carbon dioxide removal section utilizes hot aqueous alkali carbonate solution activated by arsenic trioxide or selenous acid or tellurous acid.



## Gas Processing – Catalytic Oxidation Processes

*Catalytic oxidation* is a chemical conversion process that is used predominantly for destruction of volatile organic compounds and carbon monoxide. These systems operate in a temperature regime of 205 to 595 °C (400 to 1100 °F) in the presence of a catalyst. Without the catalyst, the system would require higher temperatures. Typically, the catalysts used are a combination of noble metals deposited on a ceramic base in a variety of configurations (e.g., honeycomb-shaped) to enhance good surface contact. Thermal oxidation systems, without the use of catalysts, also involve chemical conversion (more correctly, chemical destruction) and operate at temperatures in excess of

815 °C (1500 °F), or 220 to 610 °C (395 to 1100 °F) higher than catalytic systems.

Catalytic systems are usually classified on the basis of bed types such as *fixed bed* (or *packed bed*) and *fluid bed* (*fluidized bed*). These systems generally have very high destruction efficiencies for most volatile organic compounds, resulting in the formation of carbon dioxide, water, and varying amounts of hydrogen chloride (from halogenated hydrocarbons). The presence in emissions of chemicals such as heavy metals, phosphorus, sulfur, chlorine, and most halogens in the incoming air stream act as poison to the system and can foul the catalyst.



## Gas Processing - Fractionation

Fractionation is the process of separating the various natural gas liquids present in the remaining gas stream by using the varying boiling points of the individual hydrocarbons in the gas stream. The process occurs in stages as the gas stream rises through several towers where heating units raise the temperature of the stream, causing the various liquids to separate and exit into specific holding tanks.

*Fractionation processes* are very similar to those processes classed as *liquids removal* processes but often appear to be more specific in terms of the objectives: hence the need to place the fractionation processes into a separate category. The fractionation processes are those processes that are used (1) to remove the more significant product stream first, or (2) to remove any unwanted light ends from the heavier liquid products.

*Fractionation* operates on the basis of the different boiling points of the different hydrocarbons in the natural gas liquids stream. Essentially, fractionation occurs in stages consisting of the boiling off of hydrocarbons one by one. The name of a particular fractionator gives an idea as to its purpose, as it is conventionally named for the hydrocarbon

that is boiled off. The particular fractionators are used in the following order: (1) the *de-ethanizer* separates the ethane from the stream of natural gas liquids, (2) the *depropanizer* separates the propane from the de-ethanized stream, (3) the *debutanizer* separates the butanes from the higher boiling hydrocarbons, and (4) the *butane splitter* or *de-isobutanizer* separates the iso-butane and n-butane.

The purification of hydrocarbon gases by any of these processes is an important part of gas refining, especially in regard to the production of liquefied petroleum gas (LPG). This is actually a mixture of propane and butane, which is an important domestic fuel, as well as an intermediate material in the manufacture of petrochemicals. The presence of ethane in liquefied petroleum gas must be avoided because of the inability of this lighter hydrocarbon to liquefy under pressure at ambient temperatures and its tendency to register abnormally high pressures in the liquefied petroleum gas containers. In addition, the presence of pentane in liquefied petroleum gas must also be avoided, since this particular hydrocarbon (a liquid at ambient temperatures and pressures) may separate into a liquid state in the gas lines.





# Gas Processing – Gas-Oil Separation

In many instances pressure relief at the wellhead will cause a natural separation of gas from oil (using a conventional closed tank, where gravity separates the gas hydrocarbons from the higher boiling crude oil). In some cases, however, a multi-stage gas-oil separation process is needed to separate the gas stream from the crude oil. These *gas-oil separators* are commonly closed cylindrical shells, horizontally mounted with inlets at one end, an outlet at the top for removal of gas, and an outlet at the bottom for removal of oil but differ in their purpose and efficiency (Table). Separation is accomplished by alternately heating and cooling (by compression) the flow stream through multiple steps; some water and condensate, if present, will also be extracted as the process proceeds.

At some stage of the processing, the gas flow is directed to a unit that contains a series of filter tubes. As the velocity of the stream reduces in the unit, primary separation of

remaining contaminants occurs due to gravity. Separation of smaller particles occurs as gas flows through the tubes, where they combine into larger particles which flow to the lower section of the unit. Further, as the gas stream continues through the series of tubes, a centrifugal force is generated which further removes any remaining water and small solid particulate matter.

**Table** Types of liquid-gas separators.

Technology	Droplet size removed
Gravity separator	Down to 300 $\mu\text{m}$
Centrifugal separator	Down to 8–10 $\mu\text{m}$
Mist eliminator pad	Down to 10 $\mu\text{m}$
Vane separator	Down to 10 $\mu\text{m}$
High efficiency L/G coalescer	Down to 0.1 $\mu\text{m}$



# Gas Processing – Liquids Removal

Natural gas coming directly from a well contains many natural gas liquids that are commonly removed. In most instances, natural gas liquids (NGLs) have a higher value as separate products, and it is thus economical to remove them from the gas stream. The removal of natural gas liquids usually takes place in a relatively centralized processing plant, and uses techniques similar to those used to dehydrate natural gas. The justification for building a liquid recovery (or a liquid removal) plant depends on the (1) the specification for natural gas sold to the consumer and (2) the price differential between the enriched gas (containing the higher molecular weight hydrocarbons) and lean gas with the added value of the extracted liquid.

Condensates are most often removed from the gas stream at the wellhead through the use of mechanical separators. In most instances, the gas flow into the separator comes directly from the wellhead, since the gas-oil separation process is not needed. The gas stream enters the processing plant at high pressure (600 pounds per square inch

or greater) through an inlet slug catcher where free water is removed from the gas, after which it is directed to a condensate separator. Extracted condensate is routed to on-site storage tanks.

There are two basic steps to the treatment of natural gas liquids in the natural gas stream. First, the liquids must be *extracted* from the natural gas. Second, these natural gas liquids must be separated themselves, down to their base components (*fractionation*). These two processes account for approximately 90% of the total production of natural gas liquids.

There are three principal techniques for removing natural gas liquids from the natural gas stream: (1) the absorption method, (2) the cryogenic expander process, and (3) a membrane process.

The extraction of natural gas liquids from the natural gas stream produces both cleaner, purer natural gas, as well as the valuable hydrocarbons that are the natural gas liquids themselves.



## Gas Processing – Metal Oxide Processes

The most well-known hydrogen sulfide removal process is based on the reaction of hydrogen sulfide with iron oxide (*iron sponge process, dry box method*) in which the gas is passed through a bed of wood chips impregnated with iron oxide. The process is one of several metal oxide-based processes that scavenge hydrogen sulfide and organic sulfur compounds (mercaptans) from gas streams through reactions with the solid based chemical adsorbent. The process is governed by the reaction of a metal oxide with hydrogen sulfide to form the metal sulfide. For regeneration, the metal oxide is reacted with oxygen to produce elemental sulfur and the regenerated metal oxide.

The iron oxide process is the oldest and still the most widely used batch process for sweetening natural gas and natural gas liquids. The process was implemented during the 19<sup>th</sup> century. In the process (Figure) the sour gas is passed down through the bed. In the case where continuous regeneration is to be utilized a small concentration of air is added to the sour gas before it is processed. This air serves to continuously regenerate the iron oxide, which has reacted with hydrogen sulfide, which serves to extend the on-stream life of a given tower but probably serves to decrease the total

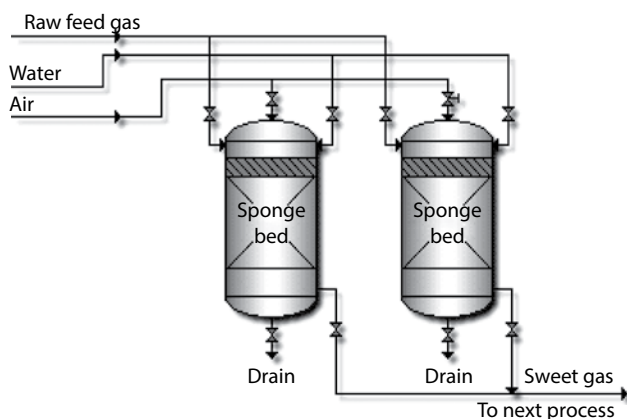

**Figure** The iron oxide (Iron sponge) process.

amount of sulfur that a given weight of bed will remove. The process is usually best applied to gases containing low to medium concentrations (300 ppm) of hydrogen sulfide or mercaptans. This process tends to be highly selective and does not normally remove significant quantities of carbon dioxide. As a result, the hydrogen sulfide stream from the process is usually high purity. The use of iron sponge process for sweetening sour gas is based on adsorption of the acid gases on the surface of the solid sweetening agent followed by chemical reaction of ferric oxide ( $\text{Fe}_2\text{O}_3$ ) with hydrogen sulfide:

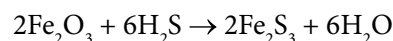

The reaction requires the presence of slightly alkaline water and a temperature below 43 °C (110 °F) and bed alkalinity (pH + 8 to 10) should be checked regularly, usually on a daily basis. The pH level is maintained through the injection of caustic soda with the water. If the gas does not contain sufficient water vapor, water may need to be injected into the inlet gas stream.

The ferric sulfide produced by the reaction of hydrogen sulfide with ferric oxide can be oxidized with air to produce sulfur and regenerate the ferric oxide:

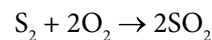
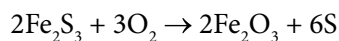

The regeneration step is exothermic and air must be introduced slowly so the heat of reaction can be dissipated. If air is introduced quickly the heat of reaction may ignite the bed. Some of the elemental sulfur produced in the regeneration step remains in the bed. After several cycles this sulfur will form a cake over the ferric oxide, decreasing the reactivity of the bed. Typically, after 10 cycles the bed must be removed and a new bed introduced into the vessel.

Removal of larger amounts of hydrogen sulfide from gas streams requires a continuous process, such as the

Ferrox process or the Stretford process. The *Ferrox process* is based on the same chemistry as the iron oxide process except that it is fluid and continuous. The *Stretford process* employs a solution containing vanadium salts and anthraquinone disulfonic acid. Most hydrogen sulfide

removal processes return the hydrogen sulfide unchanged, but if the quantity involved does not justify installation of a sulfur recovery plant (usually a Claus plant) it is necessary to select a process that directly produces elemental sulfur.

## Gas Processing – Methanol-Based Processes

Methanol is probably one of the most versatile solvents in the natural gas processing industry. Historically, methanol was the first commercial organic physical solvent and has been used for hydrate inhibition, dehydration, gas sweetening and liquids recovery. Most of these applications involve low temperature where methanol's physical properties are advantageous compared with other solvents that exhibit high viscosity problems or even solids formation. Operation at low temperatures tends to suppress methanol's most significant disadvantage, high solvent loss. Furthermore, methanol is relatively inexpensive and easy to produce, making the solvent a very attractive alternate for gas processing applications.

Methanol has favorable physical properties relative to other solvents except for vapor pressure. The benefits of the low viscosity of methanol at low temperature are manifested in the pressure drop improvement in the cold box of injection facilities and improved heat transfer. Methanol has a much lower surface tension relative to the other solvents. High surface tension tends to promote foaming problems in contactors. Methanol processes are probably not susceptible to foaming. However, the primary drawback of methanol is the high vapor pressure that is several times greater than that of the glycols or amines. To minimize methanol losses and enhance water and acid gas absorption, the absorber or separator temperatures are usually less than  $-20^{\circ}\text{F}$ .

The high vapor pressure of methanol may initially appear to be a significant drawback because of high solvent losses. However, the high vapor pressure also has significant advantages. Although often not considered, lack of thorough mixing of the gas and solvent can pose significant problems. Because of the high vapor pressure, methanol is completely mixed in the gas stream before the cold box. Glycol derivatives, because they do not completely vaporize, may require special nozzles and nozzle placement in the cold box to prevent freeze-up. Solvent carry-over to other downstream processes may also represent a significant problem. Since

methanol is more volatile than glycol derivatives, amine derivatives, and other physical solvents including lean oil, methanol is usually rejected in the regeneration step of these downstream processes. The stripper concentrates the methanol in the overhead condenser where it can be removed and further purified. Unfortunately, if glycols are carried over to amine units, the glycol becomes concentrated in the solution and potentially starts to degrade and possibly dilute the amine solution.

The use of methanol has been further exploited in the development of the Rectisol process either alone or as toluene-methanol mixtures are used to more selectively remove hydrogen sulfide and slip carbon dioxide to the overhead product. Toluene has an additional advantage insofar as carbonyl sulfide (COS) is more soluble in toluene than in methanol. The Rectisol process was primarily developed to remove both carbon dioxide and hydrogen sulfide (along with other sulfur-containing species) from gas streams resulting from the partial oxidation of coal, oil, and petroleum residua. The ability of methanol to absorb these unwanted components made it the natural solvent of choice. Unfortunately, at cold temperatures, methanol also has a high affinity for hydrocarbon constituents of the gas streams. For example, propane is more soluble in methanol than is carbon dioxide. There are two versions of the Rectisol process – the two-stage process and the once-through process. The first step of the two-stage process is desulfurization before shift conversion; the concentrations of hydrogen sulfide and carbon dioxide are about 1 and 5% v/v, respectively. Regeneration of the methanol following the desulfurization of the feed gas produces high sulfur feed for sulfur recovery. The once-through process is only applicable for high pressure partial oxidation products. The once-through process is also applicable when the hydrogen sulfide to carbon dioxide content is unfavorable, in the neighborhood of 1:50.

Recently, a process using methanol has been developed in which the simultaneous capability to dehydrate,

to remove acid gas, and to control hydrocarbon dew point. The IFPEXOL-1 is used for water removal and hydrocarbon dew point control; the IFPEXOL-2 process is used for acid gas removal. The novel concept behind the IFPEXOL-1 process is to use a portion of the water-saturated inlet feed to recover the methanol from the aqueous portion of the low temperature separator. That approach has solved a major problem with methanol injection in large facilities, the methanol recovery via distillation. Beyond that very simple discovery, the cold section of the process is remarkably similar to a basic methanol

injection process. Modifications to the process include water washing the hydrocarbon liquid from the low temperature separator to enhance the methanol recovery. The IFPEXOL-2 process for acid gas removal is very similar to an amine type process except for the operating temperatures. The absorber operates below  $-20^{\circ}\text{F}$  to minimize methanol losses, and the regenerator operates at about 90 psi. Cooling is required on the regenerator condenser to recover the methanol. This process usually follows the IFPEXOL-1 process so excessive hydrocarbon absorption is not as great a problem.



## Gas Processing – Molecular Sieve Processes

Molecular sieves are highly selective for the removal of hydrogen sulfide (as well as other sulfur compounds) from gas streams and offer continuously high absorption efficiency. They are also an effective means of water removal and thus offer a process for the simultaneous dehydration and desulfurization of gas. Gas that has excessively high water content may require upstream dehydration. The *molecular sieve process* is similar to the iron oxide process. Regeneration of the bed is achieved by passing heated clean gas over the bed. As the temperature of the bed increases, it releases the adsorbed hydrogen sulfide into the regeneration gas stream. The sour effluent regeneration gas is sent to a flare stack, and up to 2% of the gas treated can be lost in the regeneration process. A portion of the natural gas may also be lost by the adsorption of hydrocarbon components by the sieve.

In this process, unsaturated hydrocarbon components, such as olefins and aromatics, tend to be strongly

adsorbed by the molecular sieve. Molecular sieves are susceptible to poisoning by such chemicals as glycols and require thorough gas cleaning methods before the adsorption step. Alternatively, the sieve can be offered some degree of protection by the use of *guard beds* in which a less expensive catalyst is placed in the gas stream before contact of the gas with the sieve, thereby protecting the catalyst from poisoning. This concept is analogous to the use of guard beds or attrition catalysts in the petroleum industry.

Alumina *guard beds* (which serve as protectors by the act of attrition and may be referred to as an *attrition catalyst*) may be placed ahead of the molecular sieves to remove the sulfur compounds. Downflow reactors are commonly used for adsorption processes, with an upward flow regeneration of the adsorbent and cooling in the same direction as adsorption.



# Gas Processing – Nitrogen Removal

A significant fraction of many natural gas reserves is sub-quality (low heating value) due to the high nitrogen content of the gas. Gas containing more than about 6% nitrogen must be treated to remove the nitrogen. In many cases where nitrogen occurs in natural gas, the reserves cannot currently be exploited because of the lack of suitable nitrogen removal technology.

The separation of methane and nitrogen is challenging for any technology because these gases are similar in size, boiling point, and chemical nature. Conventional processes such as cryogenic distillation and pressure swing adsorption are in use but application of these technologies is not widespread because the costs of nitrogen removal from sub-quality gas increase the capital and operating costs of natural gas processing to a point at which the economics are too poor. Most plants that practice nitrogen rejection were built for dual use, such as production of helium and production of carbon dioxide for enhanced oil recovery (EOR) applications. In these cases, the costs of separating nitrogen are shared by a number of products, making the process feasible.

Once the hydrogen sulfide and carbon dioxide are processed to acceptable levels, the stream is routed to a nitrogen rejection unit (NRU), where it is further dehydrated using molecular sieve beds. In the nitrogen rejection unit, the gas stream is routed through a series of passes through a column and a brazed aluminum plate fin heat exchanger where the nitrogen is cryogenically separated and vented.

Another type of nitrogen rejection unit involves separation of methane and heavier hydrocarbons from nitrogen using an absorbent solvent. The absorbed methane and heavier hydrocarbons are flashed off from the solvent by reducing the pressure on the processing stream in multiple gas decompression steps. The liquid from the flash regeneration step is returned to the top of the methane absorber as lean solvent. Helium, if any, can be extracted from the gas stream through membrane diffusion in a pressure swing adsorption (PSA) unit.

Generally, nitrogen removal from natural gas requires liquefaction and fractionation of the entire gas stream, which may affect process economics. In many cases the nitrogen-containing natural gas is blended with a gas having a higher heating value and sold at a reduced price depending upon the thermal value (Btu/ft<sup>3</sup>). A membrane system can produce pipeline-quality gas and nitrogen-rich fuel from raw natural gas. The process relies on proprietary membranes that are significantly more permeable to hydrocarbons than to nitrogen (Table). In the membrane process, the gas dissolves at the contact surface of the membrane, permeates across the membrane under the partial pressure gradient across the membrane wall. The rate of permeation of gas  $A$  ( $q_A$ ) can be expressed as:

$$q_A = \frac{PM}{t} A_m \Delta P_A$$

In this equation,  $PM$  is the gas permeability in the membrane;  $A_m$  and  $t$  are the surface area and thickness of the membrane, respectively; and  $\Delta P_A$  is the partial pressure of gas  $A$  across the membrane.

In the process, gas containing 8 to 18% v/v nitrogen is compressed and passed across a first set of membrane modules. The permeate, which contains 4% nitrogen, is sent to the pipeline; the nitrogen-rich residue gas is passed to a second set of membrane modules. These modules produce a residue gas containing 50% nitrogen and a nitrogen-depleted permeate containing about 9% nitrogen. The residue gas is used as fuel; the permeate is mixed with the incoming feed gas for further recovery. The membrane process divides the gas into two streams. The first stream is product gas containing less than 4% nitrogen, which is sent to the pipeline; the second stream, which contains 30-50% nitrogen, is used to fuel the compressor engines. In some cases, a third stream is produced; this stream, which contains 60-85% nitrogen, is flared or reinjected.

In a typical two-step process, the feed gas containing 10 to 15% nitrogen is compressed to 800–1,200 psi using a gas-powered compressor. The gas then passes through the first set of methane-permeable membrane modules. The product gas, which contains 4% nitrogen, is sent to the pipeline. The residue is sent to a second set of modules but the permeate from these modules is too rich in nitrogen to be delivered

to the pipeline, and the gas is recirculated to the front of the compressor for further treatment. The residue gas from the second set of modules, which contains about 50% nitrogen, is used to fuel the compressor engines. The process achieves 80–90% recovery of the fuel gas Btu value in the pipeline product. Recovery values as high as 95% or higher can be achieved depending on the composition of the inlet gas.

**Table 1** Permeability of gases in various membranes\*.

Material	Temp., °C	He	H <sub>2</sub>	CH <sub>4</sub>	CO <sub>2</sub>	O <sub>2</sub>	N <sub>2</sub>
Silicone rubber	25	300	550	800	2700	500	250
Natural rubber	25	31	49	30	131	24	8.1
Polycarbonate (Lexane)	25–30	15	12		5.6,10	1.4	
Nylon 66	25	1			0.17	0.03	0.01
Polyester (Permasep)			1.7	0.04	0.31		0.03
Silicone-polycarbonate copolymer (57% silicone)	25		210		970	160	70
Teflon FEP	30	62		1.4			2.5
Ethyl cellulose	30	36	49	7.47	47.5	11.2	3.29
Polystyrene	30	41	56	2.72	23.3	7.47	2.55

\*Permeability = [cm<sup>3</sup>(STP) cm]/[s cm<sup>2</sup>/cm Hg] × 10<sup>10</sup>

## Gas Processing – Physical Solvent Processes

The physical solvent types of gas treatment are generally preferred when acid gases in the feed are above 50–60 psi. This indicates a combination of high pressure and high acid gas concentration. High molecular weight hydrocarbons in the feed discourage physical solvents, but not carbon sulfide (COS) and carbon disulfide (CS<sub>2</sub>), which do not degrade the solvents. Usually, physical solvents can remove carbon sulfide and carbon disulfide and mercaptans (RSH). Physical solvents are economical because regeneration occurs by flashing or stripping which require little energy.

The Selexol process uses the dimethyl ether of polyethylene glycol [CH<sub>3</sub>OCH(CH<sub>3</sub>)CH<sub>2</sub>OCH<sub>3</sub>] and the process can be designed to provide some selectivity for hydrogen sulfide. The Fluor solvent, propylene carbonate (a carbonate ester derived from propylene glycol, CH<sub>3</sub>CHOHCH<sub>2</sub>OH). This colorless and odorless liquid is useful as a polar, aprotic solvent), is used primarily for removal of carbon dioxide from high pressure gas streams.

Organic liquid (solvents) are used in physical solvent processes to absorb hydrogen sulfide (usually) preferentially over carbon dioxide at high pressure and low temperatures. Regeneration is carried out by releasing the pressure to the atmosphere and, on occasion, in vacuum with no heat. Henry's law is

$$P_i = HX_i$$

$$X_i = \frac{Y_i}{H} P$$

Thus, acid gas absorbed in liquid phase ( $X_i$ ) is proportional to its gas mole fraction ( $Y_i$ ) and inversely to Henry's constant (which is constant for a given temperature). Moreover, the solubility is proportional to the total gas pressure ( $P$ ) which means that at high pressure, acid gases will dissolve in solvents and, as the pressure, is released, the solvent can be regenerated.



# Gas Processing – Plant Schematic and Products

Gas treating (gas processing, gas refining) consists of separating all of the various hydrocarbons, non-hydrocarbons, and fluids from the pure natural gas (Table, Figure). Major transportation pipelines usually impose restrictions on the make-up of the natural gas that is allowed into the pipeline. That means that before the natural gas can be transported it must be purified. While the ethane, propane, butane, and pentanes must be removed from natural gas, this does not mean that they are all waste products. Gas processing is necessary to ensure that the natural gas intended for use is as clean and pure as possible, making it the clean burning and environmentally sound energy choice. Thus, natural gas, as it is used by consumers, is much different from the natural gas that is brought from underground up to the wellhead. Although the processing of natural gas is in many respects less complicated than the processing and refining of crude oil, it is equally as necessary before its use by end users. The natural gas used by consumers is composed almost entirely of methane. However, natural gas found at the wellhead, although still composed primarily of methane, is by no means as pure.

Raw natural gas comes from three types of wells: oil wells, gas wells, and condensate wells. Natural gas that comes from oil wells is typically termed *associated gas*. This gas can exist separate from oil in the formation (free gas), or dissolved in the crude oil (dissolved gas). Natural gas from gas and condensate wells, in which there is little or no crude oil, is termed *non-associated gas*. Gas wells typically produce raw natural gas by itself, while condensate wells produce free natural gas along with a semi-liquid hydrocarbon condensate. Whatever the source of the natural gas, once separated from crude oil (if present) it commonly exists in mixtures with other hydrocarbons; principally ethane, propane, butane, and pentanes. In addition, raw natural gas contains water vapor, hydrogen sulfide (H<sub>2</sub>S), carbon dioxide, helium, nitrogen, and other compounds. In fact, associated hydrocarbons, known as *natural gas liquids* (NGLs) can be very

valuable by-products of natural gas processing. Natural gas liquids include ethane, propane, butane, iso-butane, and natural gasoline that are sold separately and have a variety of different uses; including enhancing oil recovery in oil wells, providing raw materials for oil refineries or petrochemical plants, and as sources of energy.

**Table 1** Components of natural gas.

Component	Chemical formula	Boiling Point
Methane	CH <sub>4</sub>	-161.6 °C
Ethane	C <sub>2</sub> H <sub>6</sub>	-88.6 °C
Propane	C <sub>3</sub> H <sub>8</sub>	-42.1 °C
Butane	n-C <sub>4</sub> H <sub>10</sub>	-0.5 °C
Higher m. wt. HCs		
Alkenes	C <sub>n</sub> H <sub>2n</sub>	
Aromatics	C <sub>6</sub> H <sub>6</sub> plus	
Acid Gases		
Carbon Dioxide	CO <sub>2</sub>	-78 °C
Hydrogen Sulfide	H <sub>2</sub> S	-60.2 °C
Mercaptans		
Methanethiol	CH <sub>3</sub> SH	5.95 °C
Ethanethiol	C <sub>2</sub> H <sub>5</sub> SH	35 °C
Other Gases		
Nitrogen	N <sub>2</sub>	-195.79 °C
Helium	He	-268.93 °C
Water	H <sub>2</sub> O	0 °C
Trace pollutants		
Mercury		
Various chlorides		

**Table 2** Characterization of natural gas.

<b>Wet gas</b>	Raw gas with a methane content of less than 85% v/v methane
<b>Dry gas</b>	Raw or treated natural gas that contains less than 0.1 gallon per 1000 scf (15 liters 1000 m <sup>3</sup> ) of condensate.
<b>Sour gas</b>	Raw gas with a content of more than 0.25 mg (ca. 4 ppm) hydrogen sulfide (5.7 mg m <sup>3</sup> ).
<b>Acid gas</b>	A high content of acidic gases such as carbon dioxide or hydrogen sulfide; pipeline natural gas specification is typically less than 2% v/v carbon dioxide; the typical range for sour gas is 10 to 40% v/v.
<b>Condensate</b>	A mixture of higher molecular weight hydrocarbons; typically, a gas from the well that condenses out as liquid during the production process.

**Table 3** Product of gas processing.

<b>Natural gas</b>	A specific composition of hydrocarbons with a specified energy content; typically, 90%+ v/v methane.
<b>Natural gas liquids (NGL)</b>	A processed purified product consisting of ethane, propane, butane or some higher alkanes separately, or in a blend; primarily a raw material for the petrochemical industry, it is often processed from the condensate.
<b>Liquefied petroleum gas (LPG)</b>	Propane or butane or a mixture of these that has been compressed to liquid at room temperature; used for consumer domestic use as fuel, and is also used as aerosol propellant (in spray cans) and refrigerant.
<b>Liquefied natural gas (LNG)</b>	Gas that is refrigerated and liquefied at below -162 °C, for storage and transport; takes up 1/600 of the volume of the gas at room temperature; after transport and storage it is reheated/vaporized and compressed for pipeline transport.
<b>Compressed natural gas (CNG)</b>	Natural gas that is compressed to less than 1% of the volume at atmospheric pressure; methane cannot be kept liquid by high pressure at normal ambient temperatures because of a low critical temperature.

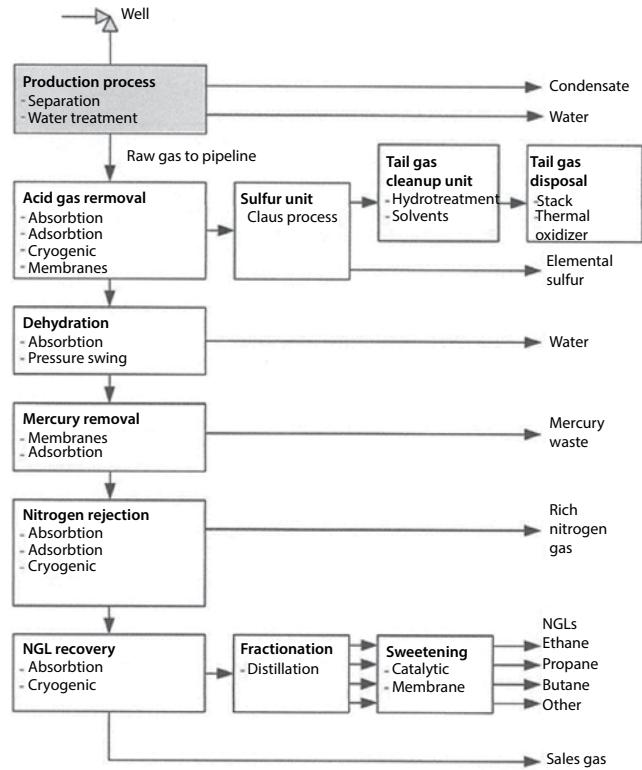

**Figure** Schematic of a gas processing plant.



## Gas Processing – Processes and Process Selection

Gas treating (*gas processing, gas refining*) consists of separating all of the various hydrocarbons, non-hydrocarbons (in addition to carbon dioxide and hydrogen sulfide), and fluids from the methane (Table). The processes are necessary to ensure that the natural gas intended for use is clean-burning and environmentally acceptable. Natural gas used by consumers is composed almost entirely of methane but natural gas that emerges from the reservoir at the wellhead is by no means as *pure*. Although the processing of natural gas is in many respects less complicated than the processing and refining of crude oil, it is equally as necessary before its use by end users.

The actual practice of processing natural gas to high-quality pipeline gas for the consumer usually involves five main processes to remove the various impurities: (1) water removal, (2) liquids removal, (3) enrichment, (4) fractionation, and (5) the process by which hydrogen sulfide is converted to sulfur (the *Claus process*).

The processes that have been developed to accomplish gas purification vary from a simple once-through wash operation to complex multi-step recycling systems. In many cases, the process complexities arise because of the need for recovery of the materials used to remove the contaminants or even recovery of the contaminants in the original, or altered. However, the processes applied to gas processing are subject to several variables that must, of necessity, be considered: (1) the types of contaminants in the gas, (2) the concentrations of contaminants in the gas, (3) the degree of contaminant removal desired, (4) the selectivity of acid gas removal required, (5) the temperature of the gas to be processed, (6) the pressure of the gas to be processed, (7) the volume of the gas to be processed, (8) the composition of the

gas to be processed, (9) the carbon dioxide-hydrogen sulfide ratio in the gas and (10) the desirability of sulfur recovery due to process economics or environmental issues.

Process selectivity indicates the preference with which the process removes one acid gas component relative to (or in preference to) another. For example, some processes remove both hydrogen sulfide and carbon dioxide while other processes are designed to remove hydrogen sulfide only. It is important to consider the process selectivity for, say, hydrogen sulfide removal compared to carbon dioxide removal that ensures minimal concentrations of these components in the product, thus the need for consideration of the carbon dioxide to hydrogen sulfide ratio in the gas stream.

Each of the treating processes has advantages relative to the others for certain applications; therefore, in selection of the appropriate process, the following facts should be considered: (1) tail gas cleanup requirements, (2) type and concentration of impurities in the sour gas, (3) specifications for the residue gas, (4) specifications for the acid gas, (5) temperature and pressure at which the sour gas is available and at which the sweet gas must be delivered, (6) volume of gas to be processed, (7) hydrocarbon composition of the gas, and (8) selectivity required for acid gas removal.

Decisions in selecting a gas treating process can many times be simplified by gas composition and operating conditions. High partial pressures (50 psi) of acid gases enhance the probability of using a physical solvent. The presence of significant quantities of heavy hydrocarbons in the feed discourages using physical solvents. Low partial pressures of acid gases and low outlet specifications generally require the use of amines for adequate treating.

**Table** Range of composition of natural gas.

Methane	CH <sub>4</sub>	70–90%
Ethane	C <sub>2</sub> H <sub>6</sub>	0–20%
Propane	C <sub>3</sub> H <sub>8</sub>	
Butane	C <sub>4</sub> H <sub>10</sub>	
Pentane and higher hydrocarbons	C <sub>5</sub> H <sub>12</sub>	
Carbon Dioxide	CO <sub>2</sub>	0–8%
Oxygen	O <sub>2</sub>	0–0.2%
Nitrogen	N <sub>2</sub>	0–5%
Hydrogen sulfide, carbonyl sulfide	H <sub>2</sub> S, COS	0–5%
Rare gases: Argon, Helium, Neon, Xenon	A, He, Ne, Xe	Trace

**Table 2** Gas treating processes (listed alphabetically).

<b>Process</b>	<b>ADIP</b>
<b>Application</b>	The regenerative amine process removes hydrogen sulfide and carbon dioxide from natural gas, refinery gas and synthesis gas. Hydrogen sulfide can be reduced to low sulfur levels. The process can also be applied to remove H <sub>2</sub> S, CO <sub>2</sub> and carbonyl sulfide from liquefied petroleum gas or natural gas liquid to low levels.
<b>Description</b>	The process uses aqueous solutions of the secondary amine, di-isopropanolamine or the tertiary amine, methyl di-ethanolamine. Amine concentrations up to 50% w/w can be applied.
<b>Conditions</b>	A very wide range of treating pressures and contaminant concentrations can be accommodated.
<b>Licensors</b>	Shell Global Solutions International B.V.
<b>Process</b>	<b>ADIP-X</b>
<b>Application</b>	This regenerative amine process is highly suitable for bulk and deep CO <sub>2</sub> removal from gas streams.
<b>Description</b>	The process uses aqueous solutions of the tertiary amine, methyl diethanolamine and additive. High integration of separate process units is possible.
<b>Conditions</b>	A very wide range of treating pressures and contaminant concentrations can be accommodated. Bulk CO <sub>2</sub> removal from a high percentage to several percentage points is easily attained.
<b>Licensors</b>	Shell Global Solutions International BV
<b>Process</b>	<b>Amine Guard FS</b>
<b>Application</b>	Remove CO <sub>2</sub> , H <sub>2</sub> S, COS and RSH from natural gas, CO <sub>2</sub> from ammonia syngas, etc., with a solution containing one of the Varsol family of formulated solvents.
<b>Description</b>	The treating solutions scrubs acid gas from the feed in an absorber column. The rich solution is regenerated by reducing its pressure and stripping with steam in the stripper tower. Waste heat is commonly used to provide the steam.
<b>Conditions</b>	Absorption pressure is atmosphere to 2,000 psi, as available. Feed temp. 85 °F–150 °F, acid gas content may be up to 50%.
<b>Licensors</b>	UOP LLC
<b>Process</b>	<b>Benfield</b>
<b>Application</b>	Removal of CO <sub>2</sub> , H <sub>2</sub> S, COS and RSH from natural gas or SNG.
<b>Description</b>	Acid gases are scrubbed from the feed in an absorber column (1) using potassium carbonate solution with Benfield additives to improve performance and avoid corrosion. (2) Waste heat is commonly used to provide the steam.
<b>Conditions</b>	Absorption pressure-50 to 2000 psi, Feed temp. - 150–250 °F, Acid gas content - 50%.
<b>Licensors</b>	UOP LLC

Table 2 Cont.

<b>Process</b>	<b>CO<sub>2</sub> removal - LRS 10</b>
<b>Application</b>	Remove CO <sub>2</sub> from natural gas, SNG or ammonia syngas.
<b>Description</b>	Rich CO <sub>2</sub> feed gas is passed to the absorber column containing potassium carbonate solution and LRS10 additives. Feed gas containing about 20% CO <sub>2</sub> has been treated successfully, typically to CO <sub>2</sub> levels of 1% in the processed gas, depending on process arrangement. Process configuration changes can lower CO <sub>2</sub> slippage levels from 500 ppm to 1000 ppm in some designs.
<b>Conditions</b>	Reduce CO <sub>2</sub> slippage in the outlet gas - 50% Improve column operations by moving away from column constraints.
<b>Licensor</b>	Avantika Technologies Ltd.
<b>Process</b>	<b>CO<sub>2</sub> Removal-Molecular Gate</b>
<b>Application</b>	Simultaneously removes CO <sub>2</sub> and water from contaminated natural gas. Feedstocks include coalbed methane and natural gas. Water saturated feeds and CO <sub>2</sub> levels of 3–40% can be treated. Product is pipeline-quality natural gas with characteristic CO <sub>2</sub> levels of less than 2%. The process uses a specially adsorption for CO <sub>2</sub> removal in a patent-pending, proprietary, pressure adsorption (PSA) system.
<b>Description</b>	Water saturated feed at pressure levels between 100 and 800 psig, is routed through a series of adsorber vessels. Between three and eight adsorber vessels are used.
<b>Conditions</b>	Modular construction allows low-cost installation and equipment relocation flexibility.
<b>Licensor</b>	Engelhard Corp.
<b>Process</b>	<b>IRON SPONGE</b>
<b>Application</b>	To remove H <sub>2</sub> S and mercaptans from natural gas streams at low or high pressure conditions at or near the wellhead.
<b>Description</b>	Iron sponge (iron oxidized onto wood shavings) uses a simple packed tower on a flow-through support. After liquid separation the deflected sour gas flows down to contact with the reactive iron oxide, simply and effectively converting H <sub>2</sub> S into a solid. An excess of water is tolerated very well by iron sponge as long as the excess is drained off, so as not to flood the bed.
<b>Conditions</b>	The maximum temperature should not exceed 120 °F, minimum of 50 °F, avoid hydrate formation for the system pressure and composition of the gas. Minimum operating time is required.
<b>Licensor</b>	Connelly-GPM, Inc.
<b>Process</b>	<b>PURASPEC</b>
<b>Application</b>	Removal of ppm concentrations of H <sub>2</sub> S, COS and ppb levels of mercury from hydrocarbon gases/ liquids to meet pipeline or petrochemical specifications.
<b>Description</b>	Fixed beds of chemical absorbents provide effectively total irreversible selective removal of impurities from wet or dry hydrocarbons without feedstock losses. Radial flow reactor designs are available if low system pressure drop is required.
<b>Conditions</b>	Temperature - 20–400 °F, Pressure – Atmospheric to 2000 psi.
<b>Licensor</b>	Synetix
<b>Process</b>	<b>Purisol</b>
<b>Application</b>	Removal of acid gases from natural gas, fuel gas and syngas by physical absorption in NMP (N-methyl-2-pyrrolidone). High CO <sub>2</sub> contents to low residual level, Bulk acid gas removal to moderate purity by simple flash regeneration, Selective H <sub>2</sub> S removal. Ideally suited for IGCC based on POX of coal or oil, an NMP, is the most selective solvent on the market. It is a cheap, stable, noncorrosive and easily available solvent with a broad range of further industrial applications.
<b>Description</b>	Raw gas from a POX of heavy residue is cooled: HCN and organic sulfur compounds are removed in prewash, H <sub>2</sub> S is removed in main absorber by hot regenerated, lean solvent cooled slightly below ambient temperature. NMP traces are backwashed on top of with H <sub>2</sub> O.

(Continued)

Table 2 Cont.

<b>Conditions</b>	
<b>Installations</b>	7 units in operation or under construction
<b>References</b>	Hydrocarbon processing 2002 /MAY 2002
<b>Licensor</b>	Lurgi Oel-Gas-Chemie GmbH
<b>Process</b>	<b>Rectisol</b>
<b>Application</b>	Acid gas removal using an organic solvent at low temperatures. In general, methanol is used for H <sub>2</sub> S, COS and CO <sub>2</sub> removal, whereby organic and inorganic impurities are also removed. It is possible to produce a clean gas with less than 0.1 ppm sulfur and a CO <sub>2</sub> content down to the ppm range. The main advantage over other processes is the use of a cheap, stable and easily available solvent, a very flexible process and low utilities.
<b>Description</b>	Rectisol unit for the selective desulfurization and CO <sub>2</sub> removal in the production of methanol synthesis gas. Raw gas from SGP-POX is cooled and trace components are removed in the prewash with cold methanol. Prewashed gas is desulfurized by using CO <sub>2</sub> laden solvent down to 0.1 ppm. H <sub>2</sub> S laden solvent is regenerated first by flashing to medium pressure to recover H <sub>2</sub> and CO <sub>2</sub> and second, by heating to boiling temperature and stripping with methanol vapors. The stripped H <sub>2</sub> S enriched gases are sent to a Claus unit. The portion of the desulfurized gas which has been shifted in the CO shift conversion unit has a typical CO <sub>2</sub> content of 33%. Shifted gas reenters the Rectisol unit, is cooled and the CO <sub>2</sub> is removed in a two stage absorber.
<b>Conditions</b>	
<b>Licensor</b>	Lurgi Oel-Gas-Chemie GmbH Linde AG
<b>Process</b>	<b>Selexol</b>
<b>Application</b>	Selectively remove H <sub>2</sub> S and COS in integrated gasification combined cycle (IGCC) with high CO <sub>2</sub> rejection to product gas 85% and high sulfur 25% to 80% feed to the Claus unit. Selectively remove H <sub>2</sub> S/COS plus bulk removal of CO <sub>2</sub> in gasification for high-purity H <sub>2</sub> generation for refinery or fertilizer applications, and treat natural gas to achieve either LNG or pipeline specification with dew-point reduction.
<b>Description</b>	This process uses Dow's Selexol solvent a physical solvent made of a dimethyl ether of polyethylene glycol, which is chemically inert and not subject to degradation. The process also removes COS, mercaptans, ammonia, HCN and metal carbonyls. A variety of flow schemes permit process optimization and energy reduction. Carbon steel can be used for the materials of construction of equipment and piping due to the process non-aqueous nature and inert chemical characteristics. Acid gas partial pressure is the key driving force. Typical feed conditions range between 300 and 2000 psia, with acid composition (CO <sub>2</sub> + H <sub>2</sub> S) from 5% to more than 60% v/v. The product specifications achievable depend on the application and can range from ppm up to percent levels of acid gas.
<b>Conditions</b>	
<b>Licensor</b>	UOP LLC
<b>Process</b>	<b>SulfaClean-HC-Liquid Sweetening</b>
<b>Application</b>	SulfaClean HC is a granular material that is used to remove aggressive sulfur compounds, primarily hydrogen sulfide (H <sub>2</sub> S), in a variety of clear liquid streams. Propane/propylene, butane, LNG, NGL, gasoline and other light liquid hydrocarbon streams treatment reduces corrosion to pass copper strip testing and meet H <sub>2</sub> S limits. Dry or water saturated liquid hydrocarbons can be treated, as well as water or brines for removal of dissolved H <sub>2</sub> S prior to disposal.
<b>Description</b>	Liquids flow upward through the SulfaClean-HC media. Flow rates and system design depend on fluid type and contaminants quantity. Systems range from single vessels or multiple parallel flow to lead/lag style applications. A properly designed system can be adapted to variable flow rates without loss in treating efficiencies.
<b>Conditions</b>	
<b>Licensor</b>	Sulfa Treat, a Division of M-ILLC
<b>Process</b>	<b>SulfaTreat-Gas or Air H<sub>2</sub>S Removal</b>
<b>Application</b>	Various SulfaTreat processes treat contaminated gas and air with a granular media that selectively removes hydrogen sulfide (H <sub>2</sub> S) and some light mercaptans.

Table 2 Cont.

<b>Description</b>	Gas or vapor flows through the media, reacting with H <sub>2</sub> S forming a stable and environmentally compliant byproduct at any point in its life cycle. Product consumption is not adversely affected by other gas components. The media prefers high humidity levels to fully water-saturate gas. Computer assisted design matches operating conditions with desired results, such as maximum outlet allowed pressure drops and long bed life. It works in any gas pressure or vacuum, inlet H <sub>2</sub> S concentration and at temperatures up to 300 °F. System sizes range from removing a few pounds up to over a tone H <sub>2</sub> S daily, and to as low as 0.1-ppm maximum outlet, depending on system design.
<b>Conditions</b>	
<b>Licensor</b>	Sulfa Treat, a division of M-1LLC
<b>Process</b>	<b>Sulfinol</b>
<b>Application</b>	Removal of H <sub>2</sub> S, COS, RSH, other organic sulfur compounds and all or part of the CO <sub>2</sub> from natural, synthetic and refinery gases. Total sulfur compounds in the treated gas can be reduced to ultra-low ppm levels, as required for refinery-fuel and pipeline quality gases. An improved application is to selectively remove H <sub>2</sub> S, COS, RSH and other organic sulfur compounds for pipeline specification, while co-absorbing only part of the CO <sub>2</sub> . Deep CO <sub>2</sub> removal for LNG plants is another application, as well as bulk CO <sub>2</sub> removal with flash regeneration of the solvent. The process sequence-Sulfinol/Claus/ SCOT can be used advantageously with an integrated Sulfinol system that handles selective H <sub>2</sub> S removal upstream and the SCOT process that treats the Claus off gas.
<b>Description</b>	The mixed solvent consists of a chemical-reacting alkanolamine, water and physical solvent sulfolane (tetrahydrothiophene dioxide). The actual chemical formulation is customized for each application. Unlike aqueous amine processes, Sulfinol removes COS, RSH and other organic sulfur compounds to stringent total sulfur specifications. The process achieves 4 ppm H <sub>2</sub> S pipeline specification at low stream consumption. Observed corrosion rates are low and little foaming is experienced. The system line-up resembles from the absorber are flashed from the solvent and used as fuel gas after treatment in a fuel gas absorber. Loaded solvent is regenerated.
<b>Conditions</b>	Very wide ranges of treating pressures and contaminant concentrations can be accommodated. Refinery fuel gas and gas pipeline specifications, such as 40 ppm v/v total sulfur and 100 ppm v/v H <sub>2</sub> S, are readily met. Removal of organic sulfur compounds is usually done for the circulation set by H <sub>2</sub> S and CO <sub>2</sub> removal. In LNG plants, a 50 ppm v/v CO <sub>2</sub> specification can be attained.
<b>Licensor</b>	Shell Global Solution International B.V.
<b>Process</b>	<b>CO<sub>2</sub> Recovery</b>
<b>Application</b>	Recover high purity including food grade, CO <sub>2</sub> from oxygen containing gases such as boiler flue gases, gas turbine exhausts and waste gases using Kerr-McGee/ABB Lummus Global absorption/stripping technology.
<b>Description</b>	CO <sub>2</sub> containing feed gas are first cooled and scrubbed, if necessary, to reduce SO <sub>2</sub> levels. The gases are boosted slightly in pressure before entering the recovery system. The system is based on absorption/ stripping using a 15% to 20% monoethanolamine (MEA) solution. Feed gases are sent to an amine absorber where they are scrubbed with MEA to recover CO <sub>2</sub> . The scrubbed gases are vented to the atmosphere after water washing in the absorbers top to minimize MEA losses. Rich solution from the MEA absorber is preheated in an exchanger, flashed and sent to stripper where CO <sub>2</sub> is recovered overhead. Condensate from the stripper overhead is returned to the system. Lean MEA from the stripper is cooled, filtered and returned to the absorber. Periodically, a batch reclaiming operation is conducted to purge MEA degradation products and to recover MEA by decomposing heat stable salts. The bottoms from the reclaiming operation may be burned as boiler fuel. CO <sub>2</sub> recovered from the stripper overhead may be compressed and used as a vapor product, or dried and liquefied using a standard ammonia refrigeration system to produce a liquid product.
<b>Conditions</b>	Operating units have exhibited availability factors in excess of 98%. Absorption and stripping operations take place at slightly above atmospheric pressure. Feed gas can contain up to 15% v/v oxygen, though process efficiency is favored by high CO <sub>2</sub> and low oxygen concentrations in the feed. The process can recover CO <sub>2</sub> from flue gases containing from 3 to 15% v/v (dry basis) CO <sub>2</sub> . Moderate levels of SO <sub>2</sub> and NO <sub>x</sub> in the feed are acceptable. SO <sub>2</sub> pre-scrubbing is required only with SO <sub>2</sub> levels higher than 100 ppm v/v.
<b>Licensor</b>	ABB Lummus Global Inc.
<b>Process</b>	<b>THIOLEX/REGEN</b>
<b>Application</b>	Extract H <sub>2</sub> S, COS and mercaptans from gases and high liquid streams, including gasoline, with caustic using FIBER-FILM contactor technology. It can be used to hydrolyze COS contained in LPG.

(Continued)

Table 2 Cont.

<b>Description</b>	The caustic phase flows along the FIBER-FILM contactor fibers, which is continuously renewed, as the wet fibers are preferentially wetted by the caustic phase in the THIOLEX process. Hydrocarbons flow through the shroud parallel to the caustic phase where the H <sub>2</sub> S and mercaptans are extracted into the caustic phase. The two phases disengage and the caustic flows to the REGEN system. The spent caustic is regenerated using air and catalyst in the oxidizer for reuse, which converts the extracted mercaptan derivatives to disulfide derivatives. The disulfide derivatives are removed from the caustic by a FIBER-FILM contactor solvent wash system.
<b>Conditions</b>	FIBER-FILM contactor technology requires smaller processing vessels, allowing shorter separation times and less waste generation.
<b>Licensor</b>	Merichem Chemicals & Refinery Services LLC
<b>Process</b>	<b>AMINEX</b>
<b>Application</b>	Extract H <sub>2</sub> S, COS and CO <sub>2</sub> from gases and light liquid streams with amine solution using FIBER-FILM contactor technology.
<b>Description</b>	The amine flows along the FIBER-FILM contactor fibers, which are continuously renewed, as the wet fibers are preferentially wetted by the amine phase in the AMINEX process. Hydrocarbons flow through the shroud parallel to the amine-wetted fibers where the H <sub>2</sub> S, COS, and/or CO <sub>2</sub> are extracted into the amine phase. The two phases disengage in the separator vessel where the rich amine flows to the amine regeneration unit and the treated gas or light liquids goes to storage.
<b>Conditions</b>	FIBER-FILM contactor technology requires smaller processing vessels allowing shorter separation times and less waste generation.
<b>Licensor</b>	Merichem Chemicals & Refinery Services LLC
<b>Process</b>	<b>Sulfur Degassing</b>
<b>Application</b>	Remove H <sub>2</sub> S and H <sub>2</sub> Sx dissolved in liquor sulfur.
<b>Description</b>	Liquid sulfur flowing from the Claus plant to the sulfur pit contains typically 250–350 ppm v/v of H <sub>2</sub> S + H <sub>2</sub> Sx. Sulfur is degassed using an active gas liquid contacting system to release dissolved gas. Adding chemicals is not required. Sulfur from the pit is pumped into the degassing tower where it is contacted counter-currently with hot compressed air over a fixed catalyst bed. Degassed sulfur is returned to the product section of the sulfur pit.
<b>Conditions</b>	The operating temperature in the sulfur degassing tower can vary from 125 °C to 150 °C depending on the temperature in the sulfur pit. The operating pressure drop is around 0.3–0.5 bar. Treated sulfur has a residual H <sub>2</sub> S level in the range of 5–10 ppm v/v.
<b>Licensor</b>	AMOCO through SHRTEC NIGL
<b>Process</b>	<b>AMMOGEN</b>
<b>Application</b>	AMMOGEN provides gaseous ammonia to fossil-fuel-burning plants to operate pollution control systems such as DeNO <sub>x</sub> /DeSO <sub>x</sub> SCR, SNCR and flue gas treatment units. This process produces gaseous ammonia onsite and on demand with harmless and easy to handle feedstocks. It eliminates the hazard of transporting and storing toxic compounds such as anhydrous or aqueous ammonia.
<b>Description</b>	Main advantages include: Gaseous ammonia produced onsite and on demand utmost safety urea feedstock is harmless, easy to handle and widely available simple and safe non-catalytic process no carryover of compounds that can damage SCR system very rapid response time and maximum turndown availability quick startup, shutdown and standby automatic operation and low maintenance limited plant footprint for easier installation, also can be skid-mounted or module low capital and operating cost capacity from several to thousands kg/h of ammonia.
<b>Licensor</b>	SIIRTEC NIGI and HERA
<b>Process</b>	<b>Clauspol</b>
<b>Application</b>	Claus tail gas treatment with total sulfur recoveries up to 99.94%. Liquid phase conversion of H <sub>2</sub> S and SO <sub>2</sub> into liquid elemental sulfur (S).

Table 2 Cont.

<b>Description</b>	Claus tail gas is contacted counter-currently with an organic solvent in a low pressure drop packed column. Hydrogen sulfide and SO <sub>2</sub> are absorbed in the solvent and react to form liquid elemental S according to the Claus reaction, which is promoted by an inexpensive dissolved catalyst. The solvent is pumped around the contactor, and the heat of reaction is removed through a heat exchanger to maintain a constant temperature slightly above the sulfur melting point. Due to the limited solubility of S in the solvent, pure liquid S separates from the solvent and is recovered from settling section at the bottom of the contactor. This standard Clauspol II flow scheme allows S recovery up to 99.8% w/w. The recovery level can be customized by adapting the size of the contactor.
<b>Licensor</b>	Prosernat IFP Group Technologies
<b>Process</b>	<b>BioDeNOx</b>
<b>Application</b>	The BioDeNOx biological process removes NOx from flue gases. Iron chelate selectively absorbs NOx, the NOx is reduced to nitrogen with ethanol in the presence of microorganisms.
<b>Description</b>	The BioDeNOx system uses a wet gas scrubber to contact the circulation liquid with flue gas feed and absorb the NOx. In the sump underneath the scrubber, the absorbed NOx is biologically reduced to nitrogen and ethanol is also consumed. Thus, the iron chelate solution is regenerated. The presence of oxygen and acids compounds in the flue gas, such as HCl and HE, oxidizes a part of iron chelate to ferric state. Therefore, a purge and makeup of iron chelate is necessary to eliminate this oxidized ferric material. To minimize consumption of the iron chelate, a nano-filtration is installed. Bleed from the unit is passed through the filter and the chelate is recovered.
<b>Conditions</b>	The scrubber and the sump operate close to the atmospheric pressure and 60–70 °C.
<b>Licensor</b>	UOP LLC and BioStar B.V.
<b>Process</b>	<b>THIOPAQ</b>
<b>Application</b>	Biological desulfurization of high pressure natural gas, synthesis gas, fuel gas streams, acid gas from amine regeneration and treatment of spent caustic. The two processes are based on the same principle, but marketed under the name Shell Paque when high pressure natural gas, synthesis gas and Claus tail gas are treated, for all other applications, the name Thiopaq is used.
<b>Description</b>	In the Thiopaq process H <sub>2</sub> S directly oxidized to elemental sulfur (S) using colorless sulfur bacteria (Thiobacilli). These naturally occurring bacteria are not genetically modified. Feed gas is sent to a caustic scrubber in which the H <sub>2</sub> S reacts to sulfide. The sulfide is converted to elemental S and caustic by the bacteria when air is supplied in the bioreactor. Sulfur particles are covered with a (bio) macropolymer layer, which keeps the sulfur in a milk like suspension that does not cause fouling or plugging. In this process a sulfur slurry is produced, which can be concentrated to a cake containing 60 °C dry matter. This cake can be used directly for agricultural purposes, or as feedstock for sulfuric acid manufacturing. Alternately, the biological sulfur slurry can be purified further by melting to high-quality sulfur to meet international Claus sulfur specifications.
<b>Licensor</b>	Shell Paques, Paques B.V. and Shell Global Solutions International
<b>Process</b>	<b>Thiopaq DeSOx</b>
<b>Application</b>	The Thiopaq DeSOx biological process selectively removes and converts SOx in the flue gases to elemental sulfur or H <sub>2</sub> S.
<b>Description</b>	The Thiopaq DeSOx is a commercial, two step biological process. It can convert sulfite and sulfate to elemental sulfur. A sodium biophosphate solution quenches and removes particulates and absorbs SOx from the flue gas. The scrubbing liquid is regenerated and recycled to the scrubber. The heart of the Thiopaq process is the proprietary anaerobic and aerobic bioreactors. In these airlift loop reactors, the absorbed sulfite is reduced to sulfide (HS) inside the anaerobic reactor in the presence of microorganism with hydrogen. The sulfide is then oxidized under controlled conditions to elemental sulfur via the microorganisms. The produced elemental sulfur has a hydrophilic nature and is separated from the aqueous effluent in a proprietary three-phase separator.
<b>Conditions</b>	The scrubber operates close to the atmospheric pressure and at saturation of the scrubbing liquid. The anaerobic bioreactor can be operated at pressures of up to 6 bar and 60–70 °C. The aerobic bioreactor operates at atmospheric pressure and 30–35 °C.
<b>Licensor</b>	UOP LLC, Monsanto Environchem System Inc., Paques Bio System

(Continued)

Table 2 Cont.

<b>Process</b>	<b>Thiopaq: H<sub>2</sub>S removal</b>
<b>Application</b>	The biological Thiopaq process selectively removes and converts H <sub>2</sub> S and light mercaptans from gas streams, aqueous streams and/or light hydrocarbons to elemental sulfur or sulfate.
<b>Description</b>	The Thiopaq process consists of three integrated process sections. An absorption section to remove the H <sub>2</sub> S from the gas stream, bioreactors and a sulfur separation section. The heart of this process is the proprietary bioreactor. In this air lift loop reactors, sulfide is oxidized under controlled conditions to elemental sulfur in the presence of microorganisms. These aerobic organisms use the released energy from the sulfide oxidation for metabolic processes. The elemental sulfur produced has a hydrophilic nature and is separated from the aqueous effluent in a proprietary three phase separator. The scrubbing step to remove H <sub>2</sub> S from the gas streams is integrated into the Thiopaq process and regenerates the scrubbing solution, rather than its disposal. Regeneration is possible because the alkalinity consumption due to the absorption of H <sub>2</sub> S is compensated by the oxidation of H <sub>2</sub> S to elemental sulfur.
<b>Conditions</b>	The absorber operates at the pressure of feed and a bioreactor temperature. The bioreactor operates at atmospheric pressure and 30–35 °C. If the feed is available at a higher temperature, it requires cooling before entering the absorber.
<b>Licensor</b>	UOP LLC, Shell International Oil Products BV, Paques Bio System B.V.

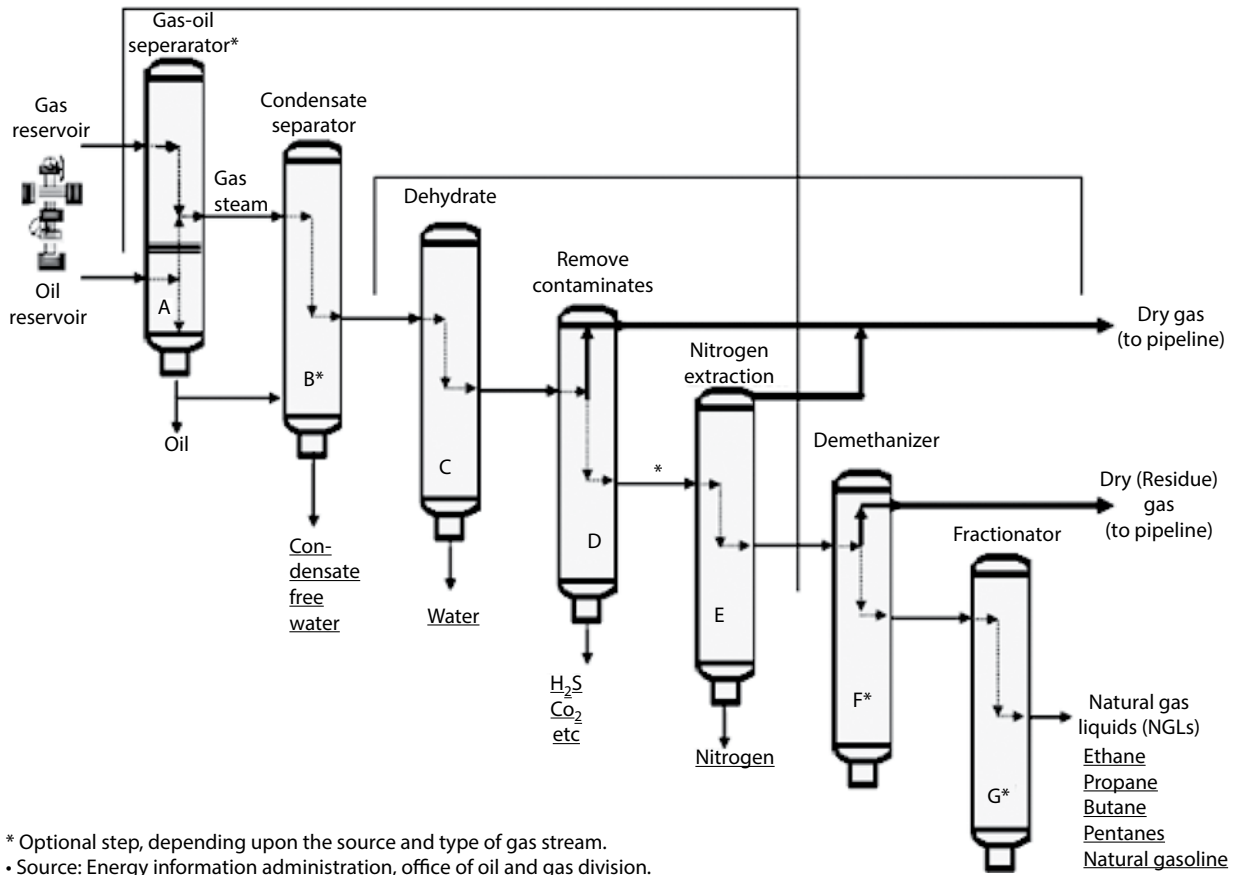
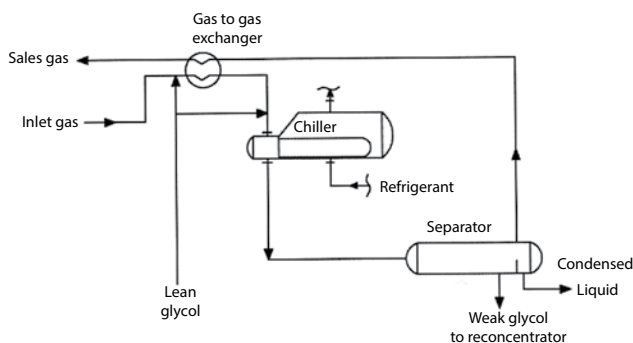

Figure Gas treating.



# Gas Processing – Water Removal

Water is a common impurity in gas streams, and removal of water is necessary to prevent condensation of the water and the formation of ice or gas hydrates ( $C_n H_{2n+2} \cdot xH_2O$ ). Water in the liquid phase causes corrosion problems in pipelines and equipment, particularly when carbon dioxide and hydrogen sulfide are present in the gas. The simplest method of water removal (refrigeration or cryogenic separation) is to cool the gas to a temperature at least equal to or (preferentially) below the dew point (Figure). Most of the water associated with natural gas is removed by simple separation methods



**Figure** The refrigeration process using glycol.

at or near the wellhead. However, the removal of the water vapor that exists in solution in natural gas requires a more complex treatment. This treatment consists of *dehydrating* the natural gas, which usually involves one of two processes: either absorption, or adsorption.

A dehydration process is needed to eliminate water which may cause the formation of hydrates and can be accomplished by several methods. Among these is the use of ethylene glycol (glycol injection) systems as an absorption process. The process removes water and other solids from the gas stream. Alternatively, adsorption dehydration may be used, utilizing dry-bed dehydrators towers, which contain desiccants such as silica gel and activated alumina, to perform the extraction (Table).

In a majority of cases, cooling alone is insufficient and, for the most part, impractical for use in field operations. Other water removal processes use (1) *hygroscopic* liquids (e.g., diethylene glycol or triethylene glycol) and (2) solid adsorbents or desiccants (e.g., alumina, silica gel, and molecular sieves). Ethylene glycol can be directly injected into the gas stream in refrigeration plants.

The glycol has a chemical affinity for water and removes water from the gas stream. In this process, a liquid desiccant dehydrator serves to absorb water vapor from the gas stream.

**Table** Properties of solid desiccants.

Desiccant	Silica Gel	Activated alumina	Molecular sieve
Pore diameter (Angstrom units)	10 to 90	15	3,4,5,10
Bulk density (lb/ft <sup>3</sup> )	45	44–48	43–47
Heat capacity (Btu/lb °F)	0.22	0.24	0.23
Minimum dew point (°F)	–60 to –90	–60 to –90	–100 to –300
Design capacity (wt %)	4–20	11–15	8–16
Regeneration stream temperature, °F	300–500	350–500	425–550
Heat of adsorption (Btu/lb)			1800

Essentially, glycol dehydration involves using a glycol solution, usually either diethylene glycol (DEG) or triethylene glycol (TEG), which is brought into contact with the wet gas stream in a *contactor*. The glycol solution will absorb water from the wet gas and, once absorbed, the glycol particles become heavier and sink to the bottom of the contactor where they are removed. The natural gas, having been stripped of most of its water content, is then transported out of the dehydrator. The glycol solution, bearing all of the water stripped from the natural gas, is put through a specialized boiler designed to vaporize only the water out of the solution. The boiling point differential between water (100 °C, 212 °F) and glycol (204 °C, 400 °F) makes it relatively easy to remove water from the glycol solution, allowing it be reused in the dehydration process.

In addition to losing a portion of the natural gas that was extracted, this venting contributes to air pollution and the greenhouse effect. In order to decrease the amount of methane and other compounds that are lost, flash tank separator-condensers work to remove these compounds before the glycol solution reaches the boiler. Essentially, a flash tank separator consists of a device that reduces the pressure of the glycol solution stream, allowing the methane and other hydrocarbons to vaporize (*flash*). The glycol solution then travels to the boiler, which may also be fitted with air or water cooled condensers, which serve to capture any remaining organic compounds that may remain in the glycol solution. The regeneration (stripping) of the glycol is limited by temperature: diethylene glycol and triethylene glycol decompose at or before their respective boiling points. Such techniques as stripping of hot triethylene glycol with dry gas (e.g., heavy hydrocarbon vapors, the *Drizo process*) or vacuum distillation are recommended.

Water may be removed from gas streams at the same time as hydrogen sulfide is removed. Moisture removal is necessary to prevent harm to anhydrous catalysts and to prevent the formation of hydrocarbon hydrates (e.g.,  $C_3H_8 \cdot 18H_2O$ ) at low temperatures. A widely used dehydration and desulfurization process is the glycolamine process, in which the treatment solution is a mixture of ethanolamine and a

large amount of glycol. The mixture is circulated through an absorber and a reactivator in the same way as ethanolamine is circulated in the Girbotol process. The glycol absorbs moisture from the hydrocarbon gas passing up the absorber; the ethanolamine absorbs hydrogen sulfide and carbon dioxide. The treated gas leaves the top of the absorber; the spent ethanolamine-glycol mixture enters the reactivator tower, where heat drives off the absorbed acid gases and water.

Solid adsorbent or solid-desiccant dehydration is the primary form of dehydrating natural gas using adsorption, and usually consists of two or more adsorption towers, which are filled with a solid desiccant. Typical desiccants include activated alumina or a granular silica gel material. Wet natural gas is passed through these towers, from top to bottom. As the wet gas passes around the particles of desiccant material, water is retained on the surface of these desiccant particles. Passing through the entire desiccant bed, almost all of the water is adsorbed onto the desiccant material, leaving the dry gas to exit the bottom of the tower.

Solid-adsorbent dehydrators are typically more effective than glycol dehydrators, and are usually installed as a type of straddle system along natural gas pipelines. These types of dehydration systems are best suited for large volumes of gas under very high pressure, and are thus usually located on a pipeline downstream of a compressor station. Two or more towers are required due to the fact that after a certain period of use, the desiccant in a particular tower becomes saturated with water. To 'regenerate' the desiccant, a high-temperature heater is used to heat gas to a very high temperature. Passing this heated gas through a saturated desiccant bed vaporizes the water in the desiccant tower, leaving it dry and allowing for further natural gas dehydration.

Silica gel ( $SiO_2$ ) and alumina ( $Al_2O_3$ ) have good capacities for water adsorption (up to 8% by weight). Bauxite (crude alumina,  $Al_2O_3$ ) adsorbs up to 6% by weight water, and molecular sieves adsorb up to 15% by weight water. Silica is usually selected for dehydration of sour gas because of its high tolerance to hydrogen sulfide and to protect molecular sieve beds from plugging by sulfur.

# Gas Solubility

The gas solubility is the number of standard cubic feet of gas that will dissolve in one stock-tank barrel of crude oil at certain pressure and temperature. The solubility of natural gas in a crude oil is a strong function of the pressure, temperature, API gravity, and gas gravity. For a dilute solution, the partial pressure exerted by a dissolved liquid (a solute)  $a$  in a liquid solvent is given by:

$$p_a = Hx_a$$

$H$  is Henry's law constant for the system and  $x_a$  is the mole fraction of solute. A different value of  $H$  is applicable to each gas-liquid system. As a result: (1) the solubility of a gas generally decreases with any increase in temperature – if a solution in a closed receptacle is heated above the filling temperature during transport or storage, loss of gas can result on opening or liquid discharge; (2) with a 'sparingly-soluble' gas a much-higher partial pressure of that gas is in equilibrium with a solution of a given concentration than is the case with a highly soluble gas; (3) exposure of a solution

to any atmosphere will lead to the take-up, or release, of gas until equilibrium is eventually attained; and (4) rapid absorption of a gas in a liquid in an inadequately vented vessel can result in implosion, i.e., collapse inwards due to a partial vacuum.

Thus, for a particular gas and crude oil to exist at a constant temperature, the solubility increases with pressure until the saturation pressure is reached. At the saturation pressure (bubble-point pressure) all the available gases are dissolved in the oil and the gas solubility reaches its maximum value. Rather than measuring the amount of gas that will dissolve in a given stock-tank crude oil as the pressure is increased, it is customary to determine the amount of gas that will come out of a sample of reservoir crude oil as pressure decreases.

The following empirical correlations for estimating the gas solubility are: (1) Standing's correlation, (2) Vasquez-Biggs correlation, (3) Glaso's correlation, (4) Marhoun's correlation, and (5) Petrosky-Farshad correlation.



# Gas-Condensate Reservoirs

Gas-condensate reservoirs are those reservoirs that produce light-colored (yellow-to-brown) liquids with a gravity typically above 45° API and properties that reflect the predominance of the low boiling constituents (Table 1, Table 2). Oil reservoirs also produce condensate insofar as the se reservoirs have a dissolved gas content in the range of zero (dead oil) to a few thousand cubic feet per barrel, whereas in gas reservoirs 1 bbl of liquid (condensate) is vaporized in 100,000 scf of gas or more, and from which, therefore, a small or negligible amount of hydrocarbon liquid is obtained in surface separators. However, gas-condensate production is predominantly in the form of a *gas* from which liquid is *condensed* in the surface separators; the liquid is sometimes

called by an older name, *distillate*, and also sometimes simply oil because of the resemblance to light crude oil.

For comparison, the mole compositions and some additional properties of five single-phase reservoir fluids are presented (Table 3). The volatile oil is intermediate between the gas-condensate and the black, or heavy, oil types. Production with gas-oil ratios greater than 100,000 scf/bbl is commonly called *lean* or *dry gas*, although there is no generally recognized dividing line between the two categories. In some legal work, statutory gas wells are those with gas-oil ratios in excess of 100,000 scf/bbl. The term *wet gas* is sometimes used as being more or less equivalent to gas-condensate. In the gas-oil ratios, general trends

**Table 1** Variable composition of gas condensate.

Components	% w/w
Propane	20 to 60
Ethane	1 to 60
n-Pentane	5 to 25
n-Hexane	2 to 13
Heptane	1 to 10
Octane	1 to 10
n-Butane	2 to 5
Cyclohexane	1 to 5
Toluene	0.1 to 5
Ethyl benzene	0.1 to 5
Xylenes	0.1 to 5
Benzene	0 to 2
Higher m. wt. hydrocarbons	0.1 to 5

\*The composition varies with geographic location, geologic formation, temperature, and pressure

**Table 2** An example of the physical and chemical properties of gas condensate\*.

Appearance	Amber to dark brown
Physical Form	Liquid
Odor	Hydrogen sulfide, mercaptans
Vapor Pressure	5–15 psia (Reid VP) @ 37.8°C (100°F)
Vapor Density (air = 1)	1
Specific Gravity (water = 1)	0.6 - 0.8 @ (15.6°C (60°F)
Bulk Density	6.25 lbs/gal
Initial Boiling Point/Range	-29 to 427°C (-20 to 800°F)
VOC content (% v/v)	50
Flash Point	-46 °C (-51 °F)
Lower Explosive Limits (vol % in air)	1.1
Upper Explosive Limits (vol % in air)	6.0
Auto-ignition Temperature	310 °C (590 °F)
Solubility in water	Negligible

\*The properties vary with the composition which varies with geographic location, geologic formation, temperature, and pressure

**Table 3** Mole composition of single-phase reservoir fluids.

Component	Black oil*	Volatile oil	Gas-condensate	Dry gas	Gas
C1	48.83	64.36	87.07	95.85	86.67
C2	2.75	7.52	4.39	2.67	7.77
C3	1.93	4.74	2.29	0.34	2.95
C4	1.6	4.12	1.74	0.52	1.73
C5	1.15	2.97	0.83	0.08	0.88
C6	1.59	1.38	0.6	0.12	N/A
C7+	42.15	14.91	3.8	0.42	N/A
	100	100	100	100	100
Mol. wt., C7+ fraction	225	181	112	157	
GOR, scf/bbl	625	2000	18,200	105,000	N/A
Tank gravity, API	34.3	50.1	60.8	54.7	
Liquid color	Greenish black	Medium orange	Light straw	Water white	

\*A term that should be discouraged from use since it does not adequately describe the character of the oil other than the color

are noticeable in the methane and heptanes-plus content of the fluids and the color of the tank liquids. Although there is good correlation between the molecular weight of the heptanes-plus and the gravity of the stock tank liquid, there is virtually no correlation between the gas-oil ratios and the gravities of the stock tank liquids, except

that most black oil reservoirs have gas-oil ratios below 1000 scf/bbl and stock tank liquid gravity below 45° API. The gas-oil ratios are a good indication of the overall composition of the fluid, high gas-oil ratios being associated with low concentrations of pentanes and heavier, and vice versa.

# Gaseous Fuels

*Natural gas*, which is predominantly methane, occurs in underground reservoirs separately or in association with crude oil. The principal types of gaseous fuels are oil (distillation) gas, reformed natural gas, and reformed propane or liquefied petroleum gas (LPG) (Tables 1 – 3). The principal constituent of natural gas is methane ( $\text{CH}_4$ ). Other constituents are paraffinic hydrocarbons such as ethane ( $\text{CH}_3\text{CH}_3$ ), propane ( $\text{CH}_3\text{CH}_2\text{CH}_3$ ), and the butanes [ $\text{CH}_3\text{CH}_2\text{CH}_2\text{CH}_3$  and/or  $(\text{CH}_3)_3\text{CH}$ ]. Many natural gases contain nitrogen ( $\text{N}_2$ ) as well as carbon dioxide ( $\text{CO}_2$ ) and hydrogen sulfide ( $\text{H}_2\text{S}$ ). Trace quantities of argon, hydrogen, and helium may also be present. Generally, the hydrocarbons having a higher molecular weight than methane, carbon dioxide, and hydrogen sulfide are removed from natural gas prior to its use as a fuel. Gases produced in a refinery contain methane, ethane, ethylene, propylene, hydrogen, carbon monoxide, carbon dioxide, and nitrogen, with low concentrations of water vapor, oxygen, and other gases.

*Liquefied petroleum gas (LPG)* is the term applied to certain specific hydrocarbons and their mixtures, which exist in the gaseous state under atmospheric ambient conditions but can be converted to the liquid state under conditions of moderate pressure at ambient temperature. These are the light hydrocarbons fraction of the paraffin series, derived from refinery processes, crude oil stabilization plants and natural gas processing plants comprising propane ( $\text{CH}_3\text{CH}_2\text{CH}_3$ ), butane ( $\text{CH}_3\text{CH}_2\text{CH}_2\text{CH}_3$ ), *iso*-butane [ $\text{CH}_3\text{CH}(\text{CH}_3)\text{CH}_3$ ] and to a lesser extent propylene ( $\text{CH}_3\text{CH}=\text{CH}_2$ ), or butylene ( $\text{CH}_3\text{CH}_2\text{CH}=\text{CH}_2$ ). The most common commercial products are propane, butane, or some mixture of the two and are generally extracted from natural gas or crude petroleum. Propylene and butylenes result from cracking other hydrocarbons in a petroleum refinery and are two important chemical feedstocks.

*Mixed gas* is a gas prepared by adding natural gas or liquefied petroleum gas to a manufactured gas, giving a product of better utility and higher heat content or Btu value.

**Table 1** Types of gaseous fuels

(1) Fuels naturally found in nature:
Natural gas: (1) From crude oil reservoirs and (2) from natural gas reservoirs; most volatile fraction from the distillation of oil, petroleum gas (mainly butane, propane)
Methane from coal mines (Firedamp; coalbed methane)
Methane the digestion of biomass by bacteria (landfill gas, digester gas)
(2) Fuel gases made from solid fuel
Gases derived from Coal
(a) Pyrolysis, carbonization: the product of the heating of a solid or liquid to devolatilize the substance to form a char, coke or charcoal
(b) Coke oven gas
(c) Gas from charcoal production
(d) Gasification - The product of complete gasification of a solid or liquid feedstock - i.e. including the char. Only residue is ash.
Producer gas - Low CV gas from partial combustion of coal in air
Blue or Water Gas - Med. CV gas from gasification of coal with steam.
Carburetted Water gas - Med. to High CV gas. Town gas.
Gases derived from waste and biomass
From other industrial processes (Blast furnace gas)
(3) Gases made from petroleum
Liquefied Petroleum gas (LPG)
Refinery gases: formed by the cracking higher boiling fractions
Gases from residue or heavy oil gasification
(4) Gases from some fermentation process

**Table 2** General properties and description of gaseous fuels.

	Molecular weight	Specific gravity	Boiling point degrees F	Ignition temperature degrees F	Flash point degrees F	Flammability limits in air % v/v
Methane	16.0	0.553	-258.7	900-1170	Gas	5.0-15.0
Ethane	30.1	0.572	-127.5	959	Gas	3.0-12.5
Ethylene	28.0		-154.7	914	Gas	2.8-28.6
Propane	44.1		-43.8	842	Gas	2.1-10.1
Propylene	42.1		-53.9	856	Gas	2.00-11.1
n-Butane	58.1	0.601	31.1	761	-76	1.86-8.41
iso-Butane	58.1		10.9	864	-117	1.80-8.44
n-Butene	56.1	0.595	21.2	829	Gas	1.98-9.65
iso-Butene	56.1		19.6	869	Gas	1.8-9.0

**Table 3** Composition of gaseous fuels\*.

Composition (%)										
Fuel	Carbon dioxide (CO <sub>2</sub> )	Carbon monoxide (CO)	Methane (CH <sub>4</sub> )	Butane (C <sub>4</sub> H <sub>10</sub> )	Ethane (C <sub>2</sub> H <sub>6</sub> )	Propane (C <sub>3</sub> H <sub>8</sub> )	Hydrogen (H <sub>2</sub> )	Hydrogen sulfide (H <sub>2</sub> S)	Oxygen (O <sub>2</sub> )	Nitrogen (N <sub>2</sub> )
Carbon Monoxide		100								
Coal Gas	3.8	28.4	0.2				17.0			50.6
Coke Oven Gas	2.0	5.5	32				51.9		0.3	4.8
Digester Gas	30		64				0.7	0.8		2.0
Hydrogen							100			
Landfill Gas	47	0.1	47				0.1	0.01	0.8	3.7
Natural Gas	0-0.8	0-0.45	82-93		0-15.8		0-1.8	0-0.18	0-0.35	0.5-8.4
Propane Gas				0.5-0.8	2.0-2.2	73-97				

\*Composition will vary according to the source of the fuel.



## Gaseous Hydrocarbons – General Properties

The number of carbon atoms in a member of the paraffin series determines whether the hydrocarbon will exist as a gas, a liquid, or a solid under standard conditions of temperature and pressure (STP' 60 °F, 760 mm Hg). Methane (CH<sub>4</sub>) is a gas under all naturally occurring temperature and pressure conditions. Ethane (C<sub>2</sub>H<sub>6</sub>), propane (C<sub>3</sub>H<sub>8</sub>), butane (C<sub>4</sub>H<sub>10</sub>) and its isomers are gaseous under standard surface conditions (Table) but may exist in either gaseous or liquid phase under the elevated temperature and pressure conditions found in subsurface reservoirs. On the

other hand, members of the paraffin series with between 5 and 17 carbon atoms in their molecular structures (such as pentane, C<sub>5</sub>H<sub>12</sub>, hexane, C<sub>6</sub>H<sub>14</sub>, heptane, C<sub>7</sub>H<sub>16</sub>, octane, C<sub>8</sub>H<sub>18</sub>) are liquid under standard surface conditions and most temperature and pressure conditions encountered in subsurface reservoirs. Members of the paraffin series with more than 17 carbon atoms are solid under most naturally occurring temperatures and pressures and when isolated from crude oil form the mixture known as paraffin wax.

**Table** Properties of gaseous (C<sub>1</sub>-C<sub>4</sub>) paraffin hydrocarbons.

Gas	Molecular weight	Boiling point 1 atm, °C (OF)	Density at 60 °F g/liter	Density Relative to air = 1
Methane	16.043	-161.5 (-258.7)	0.6786	0.5547
Ethylene	28.054	-103.7 (-154.7)	1.1949	0.9768
Ethane	30.068	-88.6 (-127.5)	1.2795	1.046
Propylene	42.081	-47.7 (-53.9)	1.8052	1.4757
Propane	44.097	-42.1 (-43.8)	1.8917	1.5464
1,2- Butadiene	54.088	10.9 (51.6)	2.3451	1.9172
1,3-Butadiene	54.088	-4.4 (24.1)	2.3491	1.9203
1-Butene	56.108	-6.3 (20.7)	2.4442	1.9981
cis-2-Butene	56.108	3.7 (38.7)	2.4543	2.0063
trans-2-Butene	56.108	0.9 (33.6)	2.4543	2.0063
iso-Butene	56.104	-6.9 (19.6)	2.4442	1.9981
n-Butane	58.124	-5.4 (31.1)	2.532	2.0698
iso-Butane	58.124	-11.7 (10.9)	2.5268	2.0656



# Gasification – Chemistry

Carbonaceous materials such as heavy oil, tar sand bitumen, and residua contain carbon, hydrogen, nitrogen, and oxygen, and sulfur can be converted to gaseous products (gasification) leading to a variety of other saleable products. In the gasifier, the carbonaceous feedstock is heated by combustion of a part of the fuel and the combustion gases are then reduced by being passed through a bed of fuel at high temperature.

In complete combustion, carbon dioxide is obtained from the carbon and water from the hydrogen. Oxygen from the fuel will of course be incorporated in the combustion products, thereby decreasing the amount of combustion air needed. Oxidation, or combustion, is described by the following chemical reaction formulae:

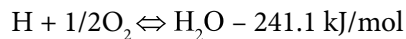
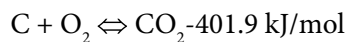

A minus sign indicates that heat is generated in the reaction, a positive sign that the reaction requires heat. In all types of gasifiers, the carbon dioxide ( $\text{CO}_2$ ) and water vapor ( $\text{H}_2\text{O}$ ) are converted (reduced) as much as possible to carbon monoxide, hydrogen and methane, which are the main combustible components of producer gas.

The most important reactions that take place in the reduction zone of a gasifier are:

- $\text{C} + \text{CO}_2 \Leftrightarrow 2\text{CO} + 164.9 \text{ kJ/kmol}$
- $\text{C} + \text{H}_2\text{O} \Leftrightarrow \text{CO} + \text{H}_2 + 122.6 \text{ kJ/kmol}$
- $\text{CO} + \text{H}_2 \Leftrightarrow \text{CO} + \text{H}_2\text{O} + 42.3 \text{ kJ/kmol}$
- $\text{C} + 2\text{H}_2 \Leftrightarrow \text{CH}_4 \quad 0$
- $\text{CO} + 3\text{H}_2 \Leftrightarrow \text{CH}_4 + \text{H}_2\text{O} - 205.9 \text{ kJ/kmol}$

Equations (a) and (b), which are the main reactions of reduction, show that reduction requires heat. Therefore, the gas temperature will decrease during reduction. Reaction (c) describes the so-called water-gas equilibrium. For each

temperature, in theory, the ratio between the product of the concentration of carbon monoxide ( $\text{CO}$ ) and water vapor ( $\text{H}_2\text{O}$ ) and the product of the concentrations of carbon dioxide ( $\text{CO}_2$ ) and hydrogen ( $\text{H}_2$ ) is fixed by the value of the water gas equilibrium constant ( $K_{WE}$ ). In practice, the equilibrium composition of the gas will only be reached in cases where the reaction rate and the time for reaction are sufficient. The reaction rate decreases with decreasing and, in the case of the water-gas equilibrium, the reaction rate becomes so low below  $700^\circ\text{C}$  that the reaction virtually ceases and the gas composition then remains unchanged.

$$K_{WE} = \frac{(\text{CO}) \times (\text{H}_2\text{O})}{(\text{CO}_2) \times (\text{H}_2)}$$

An important factor determining the actual technical operation, as well as the economic feasibility of using a gasifier system, is the gasification efficiency, which can be represented by:

$$\eta_m = \frac{H_g \times Q_g}{H_s \times M_s} \times 100 (\%)$$

In which:  $\eta_m$  is the mechanical gasification efficiency (%),  $H_g$  is the heating value of the gas ( $\text{kJ/m}^3$ ),  $Q_g$  is the volume flow of gas ( $\text{m}^3/\text{s}$ ),  $H_s$  is the lower heating value of gasifier fuel ( $\text{kJ/kg}$ ), and  $M_s$  is the gasifier solid fuel consumption ( $\text{kg/s}$ ).

If the gas is used for direct burning, the gasification efficiency is sometimes defined as:

$$\eta_{th} = \frac{(H_g \times Q_g) + (Q_g \times \rho_g \times C_p \times \Delta T)}{H_s \times M_s} \times 100$$

In which  $\eta_{th}$  is the thermal gasification efficiency (%),  $\rho_g$  is the density of the gas ( $\text{kg/m}^3$ ),  $C_p$  specific heat of the gas ( $\text{kJ/}$

**Table** Gasification reactions.

$2\text{C} + \text{O}_2 \rightarrow 2\text{CO}$
$\text{C} + \text{O}_2 \rightarrow \text{CO}_2$
$\text{C} + \text{CO}_2 \rightarrow 2\text{CO}$
$\text{CO} + \text{H}_2\text{O} \rightarrow \text{CO}_2 + \text{H}_2$ (shift reaction)
$\text{C} + \text{H}_2\text{O} \rightarrow \text{CO} + \text{H}_2$ (water gas reaction)
$\text{C} + 2\text{H}_2 \rightarrow \text{CH}_4$
$2\text{H}_2 + \text{O}_2 \rightarrow 2\text{H}_2\text{O}$
$\text{CO} + 2\text{H}_2 \rightarrow \text{CH}_3\text{OH}$
$\text{CO} + 3\text{H}_2 \rightarrow \text{CH}_4 + \text{H}_2\text{O}$ (methanation reaction)
$\text{CO}_2 + 4\text{H}_2 \rightarrow \text{CH}_4 + 2\text{H}_2\text{O}$
$\text{C} + 2\text{H}_2\text{O} \rightarrow 2\text{H}_2 + \text{CO}_2$
$2\text{C} + \text{H}_2 \rightarrow \text{C}_2\text{H}_2$
$\text{CH}_4 + 2\text{H}_2\text{O} \rightarrow \text{CO}_2 + 4\text{H}_2$

$\text{kg}^\circ\text{K}$ ),  $\Delta T$  is the temperature difference between the gas at the burner inlet and the fuel entering the gasifier ( $^\circ\text{K}$ ).

Depending on type and design of the gasifier as well as on the characteristics of the fuel mechanical efficiency of the unit ( $\eta_m$ ) may vary between 60 and 75% and, in the case of thermal applications, the thermal efficacy of the unit ( $\eta_{th}$ ) can be as high as 93%.

## Gasification – Refinery Resids

Because of the increased need for transportation fuels, high conversion refineries will move to gasification of various feedstocks (such as residua) (Table) for the development of alternative fuels and to enhance equipment usage. A major trend in the refining industry market demand for refined products will be in synthesizing fuels from simple basic reactants (e.g., synthesis gas) when it becomes uneconomical to produce super clean transportation fuels through conventional refining processes. Fischer-Tropsch plants together

with IGCC systems will be integrated with or even into refineries, which will offer the advantage of high-quality products.

Gasification will become commonplace on refinery sites and a variety of feedstocks and the role of the *gasification refinery* will approach that of a petrochemical complex, capable of supplying the traditional refined products, but also meeting much more severe specifications, and petrochemical intermediates such as olefins, aromatics, hydrogen and methanol.

**Table** Types of refinery feedstocks available for gasification on-site.

Ultimate analysis	Units	Vacuum residue	Visbreaker tar	Asphalt	Petcoke
C	wt/wt	84.9%	86.1%	85.1%	88.6%
H	wt/wt	10.4%	10.4%	9.1%	2.8%
N <sup>a</sup>	wt/wt	0.5%	0.6%	0.7%	1.1%
S <sup>a</sup>	wt/wt	4.2%	2.4%	5.1%	7.3%
O	wt/wt		0.5%		0.0%
Ash	wt/wt	0.0%		0.1%	0.2%
Total	wt/wt	100.0%	100.0%	100.0%	100.0%
H <sub>2</sub> /C Ratio	mol/mol	0.727	0.720	0.640	0.188
<b>Density</b>					
Specific Gravity	60°/60°	1.028	1.008	1.070	0.863
API Gravity	°API	6.2	8.88	0.8	-
<b>Heating Values</b>					
HHV (dry)	M Btu/lb	17.72	18.6	17.28	14.85
LHV (dry)	M Btu/lb	16.77	17.6	16.45	14.48



# Gas-Liquid Solubility

For a dilute solution, the partial pressure exerted by a dissolved liquid (a solute) 'a' in a liquid solvent is given by:

$$p_a = Hx_a$$

In the equation,  $H$  is Henry's law constant for the system and  $x_a$  is the mole fraction of solute. A different value of  $H$  is applicable to each gas-liquid system. As a result: (1) the solubility of a gas generally decreases with any increase in temperature and if a solution in a closed receptacle is heated

above the filling temperature during transport or storage, loss of gas can result on opening or liquid discharge, (2) with a 'sparingly-soluble' gas a much-higher partial pressure of that gas is in equilibrium with a solution of a given concentration than is the case with a highly soluble gas, (3) exposure of a solution to any atmosphere will lead to the take-up, or release, of gas until equilibrium is eventually attained, and (4) rapid absorption of a gas in a liquid in an inadequately vented vessel can result in implosion, i.e., collapse inwards due to a partial vacuum.





# Gas-Oil Ratio

The produced gas-oil ratio (GOR) at any particular time is the ratio of the standard cubic feet of *total* gas being produced at any time to the stock-tank barrels of oil being produced at that same instant. Hence, the name *instantaneous gas-oil ratio* is described by the following expression:

$$\text{GOR} = R_s + \left( \frac{K_{rg}}{K_{ro}} \right) \left( \frac{\mu_o B_o}{\mu_g B_g} \right)$$

GOR is the instantaneous gas-oil ratio, scf/STB  $R$  is the gas solubility, scf/STB,  $k_{rg}$  is the relative permeability to gas,  $k_{ro}$  is the relative permeability to oil,  $B_o$  is the oil formation volume factor, bbl/STB,  $B_g$  is the gas formation volume factor, bbl/scf,  $\mu_o$  is the oil viscosity, cp, and  $\mu_g$  is the gas viscosity, cp.



# Gas-Oil Separation

The first step in processing the mixed-stream from a well is to separate the crude oil, natural gas, and water phases into separate streams. A gas-oil separator is a vessel that does this job. Gas-oil separators can be horizontal, vertical, or spherical.

Oil-field separators can be classified into two types based on the number of phases to separate: (1) two-phase separators, which are used to separate gas from oil in oil fields, or gas from water for gas fields and (2) three-phase separators, which are used to separate the gas from the liquid phase, and water from oil. The liquid (oil, emulsion) leaves at the bottom through a level-control or dump valve. The gas leaves the vessel at the top, passing through a mist extractor to remove the small liquid droplets in the gas.

Separators can be categorized according to their operating pressure. Low-pressure units handle pressures of 10 to 180 psi (69 to 1241 kPa). Medium-pressure separators operate from 230 to 700 psi (1586 to 4826 kPa). High-pressure units handle pressures of 975 to 1500 psi (6722 to 10,342 kPa).

Gravity segregation is the main force that accomplishes the separation, which means the heaviest fluid settles to the bottom and the lightest fluid rises to the top. The degree of separation between gas and liquid inside the separator depends on the following factors: separator operating pressure, the residence time of the fluid mixture, and the type of flow of the fluid (turbulent flow allows more gas bubbles to escape than laminar flow).



# Gasoline – Component Streams

*Gasoline*, also called *gas* (United States and Canada), or *petrol* (Great Britain) or *benzine* (Europe) is a mixture of volatile, flammable liquid hydrocarbons derived from petroleum and used as fuel for internal-combustion engines. It is also used as a solvent for oils and fats. Originally a by-product of the petroleum industry (kerosene being the principal product), gasoline became the preferred automobile fuel because of its high energy of combustion and capacity to mix readily with air in a carburetor.

Gasoline is a mixture of hydrocarbons that usually boil below 180 °C (355 °F) or, at most, below 200 °C (390 °F). The hydrocarbon constituents in this boiling range are those that have four to twelve carbon atoms in their molecular structure and fall into three general types: paraffins (including the cycloparaffins and branched materials), olefins, and aromatics.

However, despite the variations in the composition of the gasoline produced by the various available processes, this material is rarely if ever suitable for use as such. It is at this stage of a refinery operation that blending becomes important. In fact, many refinery products are typically the result of blending several component streams or blending stocks. In most cases, product blending is accomplished by controlling the volumes of blend stocks from individual component storage tanks that are mixed in the finished product storage tank. Samples of the finished blend are then analyzed by laboratory testing for all product specifications prior to shipping. Alternatively, *in-line blending* refers to pipeline

shipments in which the finished product is actually blended directly into the product pipeline (as opposed to a standing product storage tank).

**Table** Component streams for gasoline.

<i>Stream</i>	<i>Producing Process</i>	<i>Boiling Range</i>	
		°C	°F
<u>Paraffinic</u>			
Butane	Distillation Conversion	0	32
Iso-pentane	Distillation Conversion Isomerization (1)	27	81
Alkylate	Alkylation (2)	40–150	105–300
Isomerate	Isomerization	40–70	105–160
Naphtha	Distillation	30–100	85–212
Hydrocrackate	Hydrocracking	40–200	105–390
<u>Olefinic</u>			
Catalytic naphtha	Catalytic cracking	40–200	105–390
Cracked naphtha	Steam cracking	40–200	105–390
Polymer	Polymerization (3)	60–200	140–390
<u>Aromatic</u>			
Catalytic reformat	Catalytic reforming (4)	40–200	105–390



# Gas-to-Liquids

Gas to liquids (GTL) is a process to convert natural gas or other gaseous hydrocarbons into longer-chain hydrocarbons such as gasoline or diesel fuel. Methane-rich gases are converted into liquid synthetic fuels either via direct conversion – using non-catalytic processes that convert methane to methanol in one step – or via synthesis (syngas) as an intermediate, such as in the Fischer Tropsch, Mobil and syngas to gasoline plus processes.

Direct conversion of methane to higher hydrocarbons may result from a number of reactions:

*Dehydrogenative self-interaction:*



*Oxidative coupling*

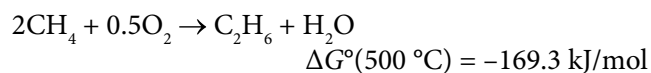
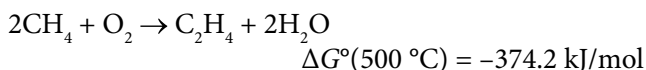

*Partial oxidation*

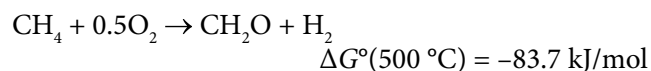

*Oxydehydrochlorination*

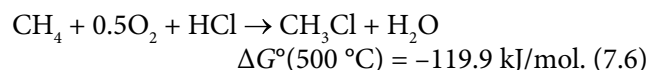

*Complete oxidation*

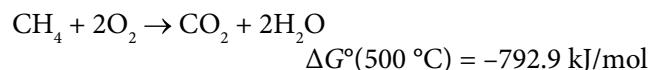





# Geological Time Scale

The geologic processes that were instrumental in the formation of petroleum and natural gas have been operative throughout geologic history. Whether fault movement, uplift, subsidence, folding, or sedimentary deposition, it occurs slowly and imperceptibly. Plate movement varies from only about one-half inch per year to five inches per year, at the most. A motion of just two inches a year adds up to 30 miles in only one million years. Some plates have

been in motion for 100 million years for a total movement of 3,000 miles over that period of time. There are various geologic eras and periods that correlate with producing formations throughout the world. Only the Cretaceous period of the Mesozoic Era, and the Paleocene, Eocene, Oligocene, Miocene, Pliocene, and Pleistocene are, or have been, significantly represented in oil fields of the United States.

Era	Period	Epoch	Duration (years × 10 <sup>6</sup> )*	Years ago (years × 10 <sup>6</sup> )*
Cenozoic	Quaternary	Holocene	<10,000 years ago	
		Pleistocene	2	.01
	Tertiary	Pliocene	11	2
		Miocene	12	13
		Oligocene	11	25
		Eocene	22	36
		Paleocene	71	58
Mesozoic	Cretaceous		71	65
	Jurassic		54	136
	Triassic		35	190
Paleozoic	Permian		55	225
	Carboniferous		65	280
	Devonian		60	345
	Silurian		20	405
	Ordovician		75	425
	Cambrian		100	500
Precambrian			3,380	600

\*Approximations.

**Figure** The geological time scale.



# Geothermal Gradient

The geothermal gradient is the rate of increasing temperature with respect to increasing depth in the interior of the Earth. Away from tectonic plate boundaries, the gradient is approximately 25 °C per kilometer of depth (1 °F per 70 feet of depth) near the surface in most of the world. However, the geothermal gradient varies with location and is typically measured by determining the bottom open-hole temperature after borehole drilling. Although the geothermal gradient varies from place to place, it is generally on the order of 25 to 30 °C/km (15 °F/1000 ft or 120 °C/1000 feet, i.e., 0.015 °C per foot of depth or 0.012 °C per foot of depth).

Knowledge of the geothermal gradient is important for the oil, gas, and geothermal energy industries. Downhole logging tools must be hardened if they are to function in deep oil and gas wells in areas of high gradient. Calculation of geothermal gradients in the geological past is a critical part of modeling the generation of hydrocarbons in sedimentary basins.

In the geosciences, the measurement of temperature (T) is associated with heat flow (Q):

$$Q = K\Delta T/\Delta Z$$

K is the thermal conductivity of the rock.

Temperatures at the surface of the Earth are controlled by the sun and the atmosphere, except for areas such as hot springs and lava flows. From shallow depths to about 200 feet below the surface, the temperature is constant at about 11 °C (55 °F). In a zone between the near surface and about 400 feet (122 m), the gradient is variable because it is affected by atmospheric changes and circulating groundwater. Below that zone, temperature almost always increases with depth. However, the rate of increase with depth (geothermal gradient) varies considerably with both tectonic setting and the thermal properties of the rock.

High gradients (up to 11 °F/100 feet, or 200 °C/km) are observed along the oceanic spreading centers (for example, the Mid-Atlantic Rift) and along island arcs (for example, the Aleutian chain). The high rates are due to molten volcanic rock (magma) rising to the surface. Low gradients are observed in tectonic subduction zones because of thrusting of cold, water-filled sediments beneath an existing crust. The tectonically stable shield areas and sedimentary basins have average gradients that typically vary from 0.82 to 1.65 °F/100 feet (15 to 30 °C/km).



# Glycol

Glycol (ethylene glycol) is produced from ethylene via the intermediate ethylene oxide which reacts with water to produce ethylene glycol:

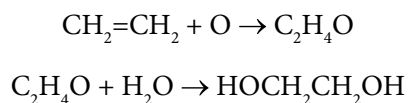

Structurally,  $\text{C}_2\text{H}_4\text{O}$  is 

This reaction can be catalyzed by either acids or bases or can occur at neutral pH under elevated temperatures. The highest yields of ethylene glycol occur at acidic or neutral pH with a large excess of water. Under these conditions, ethylene glycol yields of 90% can be achieved. The major byproducts are the ethylene glycol oligomers diethylene glycol, and triethylene glycol.

**Table** Properties of ethylene glycol, diethylene glycol, and triethylene glycol.

	Ethylene glycol	Diethylene glycol	Triethylene glycol
Chemical formula	$\text{C}_2\text{H}_6\text{O}_2$	$\text{C}_4\text{H}_{10}\text{O}_3$	$\text{C}_6\text{H}_{14}\text{O}_4$
Acronym	MEG	DEG	TEG
Molar mass	$62.07 \text{ g}\cdot\text{mol}^{-1}$	$106.12 \text{ g/mol}$	$150.17 \text{ g}\cdot\text{mol}^{-1}$
Appearance	Clear, colorless liquid	Colorless liquid	Colorless liquid
Density	$1.1132 \text{ g/cm}^3$	$1.118 \text{ g/cm}^3$	$1.1255 \text{ g/cm}^3$
Melting point	$-12.9 \text{ }^\circ\text{C}$ ( $8.8 \text{ }^\circ\text{F}$ )	$-10.45 \text{ }^\circ\text{C}$ ( $13.19 \text{ }^\circ\text{F}$ )	$-7 \text{ }^\circ\text{C}$ ( $19 \text{ }^\circ\text{F}$ )
Boiling point	$197.3 \text{ }^\circ\text{C}$ ( $387.1 \text{ }^\circ\text{F}$ )	$244 \text{ }^\circ\text{C}$ ( $471 \text{ }^\circ\text{F}$ )	$285 \text{ }^\circ\text{C}$ ( $545 \text{ }^\circ\text{F}$ )
Solubility in water	Miscible	Miscible	Miscible



# Grease

*Grease* is lubricating oil to which a thickening agent has been added for the purpose of holding the oil to surfaces that must be lubricated. The development of the chemistry of grease formulations is closely linked to an understanding of

the physics at the interfaces between the machinery and the grease. With this insight, it is possible to formulate greases that are capable of operating in increasingly demanding and wide-ranging conditions.

Types of grease.

NLGI grades	Thickeners	Penetration index	Drop point °c	Uses
1,2,3	Sodium soap	250–340	180–185	Bearings and gears
1,2	Aluminium soap	265–340	90	Gears
0,1,2,3	Calcium soap	220–385	80–90	Bearings, hydraulic presses, water pumps etc.
2	Lithium-calcium soap	265–295	165–180	Gears, bearing and water pumps etc
0,1,2	Lithium soap	265–385	170–190	Gears, bearing and joints etc
2	Lithium compound with synthetic base	265–295	>250	Aviation and automobile gears and bearing





# Greek Alphabet

Capital	Lower case	Name	Capital	Lower case	Name
A	$\alpha$	Alpha	N	$\nu$	Nu
OB	$\beta$	Beta	$\Xi$	$\xi$	Xi
$\Gamma$	$\gamma$	Gamma	O	$o$	Omicron
$\Delta$	$\delta$	Delta	$\Pi$	$\pi$	Pi
E	$\epsilon$	Epsilon	P	$\rho$	Rhoi
Z	$\zeta$	Zeta	$\Sigma$	$\sigma$	Sigma
H	$\eta$	Eta	T	$\tau$	Tau
$\Theta$	$\theta$	Theta	$\Upsilon$	$\upsilon$	Upsilon
I	$\iota$	Iota	$\Phi$	$\varphi$	Phi
K	$\kappa$	Kappa	X	$\chi$	Chi
$\Lambda$	$\lambda$	Lambda	$\Psi$	$\psi$	Psi
M	$\mu$	Mu	$\Omega$	$\omega$	Omega



# Hazardous Chemicals

A hazardous chemical is a type of chemical that can, by exposure, cause acute or long-term detrimental health effects. There are many types of hazardous chemicals, including neurotoxins, immune agents, dermatologic agents, carcinogens, reproductive toxins, systemic toxins, asthmagens, pneumoconiotic

agents, and sensitizers. These hazards can cause physical and/or health risks. Thus, hazardous chemicals and toxic substances pose a wide range of health hazards (such as irritation, sensitization, and carcinogenicity) and physical hazards (such as flammability, corrosion, and explosive capability).

**Table** Toxic and reactive highly hazardous chemicals which present the potential for a catastrophic event at or above the threshold quantity.

Chemical name	CAS*	TQ**
Acetaldehyde	75-07-0	2500
Acrolein (2-Popenal)	107-02-8	150
Acrylyl Chloride	814-68-6	250
Allyl Chloride	107-05-1	1000
Allylamine	107-11-9	1000
Alkylaluminum	Varies	5000
Ammonia, Anhydrous	7664-41-7	10000
Ammonia solutions (>than 44% w/w)	7664-41-7	15000
Ammonium Perchlorate	7790-98-9	7500
Ammonium Permanganate	7787-36-2	7500
Arsine (Arsenic Hydride, AsH <sub>3</sub> )	7784-42-1	100
Bis(Chloromethyl) Ether	542-88-1	100
Boron Trichloride	10294-34-5	2500
Boron Trifluoride	7637-07-2	250
Bromine	7726-95-6	1500
Bromine Chloride	13863-41-7	1500
Bromine Pentafluoride	7789-30-2	2500
Bromine Trifluoride	7787-71-5	15000
3-Bromopropyne (Propargyl Bromide)	106-96-7	100
Butyl Hydroperoxide (Tertiary)	75-91-2	5000
Butyl Perbenzoate (Tertiary)	614-45-9	7500

Chemical name	CAS*	TQ**
Carbonyl Chloride (see Phosgene)	75-44-5	100
Carbonyl Fluoride	353-50-4	2500
Cellulose Nitrate (>12.6% w/w nitrogen)	9004-70-0	2500
Chlorine	7782-50-5	1500
Chlorine Dioxide	10049-04-4	1000
Chlorine Pentafluoride	13637-63-3	1000
Chlorine Trifluoride	7790-91-2	1000
Chlorodiethylaluminum	96-10-6	5000
1-Chloro-2,4-Dinitrobenzene	97-00-7	5000
Chloromethyl Methyl Ether	107-30-2	500
Chloropicrin	76-06-2	500
Chloropicrin and Methyl Bromide mixture	None	1500
Chloropicrin and Methyl Chloride mixture	None	1500
Cumene Hydroperoxide	80-15-9	5000
Cumene Hydroperoxide	80-15-9	5000
Cyanogen	460-19-5	2500
Cyanogen Chloride	506-77-4	500
Cyanuric Fluoride	675-14-9	100
Diacetyl Peroxide (>70%)	110-22-5	5000
Diazomethane	334-88-3	500
Dibenzoyl Peroxide	94-36-0	7500
Diborane	19287-45-7	100

(Continued)

Table Cont.

Chemical name	CAS*	TQ**
Dibutyl Peroxide (Tertiary)	110-05-4	5000
Dichloro Acetylene	7572-29-4	250
Dichlorosilane	4109-96-0	2500
Diethylzinc	557-20-0	10000
Diisopropyl Peroxydicarbonate	105-64-6	7500
Dilauroyl Peroxide	105-74-8	7500
Dimethyldichlorosilane	75-78-5	1000
1,1-Dimethylhydrazine	57-14-7	1000
Dimethylamine, Anhydrous	124-40-3	2500
2,4-Dinitroaniline	97-02-9	5000
Ethyl Methyl Ketone Peroxide	1338-23-4	5000
Ethyl Nitrite	109-95-5	5000
Ethylamine	75-04-7	7500
Ethylene Fluorohydrin	371-62-0	100
Ethylene Oxide	75-21-8	5000
Ethyleneimine	151-56-4	1000
Fluorine	7782-41-4	1000
Formaldehyde (Formalin)	50-00-0	1000
Furan	110-00-9	500
Hexafluoroacetone	684-16-2	5000
Hydrochloric Acid, Anhydrous	7647-01-0	5000
Hydrofluoric Acid, Anhydrous	7664-39-3	1000
Hydrogen Bromide	10035-10-6	5000
Hydrogen Chloride	7647-01-0	5000
Hydrogen Cyanide, Anhydrous	74-90-8	1000
Hydrogen Fluoride	7664-39-3	1000
Hydrogen Peroxide (>52% w/w)	7722-84-1	7500
Hydrogen Selenide	7783-07-5	150
Hydrogen Sulfide	7783-06-4	1500
Hydroxylamine	7803-49-8	2500
Iron, Pentacarbonyl	13463-40-6	250
Isopropylamine	75-31-0	5000
Ketene	463-51-4	100
Methacrylaldehyde	78-85-3	1000
Methacryloyl Chloride	920-46-7	150
Methacryloyloxyethyl Isocyanate	30674-80-7	100
Methyl Acrylonitrile	126-98-7	250
Methylamine, Anhydrous	74-89-5	1000
Methyl Bromide	74-83-9	2500
Methyl Chloride	74-87-3	15000
Methyl Chloroformate	79-22-1	500
Methyl Ethyl Ketone Peroxide (>60%)	1338-23-4	5000
Methyl Fluoroacetate	453-18-9	100

Chemical name	CAS*	TQ**
Methyl Fluorosulfate	421-20-5	100
Methyl Hydrazine	60-34-4	100
Methyl Iodide	74-88-4	7500
Methyl Isocyanate	624-83-9	250
Methyl Mercaptan	74-93-1	5000
Methyl Vinyl Ketone	79-84-4	100
Methyltrichlorosilane	75-79-6	500
Nickel Carbonyl (Nickel Tetracarbonyl)	13463-39-3	150
Nitric Acid (>94.5% w/w)	7697-37-2	500
Nitric Oxide	10102-43-9	250
Nitroaniline (para Nitroaniline)	100-01-6	5000
Nitromethane	75-52-5	2500
Nitrogen Dioxide	10102-44-0	250
Nitrogen Oxides (NO; NO <sub>2</sub> ; N <sub>2</sub> O <sub>4</sub> ; N <sub>2</sub> O <sub>3</sub> )	10102-44-0	250
Nitrogen Tetroxide (Nitrogen Peroxide)	10544-72-6	250
Nitrogen Trifluoride	7783-54-2	5000
Nitrogen Trioxide	10544-73-7	250
Oleum (65% to 80% w/w)	8014-95-7	1000
Osmium Tetroxide	20816-12-0	100
Oxygen Difluoride (Fluorine Monoxide)	7783-41-7	100
Ozone	10028-15-6	100
Pentaborane	19624-22-7	100
Peracetic Acid (Peroxyacetic Acid)	79-21-0	1000
Perchloric Acid (>60% w/w)	7601-90-3	5000
Perchloromethyl Mercaptan	594-42-3	150
Perchloryl Fluoride	7616-94-6	5000
Peroxyacetic Acid (Peracetic Acid)	79-21-0	1000
Phosgene (Carbonyl Chloride)	75-44-5	100
Phosphine (Hydrogen Phosphide)	7803-51-2	100
Phosphorus Oxychloride (Phosphoryl Chloride)	10025-87-3	1000
Phosphorus Trichloride	7719-12-2	1000
Phosphoryl Chloride (Phosphorus Oxychloride)	10025-87-3	1000
Propargyl Bromide	106-96-7	100
Propyl Nitrate	627-3-4	2500
Sarin	107-44-8	100
Selenium Hexafluoride	7783-79-1	1000
Stibine (Antimony Hydride)	7803-52-3	500
Sulfur Dioxide (liquid)	7446-09-5	1000
Sulfur Pentafluoride	5714-22-7	250
Sulfur Tetrafluoride	7783-60-0	250
Sulfur Trioxide (Sulfuric Anhydride)	7446-11-9	1000

Table Cont.

Chemical name	CAS*	TQ**
Sulfuric Anhydride (Sulfur Trioxide)	7446-11-9	1000
Tellurium Hexafluoride	7783-80-4	250
Tetrafluoroethylene	116-14-3	5000
Tetrafluorohydrazine	10036-47-2	5000
Tetramethyl Lead	75-74-1	1000
Thionyl Chloride	7719-09-7	250

Chemical name	CAS*	TQ**
Trichloro (chloromethyl) Silane	1558-25-4	100
Trichloro (dichlorophenyl) Silane	27137-85-5	2500
Trichlorosilane	10025-78-2	5000
Trifluorochloroethylene	79-38-9	10000
Trimethoxysilane	2487-90-3	1500

\*Chemical Abstract Service Number.

\*\*Threshold Quantity in Pounds.



# Hazardous Waste

A waste is considered to be characteristically hazardous if it fits any of the following generic criteria:

- *Ignitability.* A waste is considered ignitable if it presents a fire hazard during routine management. A waste is considered ignitable if it is a liquid and has a flash point less than 140 °F; if it is not a liquid and capable of causing fire through friction, absorption of moisture, and spontaneous chemical changes, and when ignited, burns so vigorously that it creates a hazard; or if it is an ignitable compressed gas or an oxidizer. Examples of ignitable wastes include acetone, isopropanol, hexane, and methanol.
- *Corrosivity.* A waste is considered corrosive if it is able to deteriorate standard containers, damage human tissue, and/or dissolve toxic components of other wastes. An aqueous waste is considered corrosive if it has a pH less than or equal to 2 or greater than or equal to 12.5. A non-aqueous liquid is corrosive if it corrodes SAE 1020 steel at a rate greater than 0.25 inches per year at a temperature of 130 °F. Although there is no provision for corrosivity of solids, many states require that a sample be placed in distilled water and the resulting pH be measured. Examples of corrosive wastes include sodium hydroxide, potassium hydroxide, and acids.
- *Reactivity.* A waste is considered reactive if it has a tendency to become chemically unstable under normal management conditions or reacts violently when exposed to air or mixed with water, or if it can generate toxic gases. Specific regulatory definitions for reactivity have not been developed. Examples of reactive wastes include cyanide or sulfide solutions, water-reactive metals, and picric acid.
- *Toxicity.* A waste is considered toxic if it can leach toxic components in excess of specified regulatory levels upon contact with water. The test procedure to be used, called *toxicity characteristic leaching procedure* (TCLP), is carefully specified under the regulations and is very expensive to conduct.





# Heat Capacity

The *heat capacity* of a system is the amount of heat (usually expressed in calories, kilocalories, or joules) needed to raise the system's temperature by one degree (usually expressed in degrees Celsius or degrees Kelvin). It is expressed in units of thermal energy per degree temperature. To aid in the analysis of systems having certain specific dimensions, *molar heat capacity* and *specific heat capacity* are used. To measure the heat capacity of a reaction, a calorimeter must be used. Bomb calorimeters are used for constant volume heat capacities, although a coffee-cup calorimeter is sufficient for a constant pressure heat capacity.

## *Molar Heat Capacity*

The molar heat capacity is the amount of heat needed to increase the temperature of one mole of a substance by one degree (Table). It is expressed in joules per moles per degrees Celsius (or degrees Kelvin).

## *Specific Heat Capacity*

The specific heat capacity is the amount of heat needed to increase the temperature of one gram of a substance by one degree. It is expressed in joules per gram per degree Celsius.

## *Quantity of Heat*

The quantity of heat is a measurement of the amount of heat that is present. The formula of quantity of heat,  $q$ , is equal to the mass of substance,  $m$ , multiplied with the specific heat and the change in temperature,  $\Delta T$ . When the mass of substance is multiplied with the specific heat the product is equal to heat capacity, which is denoted as  $C$ .

$$q = \Delta T \times C \times m$$

The heat capacity,  $C$ , can never be negative for a mass or a substance and the specific heat of a substance can never be

negative. Thus, if the change in temperature is negative, the initial temperature is more than the final temperature, then quantity of heat must be negative, for a negative number multiplied by a positive number equals a negative number. When the quantity of heat is negative the system is depleted of its heat; however, if the quantity of heat is positive then the system gains heat.

The total heat in a closed system must remain constant, which is represented by the equation:

$$q_{\text{system}} + q_{\text{surroundings}} = 0$$

Thus, it is possible to set the quantity of heat of the system equal to the quantity of heat of the surroundings multiplied by negative one.

## *Specific Latent Heat*

The specific latent heat of vaporization is the quantity of heat energy that is necessary to raise one unit of weight (pounds or grams) with no change of temperature in the surroundings. As the name implies, this specific latent heat quantifies the transfer of energy when a substance's state changes from liquid to gas or from gas to liquid. On the other hand, the specific heat of fusion is the quantity of heat that is necessary to raise one unit of weight without any change in temperature. This specific latent heat quantifies the transfer of energy when a substance's state changes from a solid to a liquid or from a liquid to a solid. Two formulas have been derived from this property:

$$q = m \times L$$

$$L = q/m$$

In the equations  $q$  is the amount of heat increase or decrease as the state changes,  $m$  is the mass of the substance present, and  $L$  is the specific latent heat for that substance.

**Table** Molar heat capacity of gases\*.

Gas	Symbol	$C_p$	$C_v$	$C_p/C_v$
				$\gamma$
Ammonia	NH <sub>3</sub>	8.63	6.57	1.31
Argon	A	4.97	2.98	1.67
Methane	CH <sub>4</sub>	8.60	6.59	1.31
Ethane	C <sub>2</sub> H <sub>6</sub>	12.71	10.65	1.19
Dimethyl ether	CH <sub>3</sub> OCH <sub>3</sub>	15.89	13.73	1.16
Carbon dioxide	CO <sub>2</sub>	8.96	6.92	1.29
Carbon monoxide	CO	6.97	4.97	1.40
Chlorine	Cl <sub>2</sub>	3.25	6.14	1.34
Helium	He	4.97	2.98	1.67
Hydrogen	H <sub>2</sub>	6.90	4.91	1.41
Hydrogen chloride	HCl	7.05	5.01	1.41
Nitric oxide	NO	7.11	5.11	1.39
Nitrogen	N <sub>2</sub>	6.94	4.95	1.40
Nitrous oxide	N <sub>2</sub> O	9.33	7.29	1.28
Oxygen	O <sub>2</sub>	7.05	5.05	1.40
Sulfur dioxide	SO <sub>2</sub>	9.40	7.30	1.29

\*Calories deg<sup>-1</sup> mole<sup>-1</sup> at 25 °C $C_p$ : heat capacity at constant pressure $C_v$ : heat capacity at constant pressure

## Heat Content of Petroleum Products

Product	MMBtu/bbl
Crude oil	5.8
Natural gas plant liquids	3.735
Asphalt	6.636
Aviation gasoline	5.048
Butane	4.326
Butane-propane (60/40) mixture	4.13
Distillate fuel oil	5.825
Ethane	3.082
Ethane-propane (70/30) mixture	3.308
Isobutane	3.974
Jet fuel, kerosene-type	5.67
Jet fuel, naphtha-type	5.355
Kerosene	5.67

Product	MMBtu/bbl
Lubricants	6.065
Motor gasoline, oxygenated or reformulated	5.15
Motor gasoline	3.539
Naphtha <401 °F	5.248
Natural gasoline	4.62
Pentanes plus	4.62
Petroleum coke	6.024
Plant condensate	5.418
Propane	3.836
Residual fuel oil	6.287
Road oil	6.636
Still gas	6.000
Waxes	5.537



# Heat Exchangers

Heat exchangers transfer heat from one working fluid to another. For instance, steam generators, feedwater heaters, reheaters and condensers are all examples of heat exchangers found in nuclear power systems. The heat transfer rate across a heat exchanger is usually expressed in the form:

$$Q = UA\Delta T_m$$

$Q$  is the heat transfer rate,  $U$  is the overall heat transfer coefficient,  $A$  is the heat exchanger area, and  $\Delta T_m$  is the average temperature difference between the fluids.

However, heat exchangers exist in three primary forms: (1) parallel flow heat exchangers, (2) counter-flow heat exchangers and (3) cross-flow heat exchangers. Classifications of heat exchangers are according to their flow arrangement.

In *parallel-flow* heat exchangers, the two fluids enter the exchanger at the same end, and travel in parallel to one another to the other side. In *counter-flow* heat exchangers the fluids enter the exchanger from opposite ends. The counter-current design is the most efficient, in that it can transfer the most heat from the heat (transfer) medium per unit mass due to the fact that the average temperature difference along any unit length is *higher*. In a *cross-flow* heat exchanger, the fluids travel roughly perpendicular to one another through the exchanger.

Heat exchangers are designed to maximize the surface area of the wall between the two fluids, while minimizing resistance to fluid flow through the exchanger. The exchanger's performance can also be affected by the addition of fins or corrugations in one or both directions, which increase surface area and may channel fluid flow or induce turbulence.

Direct contact heat exchangers involve heat transfer between hot and cold streams of two phases in the absence

of a separating wall. Thus such heat exchangers can be classified as: (1) gas-liquid, (2) immiscible liquid-liquid, and (3) solid-liquid or solid-gas. Most direct contact heat exchangers fall under the gas-liquid category, where heat is transferred between a gas and liquid in the form of drops, films or sprays. In the petroleum and natural gas industry, these types of heat exchangers are used predominantly in liquid heating, water cooling and condensing.

For an adiabatic heat exchanger (no heat transferred with environment), there are three equations for  $Q$ , i.e., the rate of heat exchange between the two process streams:

$$Q = N_{ps}(H_{ps,in} - H_{ps,out}) \text{ (heat transferred from process stream)}$$

$$Q = N_{us}(H_{us,out} - H_{us,in}) \text{ (heat transferred to utility stream)}$$

$$Q = UAF\Delta T_{avg} \text{ (rate of heat transfer; actually defining } U)$$

$Q$  is the rate of heat exchange (e.g., in kJ/h),  $N_i$  is the flow-rate of stream  $i$  (e.g, in kmol/h),  $H_i$  is the specific enthalpy of stream  $i$  (kJ/kmol),  $U$  is the overall heat transfer coefficient (kJ/m<sup>2</sup>.K),  $A$  is the heat exchange area (m<sup>2</sup>),  $F$  is the correction factor for the deviation from cocurrent or countercurrent flow,  $\Delta T_{avg}$  is the average temperature difference between the streams for true cocurrent or countercurrent flow.

If both streams exchange either latent heat or sensible heat, but not both, then:

$$\Delta T_{avg} = \Delta T_{lm} \equiv \frac{\Delta T_{end1} - \Delta T_{end2}}{\ln \Delta T_{end1} - \ln \Delta T_{end2}}$$

for both cocurrent and countercurrent flow, where:  $\Delta T_{end1}$  is the temperature difference between the two streams at end 1 of the column (K),  $\Delta T_{end2}$  is the temperature difference between the two streams at the end 2 of the column (K). Either end of the heat exchanger can be designated as 1 or 2.

Various types of gas-liquid heat exchangers used in the petroleum and natural gas industries.

Phase	Continuous phase	Driving force	Change of phase	Examples
Gas-liquid	Gas	Gravity	No	Spray columns, packed columns
			Yes	Cooling towers, falling droplet evaporators
		Forced	No	Spray coolers/quenchers
		Liquid flow	Yes	Spray condensers/evaporation
	Liquid	Gravity	No	Bubble columns, perforated tray columns
			Yes	Bubble column condensers
		Forced	No	Gas spargers
		Gas flow	Yes	Direct contact evaporators

# Heat of Combustion of Petroleum Fuels

The *heat value* (hmv) of petroleum products is determined by combustion in a bomb with oxygen under pressure (ASTM D240). It may also be calculated, in products free from impurities, by the formula

$$Q_v = 22,320 - 3,780d^2$$

in which  $Q_v$  is the hmv at constant volume in Btu/lb and  $d$  is the specific gravity at 60/60 °F.

The low heat value at constant pressure  $Q_p$  may be calculated by the relation

$$Q_p = Q_v - 90.8H$$

where  $H$  is the weight percentage of hydrogen and can be obtained from the relation

$$H = 26 - 15d$$

Typical heats of combustion of petroleum oils free from water, ash, and sulfur vary (within an estimated accuracy of 1%) with the API gravity (i.e., with the “heaviness” or “lightness” of the material).

The heat value should be corrected when the oil contains sulfur by using an hmv of 4050 Btu/lb for sulfur (ASTM D1405).

The *specific heat*  $c$  of petroleum products of specific gravity  $d$  and at temperature  $t$  (°F) is given by the equation

$$c = (0.388 + 0.00045t) / \sqrt{d}$$

The *heat of vaporization*  $L$  (Btu/lb) may be calculated from the equation

$$L = (110.9 - 0.09t) / d$$

The heat of vaporization per gallon (measured at 60 °F) is

$$8.34Ld = 925 - 0.75t$$

indicating that the heat of vapourization per gallon depends only on the temperature of vapourization  $t$  and varies over the range of 450 for the heavier products to 715 for gasoline. These data have an estimated accuracy within 10% when the vaporization is at constant temperature and at pressures below 50 lb/in<sup>2</sup> without chemical change.





# Heat of Combustion of Petroleum Fuels

The *heat value* (hmv) of petroleum products is determined by combustion in a bomb with oxygen under pressure (ASTM D240). It may also be calculated, in products free from impurities, by the formula

$$Q_v = 22,320 - 3,780d^2$$

in which  $Q_v$  is the hmv at constant volume in Btu/lb and  $d$  is the specific gravity at 60/60 °F.

The low heat value at constant pressure  $Q_p$  may be calculated by the relation

$$Q_p = Q_v - 90.8H$$

where  $H$  is the weight percentage of hydrogen and can be obtained from the relation

$$H = 26 - 15d$$

Typical heats of combustion of petroleum oils free from water, ash, and sulfur vary (within an estimated accuracy of 1%) with the API gravity (i.e., with the “heaviness” or “lightness” of the material).

The heat value should be corrected when the oil contains sulfur by using an hmv of 4050 Btu/lb for sulfur (ASTM D1405).

The *specific heat*  $c$  of petroleum products of specific gravity  $d$  and at temperature  $t$  (°F) is given by the equation

$$c = (0.388 + 0.00045t) / \sqrt{d}$$

The *heat of vaporization*  $L$  (Btu/lb) may be calculated from the equation

$$L = (110.9 - 0.09t) / d$$

The heat of vaporization per gallon (measured at 60 °F) is

$$8.34Ld = 925 - 0.75t$$

indicating that the heat of vapourization per gallon depends only on the temperature of vapourization  $t$  and varies over the range of 450 for the heavier products to 715 for gasoline. These data have an estimated accuracy within 10% when the vaporization is at constant temperature and at pressures below 50 lb/in<sup>2</sup> without chemical change.



# Heat Transfer Coefficient

Heat exchangers transfer heat from one working fluid to another. For instance, steam generators, feedwater heaters, reheaters and condensers are all examples of heat exchangers found in nuclear power systems. The heat transfer rate across a heat exchanger is usually expressed in the form:

$$Q = U A \Delta T_{tot}$$

$U$  is the overall heat transfer coefficient and is equal given as: to  $\text{Btu}/(\text{h ft}^2 \text{ }^\circ\text{F})$ ,  $\Delta T_{tot}$  is the total temperature difference (overall driving force for the process), and  $A$  is the heat exchanger area, i.e., the inside area or outside area of the pipe.

During the operation, the heat transfer surfaces of a heat exchanger may become coated with deposits from the heat transfer fluids or corrosion. In either case, the additional resistance to heat transfer due to these materials decreases the performance of the heat exchanger and must be accounted for by the use of experimentally determined fouling factors. Thus:

$$R_f = 1/U' - 1/U$$

where:  $R_f$  is the fouling factor  $U'$  is the overall heat transfer coefficient for the fouled heat exchanger, and  $U$  is the overall heat transfer coefficient for the clean heat exchanger.

Fouling factors for some common fluids.

Type of fluid	Fouling factor (hr-ft <sup>2</sup> -F/Btu)
Sea water below 125 °F	0.0005
Sea water above 125 °F	0.001
Treated boiler feedwater above 125 °F	0.001
Fuel oil	0.005
Quenching oil	0.004
Alcohol vapors	0.0005
Steam, non-oil bearing	0.0005
Industrial air	0.002
Refrigerating liquid	0.001



# Heat Transfer – Convection and Conduction

In a body of fluid that is heated from underneath its container, conduction and convection can be considered to compete for dominance. If heat conduction is too great, fluid moving down by convection is heated by conduction so fast that its downward movement will be stopped due to buoyancy, while fluid moving up by convection is cooled by conduction so fast that its driving buoyancy will diminish. On the other hand, if heat conduction is very low, a large temperature gradient may be formed and convection might be very strong.

The Rayleigh number ( $R_a$ ) is a measure determining the relative strength of conduction and convection:

$$R_a = (g\Delta\rho L^3)/\mu\alpha = (g\beta \Delta T L^3)/\nu\alpha$$

where  $g$  is acceleration due to gravity,  $\rho$  is the density,  $\Delta\rho$  is the density difference between the lower and upper ends,  $\mu$  is the dynamic viscosity,  $\alpha$  is the thermal diffusivity,  $\beta$  is the volume thermal expansivity,  $T$  is the temperature,  $\nu$  is the kinematic viscosity, and  $L$  is characteristic length.

The buoyancy force driving the convection is approximately  $g\Delta\rho L^3$  so the corresponding pressure is  $g\Delta\rho L$ . Convection occurs when the Rayleigh number is above 1,000–2,000.



# Heating Value

The heating value (energy value, calorific value) of a fuel is the amount of heat released during the combustion of a specified amount of the fuel and is a specific characteristic for each fuel. It is measured in units of energy per unit of the substance, usually mass (such as: Btu/lb, kJ/kg, kJ/mol, kcal/kg) or, in the case of gaseous fuels, by volume (Btu per standard cubic foot, Btu/scf). Heating value unit conversions are:

- $\text{Btu/lb} = \text{kcal/kg} \times 1.8$
- $\text{kJ/kg} = \text{Btu/lb} \times 2.326$
- $\text{kcal/kg} = \text{MJ/kg} \times 238.846$

Gaseous fuels HHV,	Btu/scf
Natural gas	900–1,300
Refinery off gas	1,100–2,000

Liquid fuels HHV	Btu/gallon
Heavy crude oil (14° API)	150,000
Light crude (30° API)	140,000
Fuel Oil – No. 1	137,400
Fuel Oil – No. 2	139,600
Fuel Oil – No. 3	141,800
Fuel Oil – No. 4	145,100
Fuel Oil – No. 5	148,800
Fuel Oil – No. 6	152,400
Kerosene (45° API)	159,000
Gasoline (60° API)	150,000
Naphtha (65° API)	115,000





# Heavy Feedstock Conversion – Thermal Processes

Thermal processes are processes that decompose, rearrange, or combine hydrocarbon molecules by the application of heat. The major variables involved are feedstock type, time, temperature, and pressure and, as such, are usually considered in promoting cracking (thermal decomposition) of the heavier molecules to lighter products and in

minimizing coke formation. Thus, one of the earliest processes (*thermal cracking*) used in the petroleum industry is the non-catalytic conversion of higher boiling petroleum stocks into lower boiling products. This has been followed by the development of processes such as visbreaking, delayed coking, and fluid coking (Table).

**Table** Visbreaking, delayed coking, and fluid coking.

<b>Thermal Cracking</b>
Purpose: to produce volatile products of low-volatile or non-volatile feedstocks
Conversion was the prime purpose
Cracking with simultaneous removal of distillate (semi-continuous)
Batch cracking (non-continuous)
High conversion
Process configuration: various
<b>Visbreaking</b>
Purpose: to reduce viscosity of fuel oil to acceptable levels
Conversion is not a prime purpose
Mild (470 to 495 °C; 880 to 920 °F) heating at pressures of 50 to 200 psi
Reactions quenched before going to completion
Low conversion (10%) to products boiling less than 220 °C (430 °F)
Heated coil or drum (soaker)
<b>Delayed Coking</b>
Purpose: to produce maximum yields of distillate products
Moderate (480 to 515 °C; 900 to 960 °F) heating at pressures of 90 psi
Reactions allowed to proceed to completion
Complete conversion of the feedstock
Soak drums (845 to 900 °F) used in pairs (one on stream and one off stream being de-coked)
Coked until drum solid

(Continued)

**Table** Cont.

Coke removed hydraulically from off-stream drum
Coke yield: 20–40% by weight (dependent upon feedstock)
Yield of distillate boiling below 220 °C (430 °F): ca. 30% (but feedstock dependent)
<b>Fluid Coking</b>
Purpose: to produce maximum yields of distillate products
Severe (480 to 565 °C; 900 to 1050 °F) heating at pressures of 10 psi
Reactions allowed to proceed to completion
Complete conversion of the feedstock
Oil contacts refractory coke
Bed fluidized with steam; heat dissipated throughout the fluid bed
Higher yields of light ends (<C <sub>5</sub> ) than delayed coking
Less coke yield than delayed coking (for one particular feedstock)

# Heterogeneity

Heterogeneity is the term applied to a lack of uniformity in reservoir properties such as permeability. Reservoir heterogeneity is a function of the porosity/permeability distribution due to lithologic variation during sedimentary deposition, which is further complicated by mechanical processes related to deformation and chemical processes associated with diagenesis. Fluid flow in reservoirs is affected by heterogeneity at a range of scales but the predominant control is exerted by bedding, pore fluid changes, and diagenetic effects at the meter-scale.

Structural styles and facies architecture are the two fundamental elements that define the reservoir heterogeneity,

and eventually determine the capability that either foster or hinder fluid drainage. Heterogeneity is linked to evolution of reservoir facies under varied depositional environments, structural styles present at the time of deposition and changes brought in due to post-depositional tectonic activities. These episodes are instrumental in imparting the vertical-lateral heterogeneity within the reservoir.

Reservoir heterogeneity can result in significant bypassed hydrocarbons if the geometry and architecture of the channel bodies are incorrectly identified and not correlated within a rigorous sequence stratigraphic framework.



# Heterogeneous Catalysis and Homogeneous Catalysis

*Heterogeneous* catalysts are distinguished from *homogeneous* catalysts by the different phases present during reaction. Homogeneous catalysts are present in the same phase as reactants and products, usually liquid, while heterogeneous catalysts are present in a different phase, usually solid. The main advantage of using a heterogeneous catalyst is the relative ease of catalyst separation from the product stream that aids in the creation of continuous chemical processes. Additionally, heterogeneous catalysts are typically more tolerant of extreme operating conditions than their homogeneous analogs.

A heterogeneous catalytic reaction involves adsorption of reactants from a fluid phase onto a solid surface, surface reaction of adsorbed species, and desorption of products into the fluid phase. The presence of a catalyst provides an alternative sequence of elementary steps to accomplish the desired chemical reaction from that in its absence. If the energy barriers of the catalytic path are much lower than the barrier(s) of the non-catalytic path, significant enhancements in the reaction rate can be realized by use of a catalyst.



# High-Acid Crudes

High-acid crude oils (Table) are crude oils that contain considerable proportions of naphthenic acids which, as commonly used in the petroleum industry, refers collectively to all of the organic acids present in the crude oil. In many instances, the high-acid crude oils are actually the heavier, more viscous crude oils. The total acid matrix is therefore complex and it is unlikely that a simple titration, such as the traditional methods for measurement of the total acid number, can give meaningful results to use in predictions of problems. An alternative way of defining the relative organic acid fraction of crude oils is therefore a real need in the oil industry, both upstream and downstream.

The acidity of crude oil or a crude oil product is measured as the *total acid number* (TAN), which is determined by the amount of potassium hydroxide in milligrams that is needed to neutralize the acidic species in one gram of oil (Table 2).

High-acid crude oils cause corrosion in the refinery – corrosion is predominant at temperatures in excess of 180 °C (355 °F) and occurs particularly in the atmospheric distillation unit (the first point of entry of the high-acid crude oil) and also in the vacuum distillation units (Figure). In addition, overhead corrosion is caused by the mineral salts, magnesium, calcium and sodium chloride which are hydrolyzed to produce volatile hydrochloric acid, causing a highly corrosive condition in the overhead exchangers. Therefore, these salts present a significant contamination in opportunity crude oils. Other contaminants in opportunity crude oils which are shown

to accelerate the hydrolysis reactions are inorganic clays and organic acids.

**Table 1** High-acid crudes available to various markets.

Source	Crude
North West Europe	Alba
	Captain
	Clair
	Grane
	Gryphon
	Harding
	Heidrun
	Leadon
	Troll Blend
South America	Marlim
	Roncador
	Venezuelan blends
West Africa	Ceiba
	Benguela heavy
	Dalia
	Kome
	Kuito
	Lokele
Rosalita	

**Table 2** Comments on testing for naphthenic acids.

ORIGIN: Naphthenic acids are naturally chemical species occurring in some crude oils.
EFFECTS: Naphthenic acids may cause operational problems such as foaming in the desalter or other units.
MEASUREMENT UNITS: Naphthenic acids are measured as mg of KOH/gram of crude oil.
DESIRED LEVELS: The desired level of naphthenic acids in the crude oil is less than 0.05 mg of KOH/gram of oil.
DEGREE OF ACCURACY: The acid content of a crude oil may be determined to $\pm 0.02$ mg KOH/gram of oil, which includes species other than naphthenic acids.

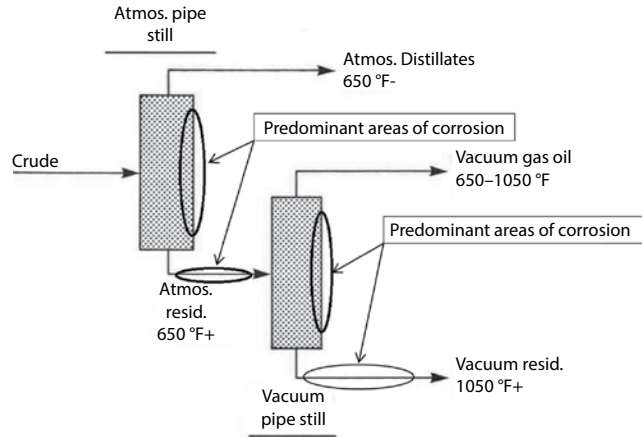

**Figure** Atmospheric and vacuum distillation units showing the predominant areas of naphthenic acid corrosion.



# Hydrate Formation and Prevention

## *Formation*

Natural gas hydrates are ice-like structures in which gas, most often methane, is trapped inside of water molecules. Chemically, gas hydrates are clathrate physical compounds, in which the molecules of gas are occluded in crystalline cells, consisting of water molecules retained by the energy of hydrogen bonds. All gases can form hydrates under different pressures and temperatures. Examples of chemical formula for gas hydrates are: (1) methane:  $\text{CH}_4 \cdot 7\text{H}_2\text{O}$ , (2) ethane:  $\text{C}_2\text{H}_6 \cdot 8\text{H}_2\text{O}$ , and (3) propane:  $\text{C}_3\text{H}_8 \cdot 18\text{H}_2\text{O}$ . The crystalline structure of solid gas hydrate crystals has a strong dependence on gas composition, pressure, and temperature. Gas hydrates are in fact highly flammable, a property that makes these crystalline structures both an attractive future energy source as well as a potential hazard.

Gas hydrates (especially methane hydrate) are commonly formed during natural gas production operations, when liquid water is condensed in the presence of methane at high pressure. It is known that larger hydrocarbon molecules like ethane and propane can also form hydrates, although longer molecules (butanes, pentanes) cannot fit into the water cage structure and tend to destabilize the formation of the hydrates.

When drilling in oil-bearing and in gas-bearing formations submerged in deep water, the reservoir gas may flow into the well bore and form gas hydrates owing to the low temperatures and high pressures found during deep water drilling. The gas hydrates may then flow upward with drilling mud or other discharged fluids. When the hydrates rise, the pressure in the annulus decreases and the hydrates dissociate into gas and water. The rapid gas expansion ejects fluid from the well, reducing the pressure further, which leads to more hydrate dissociation and further fluid ejection.

Measures which reduce the risk of hydrate formation include:

- High flow-rates, which limit the time for hydrate formation in a volume of fluid, thereby reducing the kick potential.
- Careful measuring of line flow to detect incipient hydrate plugging.
- Additional care in measuring when gas production rates are low and the possibility of hydrate formation is higher than at relatively high gas flow rates.
- Monitoring of well casing after it is “shut in” (isolated) may indicate hydrate formation. Following “shut in”, the pressure rises while gas diffuses through the reservoir to the bore hole; the rate of pressure rise exhibits a reduced rate of increase while hydrates are forming.
- Additions of energy (e.g., the energy released by setting cement used in well completion) can raise the temperature and convert hydrates to gas.

## *Prevention*

Hydrates are generally then removed by reducing the pressure, heating them, or dissolving them by chemical means. Care must be taken to ensure that the removal of the hydrates is carefully controlled, because of the potential for the hydrate to undergo a phase transition from the solid hydrate to release water and gaseous methane at a high rate when the pressure is reduced. The rapid release of methane gas in a closed system can result in a rapid increase in pressure.

It is generally preferable to prevent hydrates from forming or blocking equipment. This is commonly achieved by removing water, or by the addition of ethylene glycol ( $\text{HOCH}_2\text{CH}_2\text{OH}$ ) or methyl alcohol (methanol), which act to depress the temperature at which hydrates will form. In

recent years, development of other forms of hydrate inhibitors have been developed, such as *kinetic hydrate inhibitors* (which by far slow the rate of hydrate formation) and anti-agglomerates, which do not prevent hydrates forming, but do prevent them sticking together to block equipment.

The amount of chemical inhibitor required to treat the water in order to lower the hydrate formation temperature may be calculated from the Hammerschmidt equation:

$$\Delta T = (KW) / [M(100 - W)]$$

In this equation,  $\Delta T$  is the depression in hydrate formation temperature ( $^{\circ}\text{F}$ ),  $W$  is the weight percent of

the inhibitor for water treatment,  $K$  is a constant that depends on the type of inhibitor (Table 2), and  $M$  is the molecular weight of the inhibitor.

**Table** K values for methanol and selected glycols.

Alcohol/glycol	Molecular weight	K
Methanol	32.04	2335
Ethylene glycol	62.07	2200
Propylene glycol	76.10	3590
Diethylene glycol	106.10	4370

# Hydraulic Fracturing

Hydraulic fracturing is a widely used technique for production enhancement which involves the creation of a crack in the reservoir by injecting highly pressurized fluids at a very high rate. The fluids are solutions of polymers, which are used to thicken the carrier fluid, often water, for the purpose of increasing its viscosity and allowing it to carry particles, called proppants. The hydraulically created fracture is held open (propped) with tens of thousands to millions of pounds of clean, uniform natural sand or synthetic materials, and can have a permeability that is orders of magnitude larger than the surrounding reservoir.

**Table 1** Proppant type definition.

Sand	Includes all raw sand types.
Resin-coated sand	Includes only resin-coated proppants for which the substrate is sand; does not include any double-counting with the “Sand category” described above.
Ceramic	Any proppant for which the substrate is a ceramic or otherwise manufactured proppant, resin-coated ceramic proppant is included in this category.

**Table 2** Additives used in the hydraulic fracturing process.

Water and Sand: Approximately 98% v/v			
Water	Expand the fracture and delivers sand	Some stays in the formation while the remainder returns with natural formation water as produced water (actual amounts returned vary from well to well)	Landscaping and manufacturing
Sand (Proppant)	Allows the fractures to remain open so that the oil and natural gas can escape	Stays in the formation, embedded in the fractures (used to “prop” fractures open)	Drinking water filtration, play sand, concrete and brick mortar
Other Additives: ~2%			
Acid	Helps dissolve minerals and initiate cracks in the rock	Reacts with the minerals present in the formation to create salts, water and carbon dioxide (neutralized)	Swimming pool chemicals and cleaners
Anti-bacterial Agent	Eliminates bacteria in the water that produces corrosive by-products	Reacts with micro-organisms that may be present in the treatment fluid and formation; these micro-organisms break down the product with a small amount returning to the surface in the produced water	Disinfectant; sterilizer for medical and dental equipment
Breaker	Allows a delayed breakdown of the gel	Reacts with the crosslinker and gel in the formation making it easier for the fluid to flow to the borehole; this reaction produces ammonia and sulfate salts, which are returned to the surface in the produced water	Hair colorings, as a disinfectant and in the manufacture of common household plastics

(Continued)

Table 2 Cont.

Clay Stabilizer	Prevents formation clays from swelling	Reacts with clays in the formation through a sodium–potassium ion exchange; this reaction results in sodium chloride (table salt), which is returned to the surface in the produced water	Low-sodium table salt substitutes, medicines, and IV fluids
Corrosion Inhibitor	Prevents corrosion of the pipe	Bonds to the metal surfaces, such as pipe, downhole; any remaining product that is not bonded is broken down by micro-organisms and consumed or returned to the surface in the produced water	Pharmaceuticals, acrylic fibers and plastics
Crosslinker	Maintains fluid viscosity as temperature increases	Combines with the “breaker” in the formation to create salts that are returned to the surface in produced water	Laundry detergents, hand soaps and cosmetics
Friction Reducer	Minimizes friction	Remains in the formation where temperature and exposure to the breaker allows it to be broken down and consumed by naturally occurring micro-organisms; a small amount returns to the surface with the produced water	Cosmetics including hair, make-up, nail and skin products
Gelling Agent	Thickens the water to suspend the sand	Combines with the breaker in the formation making it easier for the fluid to flow to the borehole and return to the surface in the produced water	Cosmetics, baked goods, ice cream, toothpastes, sauces and salad dressings
Iron Control	Prevents precipitation of metal in pipe	Reacts with minerals in the formation to create simple salts, carbon dioxide and water, all of which are returned to the surface in the produced water	Food additives; food and beverages; lemon juice
Non-emulsifier	Breaks or separates oil/water mixtures (emulsions)	Generally, returns to the surface with produced water, but in some formations it may enter the gas stream and return to the surface in the produced oil and natural gas	Food and beverage processing, pharmaceuticals, and wastewater treatment
pH Adjusting Agent	Maintains the effectiveness of other components, such as crosslinkers	Reacts with acidic agents in the treatment fluid to maintain a neutral (non-acidic, non-alkaline) pH; this reaction results in mineral salts, water and carbon dioxide – a portion of each is returned to the surface in the produced water	Laundry detergents, soap, water softeners and dish washer detergents

## Hydrocarbon Gases – Physical Constants

The number of carbon atoms in a member of the paraffin series determines whether the hydrocarbon will exist as a gas, a liquid, or a solid under standard conditions of temperature and pressure (STP' 60 °F, 760 mm Hg). Methane (CH<sub>4</sub>) is a gas under all naturally occurring temperature and pressure conditions. Ethane (C<sub>2</sub>H<sub>6</sub>), propane (C<sub>3</sub>H<sub>8</sub>), butane (C<sub>4</sub>H<sub>10</sub>) and its isomers are gaseous under standard surface conditions (Table) but may exist in either gaseous or liquid phase under the elevated temperature and pressure conditions found in subsurface reservoirs.

On the other hand, members of the paraffin series with between 5 and 17 carbon atoms in their molecular structures (such as pentane, C<sub>5</sub>H<sub>12</sub>, hexane, C<sub>6</sub>H<sub>14</sub>, heptane, C<sub>7</sub>H<sub>16</sub>, octane, C<sub>8</sub>H<sub>18</sub>) are liquid under standard surface conditions and most temperature and pressure conditions encountered in subsurface reservoirs. Members of the paraffin series with more than 17 carbon atoms are solid under most naturally occurring temperatures and pressures and when isolated from crude oil form the mixture known as paraffin wax.

**Table 1** Properties of gaseous (C<sub>1</sub>–C<sub>4</sub>) paraffin hydrocarbons.

Gas	Molecular weight	Boiling point 1 atm, °C (°F)	Density at 60 °F g/liter	Density Relative to air = 1
Methane	16.043	-161.5 (-258.7)	0.6786	0.5547
Ethylene	28.054	-103.7 (-154.7)	1.1949	0.9768
Ethane	30.068	-88.6 (-127.5)	1.2795	1.046
Propylene	42.081	-47.7 (-53.9)	1.8052	1.4757
Propane	44.097	-42.1 (-43.8)	1.8917	1.5464
1,2- Butadiene	54.088	10.9 (51.6)	2.3451	1.9172
1,3-Butadiene	54.088	-4.4 (24.1)	2.3491	1.9203
1-Butene	56.108	-6.3 (20.7)	2.4442	1.9981
cis-2-Butene	56.108	3.7 (38.7)	2.4543	2.0063
trans-2-Butene	56.108	0.9 (33.6)	2.4543	2.0063
iso-Butene	56.104	-6.9 (19.6)	2.4442	1.9981
n-Butane	58.124	-5.4 (31.1)	2.532	2.0698
iso-Butane	58.124	-11.7 (10.9)	2.5268	2.0656

**Table 2** Critical temperature and pressure of hydrocarbon gases compared to non-hydrocarbons.

Component		Molecular weight	Critical pressure (psia)	Constants Temp. (°R)
CH <sub>4</sub>	Methane	16.04	668	343
C <sub>2</sub> H <sub>6</sub>	Ethane	30.07	708	550
C <sub>3</sub> H <sub>8</sub>	Propane	44.10	616	666
i-C <sub>4</sub> H <sub>10</sub>	Isobutane	58.12	529	735
n-C <sub>4</sub> H <sub>10</sub>	Normal butane	58.12	551	765
i-C <sub>5</sub> H <sub>12</sub>	Isopentane	72.15	490	829
n-C <sub>5</sub> H <sub>12</sub>	Normal pentane	72.15	489	845
n-C <sub>6</sub> H <sub>14</sub>	Normal hexane	86.18	437	913
n-C <sub>7</sub> H <sub>14</sub>	Normal heptane	100.20	397	972
n-C <sub>8</sub> H <sub>18</sub>	Normal octane	114.23	361	1024
n-C <sub>9</sub> H <sub>20</sub>	Normal nonane	128.26	332	1070
n-C <sub>10</sub> H <sub>22</sub>	Normal decane	142.29	304	1112
CO <sub>2</sub>	Carbon dioxide	44.01	1071	548
H <sub>2</sub> S	Hydrogen sulphide	34.08	1306	672
N <sub>2</sub>	Nitrogen	28.01	493	227

# Hydroconversion

Hydroconversion is the collective name given to a group of processes in which feedstock are converted to saleable products (Table 1, Table 2). Each process is form of hydrocracking in which hydrogenation and cracking occur simultaneously.

Hydrocracking conversion is usually defined in terms of a change of the end point:

$$\% \text{Conversion} = \left( \frac{(\text{EP}^+)_{\text{feed}} - (\text{EP}^+)_{\text{products}}}{(\text{EP}^+)_{\text{feed}}} \right) \times 100$$

where EP<sup>+</sup> is the fraction of material in the feed or product boiling above the desired end point usually as % w/w or % v/v.

**Table 1** Feedstocks.

Feedstock	Products	Type of process	Impurities removal
Naphtha	Reformer feed	Hydrotreating	S
	LPG	Hydrocracking	
Atmospheric gas oil	Diesel	Hydrotreating	S, aromatics
	Jet fuel	Mild hydrocracking	S, aromatics
	Naphtha	Hydrocracking	
Vacuum gas oil	Low sulphur fuel oil (LSFO)	Hydrotreating	S
	FCC feed	Hydrotreating	S, N, metals
	Diesel	Hydrotreating, Hydrocracking	S, aromatics
	Kerosene/Jet	Hydrotreating	S, aromatics
	Naphtha	Hydrotreating	S, aromatics
	Lube oil	Hydrotreating	S, N, aromatics
Residuum	LSFO	Hydrotreating	S
	FCC feedstock	Hydrotreating	S, N, CCR and metals
	Coker feedstock	Hydrotreating	S, CCR, metals
	Diesel	Hydrocracking	

**Table** Process parameters.

<b>Operating conditions</b>	<b>Hydrotreating</b>	<b>Mild hydrocracking</b>	<b>Hydrocracking</b>
Conversion (%)	–	20–70	70–100
H <sub>2</sub> pressure (bars)	25–51	35–70	85–140
H <sub>2</sub> flow (L/min)	300	300–1000	1000–2000
Temperature (°C)	360–400	350–440	350–450
LHSV (h <sup>-1</sup> )	0.5–2.5	0.3–1.5	0.5–2.0
<i>Catalyst</i>			
Hydrogen transfer	Co/Mo	Ni/Mo	Ni/Mo
(Metal)	Ni/Mo	Co/Mo	Ni/W Pd
Support	Alumina	Alumina	Si–Al
Cracking (acid)	–	Si–Al	Zeolite



# Hydrogen Chloride

**Table** Physical properties of hydrogen chloride.

Molecular weight	36.46
Vapour pressure @ 21 °C	613 psig
Specific volume @ 21 °C, 1 atm	661.7 ml/g
Boiling point @ 1 atm	-85.03 °C
Freezing point @ 1 atm	-114.19 °C
Specific gravity (gas) @ 0 °C, 1 atm	1.268
Density (gas) @ 0 °C, 1 atm	1.639 g/l
Density (liquid) @ -36 °C	1.194 g/l
Critical temperature	51.4 °C
Critical pressure	1198 psia (81.5 atm)
Critical density	0.42 g/ml
Latent heat of vaporization @ bp	103.12 cal/g
Specific heat (gas) @ 15 °C, 1 atm	
$C_p$	0.1939 cal/g °C
$C_v$	0.1375 cal/g °C
ratio $C_p/C_v$	1.41
Viscosity (gas) @ 20 °C, 1 atm	0.0156 cP
Solubility in water @ 0 °C, 1 atm	82.31 g/100 g water



# Hydrogen in Refineries

The use of hydrogen in thermal processes is now an inclusion in most refineries (Table 1, Table 2). Hydrogenation processes for the conversion of petroleum fractions and petroleum products may be classified as *destructive hydrogenation* and *nondestructive hydrogenation*.

*Nondestructive hydrogenation (hydrotreating, simple hydrogenation)* is generally used for the purpose of improving

product quality without appreciable alteration of the boiling range. On the other hand, *destructive hydrogenation (hydrogenolysis, hydrocracking)* is characterized by the conversion of feedstock higher molecular weight constituents to lower-boiling value-added products.

**Table 1** Summary of typical hydrogen application and production process in a refinery.

<i>Hydrogen Applications</i>
Naphtha hydrotreater:
<ul style="list-style-type: none"> <li>• Uses hydrogen to desulfurize naphtha from atmospheric distillation; must hydrotreat the naphtha before sending to a catalytic reformer unit.</li> </ul>
Distillate hydrotreater:
<ul style="list-style-type: none"> <li>• Desulfurizes distillates after atmospheric or vacuum distillation; in some units aromatics are hydrogenated to cycloparaffins or alkanes.</li> </ul>
Hydrodesulfurization:
<ul style="list-style-type: none"> <li>• Sulfur compounds are hydrogenated to hydrogen sulphide H<sub>2</sub>S as feed for Claus plants.</li> </ul>
Hydroisomerization:
<ul style="list-style-type: none"> <li>• Normal (straight-chain) paraffins are converted into iso-paraffins to improve the product properties (e.g., octane number).</li> </ul>
Hydrocracker:
<ul style="list-style-type: none"> <li>• Uses hydrogen to upgrade heavier fractions into lighter, more valuable products.</li> </ul>

<i>Hydrogen Production</i>
Catalytic reformer:
<ul style="list-style-type: none"> <li>• Used to convert the naphtha-boiling range molecules into higher octane reformat; hydrogen is a byproduct.</li> </ul>
Steam-methane reformer:
<ul style="list-style-type: none"> <li>• Produces hydrogen for the hydrotreaters or hydrocracker.</li> </ul>
Steam reforming of higher molecular weight hydrocarbons:
<ul style="list-style-type: none"> <li>• Produces hydrogen from low-boiling hydrocarbons other than methane.</li> </ul>
Recovery from refinery off-gases:
<ul style="list-style-type: none"> <li>• Process gas often contains hydrogen in the range up to 50% v/v.</li> </ul>
Gasification of petroleum residua:
<ul style="list-style-type: none"> <li>• Recovery from synthesis gas (syngas) produced in gasification units.</li> </ul>
Gasification of petroleum coke:
<ul style="list-style-type: none"> <li>• Recovery from synthesis gas (syngas) produced in gasification units.</li> </ul>
Partial oxidation processes:
<ul style="list-style-type: none"> <li>• Analogous to gasification process; produce synthesis gas from which hydrogen can be isolated.</li> </ul>

**Table 2** Hydroprocessing parameters.

<b>Conditions</b>
Solid Acid Catalyst (silica-alumina with rare earth metals, various other options\)
Temperature: 260 to 450 °C (500 to 845 °F (solid/liquid contact)
Pressure: 1,000 to 6,000 psi hydrogen
Frequent catalysts renewal for heavier feedstocks
Gas oil: catalyst life up to three years
Heavy oil/tar sand bitumen: catalyst life less than one year
<b>Feedstocks</b>
Distillates
Refractory (aromatic) streams
Coker oils,
Cycle Oils
Gas oils
Residua (as a full hydrocracking or hydrotreating option)
In some cases, asphaltic constituents (S, N, and metals) removed by deasphalting
<b>Products</b>
Lower molecular weight paraffins
Some methane, ethane, propane, and butane
Hydrocarbon distillates (full range depending on the feedstock)
Residual tar (recycle)
Contaminants (asphaltic constituents) deposited on the catalyst as coke or metals
<b>Variations</b>
Fixed bed (suitable for liquid feedstocks
Ebullating bed (suitable for heavy feedstocks)

# Hydrogen Sulfide Conversion

The disposition of hydrogen sulfide is an issue with many gas processing operations. Burning hydrogen sulfide as a fuel gas component or as a flare gas component is precluded by safety and environmental considerations since one of the combustion products is the highly toxic sulfur dioxide (SO<sub>2</sub>), which is also toxic.

Hydrogen sulfide is typically removed from gas streams through an *olamine* process, after which application of heat regenerates the olamine and forms an acid gas stream (also called the *tail gas* stream). Following from this, the acid gas stream is treated to convert the hydrogen sulfide elemental sulfur and water. The conversion process utilized in most modern refineries is the *Claus process*, or a variant thereof. The Claus process (Figure) involves combustion of approximately one-third of the hydrogen sulfide to sulfur dioxide and then reaction of the sulfur dioxide with the remaining hydrogen sulfide in the presence of a fixed bed of activated alumina, cobalt molybdenum catalyst resulting in the formation of elemental sulfur:

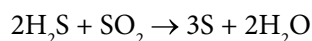
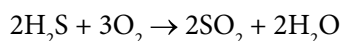

Different process flow configurations are in use to achieve the correct hydrogen sulfide/sulfur dioxide ratio in the conversion reactors.

Overall, conversion of 96 to 97% v/v of the hydrogen sulfide to elemental sulfur is achievable in a Claus process. If this is insufficient to meet air quality regulations, a Claus process tail gas treater is utilized to remove essentially the entire remaining hydrogen sulfide in the tail gas from the Claus unit. The tail gas treater may employ a proprietary solution to absorb the hydrogen sulfide followed by conversion to elemental sulfur.

The SCOT (Shell Claus Off-gas Treating) unit is also used to treat *tail gas* and uses a hydrotreating reactor followed by amine scrubbing to recover and recycle sulfur, in the form of hydrogen, to the Claus unit. In the process, tail

gas (containing hydrogen sulfide and sulfur dioxide) is contacted with hydrogen and reduced in a hydrotreating reactor to form hydrogen sulfide and water. The catalyst is typically cobalt/molybdenum on alumina. The gas is then cooled in a water contractor. The hydrogen sulfide-containing gas enters an amine absorber which is typically in a system segregated from the other refinery amine systems. The purpose of segregation is two-fold: (1) the tail gas treater frequently uses a different amine than the rest of the plant, and (2) the tail gas is frequently cleaner than the refinery fuel gas (in regard to contaminants) and segregation of the systems reduces maintenance requirements for the SCOT® unit. Amines chosen for use in the tail gas system tend to be more selective for hydrogen sulfide and are not affected by the high levels of carbon dioxide in the off-gas.

The hydrotreating reactor converts sulfur dioxide in the off-gas to hydrogen sulfide that is then contacted with a Stretford solution (a mixture of a vanadium salt, anthraquinone disulfonic acid, sodium carbonate, and sodium hydroxide) in a liquid-gas absorber. The hydrogen sulfide reacts stepwise with sodium carbonate and the anthraquinone sulfonic acid to produce elemental sulfur, with vanadium serving as a catalyst.

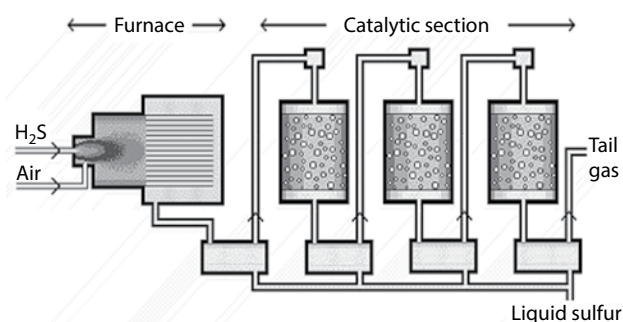
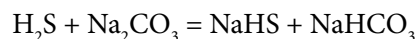

**Figure** The Claus process.

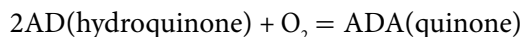
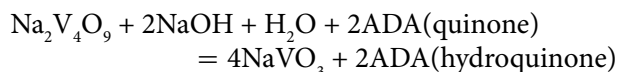
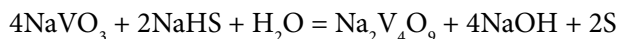

The solution proceeds to a tank where oxygen is added to regenerate the reactants. One or more froth or slurry tanks are used to skim the product sulfur from the solution, which is recirculated to the absorber.

Tail gas treating involves the removal of the remaining sulfur compounds from gases remaining after sulfur recovery. Tail gas from a typical Claus process, whether a conventional Claus or one of the extended versions of the process, usually contains small but varying quantities of carbonyl sulfide, carbon disulfide, hydrogen sulfide, and sulfur dioxide as well as sulfur vapor. In addition, there may be hydrogen, carbon monoxide, and carbon dioxide in the tail gas. In order to remove the rest of the sulfur compounds from the tail gas, all of the sulfur bearing species must first be converted to hydrogen sulfide, which is then absorbed into a solvent and the clean gas vented or recycled for further processing. Other tail gas treating processes include: (1) caustic scrubbing, (2) polyethylene glycol treatment, (3) Selectox process, (4) sulfite/bisulfite tail gas treating.

Liquid redox sulfur recovery processes are liquid-phase oxidation processes which use a dilute aqueous solution of iron or vanadium to remove hydrogen sulfide selectively by chemical absorption from sour gas streams. These processes can be used on relatively small or dilute hydrogen sulfide stream to recover sulfur from the acid gas stream or, in

some cases, they can be used in place of an acid gas removal process. The mildly alkaline lean liquid scrubs the hydrogen sulfide from the inlet gas stream, and the catalyst oxidizes the hydrogen sulfide to elemental sulfur. The reduced catalyst is regenerated by contact with air in the oxidizer(s). Sulfur is removed from the solution by flotation or settling, depending on the process.

The wet oxidation processes are based on reduction-oxidation (Redox) chemistry to oxidize the hydrogen sulfide to elemental sulfur in an alkaline solution containing an oxygen carrier. Vanadium and iron are the two oxygen carriers that are used. The best example of a process using the vanadium carrier is the Stretford process. The most prominent examples of the processes using iron as a carrier are the LO-CAT process and the SulFerox process. The Stretford process using vanadium finds little use now because of the toxic nature of the vanadium solution and iron-based processes are more common.

The LO-CAT process and the SulFerox process are essentially the same in principle. The SulFerox process differs from the LO-CAT in that the oxidation and the regeneration steps are carried out in separate vessels and sulfur is recovered from the filters, melted, and sent to sulfur storage. Also, the SulFerox process uses a higher concentration of iron chelates (about 2 to 4% by weight vs. 0.025 to 0.3% by weight for the LO-CAT process). Both processes are capable of up to 99+% w/w sulfur recovery. However, using the processes for Claus tail gas treating requires hydrolysis of all the sulfur dioxide in the tail gas to hydrogen sulfide because the sulfur dioxide will react with the buffering base potassium hydroxide (KOH) and form potassium sulfate ( $\text{K}_2\text{SO}_4$ ) which will consume the buffering solution and quickly saturate it.

# Hydrogen Sulfide

**Table** Physical properties of hydrogen sulfide.

Molecular weight	34.08
Vapour pressure at 21 °C	17.4 bar
Specific volume at 21 °C, 1 atm	701 ml/g
Boiling point at 1 atm	-60.33 °C
Freezing point at 1 atm	-85.49 °C
Specific gravity, gas at 15 °C, 1 atm (air = 1)	1.1895
Density, gas at 0 °C, 1 atm	1.5392 g/l
Density, liquid at boiling point	0.993 g/ml
Critical temperature	100.4 °C
Critical pressure	90.23 bar
Critical density	0.349 g/ml
Latent heat of vaporization at boiling point	131 cal/g
Latent heat of fusion at melting point	16.7 cal/g
Specific heat, gas at 25 °C, 1 atm	
$C_p$	0.240 cal/g °C
$C_v$	0.181 cal/g °C
ratio $C_p/C_v$	1.32
Thermal conductivity at 0 °C	$3.05 \times 10^{-5}$ cal/s cm <sup>2</sup> °C/cm
Flammable limits in air	4.3–45% by volume
Auto-ignition temperature	260 °C
Solubility in water at 20 °C, 1 atm	0.672 g/100 ml water
Viscosity, gas at 0 °C, 1 atm	0.01166 cP





# Hydrogen

**Table** Physical properties of hydrogen.

Molecular weight	2.016
Specific volume at 21 °C, 1 atm	11 967 ml/g
Boiling point at 1 atm	-252.9 °C
Triple point at 0.0695 atm	-259.3 °C
Specific gravity, gas at 23.9 °C, 1 atm (air = 1)	0.06952
Density, gas at 0 °C, 1 atm	0.0899 g/l
Density, liquid at -253 °C, 1 atm	0.0708 g/ml
Critical temperature	-240.2 °C
Critical pressure	12.98 bar
Critical density	0.03136 g/ml
Latent heat of vaporization at boiling point	106.5 cal/g
Latent heat of fusion at triple point	13.875 cal/g
Flammable limits in air	4.0–75% by volume
Auto-ignition temperature	585 °C
Specific heat, gas at 0–200 °C, 1 atm	
$C_p$	3.44 cal/g °C
$C_v$	2.46 cal/g °C
ratio $C_p/C_v$	1.40
Thermal conductivity at 0 °C	0.00040 cal/s cm <sup>2</sup> °C/cm
Viscosity, gas at 15 °C, 1 atm	0.0087 cP
Solubility in water at 15.6 °C, 1 atm	0.019 vol/vol H <sub>2</sub> O



# Hydrostatic Pressure

The hydrostatic pressure,  $p$ , in psi with density,  $\rho$ , in lb/ft<sup>3</sup> is given by:

$$p = \rho H / 144$$

$H$  is the depth in feet.



# Ideal Gas

An ideal gas is a gas in which all collisions between atoms or molecules are perfectly elastic and in which there are no intermolecular attractive forces. An ideal gas can be characterized by three variables: (1) absolute pressure,  $P$ , (2) volume,  $V$ , and (3) absolute temperature,  $T$  (*ideal gas law*). Thus: lled the:

$$PV = nRT = NkT$$

$n$  = number of moles,  $R$  = universal gas constant (= 8.3145 J/mol K),  $N$  = number of molecules  $k$  = Boltzmann constant (=  $1.38066 \times 10^{-23}$  J/K =  $8.617385 \times 10^{-5}$  eV/K),  $k = R/N_A$ ,  $N_A$  = Avogadro's number =  $6.0221 \times 10^{23}$  /mol.

The ideal gas law can arise from the pressure of gas molecules colliding with the walls of a container. And one mole of an ideal gas at standard temperature and pressure occupies 22.4 liters. However, natural gas is a non-ideal gas

and does not obey the ideal gas law but obeys the modified gas law:

$$PV = nZRT$$

$P$  is the pressure,  $V$  is the volume,  $T$  is the absolute temperature (degrees Kelvin),  $Z$  is the compressibility factor,  $n$  is the number of kilo-moles of the gas, and  $R$  is the gas constant.

For example, if all other factors remained constant, when the volume of a certain mass of gas is reduced by 50%, the pressure would double, and so on. As a gas, it would expand to fill any volume it is in. However, the compressibility,  $Z$ , is the factor which differentiates natural gas from an ideal gas. For methane,  $Z$  is 1 at 1 bar but decreases to 0.85 at 100 atmospheres, both at 25 °C, that is, it compresses to a smaller volume than the proportional relationship.



# Improved Oil Recovery Processes

Production at most oil reservoirs includes three distinct phases: primary, secondary, and enhanced recovery. During primary recovery, which uses natural pressure or artificial lift techniques to drive oil into the wellbore, only about 10% v/v of the oil-in-place is generally produced. Shortly after World War II, producers began to conduct secondary recovery techniques to extend the productive life of oil fields, increasing ultimate recovery to more than 20% v/v. Gas injection, for example, can maintain reservoir pressure and keep fluids moving; waterfloods are used to displace oil and drive it to the wellbore. In recent decades, the development and continued innovation of enhanced oil recovery (EOR) techniques has increased ultimate recovery to 30 to 60% v/v of a reservoir's original oil-in-place.

In the United States, three major categories of enhanced oil recovery technology – thermal, gas, and chemical – dominate enhanced oil recovery production. Even though improved enhanced oil recovery technology can significantly extend reservoir life and has been successfully used since the 1960s, historically high costs have limited widespread application. In the last two decades, however, dramatic improvements in analytic and assessment methods have led to a greater understanding of reservoir geology and the physical and chemical processes governing flows in porous media.

*Thermal recovery techniques* such as *steam injection and flooding* provide effective recovery of heavy, viscous crudes, which must be *thinned* to enable oil to flow freely to the wellbore. The most common domestic enhanced oil recovery practice, this process has contributed directly to improved burning efficiencies of both gas and oil, and spawned the cogeneration industry, which uses clean-burning natural gas to create both steam and electricity for oil field operators and utilities.

A second type of thermal recovery, *in situ combustion*, injects air or oxygen into the formation and uses a controlled

underground fire to burn a portion of the in-place crude. Heat and gases move oil toward production wells. This process is highly complex, involving multiphase flow of flue gases, volatile hydrocarbons, steam, hot water, and oil, and its performance in general has been insufficient to make it economically attractive to producers.

*Gas injection* – immiscible and miscible recovery – is the second most prevalent technology currently in domestic use. Two basic forms exist: (1) immiscible, in which gas does not mix with oil; and (2) miscible, in which injection pressures cause gas to dissolve in oil. *Immiscible injection*, which can use natural gas, flue gas, or nitrogen, creates an expanding force in the reservoir, pushing additional oil to the wellbore. *Miscible gas injection* dissolves propane, methane or other gases in the oil to lower its viscosity and increase its flow rate. In place of the costly hydrocarbon gases used in some enhanced oil recovery projects, miscible gas drives also frequently use carbon dioxide (CO<sub>2</sub>) and nitrogen. CO<sub>2</sub> flooding has proven to be one of the most efficient enhanced oil recovery methods, as it takes advantage of a plentiful, naturally occurring gas and can be implemented at lower pressures.

*Chemical recovery techniques* account for less than 1% of daily US enhanced oil recovery production. In an enhanced waterflooding method known as *polymer flooding*, high molecular weight, water-soluble polymers are added to the injection water to increase its viscosity relative to that of the oil it is displacing, raising yields since oil is no longer bypassed.

In another chemical recovery technique, *surfactant flooding* (also known as micellar-polymer flooding), a small slug of surfactant solution is injected into the reservoir, followed by polymer-thickened water and then brine. Despite its very high displacement efficiency, this technology is hampered by the high cost of chemicals and their environmental impact.





# Incompatible Chemicals

A wide variety of chemicals occur within and around production facilities, refineries, and petrochemical plants. Some of these chemicals react dangerously when mixed with certain other materials. An indication of some of the

more widely used incompatible chemicals are given below, but the absence of a chemical from this list should not be taken to indicate that it is safe to mix it with any other chemical.

**Table** Incompatible chemicals.

Chemical	Incompatible chemicals
acetic acid	chromic acid, ethylene glycol, nitric acid, hydroxyl compounds, perchloric acid, peroxides, permanganates
acetone	concentrated sulphuric and nitric acid mixtures
acetylene	chlorine, bromine, copper, fluorine, silver, mercury
alkali and alkaline earth metals	water, chlorinated hydrocarbons, carbon dioxide, halogens, alcohols, aldehydes, ketones, acids
aluminium (powdered)	chlorinated hydrocarbons, halogens, carbon dioxide, organic acids
anhydrous ammonia	mercury, chlorine, calcium hypochlorite, iodine, bromine, hydrofluoric acid
ammonium nitrate	acids, metal powders, flammable liquids, chlorates, nitrites, sulphur, finely divided organic combustible materials
aniline	nitric acid, hydrogen peroxide
arsenic compounds	reducing agents
azides	acids
bromine	ammonia, acetylene, butadiene, hydrocarbons, hydrogen, sodium, finely-divided metals, turpentine, other hydrocarbons
calcium carbide	water, ethanol
calcium oxide	water
carbon, activated	calcium hypochlorite, oxidizing agents
chlorates	ammonium salts, acids, metal powders, sulphur, finely divided organic or combustible materials
chromic acid	acetic acid, naphthalene, camphor, glycerin, turpentine, alcohols, flammable liquids in general
chlorine	see bromine
chlorine dioxide	ammonia, methane, phosphine, hydrogen sulfide
copper	acetylene, hydrogen peroxide
cumene hydroperoxide	adds, organic or inorganic
cyanides	acids

(Continued)

Table Cont.

flammable liquids	ammonium nitrate, chromic acid, hydrogen peroxide, nitric acid, sodium peroxide, halogens
hydrocarbons	fluorine, chlorine, bromine, chromic acid, sodium peroxide
hydrocyanic acid	nitric acid, alkali
hydrofluoric acid	aqueous or anhydrous ammonia
hydrogen peroxide	copper, chromium, iron, most metals or their salts, alcohols, acetone, organic materials, aniline, nitronmethane, flammable liquids, oxidizing gases
hydrogen sulphide	fuming nitric acid, oxidizing gases
hypochlorites	acids, activated carbon
iodine	acetylene, ammonia (aqueous or anhydrous), hydrogen
mercury	acetylene, fulminic acid, ammonia
mercuric oxide	sulphur
nitrates	sulphuric acid
nitric acid (conc.)	acetic acid, aniline, chromic acid, hydrocyanic acid, hydrogen sulphide, flammable liquids, flammable gases
oxalic acid	silver, mercury
perchloric acid	acetic anhydride, bismuth and its alloys, ethanol, paper, wood
peroxides (organic)	acids, avoid friction or shock.
phosphorus (white) potassium	air, alkalies, reducing agents, oxygen carbon tetrachloride, carbon dioxide, water, alcohols, acids
potassium chlorate	acids
potassium perchlorate	acids
potassium permanganate	glycerin, ethylene glycol, benzaldehyde, sulphuric acid
selenides	reducing agents
silver	acetylene, oxalic acid, tartaric acid, ammonium compounds, fulminic acid
sodium	carbon tetrachloride, carbon dioxide, water
sodium nitrate	ammonium salts
sodium nitrite	ammonium salts
sodium peroxide	ethanol, methanol, glacial acetic acid, acetic anhydride, benzaldehyde, carbon disulfide, glycerin, ethylene glycol, ethyl acetate, methyl acetate, furfural
sulphides	acids
sulphuric acid	potassium chlorate, potassium perchlorate, potassium permanganate for compounds with similar light metals, such as sodium, lithium, etc.)
tellurides	reducing agents
zinc powder	sulphur

# Ionic Liquids

An ionic liquid is a salt in the liquid state or a salt with a melting point lower than 100 °C (212 °F). A typical liquid is predominantly electrically neutral while ionic liquids are composed predominantly of ions and short-lived ion pairs. These substances are variously called liquid electrolytes, ionic melts, ionic fluids, fused salts, liquid salts, or ionic glasses. Ionic liquids are powerful solvents and electrically conducting fluids (electrolytes). Any salt that melts without decomposing or vaporizing usually yields an ionic liquid. Conversely, when an ionic liquid is cooled, it often forms an ionic solid which may be either crystalline or glass-like. Examples include compounds based on the 1-ethyl-3-methylimidazolium (EMIM) cation and include: 1-ethyl-3-methylimidazolium (EMIM) cation and include:  $(C_2H_5)(CH_3)C_3H_3N^+$   $N(CN)^-$  that melts at -21 °C (-6 °F) and 1-butyl-3,5-dimethylpyridinium bromide which becomes a glass below -24 °C (-11 °F).

Low-temperature ionic liquids can be compared to ionic solutions, liquids that contain both ions and neutral molecules, and in particular to the so-called deep eutectic solvents, which are mixtures of ionic and non-ionic solid substances which have much lower melting points than the pure compounds. Certain mixtures of nitrate salts can have melting points below 100 °C (212 °F).

Change to “By their very low vapor pressure, temperature stability, non-flammability and non-corrosivity, ionic liquids are ideal candidates to replace conventional organic solvents.

**Table** General properties of ionic liquids.

<i>Property</i>	<i>Comment</i>
A salt	Cation is usually large
A salt	Anion is usually small
Melting point	Preferably below 100 °C
Freezing point	Preferably below 100 °C
Liquid range	>200 °C
Thermal stability	High
Viscosity	<100 cP
Dielectric constant	<30
Polarity	Moderate
Solvent properties	Good
Catalytic properties	Good
Vapor pressure	Low-to-negligible



# Isothermal Compressibility of Oil

The isothermal compressibility of oil is the change in volume of a system as the pressure changes while temperature remains constant. For undersaturated oil, the isothermal compressibility is defined by the following equation:

$$c_o = -\frac{1}{V} \left( \frac{\partial V}{\partial p} \right)_T = -\frac{1}{B_o} \left( \frac{\partial B_o}{\partial p} \right)_T,$$

This equation reflects the change in volume with change in pressure under constant temperature conditions.

Below the bubble point pressure, isothermal compressibility of oil is defined from oil and gas properties to account for gas coming out of solution. Thus, for saturated oil compressibility is given by:

$$c_o = -\frac{1}{B_o} \left[ \left( \frac{\partial B_o}{\partial p} \right)_T - B_g \left( \frac{\partial R_s}{\partial p} \right)_T \right].$$

Above the bubble point pressure, oil volume changes as a function of isothermal compressibility only.

The oil formation volume factor (FVF) for undersaturated crude oil is determined as a function of bubblepoint oil formation volume factor, isothermal compressibility, and pressure above bubblepoint from:

$$B_o = B_{ob} e^{[c_o(p_b - p)]}.$$

## Symbols

- $c_o$  = oil isothermal compressibility,  $\text{Lt}^2/\text{m}$ ,  $\text{psi}^{-1}$
- $B_o$  = oil FVF,  $\text{bbl}/\text{STB}$
- $B_g$  = gas FVF,  $\text{ft}^3/\text{scf}$
- $T$  = temperature,  $T$ ,  $^{\circ}\text{F}$
- $R_s$  = solution GOR,  $\text{scf}/\text{STB}$
- $p$  = pressure,  $\text{m}/\text{Lt}^2$ ,  $\text{psia}$
- $B_{ob}$  = oil formation volume at bubblepoint pressure,  $\text{bbl}/\text{STB}$
- $p_b$  = bubblepoint pressure,  $\text{m}/\text{Lt}^2$ ,  $\text{psia}$



# Kinematic Viscosity

The kinematic viscosity of a liquid is the ratio of viscosity to density, both measured at the same temperature, and can be obtained by dividing the absolute viscosity of a fluid with the mass density of the fluid:

$$v = \mu/\rho$$

$v$  is the kinematic viscosity,  $\mu$  is the absolute or dynamic viscosity, and  $\rho$  is the density.

In the SI-system the theoretical unit is  $\text{m}^2/\text{s}$  or commonly used Stoke (St)

$$1 \text{ St} = 10^{-4} \text{ m}^2/\text{s}$$

The Stoke is an unpractical large unit; it is usually divided by 100 to give the unit called Centistokes (cSt):

$$1 \text{ St} = 100 \text{ cSt}$$

$$1 \text{ cSt} = 10^{-6} \text{ m}^2/\text{s}$$

Since the specific gravity of water at 20.2 °C (68.4 °F) is almost one (1), the kinematic viscosity of water at 68.4 °F is 1.0 cSt.

The viscosity of a fluid is highly temperature dependent and for either dynamic or kinematic viscosity to be meaningful, the **reference temperature** must be quoted. The usual reference temperature for a residual fluid is 100 °C and for a distillate fluid the usual reference temperature is 40 °C. For a liquid, the kinematic viscosity will decrease with an increase in temperature but for a gas the kinematic viscosity will **increase** with an increases in temperature.

Saybolt Universal Seconds (SUS) is used to measure viscosity. The efflux time is Saybolt Universal Seconds (SUS) required for 60 milliliters of a petroleum product to flow through the calibrated orifice of a Saybolt Universal viscometer, under carefully controlled temperature (ASTM D88). This method has largely been replaced by the kinematic viscosity method.

Kinematic viscosity versus dynamic or absolute viscosity can be expressed as:

$$v = 4.63\mu/SG$$

$v$  is the kinematic viscosity (SSU),  $\mu$  is the dynamic or absolute viscosity (cP), and SG is the specific gravity.





# Liquefied Petroleum Gas

*Liquefied petroleum gas (LPG)* is the term applied to certain specific hydrocarbons and their mixtures, which exist in the gaseous state under atmospheric ambient conditions but can be converted to the liquid state under conditions of moderate pressure at ambient temperature (Table). These are the light hydrocarbons fraction of the paraffin series, derived from refinery processes, crude oil stabilization plants and natural gas processing plants comprising propane ( $\text{CH}_3\text{CH}_2\text{CH}_3$ ), butane ( $\text{CH}_3\text{CH}_2\text{CH}_2\text{CH}_3$ ), *iso*-butane [ $\text{CH}_3\text{CH}(\text{CH}_3)\text{CH}_3$ ] and to a lesser extent propylene ( $\text{CH}_3\text{CH}=\text{CH}_2$ ), or butylene ( $\text{CH}_3\text{CH}_2\text{CH}=\text{CH}_2$ ). The most common commercial products are propane, butane, or some mixture of the two and are generally extracted from natural gas or crude petroleum. Propylene and butylenes result from cracking other hydrocarbons in a petroleum refinery and are two important chemical feedstocks. There are specifications for liquefied petroleum gas (ASTM D1835) that depend upon the required volatility. The different methods for gas analysis (that may also be applied to natural gas itself and other gases) include absorption, distillation, combustion, mass spectroscopy, infrared spectroscopy, and gas chromatography (ASTM D2163, ASTM D2650, ASTM D4424).

The specific gravity of product gases, including liquefied petroleum gas, may be determined conveniently by a number of methods and a variety of instruments (ASTM D1070, ASTM D4891). The heat value of gases is generally

determined at constant pressure in a flow calorimeter in which the heat released by the combustion of a definite quantity of gas is absorbed by a measured quantity of water or air. A continuous recording calorimeter is available for measuring heat values of natural gases (ASTM D1826).

The lower and upper limits of *flammability* indicate the percentage of combustible gas in air below which and above which flame will not propagate. When flame is initiated in mixtures having compositions within these limits, it will propagate and therefore the mixtures are flammable. Knowledge of flammable limits and their use in establishing safe practices in handling gaseous fuels is important, e.g., when purging equipment used in gas service, in controlling factory or mine atmospheres, or in handling liquefied gases.

Many factors enter into the experimental determination of flammable limits of gas mixtures, including the diameter and length of the tube or vessel used for the test, the temperature and pressure of the gases, and the direction of flame propagation – upward or downward. For these and other reasons, great care must be used in the application of the data. In monitoring closed spaces where small amounts of gases enter the atmosphere, often the maximum concentration of the combustible gas is limited to one-fifth of the concentration of the gas at the lower limit of flammability of the gas-air mixture.

**Table** Properties of liquefied petroleum gas.

	<b>Propane</b>	<b>Butane</b>	<b>isoButane</b>
Molecular weight	44.1	58.1	58.1
Vapour pressure at 21 °C, i.e. cylinder pressure (kg/cm <sup>2</sup> gauge)	7.7	1.15	21.6
Specific volume at 21 °C/l atm (ml/g)	530.6	399.5	405.3
Bp at 1 atm (°C)	-42.07	-0.5	-11.73
Mp at 1 atm(°C)	-187.69	-138.3	-159.6
SG, gas at 16 °C/l atm (air = 1)	1.5503	2.076	2.01
Density, liquid at sat. pressure (g/ml)	0.5505	0.5788	0.563
	(20 °C)	(20 °C)	(15 °C)
Density, gas at 0 °C/l atm (kg/m <sup>3</sup> )	2.02	2.70	-
Critical temperature (°C)	96.8	152	135
Critical pressure (atm)	42	37.5	37.2
Critical density (g/ml)	0.220	0.225	0.221
Latent heat of vap. at bp (cal/g)	101.76	92.0	37.56
Latent heat of fusion at mp (cal/g)	19.10	19.17	18.67
Specific heat, liquid at 16 °C (cal/g°C)	-	0.5636	0.5695
Specific heat, gas at 16 °C:			
C <sub>p</sub> (cal/g°C)	0.3885	0.3908	0.3872
C <sub>v</sub> (cal/g°C)	0.3434	0.3566	0.3530
ratio C <sub>p</sub> /C <sub>v</sub>	1.13	1.1	1.1
Specific heat ratio at 16 °C/l atm, C <sub>p</sub> /C <sub>v</sub>	1.131	1.096	1.097
Gross heat of combustion at 16 °C/l atm (cal/ml)	22.8	30.0	29.3
Viscosity, gas at 1 atm (centipoise)	0.00803	0.0084	0.00755
	(16 °C)	(15 °C)	(23 °C)
Coefficient of cubical expansion at 15 °C (per °C)	0.0016	0.0011	-
Surface tension (dynes/cm)	16.49	16.02	15.28
	(-50 °C)	(-10 °C)	(-20 °C)
Solubility in water at 1 atm (volumes/100 volumes water)	6.5	-	1.7
	(18 °C)	-	(17 °C)
Flammable limits in air (% by volume)	2.2-9.5	1.9-8.5	1.8-8.4
Autoignition temp. (°C)	467.8	405	543
Max. explosion pressure (MPa)	0.86	0.86	-
Min. ignition energy (MJ)	0.25	0.25	-
Max. flame temperature (°C)	2155	2130	-
Max. burning velocity (m/s)	0.45	0.38	-
Necessary min. inert gas conc. for explosion prevention in case of emergent outflow of gas in closed volumes (% v/v):			
Nitrogen	45	41	-
Carbon dioxide	32	29	-

# Liquid-Gas Separators

Several technologies are available to remove liquids and solids from gases. Each of the following gas/liquid separation technologies has guidelines for proper selection (Table): (1) gravity separator, (2) centrifugal separator, (3) mist eliminator, (4) filter vane separator, and (5) liquid/gas coalescer. The overall performance of a mist eliminator is then a balance between efficiency and pressure drop. Thus:

$$v = K [(\rho_l - \rho_v)/\rho_v]^{1/2}$$

In this equation,  $v$  is the maximum superficial gas velocity,  $\rho_l$  is the density of the liquid,  $\rho_v$  is the density of the gas,

and  $K$  is a constant which is specific to the equipment and is a function of process parameters such as (1) liquid loading, (2) gas and liquid velocity, gas pressure, and surface tension of the liquid.

**Table** Types of liquid-gas separators.

Technology	Droplet size removed
Gravity separator	Down to 300 $\mu\text{m}$
Centrifugal separator	Down to 8 TO 10 $\mu\text{m}$
Mist eliminator pad	Down to 10 $\mu\text{m}$
Vane separator	Down to 10 $\mu\text{m}$
High efficiency L/G Coalescer	Down to 0.1 $\mu\text{m}$



# Lubricants – Classification

A lubricant is a substance introduced to reduce friction between surfaces in mutual contact, which ultimately reduces the heat generated when the surfaces move. It may also have the function of transmitting forces, transporting foreign particles, or heating or cooling the surfaces. Lubricating oil is classified according to use and there are also sub-classifications such as in the category known as automotive lubricants (Table).

**Table** Classification of automotive lubricants.

SAE Nos	ASTM D 445
Winter grades	Viscosity mm <sup>2</sup> /s
0 W	3.8 (min) at 100 °C and 3250 (max) at -35 °C
5 W	3.8 (min) at 100 °C and 3500 (max) at -30 °C
10 W	4.1 (min) at 100 °C and 3500 (max) at -25 °C
15 W	5.6 (min) at 100 °C and 3500 (max) at -20 °C
20 W	5.6 (min) at 100 °C and 4500 (max) at -10 °C
25 W	9.3 (min) at 100 °C and 6000 (max) at -5 °C
Summer grades	Viscosity in mm <sup>2</sup> /s at 100 °C
20	5.6 (min) and 9.3 (max)
30	9.3 (min) and 12.5 (max)
40	12.5 (min) and 16.3 (max)
50	16.3 (min) and 21.9 (max)
60	21.9 (min) and 26.1 (max)



# Lubricating Oil – Base Stock

Lubricating oils are composed of base stock (base oil) that is initially produced from refining crude oil (*mineral base oil*) or through chemical synthesis (*synthetic base oil*). Base oil is typically defined as oil with a boiling point range between 300 °C (550 °F) and 565 °C (1050 °F), consisting of

hydrocarbons with 18 to 40 carbon atoms with a high flash point and is sub-divided into various categories (Table 1, Table 2). This oil can be either paraffinic or naphthenic in nature depending on the chemical structure of the constituent molecules.

**Table 1** Properties of lubricating oil base stocks.

Name of the lube base stock	Spindle oil	Intermediate oil	Heavy oil	Bright stock
Property	specification	specification	specification	specification
Flash point, (closed cup), minimum	150 °C	243–260 °C	266–288 °C	288–300 °C
Viscosity index, min	95	95	90	90
Viscosity, kinematic, @ 98.9 °C, max	2.6-2.75 cst	8–9.9	13–17	35–45
CCR % wt, max	0.01	0.05	0.3	0.6–2.5
Pour point, max	–12 °C	–12 °C	–6 °C	–6 °C
Saponification value, max	1	1	1	1
Neutralization number, max	1	1	1	1

**Table 2** Base oil categories as published by the American petroleum institute.

	Base oil category	Sulfur (%)		Saturates (%)	Viscosity Index
Mineral	Group I (solvent refined)	>0.03	and/or	<90	80 to 120
	Group II (hydrotreated)	<0.03	and	>90	80 to 120
	Group III (hydrocracked)	<0.03	and	>90	>120
Synthetic	Group IV	PAO Synthetic Lubricants			
	Group V	All other base oils not included in Groups I, II, III or IV			





## M85

M85 is an alcohol fuel mixture containing 85% v/v methanol and 15% v/v gasoline. Methanol is typically made from natural gas, but can also be derived from the fermentation of biomass (such as wood hence wood alcohol). Because it is easier to transport natural gas to a distant market by converting it to methanol, which is a liquid at ordinary temperatures and pressures, than by chilling and liquefying it or by building a long pipeline, some petroleum-exporting countries are looking at exporting their *waste* natural gas (which they currently dispose of by *flaring*) by converting it to methanol.

Methanol is more corrosive than gasoline (though it is less toxic and not carcinogenic); this is why an automaker needs to change some of the materials in the fuel-handling systems of both the vehicle and the refueling station to materials that can withstand attack by the fuel. Special oil additives are necessary in order to protect the engine. Also, because the mixture of air to fuel is much richer than gasoline (about 8 to 1 by weight, compared to about 14 to 1 for gasoline), there is more liquid fuel available to wash oil off cylinder walls during a cold start.



# Marx-Langenheim Model

The Marx-Langenheim model is a series of mathematical equations for calculating heat transfer in a hot water or steam flood. Many of the currently available simplified methods are based on the reservoir heating model of Marx and Langenheim, which considers the injection of hot fluid into a well at constant rate and temperature (Figure). The operation element consists of a radial flow system, concentric about the point of injection. They assumed the temperature of the heated zone to be uniform at the down-hole temperature of the injected fluid ( $T_s$ ) and the reservoir temperature outside the heated zone to be at the initial and reference temperature ( $T_R$ ).

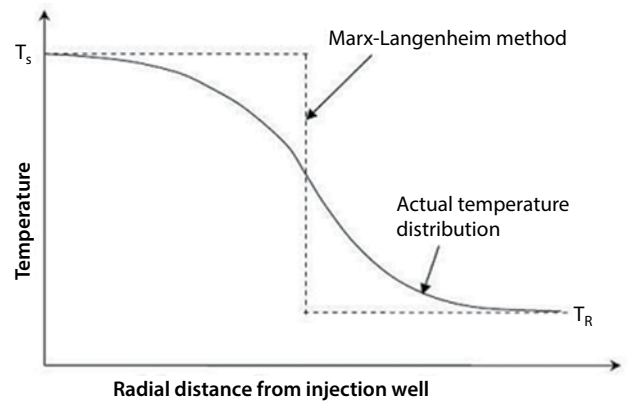

**Figure** Schematic of the Marx-Langenheim temperature profile.



# Material Balance

*Material balance (mass balance)* is an application of conservation of mass, an expression for conservation of mass, governed by the observation that the amount of mass leaving a control volume is equal to the amount of mass entering the volume minus the amount of mass accumulated in the volume.

$$M_{\text{Original}} = M_{\text{Remaining}} + M_{\text{Removed}}$$

Furthermore, the pressures measured over time can be used to estimate the volume of hydrocarbons in place.

The *material balance method* for a crude oil and natural gas field uses an equation that relates the volume of oil, water and gas that has been produced from a reservoir, and the change in reservoir pressure, to calculate the remaining oil. It assumes that as fluids from the reservoir are produced, there will be a change in the reservoir pressure that depends on the remaining volume of oil and gas. The method requires extensive pressure-volume-temperature analysis and an accurate pressure history of the field. It requires some production to occur (typically 5% to 10% v/v of ultimate recovery), unless reliable pressure history can be used from a field with similar rock and fluid characteristics.

By accounting for material entering and leaving a system, mass flows can be identified which might have been unknown, or difficult to measure without this technique. The exact conservation law used in the analysis of the system depends on the context of the problem but all revolve around mass conservation insofar as matter cannot be created spontaneously or be destroyed.

Some of the assumptions that can be made about material balance equations are: (1) masses and volumes of components are additive, (2) material is neither generated nor lost from the system, (3) for a three-component mixture of oil (o), water (w) and solids (s), where:

$$MW = D_s V_s + D_o V_o + D_w V_w$$

$$V_s + V_o + V_w = 100\%$$

V is the volume percent, D is the specific gravity, and MW is the mixture weight). (4) there is uniform distribution of pressures and saturations, (5) all areas are can be swept or reached by fluids, (6) the reservoir properties are homogeneous properties, and (7) the reservoir is a tank.

Material balance is important in reservoir engineering since it can provide an estimate of initial HC in place and is independent of geological interpretation and can be used to verify volumetric estimates. Material balance can be used to help evaluate operating strategies such as new wells.

The general material balance equation is simply a volumetric balance, which states that since the volume of a reservoir (as defined by its initial limits) is a constant, the algebraic sum of the volume changes of the oil, free gas, water, and rock volumes in the reservoir must be zero. For example, if both the oil and gas reservoir volumes decrease, the sum of these two decreases must be balanced by changes of equal magnitude in the water and rock volumes. If the assumption is made that complete equilibrium is attained at all times in the reservoir between the oil and its solution gas, it is possible to write a generalized material balance expression relating the quantities of oil, gas, and water produced, the average reservoir pressure, the quantity of water that may have encroached from the aquifer, and finally the initial oil and gas content of the reservoir. In making these calculations the following production, reservoir, and laboratory data are involved:

1. The initial reservoir pressure and the average reservoir pressure at successive intervals after the start of production.
2. The stock tank barrels of oil produced, measured at 1 atmosphere and 60 °F, at any time or during any production interval.
3. The total standard cubic feet of gas produced. When gas is injected into the reservoir, this will be the

difference between the total gas produced and that returned to the reservoir.

4. The ratio of the *initial* gas cap volume to the initial oil volume, symbol  $m$ .

$m = (\text{initial reservoir free gas volume}) / (\text{initial reservoir oil volume})$

If this value can be determined with reasonable precision, there is only one unknown ( $N$ ) in the material balance on volumetric gas cap reservoirs, and two ( $N$  and  $W$ ) in water-drive reservoirs. The value of  $m$  is determined from log and core data and from data from the completion of the well, which frequently helps to locate the gas-oil and water-oil contacts. The ratio  $m$  is known in many instances much more accurately than the absolute values of the gas cap and oil zone volumes. For example, when the rock in the gas cap and that in the oil zone appear to be essentially the same, it may be taken as the ratio

of the net or even the gross volumes, without knowing the average connate water or average porosity, or when gross volumes are used, the factors for reducing gross to net productive volumes.

5. The gas and oil volume factors and the solution gas-oil ratios. These are obtained as functions of pressure by laboratory measurements on bottom-hole samples by the differential and flash liberation methods.
6. The quantity of water that has been produced.
7. The quantity of water that has been encroached into the reservoir from the aquifer.

For simplicity, the derivation is divided into the changes in the oil, gas, water, and rock volumes that occur between the start of production and any time,  $t$ . The change in the rock volume is expressed as a change in the void lace volume, which is simply the negative of the change in the rock volume.

## Mean Density – Gas-Air Mixture

Once a gas or vapor has been mixed with air, it is the mean density of the mixture which is important (similar considerations arise when mixing other gases). The mean density of a gas mixture is given by:

$$p_{mixture} = (p_g V_g + p_a V_a) / (V_g + V_a)$$

$V_g, V_a$  are the volumes of gas and air,  $p_g$  and  $p_a$  the densities of gas and air, respectively. If  $V_a$  is large relative to  $V_g$ , or if  $p_g$  does not differ significantly from  $p_a$ , the value of  $p_{mixture}$  approximates to  $p_a$ .





## Mean Density – Gas-Air Mixture

Once a gas or vapor has been mixed with air, it is the mean density of the mixture which is important (similar considerations arise when mixing other gases). The mean density of a gas mixture is given by:

$$\rho_{mixture} = (\rho_g V_g + \rho_a V_a) / (V_g + V_a)$$

$V_g$ ,  $V_a$  are the volumes of gas and air,  $\rho_g$ , and  $\rho_a$  the densities of gas and air respectively. If  $V_a$  is large relative to  $V_g$ , or if  $\rho_g$  does not differ significantly from  $\rho_a$ , the value of  $\rho_{mixture}$  approximates to  $\rho_a$ .



## Metals Content and FCC Coke Production

A number of indices relate metal activity to hydrogen and coke production. (These indices predate the use of metal passivation in the FCC process but are still reliable.) The most commonly used index is  $4 \times$  nickel + vanadium. This indicates that nickel is four times as active as vanadium in producing hydrogen. Other indices used are:

$$\text{Jersey nickel equivalent index} = 1000 (\text{Ni} + 0.2 \times \text{V} + 0.1 \times \text{Fe})$$

$$\text{Shell contamination index} = 1000 (14 \times \text{Ni} + 14 \times \text{Cu} + 4 \times \text{V} + \text{Fe})$$

$$\text{Davison index} = \text{Ni} + \text{Cu} + \text{V}/4$$

$$\text{Mobil index} = \text{Ni} + \text{V}/4$$

In every equation, nickel is the most active. These indices convert all metals to a common basis, generally either vanadium or nickel. Metals are most active when they first deposit on the catalyst. With time, they lose the initial effectiveness through continuous oxidation-reduction cycles. Typically, approximately one-third of the nickel on the equilibrium catalyst will have the activity to promote dehydrogenation reactions.



# Methane

**Table** Physical properties of methane.

Molecular weight	16.04
Specific volume @ 21 °C	1479.5 ml/g
Boiling point @ 1 atm	-161,5 °C
Freezing point @ 1 atm	-182.6 °C
Triple point	-182.5 °C
Triple point pressure	0.115 atm
Specific gravity (gas) @ 16 °C, 1 atm	0.5549
Density (gas) @ 0 °C, 1 atm	0.72 g/l
Density (liquid) @ bp	0.4256 g/l
Critical temperature	-82.1 °C

Critical pressure	673.3 psia (45.8 atm)
Critical density	0.162 g/ml
Latent heat of vaporization @ bp	121.54 cal/g
Specific heat (gas) @ 16 °C, 1 atm $C_p/C_v$	1.307
Flammable limits in air	5.3–14%
Autoignition temperature	540 °C
Minimum ignition energy	0.28 mJ
Flame temperature	1880 °C
Limiting oxygen index	11.5%
Viscosity (gas) @ 1 atm, 4.4 °C	0.0106 cP



# Molecular Weight of Petroleum Fractions

Prediction of the molecular weight of petroleum fractions is estimated by use of the following equation:

$$M = 42.965[\exp(2.097 \times 10^{-4} T_b - 7.78712 SG + 2.08476 \times 10^{-3} T_b SG)] T_b^{1.26007} SG^{4.98308}$$

M is the molecular weight of the petroleum fraction,  $T_b$  is the mean average boiling point of the petroleum fraction in K, and SG is the specific gravity, 60 °F/60 °F.





# Naphthenic Acids – Corrosion in Distillation Units

Naphthenic acids are a naturally occurring, complex mixture of cycloaliphatic carboxylic acids recovered from petroleum and from petroleum distillates, and the term *naphthenic acid* – as used in the petroleum industry – refers collectively to all of the carboxylic acids present in crude oil. Naphthenic acids are classified as monobasic carboxylic acids of the general formula  $\text{RCOOH}$ , in which R represents the naphthene moiety consisting of cyclopentane and cyclohexane derivatives as well as any acyclic aliphatic acids. Although alicyclic (naphthenic) acids appear to be the more prevalent on the naphthenic acid class, phenol derivatives are also present in crude oil and which are often included in the naphthenic acid category.

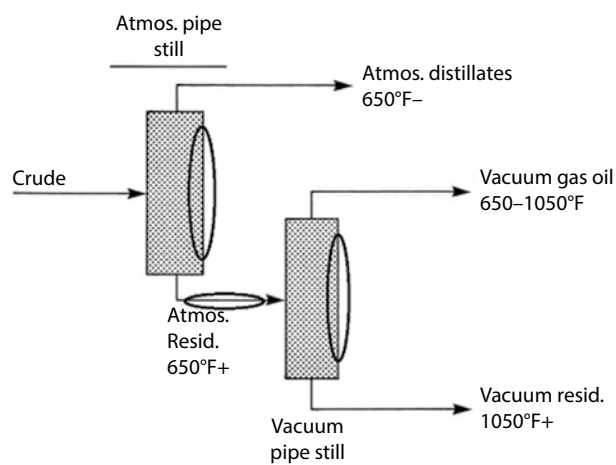



# Naphthenic Acids – Mitigating Corrosion

Removing naphthenic acid constituents from crude oils and/or preventing acidic corrosion is regarded as one of the most important processes in heavy oil upgrading. Current industrial practices either depend on dilution or caustic washing methods to reduce the total acid number (TAN) of heavy crude oils. However, neither of these approaches is entirely satisfactory. For instance, by blending a high acid crude oil with a low acid crude oil it is possible to reduce the naphthenic acid content of the blended feedstock to an acceptable level.

There is a variety of methods that are in use to attempt to mitigate naphthenic acid corrosion during crude oil refining. The final word is that such methods may be crude oil dependent and there may be no one method that can be used for all crude oils to reduce the effects of the naphthenic acid constituents.

**Table** Method for mitigating corrosion by naphthenic acids.

Blending
<ul style="list-style-type: none"> <li>• Typically, blend high TAN with low TAN crude</li> <li>• Blending primarily based on desired product mix</li> <li>• Metallurgy can become limiting</li> <li>• Crude compatibility needs evaluation</li> <li>• Sulfur in blend crude may be critical</li> </ul>
Materials Upgrade
<ul style="list-style-type: none"> <li>• In mild service, 9 Cr-1 Mo steel is often adequate</li> <li>• Usually 316L (2% Mo) minimum material</li> <li>• 317L (3% Mo) often used</li> <li>• Structured packing requires 317L min.</li> </ul>
Use of Inhibitors
<ul style="list-style-type: none"> <li>• Continuous use of high acid crudes             <ul style="list-style-type: none"> <li>• Successful applications exist for wide range of TAN and NAT</li> <li>• Important to maintain monitoring in areas at risk</li> <li>• Can be continuous or until metallurgy is upgraded.</li> </ul> </li> <li>• Intermittent use of high acid crudes             <ul style="list-style-type: none"> <li>• Used when corrosion rates are excessive based on monitoring</li> </ul> </li> <li>• Cost directly related to amount of equipment protected</li> </ul>



# Naphthenic Acids

The term *naphthenic acid* (or *naphthenic acids*) is a collective name for organic acids present in some but not all crude oils. In addition to true naphthenic acids (naphthenic carboxylic acids represented by the formula X-COOH in which X is typically a cycloparaffin moiety), the total acidity of a crude may include various amounts of other organic acid derivatives (such as phenol derivatives, ArOH where Ar is an aromatic moiety) and sometimes mineral acids. Thus the *total* neutralization number of a feedstock, which is a measure of its total acidity, includes (but does not necessarily represent) the level of naphthenic acids present.

The neutralization number is the number of milligrams of potassium hydroxide required to neutralize one gram of stock as determined by titration using phenolphthalein as an indicator, or as determined by potentiometric titration.

It may be as high as 10 mg KOH/gr for some crude oils. The neutralization number does not usually become important as a corrosion factor, however, unless it is at least 0.5 mg KOH/gm.

In terms of classification, which is not scientifically based, high-acid crudes often fall into the sub-group of crude oils known as opportunity crudes. Generally, *opportunity crude oils* are often dirty and need cleaning before refining by removal of undesirable constituents such as high-sulfur, high-nitrogen, and high-aromatics (such as polynuclear aromatic) components. A controlled visbreaking treatment would *clean up* such crude oils by removing these undesirable constituents (which, if not removed, would cause problems further down the refinery sequence) as coke or sediment.



## Natural Gas - Associated

Almost all oil reservoirs except those classified as extra heavy reservoirs or tar sand deposits will produce natural gas at the surface. Crude oil is not transported in a commercial pipeline or a tanker with gas still in the solution. The term stock tank oil, which is used both as

a measure for oil well performance and in commercial pricing of oil, means that all associated gas has been stripped from the liquid at one atmosphere pressure. The gas thus liberated from the crude oil is known as *associated gas*.





# Natural Gas – Composition

Natural gas is a combustible mixture of hydrocarbon gases (Mokhatab et al., 2006). While natural gas is formed primarily of methane, it can also include ethane, propane, butane, and pentane. The composition of natural gas can vary widely before it is refined (Table 1). In its purest form, such as the natural gas that is delivered to the consumer is almost pure methane.

The primary component of natural gas is methane ( $\text{CH}_4$ ), the shortest and lightest hydrocarbon molecule. It also contains heavier gaseous hydrocarbons such as ethane ( $\text{C}_{2\text{H}_6}$ ), propane ( $\text{C}_{3\text{H}_8}$ ) and butane ( $\text{C}_{4\text{H}_{10}}$ ), as well as other sulfur containing gases, in varying amounts; see also natural gas condensate. Natural gas also contains and is the primary market source of helium. Natural gas contains hydrocarbons and non-hydrocarbon gases. Hydrocarbon gases are methane ( $\text{CH}_4$ ), ethane ( $\text{C}_2\text{H}_6$ ), propane ( $\text{C}_3\text{H}_8$ ), butanes ( $\text{C}_4\text{H}_{10}$ ), pentanes ( $\text{C}_5\text{H}_{12}$ ), hexane ( $\text{C}_6\text{H}_{14}$ ), heptane ( $\text{C}_7\text{H}_{16}$ ), and sometimes trace amounts of octane ( $\text{C}_8\text{H}_{18}$ ), and higher molecular weight hydrocarbons. Some aromatics [BTX – benzene ( $\text{C}_6\text{H}_6$ ), toluene ( $\text{C}_6\text{H}_5\text{CH}_3$ ), and the xylenes ( $\text{CH}_3\text{C}_6\text{H}_4\text{CH}_3$ )] can also be present, raising safety issues due to their toxicity. The non-hydrocarbon gas portion of the natural gas contains nitrogen ( $\text{N}_2$ ), carbon dioxide ( $\text{CO}_2$ ), helium (He), hydrogen sulfide ( $\text{H}_2\text{S}$ ), water vapor ( $\text{H}_2\text{O}$ ), and other sulfur compounds (such as carbonyl sulfide (COS) and mercaptans (e.g.,  $\text{CH}_3\text{SH}$ ) and trace amounts of other gases. Carbon dioxide and hydrogen sulfide are commonly referred to as *acid gases* since they form corrosive compounds in the presence of water. Nitrogen, helium, and carbon dioxide are also referred to as *diluents* since none of these burn, and thus they have no heating value. Mercury can also be present either as a metal in vapor phase or as an organo-metallic compound in liquid fractions. Concentration levels are generally very small, but even at very small concentration levels, mercury can be detrimental due its toxicity and its corrosive properties (reaction with aluminum alloys).

Within the natural gas family, the composition of *associated gas* (a by-product of oil production and the oil recovery process) is extremely variable, even within the gas from a particular petroleum reservoir. After the production fluids are brought to the surface, they are separated at a tank battery at or near the production lease into a hydrocarbon liquid stream (crude oil or condensate), a produced water stream (brine or salty water), and a gas stream.

The gas stream traditionally has high proportions of *natural gas liquids* (NGLs) and is referred to as *rich gas*. Natural gas liquids are constituents such as ethane, propane, butane, and pentanes and higher molecular weight hydrocarbon constituents. The higher molecular weight constituents (i.e., the C5+ product) are commonly referred to as *natural gasoline*. Rich gas will have a high heating value and a high hydrocarbon dew point. When referring to natural gas liquids in the gas stream, the term *gallon per thousand cubic feet* is used as a measure of high molecular weight hydrocarbon content. On the other hand, the composition of non-associated gas (sometimes called *well gas*) is deficient in natural gas liquids. The gas is produced from geological

**Table 1** Variation of composition of natural gas.

	% v/v
Methane	70 to 90
Ethane	4 to 12
Propane	0 to 4
Butane	0.1 to 1.0
Pentane	0.1 to 0.2
Carbon dioxide	0 to 8
Oxygen	0 to 0.2
Nitrogen	0 to 5
Hydrogen sulfide	0 to 5
Rare gases	trace

formations that typically do not contain much, if any, hydrocarbon liquids. As expected, the properties of associated gas and non-associated gas differ considerably when both gases are in the unrefined state but once refined to produce methane, the properties of the methane are evident.

Generally, the hydrocarbons having a higher molecular weight than methane, carbon dioxide, and hydrogen sulfide are removed from natural gas prior to its use as a fuel. However, since the composition of natural gas is never constant, there are standard test methods by which the composition and properties of natural gas can be determined (Table 2) and, thus, prepared for use.

Organic sulfur compounds and hydrogen sulfide are common contaminants that must be removed prior to most uses. Gas with a significant amount of sulfur impurities, such as hydrogen sulfide, is termed *sour gas* and often referred to as acid gas. Processed natural gas that is available to end-users is tasteless and odorless. However, before gas is distributed to end users, it is odorized by adding small amounts of thiols, to assist in leak detection. Processed natural gas is, in itself, harmless to the human body. However, natural gas is a simple asphyxiant and can kill if it displaces air to the point where the oxygen content will not support life.

**Table 2** Standard test methods for natural gas.

ASTM D1070. Standard Test Methods for Relative Density of Gaseous Fuels
ASTM D1071. Standard Test Methods for Volumetric Measurement of Gaseous Fuel Samples
ASTM D1072. Standard Test Method for Total Sulfur in Fuel Gases
ASTM D1142. Standard Test Method for Water Vapor Content of Gaseous Fuels by Measurement of Dew-Point Temperature
ASTM D1826. Standard Test Method for Calorific (Heating) Value of Gases in Natural Gas Range by Continuous Recording Calorimeter
ASTM D1945. Standard Test Method for Analysis of Natural Gas by Gas Chromatography
ASTM D1946. Standard Practice for Analysis of Reformed Gas by Gas Chromatography
ASTM D1988. Standard Test Method for Mercaptans in Natural Gas Using Length-of-Stain Detector Tubes
ASTM D3588. Standard Practice for Calculating Heat Value, Compressibility Factor, and Relative Density of Gaseous Fuels
ASTM D3956. Standard Specification for Methane Thermophysical Property Tables
ASTM D3984. Standard Specification for Ethane Thermophysical Property Tables
ASTM D4084. Standard Test Method for Analysis of Hydrogen Sulfide in Gaseous Fuels (Lead Acetate Reaction Rate Method)
ASTM D4150. Standard Terminology Relating to Gaseous Fuels
ASTM D4362. Standard Specification for Propane Thermophysical Property Tables
ASTM D4468. Standard Test Method for Total Sulfur in Gaseous Fuels by Hydrogenolysis and Rateometric Colorimetry
ASTM D4650. Standard Specification for Normal Butane Thermophysical Property Tables
ASTM D4651. Standard Specification for Isobutane Thermophysical Property Tables
ASTM D4784. Standard for LNG Density Calculation Models
D4810-88. Standard Test Method for Hydrogen Sulfide in Natural Gas Using Length-of-Stain Detector Tubes
ASTM D4888. Standard Test Method for Water Vapor in Natural Gas Using Length-of-Stain Detector Tubes
ASTM D4891-89(2001) Standard Test Method for Heating Value of Gases in Natural Gas Range by Stoichiometric Combustion.
ASTM D4984. Standard Test Method for Carbon Dioxide in Natural Gas Using Length-of-Stain Detector Tubes
ASTM D5287. Standard Practice for Automatic Sampling of Gaseous Fuels
ASTM D5454. Standard Test Method for Water Vapor Content of Gaseous Fuels Using Electronic Moisture Analyzers
ASTM D5503. Standard Practice for Natural Gas Sample-Handling and Conditioning Systems for Pipeline Instrumentation
ASTM D5504. Standard Test Method for Determination of Sulfur Compounds in Natural Gas and Gaseous Fuels by Gas Chromatography and Chemiluminescence
ASTM D5954. Standard Test Method for Mercury Sampling and Measurement in Natural Gas by Atomic Absorption Spectroscopy
ASTM D6228. Standard Test Method for Determination of Sulfur Compounds in Natural Gas and Gaseous Fuels by Gas Chromatography and Flame Photometric Detection
ASTM D6273. Standard Test Methods for Natural Gas Odor Intensity
ASTM D6350. Standard Test Method for Mercury Sampling and Analysis in Natural Gas by Atomic Fluorescence Spectroscopy

Properties of hydrocarbons that typically occur in natural gas.

Gas	Molecular weight	Boiling point 1 atm, °C (°F)	Density at 60 °F (15.6 °C), 1 atm real gas	
			g/liter	Relative to air = 1
Methane	16.043	-161.5 (-258.7)	0.6786	0.5547
Ethylene	28.054	-103.7 (-154.7)	1.1949	0.9768
Ethane	30.068	-88.6 (-127.5)	1.2795	1.046
Propylene	42.081	-47.7 (-53.9)	1.8052	1.4757
Propane	44.097	-42.1 (-43.8)	1.8917	1.5464
1,2- Butadiene	54.088	10.9 (51.6)	2.3451	1.9172
1,3-Butadiene	54.088	-4.4 (24.1)	2.3491	1.9203
1-Butene	56.108	-6.3 (20.7)	2.4442	1.9981
cis-2-Butene	56.108	3.7 (38.7)	2.4543	2.0063
trans-2-Butene	56.108	0.9 (33.6)	2.4543	2.0063
iso-Butene	56.104	-6.9 (19.6)	2.4442	1.9981
n-Butane	58.124	-5.4 (31.1)	2.532	2.0698
iso-Butane	58.124	-11.7 (10.9)	2.5268	2.0656



# Natural Gas – Compressibility

The isothermal gas compressibility, which is given the symbol  $c_g$ , is a useful concept which will be used extensively in determining the compressible properties of the reservoir. The isothermal compressibility is also called the bulk modulus of elasticity. Gas usually is the most compressible medium in the reservoir. However, care should be taken so that it not be confused with the gas deviation factor,  $z$ , which is sometimes called the super-compressibility factor.

The isothermal gas compressibility is defined as:

$$c_g = -\frac{1}{V_g} \left( \frac{\partial V_g}{\partial p} \right)_T$$

An expression in terms of  $z$  and  $p$  for the compressibility can be derived from the real gas law:

$$\left( \frac{\partial V_g}{\partial p} \right)_T = \frac{nRT}{p} \left( \frac{\partial z}{\partial p} \right)_T - \frac{znRT}{p^2} = \left( \frac{znRT}{p} \right) \frac{1}{z} \frac{dz}{dp} - \left( \frac{znRT}{p} \right) \times \frac{1}{p}$$

From the real gas equation of state:

$$\frac{1}{V_g} = \frac{p}{znRT}$$

Hence

$$\frac{1}{V_g} \left( \frac{\partial V_g}{\partial p} \right)_T = \frac{1}{z} \frac{dz}{dp} - \frac{1}{p}$$

Hence

$$c_g = \frac{1}{p} - \frac{1}{z} \left( \frac{\partial z}{\partial p} \right)_T$$

For gases at low pressures the second term is small and the compressibility can be approximated by  $c_g \approx 1/p$ . Equation 2 is not particularly convenient for determining the gas compressibility because  $z$  is not actually a function of  $p$  but of  $p_r$ . However, equation 2 can be made convenient in terms of a dimensionless pseudo-reduced gas compressibility defined as:

$$c_r = c_g p_{pc}$$

Multiplying equation 2 through by the pseudo-critical pressure,  $c_r = c_g p_{pc} = \frac{1}{p_r} - \frac{1}{z} \left( \frac{\partial z}{\partial p_r} \right)_T$

The expression for calculating the pseudo-reduced compressibility is:

$$c_r = \frac{1}{p_r} - \frac{0.27}{z^2 T_r} \left( \frac{(\partial z / \partial p_r)_{T_r}}{1 + \left( \frac{\rho_r}{z} \right) \left( \frac{\partial z}{\partial \rho_r} \right)_{T_r}} \right)$$

There is also a close relationship between the formation volume factor of gas and the isothermal gas compressibility. It can be easily shown that:

$$c_g = -\frac{1}{B_g} \left( \frac{\partial B_g}{\partial p} \right)_T$$



# Natural Gas – Measurement

Before natural gas is sold to the consumer, it must be evaluated (tested for favorable properties) and measured so that the consumer received the correct amount of gas. Natural gas can be measured in a number of different ways (Table) but it is more often measured by volume at normal temperatures and pressures and the volume is commonly expressed in *cubic feet* at a temperature of 60 °F and an atmospheric pressure of 14.7 pounds per square inch.

Natural gas is measured (either at the time of production or at the time of delivery to the consumer) in thousands or millions of cubic feet (Mcf or Mscf and MMcf or MMscf, where *scf* is standard cubic feet under prescribed conditions); resources and reserves are calculated in trillions of cubic feet (Tcf). Natural gas is sold in cubic feet (a container 10 feet deep, 10 feet long, and 10 feet wide would hold 1,000 cubic feet of natural gas) or in British Thermal Units (Btu), which is a measure of the heat content or burning properties of natural gas.

When natural gas is delivered to a residence, it is measured by the gas utility in *therms* for billing purposes; a *therm* is equivalent to 100,000 Btu's, or just over 97 cubic feet, of natural gas. On the other hand, production and distribution companies commonly measure natural gas in thousands of cubic feet (Mcf), millions of cubic feet (MMcf), or trillions of cubic feet (Tcf).

The measurement of natural gas may not always be an understandable concept because natural gas can be measured in several different ways. To place the measurement in context: 1,000 cubic feet of natural gas is approximately enough to meet the natural gas needs of an average home (space-heating, water-heating, cooking, etc.) for four days, and 5 trillion cubic feet of natural gas is enough to meet the needs of 5 million households (in the United States) for approximately 15 years. By comparison, 1,000 cubic feet of natural gas (approximately 1 million Btu or 10 therms) is equivalent to 90 pounds of coal or to 125 pounds of oven-dried wood or to 8 gallons of (automobile) gasoline.

**Table** Measurement units often applied to natural gas.

1 cubic foot (ft <sup>3</sup> cf or scf standard cubic foot)	=	1,027 Btu
100 cubic feet (scf)	=	1 therm (approximate)
1,000 cubic feet (Mcf)	=	1,027,000 Btu (1 MMBtu)
1,000 cubic feet (Mcf)	=	1 dekatherm (10 therms)
1 million (1,000,000) cubic feet (MMcf)	=	1,027,000,000 Btu
1 billion (1,000,000,000) cubic feet (Bcf)	=	1.027 trillion Btu
1 trillion (1,000,000,000,000) cubic feet (Tcf)	=	1.027 quadrillion Btu





## Natural Gas – Nonassociated

Gas that occurs in reservoirs without the presence of crude oil is referred to as *nonassociated natural gas*. Typically, these reservoirs occur at greater depth. If the fluid gas brought to the surface remains gaseous, then it is referred to as *dry gas*. If the surface pressures cause some

liquid hydrocarbons to evolve, it is referred to as *wet gas*. However, while nonassociated gas reservoirs are likely to be found at greater depths, upward migration from the source rock over geologic time can result in shallow gas reservoirs.



# Natural Gas – Properties

The properties of unrefined natural gas are variable because the composition of natural gas is never constant. Therefore, the properties and behavior of natural gas are best understood by investigating the properties and behavior of the constituents. Thus, assuming that the natural gas has been cleaned (i.e., any constituents such as carbon dioxide and hydrogen sulfide have been removed and the only constituents remaining are hydrocarbons), the properties and behavior of natural gas becomes a study of the properties and behavior of the relevant hydrocarbons. When natural gas is refined and any remaining hydrocarbons are removed, the sole component of the gas that is sold to the consumer (other than an odorizer, such as a mercaptan) is methane (CH<sub>4</sub>) and the properties are constant (Table 1).

The composition of natural gas varies depending on the field, the formation, or the reservoir from which it is extracted and that are an artifact of its formation. The different hydrocarbons that form natural gas can be separated using their different physical properties as weight, boiling point, or vapor pressure. Depending on its content of higher molecular weight hydrocarbon components, natural gas can be considered as rich (five or six gallons or more of recoverable hydrocarbon components per cubic feet) or lean (less than one gallon of recoverable hydrocarbon components per cubic feet).

*Density* is the mass of a substance contained in a unit volume (simply, density is mass divided by volume). In the SI system of units, the ratio of the density of a substance to the density of water at 15 °C is known as the *specific gravity* (*relative density*). Various units of density, such as kg/m<sup>3</sup>, lb-mass/ft<sup>3</sup>, and g/cm<sup>3</sup>, are commonly used. In addition, molar densities or the density divided by the molecular weight is often specified.

*Density* values (including those of natural gas hydrocarbons; Figure 1) are given at room temperature unless otherwise indicated by the superscript figure; for example, 2.487<sup>15</sup> indicates a density of 2.487 g/cm for the substance at 15 °C.

A superscript 20 over a subscript 4 indicates a density at 20 °C relative to that of water at 4 °C. For gases the value of the density is given in grams per liter (g/L). Another term, specific gravity, is commonly used in relation to the properties of hydrocarbons. The specific gravity of a substance is a comparison of its density to that of water.

The density of any gas compared to the density of air is the *vapor density* and is a very important characteristic of the constituents of natural gas and natural gas constituents (Table 2, Table 3; Figure 2). Put simply, if the constituents of natural gas are less dense (lighter) than air, they

**Table 1** General properties of unrefined natural gas (left hand data) and refined natural gas (right hand data).

Relative molar mass	20–16
Carbon content [weight %]	73–75
Hydrogen content [weight %]	27–25
Oxygen content [weight %]	0.4–0
Hydrogen-to-hydrogen atomic ratio	3.5–4.0
Density relative to air @15 °C	1.5–0.6
Boiling temperature [°C/1 atmosphere]	–162
Autoignition temperature [°C]	540–560
Octane number	120–130
Methane number	69–99
Vapor flammability limits [volume %]	5–15
Flammability limits	0.7–2.1
Lower heating/calorific value [Btu]	900
Methane concentration [volume %]	100–80
Ethane concentration [volume %]	5–0
Nitrogen concentration [volume %]	15–0
Carbon dioxide concentration [volume %]	5–0
Sulphur concentration [ppm, mass]	5–0

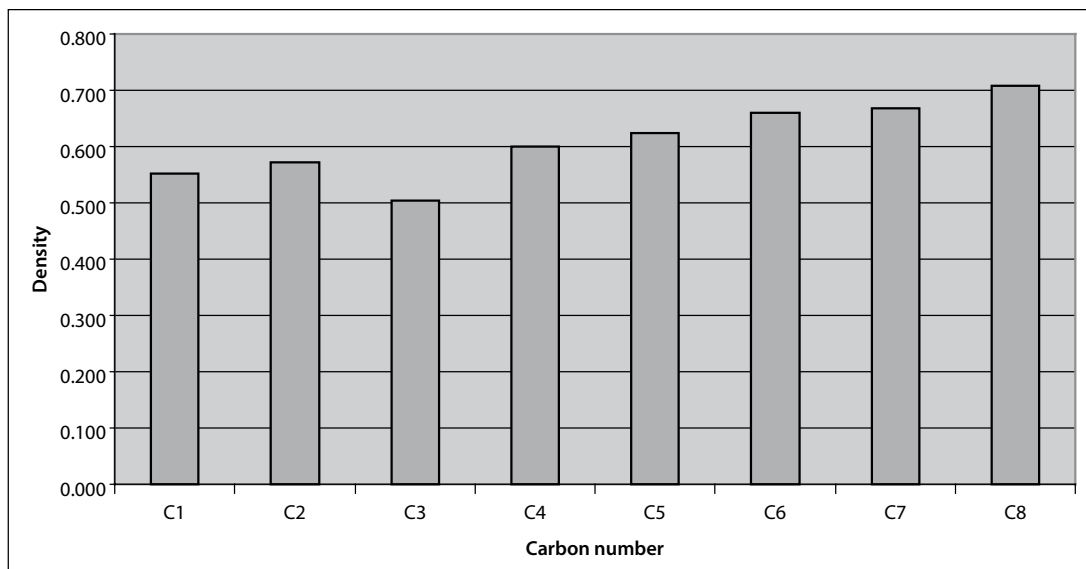

**Figure 1** Carbon number and density of natural gas hydrocarbons (up to n-Octane,  $C_8H_{18}$ ).

**Table 2** General properties of the constituents of natural gas up to and including n-octane ( $C_8H_{18}$ ) as well as toluene, ethyl benzene, and xylene.

	Molecular weight	Specific gravity	Vapor density air = 1	Boiling point °C	Ignition temperature °C	Flash point °C
Methane	16	0.553	0.56	-160	537	-221
Ethane	30	0.572	1.04	-89	515	-135
Propane	44	0.504	1.50	-42	468	-104
Butane	58	0.601	2.11	-1	405	-60
Pentane	72	0.626	2.48	36	260	-40
Hexane	86	0.659	3.00	69	225	-23
Benzene	78	0.879	2.80	80	560	-11
Heptane	100	0.668	3.50	98	215	-4
Octane	114	0.707	3.90	126	220	13
Toluene	92	0.867	3.20	161	533	4
Ethyl benzene	106	0.867	3.70	136	432	15
Xylene	106	0.861	3.70	138	464	17

**Table 3** Molecular weights and critical properties of pure components of natural gas.

Compound	Chemical composition	Molecular weight	Critical pressure, psi	Critical temperature (°R)
Methane	$CH_4$	16.04	673	344
Ethane	$C_2H_6$	30.07	709	550
Propane	$C_3H_8$	44.09	618	666
iso-Butane	$C_4H_{10}$	58.12	530	733
n- Butane	$C_4H_{10}$	58.12	551	766
iso-Pentane	$C_5H_{12}$	72.15	482	830
n-Pentane	$C_5H_{12}$	72.15	485	847
n-Hexane	$C_6H_{14}$	86.17	434	915
n-Heptane	$C_7H_{16}$	100.2	397	973
n-Octane	$C_8H_{18}$	114.2	361	1024
Nitrogen	$N_2$	28.02	492	227
Carbon dioxide	$CO_2$	44.01	1,072	548
Hydrogen sulfide	$H_2S$	34.08	1,306	673

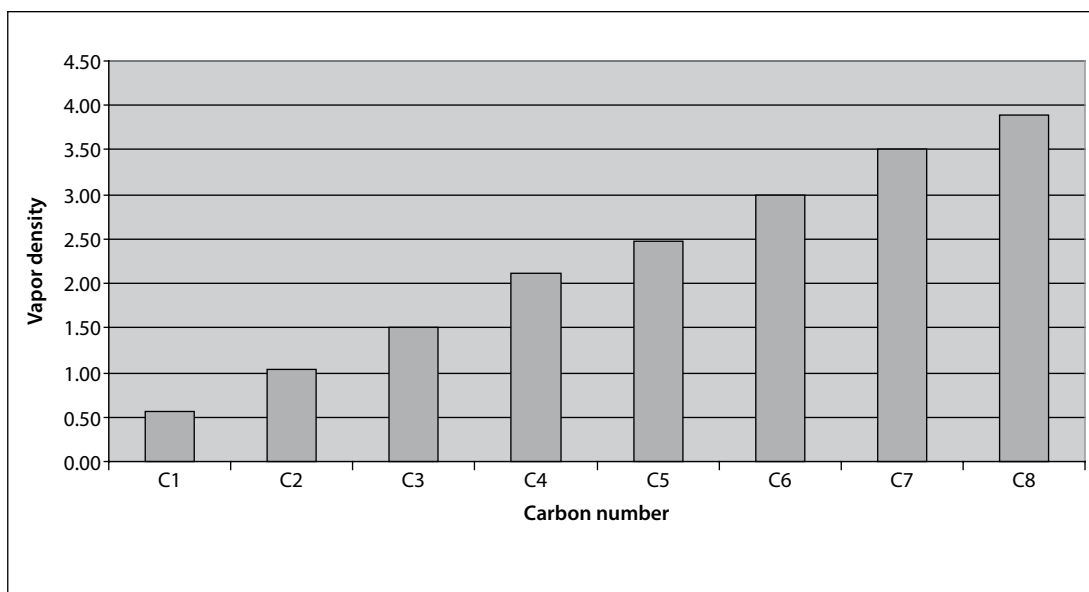

**Figure 2** Carbon number and vapor density (relative to air = 1.0) of natural gas hydrocarbons (up to octane,  $C_8H_{18}$ ).

will dissipate into the atmosphere, whereas if the constituents of natural gas are denser (heavier) than air, they will sink and be less likely to dissipate into the atmosphere. Of the hydrocarbon constituents of natural gas, methane is the only one that is less dense than air. The statement is often made that *natural gas is lighter than air*. This statement often arises because of the continued insistence by engineers and scientists that the properties of a mixture are determined by the mathematical average of the properties of the individual constituents of the mixture. Such mathematical bravado and inconsistency of thought is *detrimental to safety* and needs to be qualified.

Relative to air, methane is less dense (Table 4) but the other hydrocarbon constituents of unrefined natural gas (i.e., ethane, propane, butane, etc.) are denser than air (Figure 2). Therefore, should a natural gas leak occur in field operations, especially where the natural gas contains constituents other than methane, only methane dissipates readily into the air, whereas the other hydrocarbon constituents that are heavier than air do not readily dissipate into the atmosphere. This poses considerable risk if these constituents of natural gas accumulate or pool at ground level when it has been erroneously assumed that natural gas is lighter than air.

The *heat of combustion (energy content)* of natural gas is the amount of energy that is obtained from the burning of a volume of natural gas; it is measured in British thermal units (Btu). The value of natural gas is calculated by its Btu content. One Btu is the quantity of heat required to raise the temperature of one pound of water of 1 degree Fahrenheit at atmospheric pressure. A cubic foot of natural gas has an energy content of approximately 1031 Btu, but the range of values is between 500 and 1,500 Btu depending upon the composition of the gas.

**Table 4** Boiling point and density of methane relative to air and water.

- Boiling Point (760 mm Hg):  $-161.5\text{ }^{\circ}\text{C}$  ( $-258.7\text{ }^{\circ}\text{F}$ )
- Gas Specific Gravity: 0.55 to 0.64 (air = 1.00)
- Specific Gravity of Liquefied Natural Gas: 0.42 to 0.46 (water = 1.00)
- Gas Density (varies slightly): 0.0438 lbm/scf

In the United States, at retail, natural gas is often sold in units of therms (th) (1 therm = 100,000 BTU. Wholesale transactions are generally done in decatherms (Dth), or in thousand decatherms (MDth), or in million decatherms (MMDth). A million decatherms is roughly a billion cubic feet of natural gas.

The gross heats of combustion of crude oil and its products are given with fair accuracy by the equation:

$$Q = 12,400 - 2100d^2$$

where  $d$  is the 60/60F specific gravity. Deviation from the formula is generally less than 1%.

Before natural gas is sold to the consumer, it must be evaluated (tested for favorable properties) and *measured* so that the consumer receives the correct amount of gas. Natural gas can be measured in a number of different ways but it is more often measured by volume at normal temperatures and pressures; the volume is commonly expressed in *cubic feet* at a temperature of 60°F and an atmospheric pressure of 14.7 pounds per square inch. Thus, natural gas is measured (either at the time of production or at the time of delivery to the consumer) in thousands or millions of cubic feet (Mcf or Mscf and MMcf or MMscf, where *scf* is standard cubic feet under prescribed conditions); resources and reserves are

calculated in trillions of cubic feet (Tcf). Natural gas is sold in cubic feet (a container 10 feet deep, 10 feet long, and 10 feet wide would hold 1,000 cubic feet of natural gas) or in British Thermal Units (Btu), which is a measure of the heat content or burning properties of natural gas.

The measurement of natural gas may not always be an understandable concept because natural gas can be measured in several different ways (Table 5). To place the measurement in context: 1,000 cubic feet of natural gas is approximately enough to meet the natural gas needs of an average home (space-heating, water-heating, cooking, etc.) for four days and 5 trillion cubic feet of natural gas is enough to meet the needs of 5 million households (in the United States) for approximately 15 years. By comparison, 1 thousand cubic feet of natural gas (approximately 1 million Btu or 10 therms) is equivalent to 90 pounds of coal or to 125 pounds of oven-dried wood or to 8 gallons of (automobile) gasoline.

The boiling point (boiling temperature) of a substance is the temperature at which the vapor pressure of the substance is equal to atmospheric pressure. At the boiling point, a substance changes its state from liquid to gas. A stricter definition of boiling point is the temperature at which the liquid and vapor (gas) phases of a substance can exist in equilibrium. When heat is applied to a liquid, the temperature of the liquid rises until the *vapor pressure* of the liquid equals the pressure of the surrounding atmosphere (gases).

At this point there is no further rise in temperature, and the additional heat energy supplied is absorbed as *latent heat* of vaporization to transform the liquid into gas. This transformation occurs not only at the surface of the liquid (as in the case of *evaporation*) but also throughout the volume of the liquid, where bubbles of gas are formed. The boiling point of a liquid is lowered if the pressure of the surrounding atmosphere (gases) is decreased. On the other hand, if the pressure of the surrounding atmosphere (gases) is increased, the boiling point is raised. For this reason, it is customary when the boiling point of a substance is given to include the pressure at which it is observed, if that pressure is other than standard, i.e., 760 mm of mercury or 1 atmosphere (STP, Standard Temperature and Pressure).

The boiling points of petroleum fractions are rarely, if ever, distinct temperatures. It is, in fact, more correct to refer to the boiling ranges of the various fractions; the same is true of natural gas. To determine these ranges, the material in question is tested in various methods of distillation, either at atmospheric pressure or at reduced pressure. Thus, the boiling points of the hydrocarbon constituents of natural gas increase with molecular weight and the initial boiling point of natural gas corresponds to the boiling point of the most volatile constituents (i.e., methane) (Figure 3).

The *flash point* of petroleum or a petroleum product, including natural gas, is the temperature to which the product must be heated under specified conditions to give off

**Table 5** Measurement units often applied to natural gas.

1 cubic foot (cf or scf standard cubic foot)	=	1,027 Btu
100 cubic feet (scf)	=	1 therm (approximate)
1,000 cubic feet (Mcf)	=	1,027,000 Btu (1 MMBtu)
1,000 cubic feet (Mcf)	=	1 dekatherm (10 therms)
1 million (1,000,000) cubic feet (MMcf)	=	1,027,000,000 Btu
1 billion (1,000,000,000) cubic feet (Bcf)	=	1.027 trillion Btu
1 trillion (1,000,000,000,000) cubic feet (Tcf)	=	1.027 quadrillion Btu

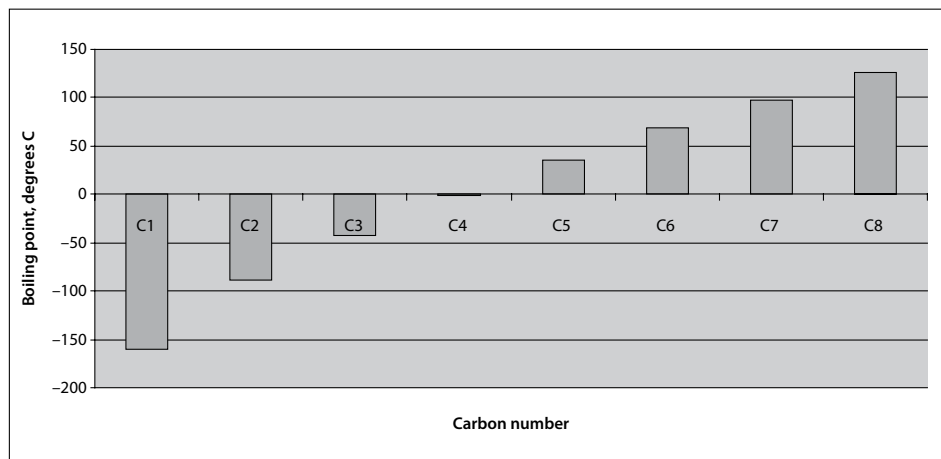

**Figure 3** Carbon Number and Boiling Points of Natural Gas Hydrocarbons (up to n-Octane,  $C_8H_{18}$ ).

sufficient vapor to form a mixture with air that can be ignited momentarily by a specified flame (ASTM D56, ASTM D92, ASTM D93). As with other properties, the flash point is dependent on the composition of the gas and the presence of other hydrocarbon constituents (Figure 4). The *fire point* is the temperature to which the gas must be heated under the prescribed conditions of the method to burn continuously when the mixture of vapor and air is ignited by a specified flame (ASTM D92).

From the viewpoint of safety, information about the flash point is of most significance at or slightly above the maximum temperatures (30 to 60 °C, 86 to 140 °F) that may be encountered in storage, transportation, and use of liquid petroleum products, in either closed or open containers. In this temperature range the relative fire and explosion hazard can be estimated from the flash point. For products with flash point below 40 °C (104 °F) special precautions are necessary for safe handling. Flash points above 60 °C (140 °F) gradually lose their safety significance until they become indirect measures of some other quality.

A further aspect of volatility that receives considerable attention is the vapor pressure of petroleum and its constituent fractions. The *vapor pressure* is the force exerted on the walls of a closed container by the vaporized portion of a liquid. Conversely, it is the force that must be exerted on the

liquid to prevent it from vaporizing further (ASTM D323). The vapor pressure increases with temperature for any given gasoline, liquefied petroleum gas, or any other petroleum product. The temperature at which the vapor pressure of a liquid, either a pure compound or a mixture of many compounds, equals 1 atmosphere (14.7 psi, absolute) is designated as the boiling point of the liquid.

The flammable range is expressed by the *lower explosive limit* (LEL) and the *upper explosive limit* (UEL). The *lower explosive limit* is the concentration of natural gas in the air below which the propagation of a flame will not occur on contact with an ignition source. The *lower explosive limit* for natural gas is 5% by volume in air and, in most cases, the smell of gas would be detected well before combustion conditions are met. The *upper explosive limit* is the concentration of natural gas in the air above which the propagation of a flame will not occur on contact with an ignition source. The natural gas *upper explosive limit* is 15% by volume in air.

In any form, a minute amount of odorant that has an obvious smell is added to the otherwise colorless and odorless gas, so that leaks can be detected before a fire or explosion occurs. Odorants are considered non-toxic in the extremely low concentrations occurring in natural gas delivered to the end user.

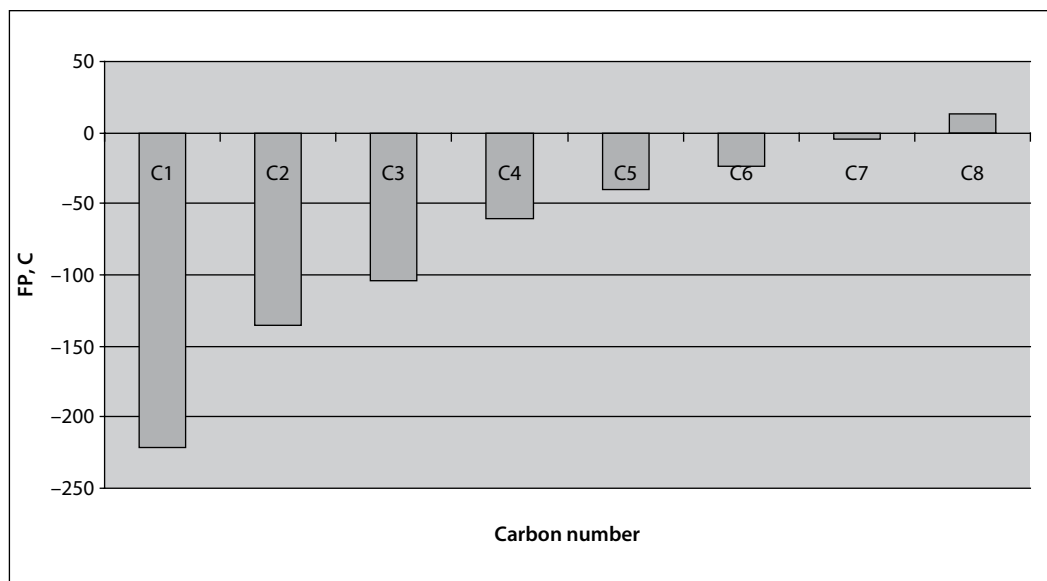

**Figure 4** Carbon number and flash point of natural gas hydrocarbons (up to n-Octane,  $C_8H_{18}$ ).





## Natural Gas – Specific Gravity

The specific gravity of natural gas,  $\gamma_g$ , as commonly used in the crude oil and natural gas industry, is defined as the ratio of the molecular weight of a particular natural gas to that of air. The molecular weight of a gas mixture is the summation of the products of the individual mole fractions and molecular weights of each individual component. Air itself is a mixture of gases. Thus, the specific gravity of natural gas can be derived from:

$$\gamma_g = \frac{MW_m}{MW_{atr}} = \frac{\sum_{t=1}^n y_t MW_t}{28.97}.$$

$MW_i$  is the molecular weight of the individual components in the gas mixture,  $y_i$  is the mole fractions of the individual components in the gas mixture,  $n$  is the total gas components in the gas mixture, and 28.97 is the calculated molecular weight of air.



# Natural Gas – Phase Behavior

Depending on where and from what type of reservoir the natural gas is produced, its composition can vary widely. Generally, it contains primarily methane ( $\text{CH}_4$ ) with decreasing quantities of ethane ( $\text{C}_2\text{H}_6$ ), propane ( $\text{C}_3\text{H}_8$ ), butane ( $\text{C}_4\text{H}_{10}$ ), and pentane ( $\text{C}_5\text{H}_{12}$ ). Some natural gas mixtures can also contain nonhydrocarbon gases such as carbon dioxide ( $\text{CO}_2$ ), nitrogen ( $\text{N}_2$ ), hydrogen sulfide ( $\text{H}_2\text{S}$ ), and traces of rare gases (Ar, He, Ne, Xe). No matter what the natural composition of gas is, the product delivered and finally used by the consumers is almost pure methane. Thus, natural gas phase behavior is not only a function of pressure, temperature, and volume, but also the various constituents (Table). Therefore, it is very often illustrated by the PVT diagram or phase behavior envelope (Figure). Understanding phase behavior is critical to the hydrocarbon recovery mechanism and production prediction. Certain concepts associated with phase envelopes are:

- Bubble Point Curve: the curve that separates the pure liquid (oil) phase from the two-phase (natural

gas and oil) region. This means that at a given temperature, when pressure decreases and below the bubble point curve, gas will be emitted from the liquid phase to the two-phase region.

- Dew Point Curve: the curve that separates the pure gas phase from the two-phase region. It is the connected points of pressure and temperature at which the first liquid droplet is formed out of the gas phase.
- Critical Point: the point on the phase envelope where the bubble point curve meets the dew point curve. At that given pressure and temperature, gas properties are identical to liquid properties. The pressure and temperature at the critical point are called critical pressure and temperature, respectively.
- Cricondetherm: the highest temperature at which liquid and vapor can coexist. That means the mixture will be gas irrespective of pressure when the temperature is larger than cricondetherm.
- Cricondenbar: the highest pressure at which a liquid and vapor can coexist.

**Table** Molecular weight and critical properties of pure components (up to n-Octane) that Can Occur in Natural Gas.

Compound	Chemical composition	Molecular weight	Critical pressure (psi)	Critical temperature, (°R)
Methane	$\text{CH}_4$	16.04	673	344
Ethane	$\text{C}_2\text{H}_6$	30.07	709	550
Propane	$\text{C}_3\text{H}_8$	44.09	618	666
iso-Butane*	$\text{C}_4\text{H}_{10}$	58.12	530	733
n- Butane	$\text{C}_4\text{H}_{10}$	58.12	551	766
iso-Pentane*	$\text{C}_5\text{H}_{12}$	72.15	482	830
n-Pentane	$\text{C}_5\text{H}_{12}$	72.15	485	847
n-Hexane	$\text{C}_6\text{H}_{14}$	86.17	434	915
n-Heptane	$\text{C}_7\text{H}_{16}$	100.2	397	973
n-Octane	$\text{C}_8\text{H}_{18}$	114.2	361	1024
Nitrogen	$\text{N}_2$	28.02	492	227
Carbon dioxide	$\text{CO}_2$	44.01	1,072	548
Hydrogen sulfide	$\text{H}_2\text{S}$	34.08	1,306	673

\*Not typically present in natural gas but included here for comparison.

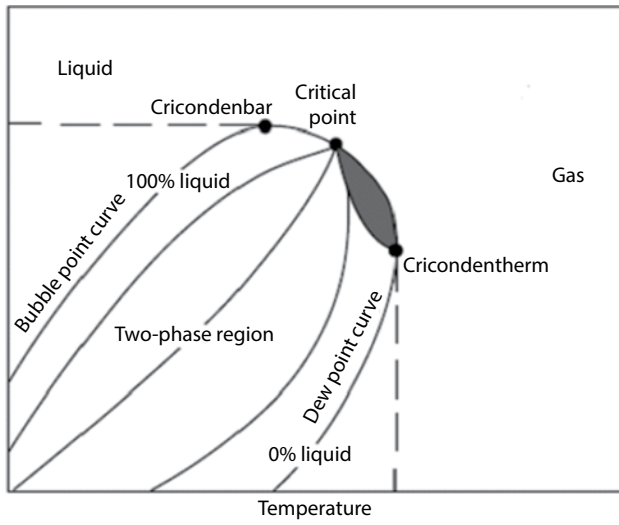

**Figure** Phase diagram for natural gas.

# Natural Gas – Sweetening

A natural gas sweetening process is any process that is designed to remove carbon dioxide and especially hydrogen sulfide for the gas stream before the gas is sent to sales. Sour gas means the amount of hydrogen sulfide in natural gas is above the acceptable industry limits, while sweet gas means

the gas virtually has no hydrogen sulfide (either it does not have it in the first place or it is treated).

The sweetening processes are variable and offer a variety of chemical and physical methods for removal of both carbon dioxide and hydrogen sulfide (Table).

**Table** Summary of the natural gas sweetening processes.

<b>Iron-Sponge Sweetening</b>
Reaction:
$2\text{Fe}_2\text{O}_3 + 6\text{H}_2\text{S} \rightarrow 2\text{Fe}_2\text{S}_3 + 6\text{H}_2\text{O}$
Regeneration:
$2\text{Fe}_2\text{S}_3 + 3\text{O}_2 \rightarrow 2\text{Fe}_2\text{O}_3 + 6\text{S}$
A batch process; most applicable for small gas volume with low content of hydrogen sulfide; operating temperature of the vessel <120 °F (<49 °C).
<b>Alkanolamine Sweetening</b>
Reaction:
$\text{MEA} + \text{H}_2\text{S} \rightarrow \text{MEA-hydrosulfide} + \text{heat}$
$\text{MEA} + \text{H}_2\text{O} + \text{CO}_2 \rightarrow \text{MEA-carbonate} + \text{heat}$
Regeneration:
$\text{MEA-hydrosulfide} + \text{heat} \rightarrow \text{MEA} + \text{H}_2\text{S}$
$\text{MEA-carbonate} + \text{heat} \rightarrow \text{MEA} + \text{H}_2\text{O} + \text{CO}_2$
Alkanolamine: organic compounds including monoethanolamine (MEA), diethanolamine (DEA), and triethanolamine (TEA); not selective and have to be designed for total acid-gases removal; operating $p > 125$ psi for DEA; can absorb most of the acid gases and meet the specified pipeline requirement.
<b>Glycol/Amine Process</b>
A solution composed of 10–30% w/w MEA, 45–85% w/w glycol, and 5–25% w/w water for the simultaneous removal of water vapor, hydrogen sulfide, and carbon dioxide; the process flow scheme is essentially the same as that for MEA; applicable when low dew point is not required; there can be losses of MEA due to vaporization in the regeneration stage at high temperature.
<b>Sulfinol Process</b>
The solvent (composed of sulfolane, diisopropanolamine (DIPA), and water) acts as the physical (sulfolane) and chemical (DIPA) solvent; there is the benefit of low solvent circulation rates, smaller equipment, and lower cost; on the other hand, there can be absorption of high molecular weight hydrocarbon derivatives and aromatic derivatives.

(Continued)

Table Cont.

Chemsweet Process and Zinc Oxide Process
Reaction:
$ZnAc_2 + H_2S \rightarrow ZnS + 2HAc$ , $ZnO + H_2S \rightarrow ZnS + H_2O$
Regeneration:
$ZnO + 2HAc \rightarrow ZnAc_2 + H_2O$
Can be used to treat gas with a high concentration of hydrogen sulfide; operating $p$ on the order of 89 to 1,415 psi; should not be used when the mercaptan concentration is in excess of 10% v/v hydrogen sulfide in the gas stream – mercaptans react with ZnO and forms Zn(OH)RH which will form a sludge and possibly cause foaming problems.

# Natural Gasoline

Natural gasoline is a liquid isolated from natural gas streams and has a vapor pressure that is intermediate between natural gas condensate (sometimes referred to as *drip gas*) and higher-boiling alkanes and which has a boiling range within the range of refinery naphtha. The typical API gravity of natural gasoline is on the order of 80.

Natural gasoline is a highly volatile liquid at ambient pressure and temperature but can be blended with other hydrocarbon derivatives to produce commercial gasoline. The hydrocarbon mixture of natural gasoline is mostly composed of pentane derivatives and lower amounts of the higher molecular weight hydrocarbons (Table) that meets vapor pressure, end-point, and other specifications for natural gasoline set by the Gas Processors Association.

**Table** Composition of natural gasoline from a natural gas well.

Reid vapor pressure	38 psia	60 psia	100 psia
Ethane	Trace	0.5	0.7
Propane	1.1	16	43.8
Isobutane	19	16	10.7
n-Butane	41	34.7	23
Isopentane	13.2	11.2	7.4
n-Pentane	11.3	9.5	6.3
Hexane	6.8	5.7	3.8
Heptane	5.3	4.4	2.9
Octane	1.2	1	0.7
Nonane	1.1	1	0.7
Decane	Trace	Trace	Trace
	100	100	100





# Nitrogen and Nitrogen Oxide Gases

**Table 1** Physical properties of nitrogen (N<sub>2</sub>).

Molecular weight	28.0134
Specific volume @ 21°C	861.5 ml/g
Boiling point @ 1 atm	-195.8°C
Triple point	-210.0°C
Triple point pressure	94.24 mm Hg
Density (gas) @ 20°C	1.250 g/l
Density (liquid) @ bp	0.8064 g/ml
Critical temperature	-147.1°C
Critical pressure	33.5 atm
Critical density	0.311 g/ml
Latent heat of vaporization @ bp	47.51 cal/g
Specific heat (gas) @ 16°C, 1 atm	
$C_p$	0.2477 cal/g°C
$C_v$	0.1765 cal/g°C
ratio $C_p/C_v$	1.4
Viscosity (gas) @ 15°C, 1 atm	0.01744 centipoises
Dielectric constant (liquid) @ bp	1.433
Solubility in water @ 0°C	2.3 ml/100 ml water

**Table 2** Physical properties of nitrous oxide (N<sub>2</sub>O).

Molecular weight	44.013
Vapour pressure @ 21 °C	745 psig
Specific volume @ 21 °C, 1 atm	543 ml/g
Boiling point @ 1 atm	-89.5 °C
Freezing point @ 1 atm	-90.84 °C
Specific gravity (gas) @ 15 °C, 1 atm	1.530
Density (gas) @ 0°C, 1 atm	1.907 g/l
Density (liquid) @ bp	1.266 g/l
Critical temperature	36.5°C
Critical pressure	1054 psia (71.7 atm)
Critical density	0.457 g/l
Latent heat of vaporization @ bp	89.9 cal/g
Specific heat gas @ 25 °C, 1 atm	
$C_p$	0.2098 cal/g °C
$C_v$	0.1610 cal/g °C
ratio $C_p/C_v$	1.3
Viscosity (gas) @ 0 °C, 1 atm	0.01362 centipoise
Solubility in water @ 0°C, 1 atm	1.3 volumes/volume of water

**Table 3** Physical properties of nitric oxide (NO).

Molecular weight	30.006
Specific volume @ 21 °C, 1 atm	811 ml/g
Boiling point @ 1 atm	-151.7 °C
Freezing point @ 1 atm	-163.6 °C
Density (gas) @ 0 °C, 1 atm	1.3402 g/l
Density (liquid) @ bp	1.269 g/l
Critical temperature	-93 °C
Critical pressure	940.8 psia (64 atm)
Critical density	0.52 g/ml
Latent heat of vaporization @ bp	110.2 cal/g
Specific heat (gas) @ 15 °C, 1 atm	
$C_p$	0.2328 cal/g °C
$C_v$	0.1664 cal/g °C
ratio $C_p/C_v$	1.4
Viscosity (gas) @ 15 °C 1 atm	0.0178 cP
Solubility in water @ 0 °C, 1 atm	7.34 ml/100 g water

**Table 4** Physical properties of nitrogen dioxide (NO<sub>2</sub>).

Molecular weight	46.005 (or 92.01 for the tetroxide)
Vapour pressure @ 21 °C	14.7 psia
Specific volume @ 21 °C, 1 atm	293.4 ml/g
Boiling point @ 1 atm	21.25 °C
Freezing point @ 1 atm	-9.3 °C
Specific gravity (gas) @ 20 °C, 1 atm	1.58
Density (gas) @ 21 °C, 1 atm	3.3 g/l
Density (liquid) @ 20 °C	1.448 g/ml
Critical temperature	158.0 °C
Critical pressure	1470 psia (100 atm)
Critical density	0.56 g/ml
Latent heat of vaporization @ bp	99.0 cal/g
Specific heat (gas) @ 25 °C, 1 atm $C_p$	0.1986 cal/g °C
Viscosity (liquid) @ 20 °C	4.275 millipoises

# Nonassociated Natural Gas

Gas that occurs in reservoirs without the presence of crude oil is referred to as *nonassociated natural gas*. Typically, these reservoirs occur at greater depth. If the fluid gas brought to the surface remains gaseous, then it is referred to as *dry gas*. If the surface pressures cause some

liquid hydrocarbons to evolve, it is referred to as *wet gas*. However, while nonassociated gas reservoirs are likely to be found at greater depths, upward migration from the source rock over geologic time can result in shallow gas reservoirs.



# Octane Barrel Yield

The octane barrel yield is a measure used to evaluate fluid catalytic cracking processes; defined as  $(RON + MON)/2$  multiplied by the gasoline (or naphtha) yield, where RON is the research octane number and MON is the motor octane number.



# Octane Number

Gasoline performance and hence quality of an automobile gasoline is determined by its resistance to knock, for example, *detonation* or *ping* during service. The antiknock quality of the fuel limits the power and economy that an engine using that fuel can produce: the higher the anti-knock quality of the fuel, the more the power and efficiency of the engine.

Octane numbers are obtained by the two test procedures, those obtained by the first method are called *motor octane numbers* (indicative of high-speed performance) (ASTM D2700). Those obtained by the second method are called *research octane numbers* (indicative of normal road performance) (ASTM D2699) (Table). Octane numbers quoted are usually, unless stated otherwise, research octane numbers.

In the test methods used to determine the antiknock properties of gasoline, comparisons, are made with blends of two pure hydrocarbons, *n*-heptane and *iso*-octane (2,2,4-trimethylpentane). *iso*-octane has an octane number of 100 and is high in its resistance to knocking; *n*-heptane is quite low (with an octane number of 0) in its resistance to knocking.

**Table** Octane numbers of selected hydrocarbons.

Hydrocarbon	RON	MON
n-heptane (by definition)	0	0
2-methylheptane	23	24
n-hexane	25	26
1-pentene	34	
2-methylhexane	44	46
3-methylhexane		55
1-heptene	60	
n-pentane	62	62
Neopentane (dimethylpropane)		80
n-butane	94	90
Isopentane (methylbutane)		90
2,2-dimethylbutane		93
2,3-dimethylbutane		94
i-butane	102	98
2,3,3-trimethylpentane	106	99
ethane	108	
2,2,3-trimethylpentane	110	100
propane	112	97
2,2,3-trimethylbutane	112	101
xylene	118	115
toluene	121	107
methane	120	120





# Oil and Gas from Tight Formations

The terms *tight oil* and *tight gas* refer to crude oil (primarily light sweet crude oil) and natural gas, respectively, that are contained in formations such as shale or tight sandstone, where the low permeability of the formation makes it difficult for producers to extract the crude oil or natural gas except by unconventional techniques such as horizontal drilling and hydraulic fracturing. The terms *unconventional oil* or *unconventional gas* are umbrella terms for crude oil and natural gas that are produced by methods that do not meet the criteria for conventional production. Unlike conventional mineral formations containing natural gas and crude oil reserves, shale and other tight formations have low permeability, which naturally limits the flow of natural gas and crude oil. In such formations, the natural gas and crude oil are held in largely unconnected pores and natural fractures. Hydraulic fracturing is the method commonly used to connect these pores and allow the gas to flow.

Tight sandstone formations and shale formations are heterogeneous and vary widely over relatively short distances. Thus, even in a single horizontal drill hole, the amount of gas or oil recovered may vary, as may recovery within a field or even between adjacent wells. This makes evaluation of tight

plays (a *play* is a group of fields sharing geological similarities where the reservoir and the trap control the distribution of oil and gas). Because of the variability of the reservoirs – even reservoirs within a play – decisions regarding the profitability of wells on a particular lease are difficult. Furthermore, the production of crude oil from tight formations requires that at least 15 to 20% v/v of the reservoir pore space is occupied by natural gas to provide the necessary reservoir energy to drive the oil toward the borehole; tight reservoirs which contain only oil cannot be economically produced (EIA, 2013).

In tight shale reservoirs and other tight reservoirs, there are areas known as *sweet spots* which are preferential targets for drilling and releasing the gas and oil. In these areas, the permeability of the formation is significantly higher than the typical permeability of the majority of the formations. The occurrence of a sweet spot and the higher permeability may often result from open natural fractures, formed in the reservoir by natural stresses, which results in the creation of a dense pattern of fractures. Such fractures may have reclosed, filled in with other materials or may still be open. However, a well that can be connected through hydraulic fracturing to open natural fracture systems can have a significant flow potential.

**Table 1** Typical properties of fluids occurring in shale formations and in tight formations.

Constituents (% v/v)	Dry gas	Wet gas	Condensate	Volatile oil*
CO <sub>2</sub>	0.1	1.4	2.4	1.8
N <sub>2</sub>	2.1	0.3	0.3	0.2
C <sub>1</sub>	86.1	92.5	73.2	57.6
C <sub>2</sub>	5.9	3.2	7.8	7.4
C <sub>3</sub>	3.6	1.0	3.6	4.2
Butane derivatives (C <sub>4</sub> )	1.7	0.5	2.2	2.8
Pentane derivatives (C <sub>5</sub> )	0.5	0.2	1.3	1.5
Hexane derivatives (C <sub>6+</sub> )		0.1	1.1	1.9
Heptane derivatives (C <sub>7+</sub> )		0.8	8.2	22.6

\*Representative of Crude Oil from Tight Formations and Tight Shale Formations.

The development of deep shale oil and gas resources are typically found thousands of feet below the surface of the Earth in tight, low-permeability shale formations. Until recently the vast quantities of natural gas in these formations were thought to be unrecoverable. However,

through the use of hydraulic fracturing, combined with recently improved horizontal drilling techniques, extraordinary amounts of natural gas and crude oil are produced from deep shale formations across the United States.

**Table 2** Comparison of selected properties of crude oils from tight formations (Eagle Ford, Bakken) with conventional light crude oils (Louisiana light sweet crude oil) and brent crude oil.

	Eagle Ford	Bakken	Louisiana light sweet LLS	Brent (North Sea)
API	44–46	42–44	36–38	37–39
Sulfur, % w/w	0.2–0.3	0.05–0.10	0.35–0.45	0.35–0.45
N, ppm	200–400	300–500	900–1200	900–1100
TAN <sup>1</sup>	0.05–0.1	0.01–0.05	0.5–0.6	0.05–0.10
Light ends <sup>2</sup> , % v/v	13–14%	15–16	9–11	10–12
Naphtha, % v/v	22–24	25–27	19–21	19–21
Middle-distillates, % v/v	31–33%	31–32	33–34	29–31
Vacuum gas oil, % v/v	24–26%	22–24	28–29	28–30
Residuum, % v/v	4–6%	3–5	7–9	9–11

<sup>1</sup>TAN: total acid number.

<sup>2</sup>Light ends: low molecular weight organic constituents such as methane, ethane, propane, and butane which are included as components in the oil; in some crude assays, pentane and hexane may be included in the light ends fraction.

**Table 3** Simplified differentiation between conventional crude oil and crude oil from shale formations.

<b>Conventional crude oil</b>
Medium-to-high API gravity
Low-to-medium sulfur content
Mobile in the reservoir
High-permeability reservoir
Primary recovery
Secondary recovery
May use tertiary recovery when reservoir energy is depleted
<b>Tight oil</b>
High API gravity
Low sulfur content
Immobile in the reservoir
Low-to-zero permeability reservoir
Primary, secondary, and tertiary methods of recovery ineffective
Horizontal drilling into reservoir
Fracturing (typically multi-fracturing) to release reservoir fluids

**Table 4** Common characteristics of tight oils.

<i>Advantages</i>
Gravity ranges 40 to 65°API
High yield of distillates
Low sulfur levels
Low levels of nitrogen
High paraffin content
Heavy metals (Ni & V) are low
Low yield of residuum
<i>Disadvantages</i>
Batch to batch variability
Unstable blends when mixed with some crude oils
The presence of hydrogen sulfide can be an issue
High paraffin content
Level of alkaline metals may be high
Other contaminants (Ba, Pb) may be present
Filterable solids: greater volume and smaller particle size
Presence of production chemicals or contaminants.
Low yield of residuum and (therefore) low yield of asphalt

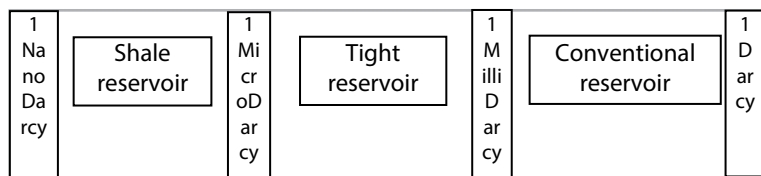

**Figure** Representation of the differences in permeability of shale reservoirs, tight reservoirs, and conventional reservoirs.

## Oil and Gas Originally in Place

The *oil originally in place* (OOIP) is the quantity of petroleum existing in a reservoir before oil recovery operations begin. OOIP is usually reported in the units of stock-tank barrels. A *stock-tank barrel* (stb) refers to a barrel of oil at surface standard conditions (42 US gallons, 5.615 cu. ft.).

A reservoir may contain oil, gas, and water in any combination. Oil originally in place refers to the oil volume present in the reservoir. The oil phase generally coexists with water in the porous reservoir matrix with distributions of the two fluids depending upon the characteristics of the rocks and fluids present. If the reservoir rock is water-wet (i.e., the rock has an affinity for water over oil), the oil resides in the pore bodies and is separated from the rock by a thin film of water. In an oil-wet rock, the oil resides as a thin film on the rock surface and connate water fills the pore bodies. In either case, the oil originally in place resides as a fraction of the pore space with the remaining pore volume occupied by water.

The oil volume calculated using the above equation is expressed as a reservoir volume. Since all crude oils, at the high prevailing pressures and temperatures in reservoirs, contain different amounts of dissolved gas per unit volume, it is more meaningful to express oil volumes at stock tank (surface) conditions, at which the oil and gas will have separated. Thus, the stock tank oil initially in place (STOIP) is:

For oil reservoirs the original oil in place (OOIP) volumetric calculation based on the metric system is:

$$\text{OOIP (m}^3\text{)} = \text{Rock Volume} \times \emptyset \times (1 - S_w) \times 1/B_o$$

where: the rock volume ( $\text{m}^3$ ) is  $10^4 \times A \times h$  –  $A$  is the drainage area, hectares ( $1 \text{ ha} = 10^4 \text{ m}^2$ ),  $h$  is the net pay thickness in meters –  $\emptyset$  is the porosity, which is the fraction of rock volume available to store fluids,  $S_w$  is the volume fraction of porosity that is filled with interstitial water,  $B_o$  is the

formation volume factor ( $\text{m}^3/\text{m}^3$ ) which is a dimensionless factor for the change in oil volume between reservoir conditions and standard conditions at surface,  $1/B_o$  is the shrinkage (stock tank  $\text{m}_3$ /reservoir  $\text{m}^3$ ) is the volume change that the oil undergoes when brought to the surface facilities and is due to solution gas evolving out of the oil.

For oil reservoirs the original oil in place (OOIP) volumetric calculation based on the imperial system is:

$$\text{OOIP (STB)} = \text{rock volume} \times 7,758 \times \emptyset \times (1 - S_w) \times 1/B_o$$

where: the rock volume (acre feet) is  $A \times h$  –  $A$  is the drainage area in acres,  $h$  is the net pay thickness in feet, 7,758 is the factor that converts acre-feet to stock tank barrels,  $\emptyset$  is the porosity, which is the fraction of rock volume available to store fluids,  $S_w$  is the volume fraction of porosity that is filled with interstitial water,  $B_o$  is the formation volume factor (reservoir bbl/STB),  $1/B_o$  is the shrinkage (stb/reservoir bbl).

To convert the estimates to stock tank barrels, the equation is:

$$\text{STOIP} = n = v\phi(1 - S_{wc})/B_{oi}$$

In this equation,  $B_{oi}$  is the oil formation volume factor, under initial conditions,  $V$  is the net bulk volume of the reservoir rock,  $\phi$  is the porosity that is presented as a fractional value,  $S_{wc}$  is the irreducible or connate water saturation (fraction),  $B_{oi}$  is the initial oil formation volume factor (rb/stb), and  $V_b$  denotes the bulk volume of the reservoir and is calculated from estimates of the often complex lateral dimensions and thicknesses of the reservoir. The STOIP value have the units: reservoir volume/stock tank volume, usually, reservoir barrels/stock tank barrel (rb/stb). Thus a volume of  $B_{oi}$  rb of oil will produce one stb of oil at the surface together with the volume of gas which was originally dissolved in the oil in the reservoir.

To calculate recoverable oil volume of oil, the estimate of the original oil in place must be multiplied by the recovery factor. Fluid properties such as formation volume factor, viscosity, density, and solution gas/oil ratio all influence the recovery factor. In addition, it is also a function of the reservoir drive mechanism and the interaction between reservoir rock and the fluids in the reservoir. Some industry standard oil recovery factor ranges for various natural drive mechanisms are: (1) solution gas drive: 2 to 30% v/v, (2) gas cap drive: 30 to 60% v/v, (3) water drive: 2 to 50% v/v, and gravity drive: up to 60% v/v.

For gas reservoirs the original gas-in-place (OGIP) volumetric calculation using the metric system is:

$$\text{OGIP } (10^3\text{m}_3) = \text{rock volume} \times \emptyset \times (1 - s_w) \times (T_s \times P_i) / (P_s \times T_f \times Z_i)$$

where the rock volume ( $\text{m}_3$ ) is  $10_4 \times A \times h - A$  is the drainage area, hectares ( $1 \text{ ha} = 10_4\text{m}_2$ ),  $h$  is the net pay thickness in meters,  $\emptyset$  is the porosity which is the fraction of rock volume that is available to store fluids,  $S_w$  is the volume fraction of porosity filled with interstitial water,  $T_s$  is the base temperature under standard conditions in °Kelvin ( $273^\circ + 15^\circ\text{C}$ ),  $P_s$  is the base pressure under standard conditions (101.35 kPaa),  $T_f$  is the formation temperature in °Kelvin ( $(273^\circ + ^\circ\text{C}$  at formation depth),  $P_i$  is the initial reservoir pressure, kPaa, and  $Z_i$  is the compressibility at  $P_i$  and  $T_f$ .

For gas reservoirs the original gas-in-place (OGIP) volumetric calculation using the imperial system is:

$$\text{OGIP (mmft}^3) = \text{rock volume} \times 43,560 \times \emptyset \times (1 - S_w) \times (T_s \times P_i) / (P_s \times T_f \times Z_i)$$

where: the rock volume (acre feet) is  $A \times h - A$  is the drainage area in acres ( $1 \text{ acre} = 43,560 \text{ sq. ft}$ ),  $h$  is the net pay thickness in feet,  $\emptyset$  is the porosity, which is the fraction of rock volume available to store fluids,  $S_w$  is the volume fraction of porosity that is filled with interstitial water,  $T_s$  is the base temperature under standard conditions in °Rankine ( $460^\circ + 60^\circ\text{F}$ ),  $P_s$  is the base pressure under standard conditions (14.65 psia),  $T_f$  is the formation temperature in °Rankine ( $460^\circ + ^\circ\text{F}$  at formation depth),  $P_i$  is the initial reservoir pressure, psia,  $Z_i$  is the compressibility at  $P_i$  and  $T_f$ . To calculate recoverable gas volumes, the OGIP is multiplied by a recovery factor.

The volumetric depletion of a gas reservoir with reasonable permeability at conventional depths in a conventional area will usually recover 70 to 90% v/v of the gas-in-place. However, the recovery factor for a gas reservoir can be significantly reduced by factors such as: (1) low permeability, (2) low production rate, (3) overpressure, (4) soft sediment compaction, (5) fines migration, (6) excessive formation depth, (7) water influx, water coning and/or behind pipe cross flow, and (8) the position and number of producing wells. As an example, a 60% v/v recovery factor might be appropriate for a gas accumulation overlying a strong aquifer with near perfect pressure support.

# Oil Recovery Factor

Simply, the oil recovery factor (ORF) is the estimate of the recoverable oil (ERO) divided by the estimate of the in-place oil (EIPO):

$$\text{ORF} = \text{ERO}/\text{EIPO}$$

On the other hand, the equation of the stock tank oil initially in place (STOIIP) can be converted into an

equation for calculating the ultimate oil recovery by multiplying by the recovery factor (RF), which is a number between zero and unity representing the fraction of recoverable oil. Thus:

$$\text{Ultimate recovery (UR)} = [(V\phi(1 - S)/B_{oi})] \times \text{RF}$$



# Oil Shale – General Classification

The characteristic, and continuing, feature of oil shale is the presence of kerogen (organic matter) from which oil (shale oil, kerogen oil) is obtained by thermal treatment in the absence of oxygen. Shale oil is the main product of oil shale thermal treatment or processing (sometimes also called retorting). Utilization of oil shale is technically and economically feasible only if at least 20% w/w of the kerogen can be converted into oil by thermal processing. If oil yield is less, one can but talk about some kind of low-kerogen rock and not true oil shale.

Recently, the introduction of the term *shale oil* to define crude oil from tight shale formations is the latest term to add confusion to the system of nomenclature of crude oil-heavy oil-bitumen materials. The term has been used without any consideration of the original term shale oil produced by the thermal decomposition of kerogen in oil shale. Use of the term shale oil in the context of oil from tight formations is not quite analogous, but is certainly similarly confusing, to the term *black oil* that has been used to define crude oil by color rather than by any meaningful properties or recovery behavior.

**Table** Classification of organic-rich shale formations.

Sedimentary rocks	
Non-organic	
Organic rich	
	Humic coal
	Bitumen-containing
	Tar sand (oil sand)
	Oil shale
	Terrestrial
	Cannel coal
	Lacustrine
	Lamosite
	Torbanite
	Marine
	Kukersite
	Marinite
	Tasmanite





# Oilfield Chemicals

Oil field chemicals are generally classified based on type and application. Those on the basis of type include corrosion inhibitor and scale inhibitor, biocides, de-emulsifiers, pour-point depressants (PPD), surfactants, and polymers. Chemicals based on applications include drilling fluid, well stimulation, cementing, and production chemicals.

## *Corrosion Inhibitors and Scale Inhibitors*

Corrosion is an unfortunate reality in nature and has a costly effect on equipment, in particular in oil field operations. Corrosion is the deterioration of a metal as a result of chemical reactions between it and the surrounding environment. It could be simply stated that corrosion of a metal means the loss of electrons by the metal. If we say, for example, that iron metal is corroded, we simply say that the Fe (atom) loses electrons to become an ion; that is, the Fe atom ( $\text{Fe}^0$ ), when it corrodes, is converted to ferrous iron ( $\text{Fe}^{2+}$ ).

A corrosion inhibitor is a substance that when added in small concentration to an environment reduces the corrosion rate of a metal exposed to the environment. In the oil industry, corrosion inhibitors are designed to protect against the following: water, both fresh and brine; biological deposits; carbon dioxide (anaerobic corrosion); and hydrogen sulfide and other organic acids associated with oil operations in all oil-field types. Two types of corrosion inhibitors are generally applied: (1) anodic inhibitors and (2) cathodic inhibitors.

## *Anodic inhibitors*

Anodic inhibitors usually act by forming a protective oxide film on the surface of the metal, causing a large anodic shift of the corrosion potential. This shift causes the metallic surface to move into the passivation region. These inhibitors (*passivators*), chromate derivatives, nitrate derivatives, and molybdate derivatives are examples of anodic inhibitors. *Cathodic inhibitors* act by either slowing the cathodic

reaction itself or selectively precipitating on the cathodic areas in order to limit the diffusion of reducing species to the surface.

## *Biocides*

Biocidal products are defined as active substances and preparations containing one or more active substances put up in the form in which they are supplied to the user, intended to destroy, render harmless, prevent the action of, or otherwise exert a controlling effect on any harmful organism by chemical or biological means. Bactericides are especially used in water injection and produce water treatment where the impurities are separated, and bacteria multiplication is avoided so that the water can be reused without any harm and does not degrade the crude quality.

These products are formulated through a combination of quaternary compounds, fatty acid ethoxylates, and tetrakis hydroxymethyl phosphonium sulfate (THPS) based compounds.

## *De-Emulsifiers*

De-emulsifiers are used for treatment of crude upstream for separation of impurities such as water, heavy salts, and wax. The sludge is biodegradable.

A large amount of petroleum, which is produced from petroleum-bearing formations, is contaminated by water or aqueous solutions of sodium chloride or other salts in emulsified form. Such water-containing systems occur predominantly in the form of water-in-oil emulsions. The natural-occurring emulsifiers in the crude oil have a very complex chemical nature; they differ from one oil well to another and they also depend upon the age of the oil wells, hence to overcome their effect, petroleum emulsion demulsifiers must be selectively developed. In practice, the water is separated by adding to the water-petroleum system very

small amounts of emulsion breaking substances named de-emulsifiers. Alkyl sulfates and alkyl aryl sulfonates, as well as petroleum sulfonates in the form of amino salts, have been proposed for de-emulsification purposes.

The demulsifier concentrations generally range from less than 5 ppm (approximately 1 gal/5000 bbl) to more than 200 ppm (approximately 8 gal/1000 bbl). The most common range is between 10 and 50 ppm. Whatever the demulsifier dosage and range, it may be possible to reduce and optimize the demulsifier usage by evaluating various components in the treatment program.

### *Surfactants*

Surfactants are compounds that lower the surface tension (or interfacial tension) between two liquids or between a liquid and a solid. Surfactants may act as detergents, wetting agents, foaming agents, and dispersants. They are used for corrosion control, foaming, scale control, paraffin dispersants, asphaltene control, and demulsification.

Lauryl alcohol ethoxylates are a special class of nonionic surfactants. It is manufactured by mixing ethylene oxide with fatty alcohols that have alkyl carbon atoms. They have about 12 to 14 lauryl alcohol atoms and are commercially designated by the name LAE. They have high calcium ion tolerance, very high solubility for oily substances, and are

easily biodegradable. They are also hygroscopic, hydrophilic, and lipophilic in nature.

### *Desalting Chemicals*

Desalting chemicals are blends of amines and resins that are used to reduce salt level in crude oil both in upstream and downstream operations. Desalting oil field chemicals are blended with de-emulsifiers for upstream crude treatment. They' are also used in refineries to cut down the salt content in crude oil.

### *Pour Point Depressants*

The pour point of a fuel or oil is the lowest temperature at which it will pour when cooled under defined conditions. In general, the pour point is indicative of the amount of wax in oil. At low temperatures, the wax tends to separate, trapping a substantial amount of oil, inhibiting oil flow. It is also defined as the temperature at which it becomes semisolid and loses its flow characteristics. In crude oil; a high pour point is generally associated with high paraffin content.

Polymethacrylate derivatives are used as viscosity index improvers and pour point depressants. They impart exceptional shear stability and low temperature performance in treated oils. Pour point depressants are essentials to be added for crude oil flow lines all over oil field assets.

# Olamine Processes

The primary process (Figure) for sweetening sour natural gas is quite similar to the processes of glycol dehydration and removal of natural gas liquids by absorption. In this case, however, amine (*olamine*) solutions are used to remove the hydrogen sulfide (the *amine process*). The sour gas is run through a tower, which contains the olamine solution. There are two principle amine solutions used, monoethanolamine (MEA) and diethanolamine (DEA). Either of these compounds, in liquid form, will absorb sulfur compounds from natural gas as it passes through. The effluent gas is virtually free of sulfur compounds, and thus loses its sour gas status. Like the process for the extraction of natural gas liquids and glycol dehydration, the amine solution used can be regenerated for reuse.

Amine derivatives such as ethanolamine (monoethanolamine, MEA), diethanolamine (DEA), triethanolamine (TEA), methyldiethanolamine (MDEA), diisopropanolamine (DIPA), and diglycolamine (DGA) are the most widely used *olamines* in commercial applications (Table) (Katz, 1959; Kohl and Riesenfeld, 1985; Maddox *et al.*, 1985; Polasek and Bullin, 1985; Jou *et al.*, 1985; Pitsinigos and Lygeros, 1989; Speight, 1993; Mokhatab *et al.*, 2006). They are selected according to their relative ability to interact with and remove carbon dioxide and/or hydrogen sulfide.

The chemistry can be represented by simple equations for low partial pressures of the acid gases:

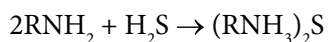

At high acid gas partial pressure, the reactions will lead to the formation of other products:

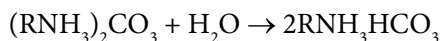
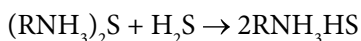

The reaction is extremely fast – the absorption of hydrogen sulfide being limited only by mass transfer; this is not so for carbon dioxide. Regeneration of the solution leads to near complete desorption of carbon dioxide and hydrogen sulfide.

A comparison between monoethanolamine, diethanolamine, and diisopropanolamine shows that monoethanolamine is the cheapest of the three but shows the highest heat of reaction and corrosion; the reverse is true for diisopropanolamine.

The processes using ethanolamine and potassium phosphate are now widely used. The ethanolamine process, known as the *Girbotol* process, removes acid gases (hydrogen sulfide and carbon dioxide) from liquid hydrocarbons as well as from natural and from refinery gases. The *Girbotol* process uses an aqueous solution of ethanolamine ( $\text{H}_2\text{NCH}_2\text{CH}_2\text{OH}$ ) that reacts with hydrogen sulfide at low temperatures and releases hydrogen sulfide at high temperatures. The ethanolamine solution fills a tower called an absorber through which the sour gas is bubbled. Purified gas leaves the top of the tower, and the ethanolamine solution leaves the bottom of the tower with the absorbed acid gases. The ethanolamine solution enters a reactivator tower where heat drives the acid gases from the solution. Ethanolamine solution, restored to its original condition, leaves the bottom of the reactivator tower to go to the top of the absorber tower, and acid gases are released from the top of the reactivator.

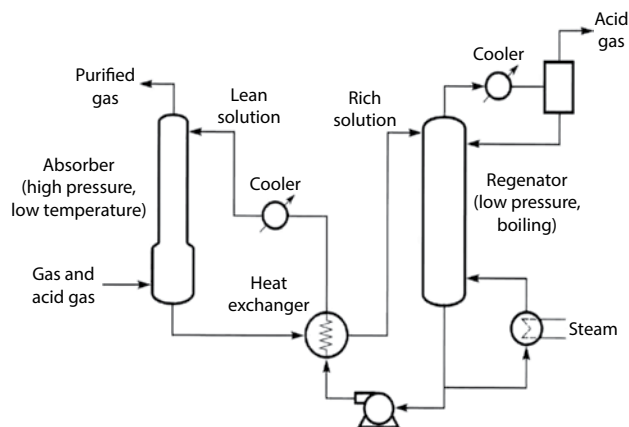

Figure The olamine (Amine) process.

**Table** Oamines used for gas processing.

Oamine	Formula	Derived name	Molecular weight	Specific gravity	Melting point, °C	Boiling point, °C	Flash point, °C	Relative capacity %
Ethanolamine (monoethanolamine)	$\text{HOC}_2\text{H}_4\text{NH}_2$	MEA	61.08	1.01	10	170	85	100
Diethanolamine	$(\text{HOC}_2\text{H}_4)_2\text{NH}$	DEA	105.14	1.097	27	217	169	58
Triethanolamine	$(\text{HOC}_2\text{H}_4)_3\text{N}$	TEA	148.19	1.124	18	335, d	185	41
Diglycolamine (hydroxyethanolamine)	$\text{H}(\text{OC}_2\text{H}_4)_2\text{NH}_2$	DGA	105.14	1.057	-11	223	127	58
Diisopropanolamine	$(\text{HOC}_3\text{H}_6)_2\text{NH}$	DIPA	133.19	0.99	42	248	127	46
Methyldiethanolamine	$(\text{HOC}_2\text{H}_4)_2\text{NCH}_3$	MDEA	119.17	1.03	-21	247	127	51

d: with decomposition.

# Olamine

An olamine (hydroxy-amine) is a compound such as ethanolamine (monoethanolamine, MEA), diethanolamine (DEA), triethanolamine (TEA), methyldiethanolamine (MDEA),

diisopropanolamine (DIPA), and diglycolamine (DGA) that are widely used in gas processing (Table).

**Table** Olamine Derivatives Used for Gas Processing.

Olamine	Formula	Derived name	Molecular weight	Specific gravity	Melting point, C	Boiling point, C	Flash point, C	Relative capacity %
Ethanolamine (monoethanolamine)	$\text{HOC}_2\text{H}_4\text{NH}_2$	MEA	61.08	1.01	10	170	85	100
Diethanolamine	$(\text{HOC}_2\text{H}_4)_2\text{NH}$	DEA	105.14	1.097	27	217	169	58
Triethanolamine	$(\text{HOC}_2\text{H}_4)_3\text{N}$	TEA	148.19	1.124	18	335, d	185	41
Diglycolamine (hydroxyethanolamine)	$\text{H}(\text{OC}_2\text{H}_4)_2\text{NH}_2$	DGA	105.14	1.057	-11	223	127	58
Diisopropanolamine	$(\text{HOC}_3\text{H}_7)_2\text{NH}$	DIPA	133.19	0.99	42	248	127	46
Methyldiethanolamine	$(\text{HOC}_2\text{H}_4)_2\text{NCH}_3$	MDEA	119.17	1.03	-21	247	127	51

d: with decomposition



## On-Stream Factor

The on-stream factor is the fraction of the time that a unit could be expected to operate at design capacity. The on-stream factor affected by (1) operating duration between major turnarounds, (2) unit design, (3) unit life before renewal and retrofiting is needed, (4) operations personnel,

and (in catalytic units) (5) correct catalyst selection and customization in catalyst preparation.

Depending upon the unit and the type of work for which it is designed an on-stream factor of 65 to (at least) 80% is expected.





# Opportunity Crudes

*Opportunity crude oils* are either new crude oils with unknown or poorly understood properties relating to processing issues or are existing crude oils with well-known properties and processing concerns. Opportunity crude oils are often, but not always, heavy crude oils but in either case are more difficult to process due to high levels of solids (and other contaminants) produced with the oil, high levels of acidity, and high viscosity. These crude oils may also be incompatible with other oils in the refinery feedstock blend and cause excessive equipment fouling when processed either in a blend or separately. There is also the need for a refinery to be configured to accommodate *opportunity crude oils* and/or *high-acid crude oils* which, for many purposes, are often included with heavy feedstocks.

Opportunity crudes may have various combinations of high contents of sulfur (>0.7–1.0%), nitrogen, and aromatics; low API gravity (<26–28); an elevated amount of vacuum bottoms; high viscosity; and high acidity with the *total acid number* (TAN) exceeding 0.5 or 1.0 mg KOH/g, depending on the definition used (Table).

The compatibility of opportunity crudes with other opportunity crudes and with conventional crude oil and heavy oil is a very important property to consider when making decisions regarding which crude to purchase. Blending crudes that are incompatible can lead to extensive fouling and processing difficulties because of the unstable asphaltene constituents. These problems can quickly reduce the benefits of purchasing the opportunity crude in the first place. For example, extensive fouling in the crude preheat train may occur resulting in decreased energy efficiency, increased emissions of carbon dioxide, and increased frequency at

which heat exchangers need to be cleaned. In a worst-case scenario, crude throughput may be reduced, leading to significant financial losses.

**Table** General Properties of Crude in the Opportunity Crude Category.

<i>Crude type</i>	<i>Properties</i>	<i>Comments</i>
Heavy sour crude	API: 10–20	Lower yield of distillates Mobile in the reservoir
	>1% w/w sulfur	Higher yield of coke Catalyst poisons Can cause corrosion Can cause fouling
Extra heavy oil	API ca. 10 or less	High yields of resid Mobile in the reservoir
	>2% w/w sulfur	Catalyst contaminants
	High metals content	Fouling problems
	High viscosity	
Tar sand bitumen	API 10 or less	High yields of resid Immobile in the reservoir
	>2% w/w sulfur	Catalyst contaminants
	High metals content	Fouling problems
	High viscosity	
High acid crude	API typically <25	Can cause fouling
	TAN >0.5 mg/gm KOH	Increased corrosion Catalyst destruction Difficult to desalt



# Organic Compounds – Physical and Thermochemical Data

$H_c^\circ$	Standard molar enthalpy change of combustion at 298 K
$H_f^\circ$	Standard molar enthalpy change of formation at 298 K
$G_f^\circ$	Standard molar Gibbs free energy change of formation at 298 K
$S^\circ$	Standard molar entropy at 298 K. Chosen standard pressure is 1 atm

Compound	Formula	M g mol <sup>-1</sup>	H <sub>c</sub> <sup>o</sup> kJ mol <sup>-1</sup>	H <sub>f</sub> <sup>o</sup> kJ mol <sup>-1</sup>	G <sub>f</sub> <sup>o</sup> kJ mol <sup>-1</sup>	S <sup>o</sup> J mol <sup>-1</sup> K <sup>-1</sup>
Carbon monoxide	CO <sub>(g)</sub>	28.0	-283.0	-110.5	-137.23	197.6
Carbon dioxide	CO <sub>2(g)</sub>	44.0	-----	-393.5	-394.4	213.6
<i>Alkanes</i>						
Methane	CH <sub>4(g)</sub>	16.0	-890.3	-74.8	-50.8	186.2
Ethane	CH <sub>3</sub> CH <sub>3(g)</sub>	30.1	-1559.7	-84.7	-32.9	229.5
Propane	CH <sub>3</sub> CH <sub>2</sub> CH <sub>3(g)</sub>	44.1	-2219.2	-104.5	-23.4	269.9
Butane	CH <sub>3</sub> (CH <sub>2</sub> ) <sub>2</sub> CH <sub>3(g)</sub>	58.1	-2876.5	-126.5	-15.6	310.1
Pentane	CH <sub>3</sub> (CH <sub>2</sub> ) <sub>3</sub> CH <sub>3(g)</sub>	72.2	-3509.1	-173.2	-9.2	261.2
Hexane	CH <sub>3</sub> (CH <sub>2</sub> ) <sub>4</sub> CH <sub>3(g)</sub>	86.2	-4163.0	-198.6	-4.2	295.9
Heptane	CH <sub>3</sub> (CH <sub>2</sub> ) <sub>5</sub> CH <sub>3(g)</sub>	100.2	-4816.0	-224.0	1.3	328.5
Octane	CH <sub>3</sub> (CH <sub>2</sub> ) <sub>6</sub> CH <sub>3(g)</sub>	114.2	-5470.2	-250.0	6.4	361.1
Nonane	CH <sub>3</sub> (CH <sub>2</sub> ) <sub>7</sub> CH <sub>3(g)</sub>	128.3	-6124.6	-274.0	11.9	393.7
Decane	CH <sub>3</sub> (CH <sub>2</sub> ) <sub>8</sub> CH <sub>3(g)</sub>	142.3	-6777.9	-300.9	17.4	425.9
Undecane	CH <sub>3</sub> (CH <sub>2</sub> ) <sub>9</sub> CH <sub>3(g)</sub>	156.3	-7430.9	-327.2	22.8	-----
Dodecane	CH <sub>3</sub> (CH <sub>2</sub> ) <sub>10</sub> CH <sub>3(g)</sub>	170.3	-8086.5	-350.9	28.4	-----
Eicosane	CH <sub>3</sub> (CH <sub>2</sub> ) <sub>18</sub> CH <sub>3(g)</sub>	282.6				
<i>Branched Alkanes</i>						
2-Methylpropane	(CH <sub>3</sub> ) <sub>2</sub> CHCH <sub>3(g)</sub>	58.1	-2868.5	-134.5	-17.8	294.6
2-Methylbutane	(CH <sub>3</sub> ) <sub>2</sub> CHCH <sub>2</sub> CH <sub>3(g)</sub>	72.2	-3503.4	-178.9	-14.5	260.4
2-Methylpentane	(CH <sub>3</sub> ) <sub>2</sub> CH(CH <sub>2</sub> ) <sub>2</sub> CH <sub>3(g)</sub>	86.2	-4157.0	-204.6	-8.1	-----
2-Methylhexane	(CH <sub>3</sub> ) <sub>2</sub> CH(CH <sub>2</sub> ) <sub>3</sub> CH <sub>3(g)</sub>	100.2	-4811.4	-229.5	-2.0	-----
2-Methylheptane	(CH <sub>3</sub> ) <sub>2</sub> CH(CH <sub>2</sub> ) <sub>4</sub> CH <sub>3(g)</sub>	114.2	-5465.2	-255.0	3.8	-----
2,2-Dimethylpropane	C(CH <sub>3</sub> ) <sub>4(g)</sub>	72.2	-3492.5	-189.8	-15.2	306.4
<i>Cycloalkanes</i>						
Cyclopropane	(CH <sub>2</sub> ) <sub>3(g)</sub>	42.1		-2091.4	53.3	-----
Cyclobutane	(CH <sub>2</sub> ) <sub>4(g)</sub>	56.1		-2720.9	3.7	-----
Cyclopentane	(CH <sub>2</sub> ) <sub>5(g)</sub>	70.1		-3289.4	-107.1	204.3
Cyclohexane	(CH <sub>2</sub> ) <sub>6(g)</sub>	84.2		-3919.5	-156.3	204.4
Cycloheptane	(CH <sub>2</sub> ) <sub>7(g)</sub>	98.2		-4598.4	-156.7	-----
Cyclooctane	(CH <sub>2</sub> ) <sub>8(g)</sub>	112.2		-5266.7	-167.7	-----
Cyclononane	(CH <sub>2</sub> ) <sub>9(g)</sub>	126.2		-5932.5	-181.2	-----

<i>Alkenes</i>									
Ethene	$\text{CH}_2=\text{CH}_{2(g)}$	28.1	-1410.8	52.5	68.2	219.5			
Propene	$\text{CH}_2=\text{CH}_2\text{CH}_{3(g)}$	42.1	-2058.1	20.2	74.7	266.9			
But-1-ene	$\text{CH}_2=\text{CHCH}_2\text{CH}_{3(g)}$	56.1	-2716.8	-0.4	72.0	305.6			
<i>trans</i> -But-2-ene	$\text{CH}_3\text{CH}=\text{CHCH}_{3(g)}$	56.1	-2705.0	-12.2	62.9	296.4			
<i>cis</i> -But-2-ene	$\text{CH}_3\text{CH}=\text{CHCH}_{3(g)}$	56.1	-2709.4	-7.8	65.9	300.8			
Hex-1-ene	$\text{CH}_2=\text{CH}(\text{CH}_2)_3\text{CH}_{3(g)}$	84.2	-4003.4	-72.4	-----	-----			
Buta-1,2-diene	$\text{CH}_2=\text{C}=\text{CHCH}_{3(g)}$	54.1	-2593.7	162.3	201.5	293.0			
Buta-1,3-diene	$\text{CH}_2=\text{C}=\text{CHCH}_{3(g)}$	54.1	-2541.3	109.9	151.9	278.7			
Cyclohexene	$\text{CH}_2(\text{CH}_2)_3\text{CH}=\text{CH}_{2(g)}$	81.2	-3751.9	-38.1	-----	-----			
Phenylethene (styrene)	$\text{C}_6\text{H}_5\text{CH}=\text{CH}_{2(g)}$	104.2	-4395.0	103.8	202.5	345.1			
<i>Alkynes</i>									
Ethyne	$\text{CHCH}_{(g)}$	26.0	-1300.8	228.0	209.2	200.8			
Propyne	$\text{CH}_3\text{CHCH}_{(g)}$	40.1	-1938.7	186.6	194.2	248.1			
1-Butyne	$\text{CH}_3\text{CH}_2\text{CCH}_{(g)}$	54.1	-2596.6	165.2	203.1	-----			
2-Butyne	$\text{CH}_3\text{CCCH}_{3(g)}$	54.1	-2576.8	118.8	187.2	-----			
<i>Arenes</i>									
Benzene	$\text{C}_6\text{H}_{6(g)}$	78.1	-3267.4	49.0	124.5	172.8			
Napthalene	$\text{C}_{10}\text{H}_{8(g)}$	128.2	-5155.9	77.7	-----	-----			
Methylbenzene	$\text{C}_6\text{H}_5\text{CH}_{3(g)}$	92.1	-3909.8	12.1	110.6	319.7			
Ethylbenzene	$\text{C}_6\text{H}_5\text{CH}_2\text{CH}_{3(g)}$	106.2	-4563.9	-13.1	19.7	255.2			
Propylbenzene	$\text{C}_6\text{H}_5(\text{CH}_2)_2\text{CH}_{3(g)}$	120.2	-5218.0	-38.3	123.8	290.5			
1,2-Dimethylbenzene	$\text{C}_6\text{H}_4(\text{CH}_3)_2(g)$	106.2	-4552.6	-24.4	110.6	246.5			
1,3-Dimethylbenzene	$\text{C}_6\text{H}_4(\text{CH}_3)_2(g)$	106.2	-4551.6	-25.4	107.8	252.1			
1,4-Dimethylbenzene	$\text{C}_6\text{H}_4(\text{CH}_3)_2(g)$	106.2	-4552.6	-24.4	110.3	247.2			
Ethenylbenzene (vinyl)	$\text{C}_6\text{H}_5\text{CH}=\text{CH}_{2(g)}$	104.2	-4395.0	103.8	202.5	345.1			
<i>Amines</i>									
Methylamine	$\text{CH}_3\text{NH}_{2(g)}$		-1085.0	-23.0	32.1	-----			
Dimethylamine	$(\text{CH}_3)_2\text{NH}_{(g)}$		-1768.8	-18.5	59.2	-----			
Trimethylamine	$(\text{CH}_3)_3\text{N}_{(g)}$		-2442.9	-23.7	76.7	-----			
Ethylamine	$\text{CH}_3\text{CH}_2\text{NH}_{2(g)}$		-1739.8	-47.5	-----	-----			
1-Aminopropane	$\text{CH}_3(\text{CH}_2)_2\text{NH}_{2(g)}$		-2365.1	-101.5	-----	-----			
2-Aminopropane	$\text{CH}_3\text{CHNH}_2\text{CH}_{3(g)}$		-2354.3	-112.3	-----	-----			
1-Aminobutane	$\text{CH}_3(\text{CH}_2)_3\text{NH}_{2(g)}$		-3018.3	-127.6	-81.8	-----			

Compound	Formula	M g mol <sup>-1</sup>	H <sub>c</sub> kJ mol <sup>-1</sup>	H <sub>f</sub> kJ mol <sup>-1</sup>	H <sub>f</sub> kJ mol <sup>-1</sup>	G <sub>f</sub> kJ mol <sup>-1</sup>	S <sup>o</sup> J mol <sup>-1</sup> K <sup>-1</sup>
2-Aminobutane	CH <sub>3</sub> CH <sub>2</sub> CHNH <sub>2</sub> CH <sub>3</sub> (30)		73.1	-3008.4	-137.5	-----	-----
Diethylamine	(C <sub>2</sub> H <sub>5</sub> ) <sub>2</sub> NH(10)		73.1	-3042.1	-103.8	-----	-----
Triethylamine	(C <sub>2</sub> H <sub>5</sub> ) <sub>3</sub> N(10)		101.2	-4376.8	-127.7	-----	-----
Phenylamine	C <sub>6</sub> H <sub>5</sub> NH <sub>2</sub> (10)		93.1	-3392.6	31.3	-----	-----
<i>Halogens</i>							
Fluoromethane	CH <sub>3</sub> F <sub>(6)</sub>		34.0	-----	-247.0	-223.0	-----
Chloromethane	CH <sub>3</sub> Cl <sub>(6)</sub>		50.5	-764.0	-82.0	-57.4	234.5
Bromomethane	CH <sub>3</sub> Br <sub>(6)</sub>		94.9	-769.9	-37.2	-25.9	246.3
Iodomethane	CH <sub>3</sub> I <sub>(6)</sub>		141.9	-814.6	-15.5	13.4	163.2
Dichloromethane	CH <sub>2</sub> Cl <sub>2</sub> (20)		84.9	-605.8	-124.1	-63.2	177.8
Trichloromethane	CHCl <sub>3</sub> (30)		119.4	-474.0	-135.1	-71.4	201.8
Tetrachloromethane	CCl <sub>4</sub> (40)		153.8	-359.9	-129.6	-65.3	216.4
Tetrabromomethane	CBr <sub>4</sub> (6)		331.6	-----	18.8	47.7	212.5
Tetraiodomethane	CI <sub>4</sub> (6)		519.6	-----	-----	-----	-----
Chloroethane	CH <sub>3</sub> CH <sub>2</sub> Cl <sub>(6)</sub>		64.5	-1413.1	-136.8	-52.9	-----
Bromoethane	CH <sub>3</sub> CH <sub>2</sub> Br <sub>(10)</sub>		109.0	-1424.7	-90.5	-----	-----
Iodoethane	CH <sub>3</sub> CH <sub>2</sub> I <sub>(10)</sub>		156.0	-1466.5	-40.7	-----	-----
1,2-Dibromoethane	CH <sub>2</sub> BrCH <sub>2</sub> Br <sub>(10)</sub>		187.9	-----	-37.8	-80.7	-----
1,2-Dichloroethane	CH <sub>2</sub> ClCH <sub>2</sub> Cl <sub>(10)</sub>		99.9	-1246.4	-165.0	-----	-----
1,1,1-Trichloroethane	CCl <sub>3</sub> CH <sub>3</sub> (30)		133.4	-1108.0	-177.3	-----	-----
Tetrachloroethene	C <sub>2</sub> Cl <sub>4</sub> (40)		165.8	-830.9	-48.6	-----	-----
1-Chloropropane	CH <sub>3</sub> CH <sub>2</sub> CH <sub>2</sub> Cl <sub>(10)</sub>		78.5	-2072.1	-161.3	-----	-----
2-Chloropropane	CH <sub>3</sub> CHClCH <sub>3</sub> (30)		78.5	-2028.4	-172.2	-----	-----
1-Bromopropane	CH <sub>3</sub> CH <sub>2</sub> CH <sub>2</sub> Br <sub>(10)</sub>		123.0	-2056.8	-116.4	-----	-----
2-Bromopropane	CH <sub>3</sub> CHBrCH <sub>3</sub> (30)		123.0	-2052.0	-128.5	-----	-----
1-Iodopropane	CH <sub>3</sub> CH <sub>2</sub> CH <sub>2</sub> I <sub>(10)</sub>		170.0		-----	-68.4	-----
2-Iodopropane	CH <sub>3</sub> CHICH <sub>3</sub> (30)		170.0		-----	-75.7	-----
1-Chlorobutane	CH <sub>3</sub> (CH <sub>2</sub> ) <sub>3</sub> Cl <sub>(10)</sub>		92.6	-2704.1	-2704.1	-187.9	-----
1-Bromobutane	CH <sub>3</sub> (CH <sub>2</sub> ) <sub>3</sub> Br <sub>(10)</sub>		137.0	-2716.5	-2716.5	-143.8	-----
2-Bromobutane	CH <sub>3</sub> CH <sub>2</sub> CHBrCH <sub>3</sub> (30)		137.0	-2705.2	-2705.2	-155.2	-----
1-Iodobutane	CH <sub>3</sub> (CH <sub>2</sub> ) <sub>3</sub> I <sub>(10)</sub>		184.0		-----	-----	-----
2-Chloro-2-methylpropane	(CH <sub>3</sub> ) <sub>3</sub> CClCH <sub>3</sub> (30)		92.6	-2692.8	-2692.8	-191.1	-----
2-Bromo-2-methylpropane	(CH <sub>3</sub> ) <sub>3</sub> CBrCH <sub>3</sub> (30)		137.0		-----	-163.4	-----

2-Iodo-2-methylpropane	(CH <sub>3</sub> ) <sub>2</sub> CI(CH <sub>3</sub> ) <sub>30</sub>	184.0	-----	-107.4	-----	-----
Chlorobenzene	C <sub>6</sub> H <sub>5</sub> Cl <sub>(0)</sub>	112.6	-3111.6	11.0	93.6	-----
Bromobenzene	C <sub>6</sub> H <sub>5</sub> Br <sub>(0)</sub>	157.6	-----	60.5	112.2	-----
Iodobenzene	C <sub>6</sub> H <sub>5</sub> I <sub>(0)</sub>	204.6	-3192.8	14.5	208.0	-----
Chloro-methyl-benzene	C <sub>6</sub> H <sub>5</sub> CH <sub>2</sub> Cl <sub>(0)</sub>	126.6	-3708.7	-32.8	-----	-----
<i>Alcohols</i>						
Methanol	CH <sub>3</sub> OH <sub>(0)</sub>	32.0	-726.0	-239.1	-166.4	239.7
Ethanol	CH <sub>3</sub> CH <sub>2</sub> OH <sub>(0)</sub>	46.1	-1367.3	-277.1	-174.9	160.7
Propan-1-ol	CH <sub>3</sub> CH <sub>2</sub> CH <sub>2</sub> OH <sub>(0)</sub>	60.1	-2021.0	-302.7	-171.3	196.6
Propan-2-ol	CH <sub>3</sub> CHOHCH <sub>3(0)</sub>	60.1	-2005.8	-317.9	-180.3	180.5
Butan-1-ol	CH <sub>3</sub> (CH <sub>2</sub> ) <sub>2</sub> CH <sub>2</sub> OH <sub>(0)</sub>	74.1	-2675.6	-327.4	-168.9	228.0
Pentan-1-ol	CH <sub>3</sub> (CH <sub>2</sub> ) <sub>3</sub> CH <sub>2</sub> OH <sub>(0)</sub>	88.2	-3328.7	-353.6	-163.3	259.0
Hexan-1-ol	CH <sub>3</sub> (CH <sub>2</sub> ) <sub>4</sub> CH <sub>2</sub> OH <sub>(0)</sub>	102.2	-3983.8	-377.8	-160.0	289.5
Heptan-1-ol	CH <sub>3</sub> (CH <sub>2</sub> ) <sub>5</sub> CH <sub>2</sub> OH <sub>(0)</sub>	116.2	-4637.6	-403.3	-150.0	325.9
Octan-1-ol	CH <sub>3</sub> (CH <sub>2</sub> ) <sub>6</sub> CH <sub>2</sub> OH <sub>(0)</sub>	130.2	-5293.6	-426.6	-136.4	354.4
Ethan-1,2-diol	CH <sub>2</sub> OHCH <sub>2</sub> OH <sub>(0)</sub>	62.1	-1179.5	-454.8	-323.2	166.9
Propan-1,2,3-triol	CH <sub>2</sub> OHCHOHCH <sub>2</sub> OH <sub>(0)</sub>	92.1	-1655.2	-688.5	-----	-----
2-Methylpropan-2-ol	(CH <sub>3</sub> ) <sub>3</sub> COH <sub>(0)</sub>	74.1	-2643.8	-359.2	-----	-----
Cyclohexanol	CH <sub>2</sub> (CH <sub>2</sub> ) <sub>4</sub> CHOH <sub>(0)</sub>	100.2	-3737.0	-348.8	-1134.2	-----
<i>Ethers</i>						
Methoxymethane	CH <sub>3</sub> OCH <sub>3(0)</sub>	46.1	-1460.4	-184.0	-114.1	266.7
Ethoxyethane	CH <sub>3</sub> CH <sub>2</sub> OCH <sub>2</sub> CH <sub>3(0)</sub>	74.1	-2724.0	-279.0	-122.7	251.9
Methoxybenzene	C <sub>6</sub> H <sub>5</sub> OCH <sub>3(0)</sub>	108.1	-3782.9	-114.8	-----	-----
<i>Aldehydes</i>						
Methanal	HCHO <sub>(0)</sub>	30.0	-570.6	-108.7	-113.0	218.7
Ethanal	CH <sub>3</sub> CHO <sub>(0)</sub>	44.1	-1167.1	-191.5	-128.2	160.2
Propanal	CH <sub>3</sub> CH <sub>2</sub> CHO <sub>(0)</sub>	58.1	-1820.8	-217.1	-142.1	-----
Butanal	CH <sub>3</sub> CH <sub>2</sub> CH <sub>2</sub> CHO <sub>(0)</sub>	72.1	-2476.0	-241.2	-306.4	-----
2-Methylpropanal	(CH <sub>3</sub> ) <sub>2</sub> CHCHO <sub>(0)</sub>	72.1	-2468.3	-248.9	-----	-----
Pentanal	CH <sub>3</sub> CH <sub>2</sub> CH <sub>2</sub> CH <sub>2</sub> CHO <sub>(0)</sub>	86.1	-3166.0	-230.5	-----	-----
Benzaldehyde	C <sub>6</sub> H <sub>5</sub> CHO <sub>(0)</sub>	106.1	-3525.1	-86.8	-----	-----
<i>Ketones</i>						
Propanone (acetone)	CH <sub>3</sub> COCH <sub>3(0)</sub>	58.1	-1816.5	-248.0	-154.0	-----
Butanone	CH <sub>3</sub> CH <sub>2</sub> COCH <sub>3(0)</sub>	72.1	-2441.5	-275.7	-156.0	-----

Pentan-2-one	$\text{CH}_3(\text{CH}_2)_2\text{COCH}_3$	86.1	-3099.1	-297.4	-----	-----
Pentan-3-one	$\text{CH}_3\text{CH}_2\text{COCH}_2\text{CH}_3$	86.1	-3099.5	-297.0	-----	-----
3-Methylbutanone	$(\text{CH}_3)_2\text{CHCOCH}_3$	86.1	-3097.0	-299.5	-----	-----
Hexan-2-one	$\text{CH}_3(\text{CH}_2)_3\text{COCH}_3$	100.2	-3753.8	-322.0	-----	-----
Cyclohexanone	$\text{CH}_2(\text{CH}_2)_4\text{CO}$	98.1	-3519.3	-270.7	-----	-----
Phenylethanone	$\text{C}_6\text{H}_5\text{COCH}_3$	120.2	-4148.7	-142.5	-----	-----
<i>Carboxylic Acids</i>						
Methanoic	$\text{HCOOH}$	46.0	-254.3	-425.0	-361.4	129.0
Ethanoic	$\text{CH}_3\text{COOH}$	60.1	-874.1	-484.5	-389.9	159.8
Propanoic	$\text{CH}_3\text{CH}_2\text{COOH}$	74.1	-1527.2	-510.7	-383.5	-----
Butanoic	$\text{CH}_3\text{CH}_2\text{CH}_2\text{COOH}$	88.1	-2183.3	-533.9	-----	-----
2-Methylpropanoic	$(\text{CH}_3)_2\text{CHCOOH}$	88.1	-2343.9	-373.3	-----	-----
3-Chloroethanoic	$\text{ClCH}_2\text{COOH}$	94.5	-715.5	-----	-----	-----
3,3-Dichloroethanoic	$\text{Cl}_2\text{CHCO}_2\text{H}$	128.9	-----	-----	-----	-----
3,3,3-Trichloroethanoic	$\text{Cl}_3\text{CCOOH}$	163.4	-388.5	-513.8	-----	-----
1-Aminoethanoic	$\text{NH}_2\text{CH}_2\text{COOH}$	75.1	-981.1	-528.6	-----	-----
2-Hydroxypropanoic (lactic)	$\text{CH}_3\text{CHOHCOOH}$	90.1	-1343.9	-694.0	-----	-----
Ethandioic	$\text{COOHCOOH}$	90.0	-243.3	-829.5	-----	-----
Hexanedioic	$\text{CO}_2\text{H}(\text{CH}_2)_4\text{CO}_2\text{H}$	146.1	-2795.7	-994.0	-----	-----
Benzenesulphonic	$\text{C}_6\text{H}_5\text{SO}_3\text{H}$	158.1	-----	-----	-----	-----
Benzoic	$\text{C}_6\text{H}_5\text{COOH}$	122.1	-3227.0	-384.9	-245.1	-----
<i>Acid Derivatives</i>						
Ethanoic chloride	$\text{CH}_3\text{COCl}$	78.5	-----	-272.9	-208.0	200.8
Ethanoic bromide	$\text{CH}_3\text{COBr}$	123.0	-----	-223.5	-----	-----
Ethanoic iodide	$\text{CH}_3\text{COI}$	170.0	-----	-163.5	-----	-----
Ethanimide (acetamide)	$\text{CH}_3\text{CONH}_2$	59.1	-1184.6	-317.0	-----	-----
Phenylethanamide	$\text{CH}_2\text{CONHC}_6\text{H}_5$	135.2	-4224.9	-209.2	-----	-----
Ethanoic anhydride	$\text{CH}_3\text{CH}_2\text{COOCH}_2\text{CH}_3$	102.1	-1794.2	-637.2	-----	-----
<i>Esters</i>						
Methyl methanoate	$\text{HCOOCH}_3$	60.1	-972.5	-386.1	-----	-----
Methyl ethanoate	$\text{CH}_3\text{COOCH}_3$	74.1	-1592.1	-445.8	-----	-----
Methyl propanoate	$\text{CH}_3\text{CH}_2\text{COOCH}_3$	88.1	-2245.6	-471.6	-----	-----
Ethyl methanoate	$\text{HCO}_2\text{CH}_2\text{CH}_3$	74.1	-----	-371.0	-----	-----
Ethyl ethanoate	$\text{CH}_3\text{CO}_2\text{CH}_2\text{CH}_3$	88.1	-2237.9	-479.0	-----	-----



Ethyl propanoate	$\text{CH}_3\text{CH}_2\text{COOCH}_2\text{CH}_3$ <sup>(30)</sup>	102.1	-2893.8	-502.7	-----
Ethyl 3-oxo-butanoate	$\text{CH}_3\text{COOCH}_2\text{COOC}_2\text{H}_5$ <sup>(30)</sup>	130.1	-2890.3	-506.2	-----
<i>Nitriles</i>					
Ethanenitrile	$\text{CH}_3\text{CN}$ <sup>(0)</sup>	41.1	-1247.1	31.4	-----
Propanenitrile	$\text{CH}_3\text{CH}_2\text{CN}$ <sup>(0)</sup>	55.1	-1910.5	15.5	-----
Butanenitrile	$\text{CH}_3(\text{CH}_2)_2\text{CN}$ <sup>(0)</sup>	69.1	-2568.2	-5.8	-----
Propanenitrile	$\text{CH}_2=\text{CHCN}$ <sup>(0)</sup>	53.1	-1756.4	147.2	-----
<i>Miscellaneous</i>					
Carbamide (urea)	$\text{NH}_2\text{CONH}_2$ <sup>(6)</sup>	60.1	-632.2	-332.9	-196.8
Cyclooctatetraene	$\text{C}_8\text{H}_8$ <sup>(80)</sup>	104.2	-4545.7	254.5	358.1
1,2-Epoxyethane	$\text{C}_2\text{H}_4\text{O}$ <sup>(0)</sup>	44.1	-1262.9	-77.6	-----
1,2-Epoxypropane	$\text{CH}_3\text{CHCH}_2\text{O}$ <sup>(0)</sup>	58.1	-1917.4	-122.6	-----
Furan	$(\text{CH})_4\text{O}$ <sup>(0)</sup>	68.1	-2083.2	-62.3	-----
Nitrobenzene	$\text{C}_6\text{H}_5\text{NO}_2$ <sup>(20)</sup>	123.1	-3087.9	12.4	141.6
Phenol	$\text{C}_6\text{H}_5\text{OH}$ <sup>(6)</sup>	94.1	-3053.4	-165.0	-47.5
Pyridine	$(\text{CH})_5\text{N}$ <sup>(6)</sup>	79.1	-2783.2	101.2	181.2
Thiocarbamide	$\text{NH}_2\text{CSNH}_2$ <sup>(6)</sup>	76.1	-----	-93.0	-----
Fructose	$\text{C}_6\text{H}_{12}\text{O}_6$ <sup>(6)</sup>	180.2	-2810.2	-1265.6	-----
Glucose	$\text{C}_6\text{H}_{12}\text{O}_6$ <sup>(6)</sup>	180.2	-2902.5	-1273.3	-----
Sucrose	$\text{C}_{12}\text{H}_{22}\text{O}_{11}$ <sup>(6)</sup>	342.3	-5639.7	-2226.1	-----



# Organic Solvents

Solvents are liquids or gases that can dissolve or extract other substances and are an essential part of laboratory operations – typically for use to dissolve substances or for cleaning – and must be used with caution. Solvents are used to dissolve materials such as grease, oil, and paint; to thin or mix pigments, paint, glue, and pesticides.

The term *solvents* usually refers to organic solvents, which contain carbon and can be classified into three main

types: (1) hydrocarbon solvents, (2) oxygenated solvents, and (3) halogenated solvents. Hydrocarbon solvents contain hydrogen and are derived mainly from petroleum while oxygenated solvents are synthesized from other chemicals. Halogenated solvents contain one or more of the halogen elements: chlorine, bromine, fluorine, or iodine.

In the interests of safety and health, the properties of any solvent must be determined before use.

**Table** Properties of common organic solvents.

Solvent	Formula	Molecular weight	Boiling point degrees C	Melting point degrees C	Density g/ml	Solubility in water g/100 ml water	Dielectric constant	Flash point degrees C
acetic acid	C <sub>2</sub> H <sub>4</sub> O <sub>2</sub>	60.052	118	16.6	1.0446	Miscible	6.2	39
acetone	C <sub>3</sub> H <sub>6</sub> O	58.079	56.05	-94.7	0.7845	Miscible	21.01	-20
acetonitrile	C <sub>2</sub> H <sub>3</sub> N	41.052	81.65	-43.8	0.7857	Miscible	36.64	6
benzene	C <sub>6</sub> H <sub>6</sub>	78.11	80.1	5.5	0.8765	0.18	2.28	-11
1-butanol	C <sub>4</sub> H <sub>10</sub> O	74.12	117.7	-88.6	0.8095	6.3	17.8	37
2-butanol	C <sub>4</sub> H <sub>10</sub> O	74.12	99.5	-88.5	0.8063	15	17.26	24
2-butanone	C <sub>4</sub> H <sub>8</sub> O	72.11	79.6	-86.6	0.7999	25.6	18.6	-9
<i>t</i> -butyl alcohol	C <sub>4</sub> H <sub>10</sub> O	74.12	82.4	25.7	0.7887	Miscible	12.5	11
carbon tetrachloride	CCl <sub>4</sub>	153.82	76.8	-22.6	1.594	0.08	2.24	-
chlorobenzene	C <sub>6</sub> H <sub>5</sub> Cl	112.56	131.7	-45.3	1.1058	0.05	5.69	28
chloroform	CHCl <sub>3</sub>	119.38	61.2	-63.4	1.4788	0.795	4.81	-
cyclohexane	C <sub>6</sub> H <sub>12</sub>	84.16	80.7	6.6	0.7739	<0.1	2.02	-20
1,2-dichloroethane	C <sub>2</sub> H <sub>4</sub> Cl <sub>2</sub>	98.96	83.5	-35.7	1.245	0.861	10.42	13
diethylene glycol	C <sub>4</sub> H <sub>10</sub> O <sub>3</sub>	106.12	246	-10	1.1197	10	31.8	124
diethyl ether	C <sub>4</sub> H <sub>10</sub> O	74.12	34.5	-116.2	0.713	7.5	4.267	-45
diglyme (diethylene glycol dimethyl ether)	C <sub>6</sub> H <sub>14</sub> O <sub>3</sub>	134.17	162	-68	0.943	Miscible	7.23	67
dimethyl-formamide (DMF)	C <sub>3</sub> H <sub>7</sub> NO	73.09	153	-60.48	0.9445	Miscible	38.25	58

(Continued)

Table Cont.

Solvent	Formula	Molecular weight	Boiling point degrees C	Melting point degrees C	Density g/ml	Solubility in water g/100 ml water	Dielectric constant	Flash point degrees C
dimethyl sulfoxide (DMSO)	C <sub>2</sub> H <sub>6</sub> OS	78.13	189	18.4	1.092	25.3	47	95
1,4-dioxane	C <sub>4</sub> H <sub>8</sub> O <sub>2</sub>	88.11	101.1	11.8	1.033	Miscible	2.21(25)	12
ethanol	C <sub>2</sub> H <sub>6</sub> O	46.07	78.5	-114.1	0.789	Miscible	24.6	13
ethyl acetate	C <sub>4</sub> H <sub>8</sub> O <sub>2</sub>	88.11	77	-83.6	0.895	8.7	6(25)	-4
ethylene glycol	C <sub>2</sub> H <sub>6</sub> O <sub>2</sub>	62.07	195	-13	1.115	Miscible	37.7	111
glycerin	C <sub>3</sub> H <sub>8</sub> O <sub>3</sub>	92.09	290	17.8	1.261	Miscible	42.5	160
heptane	C <sub>7</sub> H <sub>16</sub>	100.2	98	-90.6	0.684	0.01	1.92	-4
hexane	C <sub>6</sub> H <sub>14</sub>	86.18	69	-95	0.659	0.014	1.89	-22
methanol	CH <sub>4</sub> O	32.04	64.6	-98	0.791	Miscible	32.6(25)	12
methylene chloride	CH <sub>2</sub> Cl <sub>2</sub>	84.93	39.8	-96.7	1.326	1.32	9.08	1.6
N-methyl-2-pyrrolidinone (NMP)	CH <sub>5</sub> H <sub>9</sub> NO	99.13	202	-24	1.033	10	32	91
nitromethane	CH <sub>3</sub> NO <sub>2</sub>	61.04	101.2	-29	1.382	9.5	35.9	35
pentane	C <sub>5</sub> H <sub>12</sub>	72.15	36.1	-129.7	0.626	0.04	1.84	-49
Petroleum ether (ligroine)	-	-	30-60	-40	0.656	-	-	-30
1-propanol	C <sub>3</sub> H <sub>8</sub> O	88.15	97	-126	0.803	Miscible	20.1(25)	15
2-propanol	C <sub>3</sub> H <sub>8</sub> O	88.15	82.4	-88.5	0.785	Miscible	18.3(25)	12
pyridine	C <sub>5</sub> H <sub>5</sub> N	79.1	115.2	-41.6	0.982	Miscible	12.3(25)	17
tetrahydrofuran (THF)	C <sub>4</sub> H <sub>8</sub> O	72.106	65	-108.4	0.8833	30	7.52	-14
toluene	C <sub>7</sub> H <sub>8</sub>	92.14	110.6	-93	0.867	0.05	2.38(25)	4
triethyl amine	C <sub>6</sub> H <sub>15</sub> N	101.19	88.9	-114.7	0.728	0.02	2.4	-11
water	H <sub>2</sub> O	18.02	100	0	0.998	-	78.54	-
water, heavy	D <sub>2</sub> O	20.03	101.3	4	1.107	Miscible	??	-
<i>o</i> -xylene	C <sub>8</sub> H <sub>10</sub>	106.17	144	-25.2	0.897	Insoluble	2.57	32
<i>m</i> -xylene	C <sub>8</sub> H <sub>10</sub>	106.17	139.1	-47.8	0.868	Insoluble	2.37	27
<i>p</i> -xylene	C <sub>8</sub> H <sub>10</sub>	106.17	138.4	13.3	0.861	Insoluble	2.27	27

# Oxygen

**Table** Physical properties of oxygen.

Molecular weight	32.00
Specific volume @ 21 °C, 1 atm	755.4 ml/g
Boiling point @ 1 atm	-183.0 °C
Triple point	-218.8 °C
Density (gas) @ 0 °C, 1 atm	1.4291 g/l
Density (liquid) @ bp	1.141 g/l
Critical temperature	1118.4 °C
Critical pressure	737 psia (50.14 atm)
Critical density	0.427 g/l
Latent heat of vaporization @ bp	50.94 cal/g
Specific heat (gas) @ 15 °C, 1 atm	
$C_p$	0.2200 cal/g °C
$C_v$	0.1554 cal/g °C
ratio $C_p/C_v$	1.42
Viscosity (gas) @ 25 °C, 1 atm	0.02064 centipoise
Solubility in water @ 0 °C, 1 atm	1 volume/21 volumes water



# Ozone

**Table** Physical properties of ozone.

Molecular weight	47.998
Boiling point @ 1 atm	-111.9 °C
Freezing point @ 1 atm	-192 °C
Density (gas) @ 0 °C, 1 atm	2.143 g/l
Density (liquid) @ -183 °C	1.571 g/l
Critical temperature	-12.1 °C
Critical pressure	802.6 psia (54.6 atm)
Viscosity (liquid) @ -183 °C	1.57 cP
Latent heat of vaporization @ bp	3410 cal/mole
Dielectric constant (liquid) @ -183 °C	4.79
Dipole moment	0.55D
Solubility in water @ 0 °C, 1 atm	0.494 volume/volume of water





# Paraffin Hydrocarbons

Paraffin hydrocarbons (alkanes) are non-cyclic saturated hydrocarbons in which each carbon atom has 4 bonds (either C-C or C-H), and each hydrogen atom is joined to one of the carbon atoms (so in a C-H bond). The alkanes range in complexity from the simplest case of methane (CH<sub>4</sub>), which is the predominant constituent of natural gas, to arbitrarily large molecules that occur in petroleum waxes.

Alkanes are not very reactive and have little biological activity and can be considered to be the skeletal structures for the more active/reactive functional groups. An alkyl group, generally abbreviated with the symbol R, is a functional group that, like an alkane, consists solely of single-bonded carbon and hydrogen atoms connected acyclically, for example, a methyl group (CH<sub>3</sub>-) or an ethyl group (C<sub>2</sub>H<sub>5</sub>-).

**Table 1** Names and formulas of the first ten paraffins (n-alkanes).

Name	Number of carbon atoms	Molecular formula	Structural formula	Number of isomers
Methane	1	CH <sub>4</sub>	CH <sub>4</sub>	1
Ethane	2	C <sub>2</sub> H <sub>6</sub>	CH <sub>3</sub> CH <sub>3</sub>	1
Propane	3	C <sub>3</sub> H <sub>8</sub>	CH <sub>3</sub> CH <sub>2</sub> CH <sub>3</sub>	1
Butane	4	C <sub>4</sub> H <sub>10</sub>	CH <sub>3</sub> CH <sub>2</sub> CH <sub>2</sub> CH <sub>3</sub>	2
Pentane	5	C <sub>5</sub> H <sub>12</sub>	CH <sub>3</sub> (CH <sub>2</sub> ) <sub>3</sub> CH <sub>3</sub>	3
Hexane	6	C <sub>6</sub> H <sub>14</sub>	CH <sub>3</sub> (CH <sub>2</sub> ) <sub>4</sub> CH <sub>3</sub>	5
Heptane	7	C <sub>7</sub> H <sub>16</sub>	CH <sub>3</sub> (CH <sub>2</sub> ) <sub>5</sub> CH <sub>3</sub>	9
Octane	8	C <sub>8</sub> H <sub>18</sub>	CH <sub>3</sub> (CH <sub>2</sub> ) <sub>6</sub> CH <sub>3</sub>	18
Nonane	9	C <sub>9</sub> H <sub>20</sub>	CH <sub>3</sub> (CH <sub>2</sub> ) <sub>7</sub> CH <sub>3</sub>	35
Decane	10	C <sub>10</sub> H <sub>22</sub>	CH <sub>3</sub> (CH <sub>2</sub> ) <sub>8</sub> CH <sub>3</sub>	75

**Table 2** Boiling Points of n-Paraffin Derivatives.

Carbon number	Boiling point, °C	Boiling point, °F
5	36	97
6	69	156
7	98	209
8	126	258
9	151	303
10	174	345
11	196	385
12	216	421
13	235	456
14	253	488
15	271	519
16	287	548
17	302	576
18	317	602
19	331	627
20	344	651
21	356	674
22	369	696
23	380	716
24	391	736
25	402	755
26	412	774
27	422	792
28	432	809
29	441	825
30	450	841
31	459	858
32	468	874
33	476	889
34	483	901
35	491	916
36	498	928
37	505	941
38	512	958
39	518	964
40	525	977
41	531	988
42	537	999
43	543	1009
44	548	1018

**Table 3** Melting Points of n-Paraffin Derivatives.

Number of carbon atoms	Melting point	
	°C	°F
1	-182	-296
2	-183	-297
3	-188	-306
4	-138	-216
5	-130	-202
6	-95	-139
7	-91	-132
8	-57	-71
9	-54	-65
10	-30	-22
11	-26	-15
12	-10	14
13	-5	23
14	6	43
15	10	50
16	18	64
17	22	72
18	28	82
19	32	90
20	36	97
30	66	151
40	82	180
50	92	198
60	99	210

# Particle Size Classification

**Table** General particle size classification.

<i>Sediment class</i>	<i>Diameter, mm</i>
Boulder	>256
Large cobble	256–128
Small cobble	128–64
Pebble	
Very large pebble	64–32
Large pebble	32–16
Medium pebble	16–8
Small pebble	8–4
Granule	4–2
Sand	
Very coarse sand	2–1
Coarse sand	1–1/2

<i>Sediment class</i>	<i>Diameter, mm</i>
Medium sand	1/2–1/4
Fine sand	1/4–1/8
Very fine sand	1/8–1/16
Silt	
Coarse silt	1/16–1/32
Medium silt	1/32–1/64
Fine silt	1/64–1/128
Very fine silt	1/128–1/256
Clay	
Coarse clay	1/256–1/512
Medium clay	1/512–1/1024
Fine clay	1/1024–1/12048
Very fine clay	1/2048–1/4096



# Permeability

Permeability (commonly symbolized as  $\kappa$ , or  $k$ ) is a measure of the ease with which fluid is able to flow through a porous medium (in the current context, a rock or unconsolidated material) to transmit fluids. It is of great importance in determining the flow characteristics of hydrocarbons in oil and gas reservoirs (Table). It is typically measured through calculation of Darcy's law.

Hydrocarbon-bearing formations are judged according to their permeability and porosity since these are the major factors that influence the producibility from the net pay zone. In general, for a rock to be considered as an exploitable hydrocarbon reservoir without stimulation, the permeability must be greater than approximately 100 mD. Formations having permeability greater than 250 mD are considered very good and those having a permeability less than 1 mD, typically found in chalk formations, are considered poor. This changes, however, with the nature of the viscosity of the fluid. Gas reservoirs with permeability lower than 100 mD are exploitable because of the lower viscosity of gas; oil will not flow as well through such a formation. Unconsolidated sands may have a permeability of over 5000 mD and very well consolidated sands have permeability of less than 100 mD, since cementation and permeability are inversely proportional. Seals or traps are those reservoir structures which prevent the further migration of the hydrocarbon, and these structures usually have very low permeability i.e., the matrix is not conducive to flow.

The factors affecting absolute permeability can be grouped into the following categories:

1. *Rock-related factors* are natural factors i.e., basic characteristics, structure, or indigenous properties of reservoir rocks, such as grain size and shape and clay cementing. For flat grains, horizontal permeability is greater than vertical permeability. Clay cementing reduces pore spaces and alters flow paths.

2. *Fluid phase-related factors* are characterized as artificial or laboratory factors in which the type of fluid medium used for permeability measurement as well as the chemical characteristics of the fluids affect permeability. Water causes clay swelling of certain clays, which in turn reduces permeability. Different clays have different cationic exchange capacities, which affect the permeability. The use of sea water is accompanied by salt precipitation, which results in formation damage. In addition, paraffin wax deposition from the use of degassed oil results in formation damage also succeeds in altering the internal geometry of the rock.
3. Thermodynamic-related factors are fluid-rock-interaction-induced laboratory artifacts which consist of temperature effects.
4. Mechanical factors: are laboratory artifacts related to the effect of mechanical stresses or confining pressures on absolute permeability. Pressure is a function of depth. Fracturing also changes permeability.

Permeability (commonly symbolized as  $\kappa$ , or  $k$ ) is a measure of the ease with which fluid is able to flow through a porous medium (in the current context, a rock or unconsolidated material) to transmit fluids. It is of great importance in determining the flow characteristics of hydrocarbons in oil and gas reservoirs. It is typically measured through calculation of Darcy's law. The intrinsic permeability of any porous material is:

$$\kappa_i = C \cdot d^2$$

$\kappa_i$  is the intrinsic permeability [L<sup>2</sup>],  $C$  is a dimensionless constant that is related to the configuration of the flow-paths,  $d$  is the average, or effective pore diameter [L]. A common unit for permeability is the Darcy (D), or more commonly the milliDarcy (mD). Typically, reservoir rock permeability

lies in the range of a few milliDarcys to several Darcys, but exceptions are not uncommon. Productive limestone matrix permeability may be as low as a fraction of a milliDarcy while fractures, vugs, and caverns may have extremely high permeability.

For a rock to be considered as an exploitable hydrocarbon reservoir without stimulation, its permeability must be greater than approximately 100 mD (depending on the nature of the hydrocarbon; gas reservoirs with lower permeability are still exploitable because of the lower viscosity of gas with respect to oil). Rocks with permeability

significantly lower than 100 mD can form efficient seals. Unconsolidated sand may have permeability in excess of 5000 mD.

Variation of permeability within a reservoir is common, with vertical permeability ( $k_v$ ) typically being lower than horizontal permeability ( $k_h$ ) due to stratification and layering that occurs during reservoir deposition. Vertical-to-horizontal permeability ratios ( $k_v/k_h$ ) typically lie in the range of 0.1 to 0.001. A situation in which horizontal permeability in one direction varies from that in another direction is known as permeability anisotropy.

**Table** Permeability of Different Systems.

Permeability	Pervious				Semi-Pervious				Impervious				
Unconsolidated Sand & Gravel	Well Sorted Gravel		Well Sorted Sand or Sand & Gravel		Very Fine Sand, Silt, Loess, Loam								
Unconsolidated Clay and Organic					Peat		Layered Clay		Fat / Unweathered Clay				
Consolidated Rocks	Highly Fractured Rocks				Reservoir Rocks			Fresh Sandstone	Limestone or Dolomite		Granite		
$\kappa$ (cm <sup>2</sup> )	0.001	0.0001	10 <sup>-5</sup>	10 <sup>-6</sup>	10 <sup>-7</sup>	10 <sup>-8</sup>	10 <sup>-9</sup>	10 <sup>-10</sup>	10 <sup>-11</sup>	10 <sup>-12</sup>	10 <sup>-13</sup>	10 <sup>-14</sup>	10 <sup>-15</sup>
$\kappa$ (millidarcy)	10 <sup>+8</sup>	10 <sup>+7</sup>	10 <sup>+6</sup>	10 <sup>+5</sup>	10,000	1,000	100	10	1	0.1	0.01	0.001	0.0001

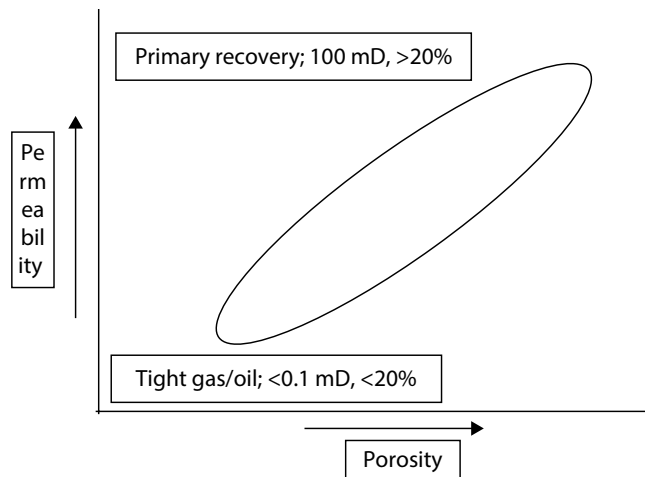

**Figure** General trends in the relationship between porosity and permeability.

# Petrochemicals

A *petrochemical* is any chemical (as distinct from fuels and petroleum products) manufactured from petroleum (and natural gas) and used for a variety of commercial purposes. The definition, however, has been broadened to include the whole range of aliphatic, aromatic, and naphthenic organic chemicals, as well as carbon black and such inorganic materials as sulfur and ammonia. Petroleum and natural gas are made up of hydrocarbon molecules, which are comprised of one or more carbon atoms, to which hydrogen atoms are attached. Currently, through a variety of intermediates (Table 1) oil and gas are the main sources of the raw materials (Table 2) because they are the least expensive, most readily available, and can be processed most easily into the primary

petrochemicals. Primary petrochemicals include: olefins (ethylene, propylene and butadiene) aromatics (benzene, toluene, and the isomers of xylene); and methanol. Thus, petrochemical feedstocks can be classified into three general groups: olefins, aromatics, and methanol; a fourth group includes inorganic compounds and synthesis gas (mixtures of carbon monoxide and hydrogen). In many instances, a specific chemical included among the petrochemicals may also be obtained from other sources, such as coal, coke, or vegetable products. For example, materials such as benzene and naphthalene can be made from either petroleum or coal, while ethyl alcohol may be of petrochemical or vegetable origin.

**Table 1** Hydrocarbon intermediates used in the petrochemical industry.

Starting feedstock	Process	Product
Petroleum	Distillation	Light ends methane ethane propane butane
	Catalytic cracking	ethylene propylene butylenes higher olefins
	coking	ethylene propylene butylenes higher olefins
Natural gas	refining	methane ethane propane butane

**Table 2** Sources of Petrochemical Intermediates.

Intermediate	Source
Methane	Natural gas
Ethane	Natural gas
Ethylene	Cracking processes
Propane	Natural gas, catalytic reforming, cracking processes
Propylene	Cracking processes
Butane	Natural gas, reforming and cracking processes
Butene(s)	Cracking processes
Cyclohexane	Distillation
Benzene	Catalytic reforming
Toluene	Catalytic reforming
Xylene(s)	Catalytic reforming
Ethylbenzene	Catalytic reforming
Alkylbenzenes	Alkylation
>C <sub>9</sub>	Polymerization





## Petroleum Products – Heat Content

Product	MMBtu/bbl
Crude oil	5.8
Natural gas plant liquids	3.735
Asphalt	6.636
Aviation gasoline	5.048
Butane	4.326
Butane-propane (60/40) mixture	4.13
Distillate fuel oil	5.825
Ethane	3.082
Ethane-propane (70/30) mixture	3.308
Isobutane	3.974
Jet fuel, kerosene-type	5.67
Jet fuel, naphtha-type	5.355
Kerosene	5.67

Product	MMBtu/bbl
Lubricants	6.065
Motor gasoline, oxygenated or reformulated	5.15
Motor gasoline	3.539
Naphtha <401 °F	5.248
Natural gasoline	4.62
Pentanes plus	4.62
Petroleum coke	6.024
Plant condensate	5.418
Propane	3.836
Residual fuel oil	6.287
Road oil	6.636
Still gas	6.000
Waxes	5.537



# Petroleum Products

*Petroleum products*, in contrast to *petrochemicals*, are those bulk fractions that are derived from petroleum and have commercial value as a bulk product. In the strictest sense, petrochemicals are also petroleum products but they are individual chemicals that are used as the basic building blocks of the chemical.

Liquefied Petroleum Gas (LPG) is predominantly propane with iso-butane and n-butane and the tanks do not have to be high pressure, and the fuel is stored as a liquid. The boiling range is narrow because of the low number of constituents. On the other hand, gasoline contains over 500 hydrocarbons that may have between 3 to 12 carbons, and gasoline used to have a boiling range from 30 to 220 °C at atmospheric pressure. The boiling range is narrowing as the initial boiling point is increasing, and the final boiling point is decreasing; both changes are for environmental reasons.

*Naphtha* is the general term that is applied to refined, partly refined or unrefined low-boiling liquid petroleum products and has a boiling range between room temperature 200°C (390°F). Naphtha is prepared by any one of several methods including (1) fractionation of distillates or even crude petroleum, (2) fluid catalytic cracking, (3) solvent extraction, (4) hydrogenation of distillates, (5) polymerization of unsaturated (olefin) compounds, and (6) alkylation processes. Naphtha may also be a combination of product streams from more than one of these processes.

It is sometimes incorrectly referred to as gasoline, which is a hangover from the times when gasoline was produced directly from petroleum. In the modern refinery, gasoline (for sales) is actually a blend of several refinery streams.

Kerosene is the fraction that typically distills between 170 to 270 °C (narrow cut kerosene, or Jet A1) or 100 to 250 °C (wide cut kerosene, or JP-4). Kerosene contains approximately 20% v/v aromatics; however, the aromatic content will be reduced for high-quality lighting kerosene, as the aromatics reduce the smoke point. The major use for kerosene is as aviation turbine (jet) fuel. Special properties are required for that application, including high flash point for safe refueling (38 °C for Jet A1), low freezing point for high altitude flying (−47 °C for Jet A1), and good water separation characteristics.

Diesel fuel is used in compression ignition engines, and is the fraction that typically distills between 250 to 380 °C. Diesel engines use the cetane (n-hexadecane) rating to assess ignition delay. Normal alkanes have a high cetane rating, ( $nC_{16} = 100$ ) whereas aromatics (alpha methylnaphthalene = 0) and iso-alkanes (2,2,4,4,6,8,8-hexamethylnonane = 15) have low ratings, which represent long ignition delays. Because of the molecular size of the hydrocarbons, the low temperature flow properties control the composition of diesel, and additives are used to prevent filter blocking in cooler temperatures; there are usually summer and winter grades.

**Table 1** General properties of liquid products from petroleum.

	Molecular weight	Specific gravity	Boiling point °F	Ignition temperature °F	Flash point °F	Flammability limits in air % v/v
Benzene	78.1	0.879	176.2	1040	12	1.35–6.65
Diesel fuel	170–198	0.875			100–130	
Fuel oil No. 1		0.875	304–574	410	100–162	0.7–5.0
Fuel oil No. 2		0.920		494	126–204	
Fuel oil No. 4	198.0	0.959		505	142–240	
Fuel oil No. 5		0.960			156–336	
Fuel oil No. 6		0.960			150	
Gasoline	113.0	0.720	100–400	536	–45	1.4–7.6
n-Hexane	86.2	0.659	155.7	437	–7	1.25–7.0
n-Heptane	100.2	0.668	419.0	419	25	1.00–6.00
Kerosene	154.0	0.800	304–574	410	100–162	0.7–5.0
Neohexane	86.2	0.649	121.5	797	–54	1.19–7.58
Neopentane	72.1		49.1	841	Gas	1.38–7.11
n-Octane	114.2	0.707	258.3	428	56	0.95–3.2
iso-Octane	114.2	0.702	243.9	837	10	0.79–5.94
n-Pentane	72.1	0.626	97.0	500	–40	1.40–7.80
iso-Pentane	72.1	0.621	82.2	788	–60	1.31–9.16
n-Pentene	70.1	0.641	86.0	569	–	1.65–7.70
Toluene	92.1	0.867	321.1	992	40	1.27–6.75
Xylene	106.2	0.861	281.1	867	63	1.00–6.00

**Table 2** Heat content of fuel oil.

Grade	Heating value, Btu/gal	Comments
Fuel Oil No. 1	132,900–137,000	Small Space Heaters
Fuel Oil No. 2	137,000–141,800	Residential Heating
Fuel Oil No. 4	143,100–148,100	Industrial Burners
Fuel Oil No. 5 (Light)	146,800–150,000	Preheating in General Required
Fuel Oil No. 5 (Heavy)	149,400–152,000	Heating Required
Fuel Oil No. 6	151,300–155,900	Bunker C

**Table 3** Relationship of Heat Content to API Gravity.

°API at 60 °F	Density, lb/gal*	High heat value (HHV) at constant volume $Q_v$ , Btu		Low heat value (LHV) at constant pressure $Q_p$ , Btu	
		Per lb	Per gal	Per lb	Per gal
10	8.337	18,540	154,600	17,540	146,200
20	7.787	19,020	148,100	17,930	139,600
30	7.305	19,420	141,800	18,250	133,300
40	6.879	19,750	135,800	18,510	127,300
50	6.5	20,020	130,100	18,720	121,700
60	6.16	20,260	124,800	18,900	116,400
70	5.855	20,460	119,800	19,020	112,500
80	5.578	20,630	115,100	19,180	107,000

\*Btu/lb  $\times$  2.328 = kJ/kg; Btu/gal  $\times$  279 = kJ/M<sup>3</sup>

**Table 4** Latent Heat of Vaporization of Petroleum Products.

Product	Gravity, °API	Average boiling temp, °F	Heat of vaporization	
			Btu/lb	Btu/gal
Gasoline	60	280	116	715
Naphtha	50	340	103	670
Kerosene	40	440	86	595
Fuel oil	30	580	67	490

**Table 5** Relationship of refractive index to dielectric constant.

Material	Refractive index n	n <sup>2</sup>	Dielectric constant
Benzene	1.501	2.25	2.283
Cyclohexane	1.427	2.04	2.055
n-Hexane	1.375	1.89	1.89
n-Heptane	1.388	1.93	1.933
Kerosene	1.449	2.1	2.135
Paraffin oil	1.481	2.19	2.195
Vaseline	1.48	2.19	2.078



# Phase Behavior

Phase behavior is the tendency of a fluid system to form phases as a result of changing temperature, pressure, or the bulk composition of the fluids or of individual fluid phases. The phase behavior of natural gas phase is best represented by a plot of pressure versus temperature that determines whether the natural gas stream at a given pressure and temperature consists of a single gas phase or two phases: gas and liquid. The phase behavior for natural gas with a given composition is typically displayed on a phase diagram (Figure).

The left-hand side of the curve is the bubble point line and divides the single-phase liquid region from the two-phase gas-liquid region. The right-hand side of the curve is the dew point line and divides the two-phase gas-liquid region and the single-phase gas region. The bubble point and dew point lines intersect at the critical point, where the distinction between gas and liquid properties disappears. Dew point temperatures are possible at a given pressure, and two dew point pressures are possible at a given temperature. This phenomenon is known as retrograde condensation.

The maximum pressure at which liquids can form is called the *cricondenbar*, and the maximum temperature at which liquids can form is called the *cricondentherm*. The natural gas phase behavior is a function of the composition

of the gas mixture and is strongly influenced by the concentration of the heavier hydrocarbons, especially hexane and higher boiling hydrocarbons. The presence of higher molecular weight hydrocarbons will increase the phase envelope and failure to include them in a phase calculation will cause errors in the prediction of the phase envelope.

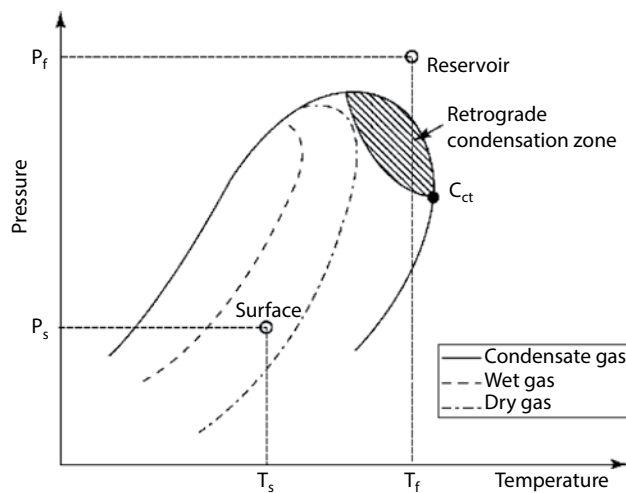

**Figure** Phase diagram of different types of natural gas.





# Polychlorobiphenyls

Polychlorobiphenyls (PCBs) are a class of chemical compounds in which as few as two and as many as ten (the maximum) chlorine atoms are attached to the biphenyl molecule. Monochlorinated biphenyls (i.e., one chlorine atom attached to the biphenyl molecule) are often included when describing PCBs. The general chemical structure of chlorinated biphenyls:

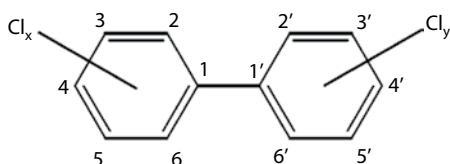

The benzene rings can rotate around the bond connecting them; the two extreme configurations are planar (the two benzene rings in the same plane) and the non-planar in which the benzene rings are at a 90° angle to each other. The degree of planarity is largely determined by the number of substitutions in the ortho positions. The replacement of hydrogen atoms in the ortho positions with larger chlorine atoms forces the benzene rings to rotate out of the planar configuration. The

benzene rings of non-ortho substituted polychlorobiphenyls, as well as mono-ortho substituted polychlorobiphenyls, may assume a planar configuration and are referred to as planar or coplanar congeners; the benzene rings of other congeners cannot assume a planar or coplanar configuration and are referred to as non-planar congeners.

The trade names of some commercial polychlorobiphenyl mixtures manufactured in other countries are Clophen (Germany), Fenclor (Italy), Kanechlor (Japan), and Phenoclor (France). The composition of commercial Clophen A-60 and Phenoclor DP-6 is similar to Aroclor 1260; that of Kanechlor 500 is similar to Aroclor 1254. Fenclor contains 100% decachlorobiphenyl (De Voogt and Brinkman 1989). The chemical identity of the Aroclors is summarized in Table 1. The identity of the 209 PCB congeners is shown in Tables 2 and 3. The congeners are arranged in ascending numerical order using a numbering system developed by Ballschmiter and Zell (1980) that follow the IUPAC rules of substituent characterization in biphenyls. The resulting PCB numbers, also referred to as congener, IUPAC, or BZ numbers, are widely used for identifying individual congeners.

**Table 1** Chemical identity of selected polychlorinated biphenyl derivatives (Aroclor compounds).

Characteristic	Aroclor 1016	Aroclor 1221	Aroclor 1232	Aroclor 1242	Aroclor 1248
Synonym(s)	PCB-1016; Polychlorinated biphenyl mixture with 41.5% chlorine	PCB-1221; Polychlorinated biphenyl mixture with 21% chlorine	PCB-1232; Polychlorinated biphenyl mixture with 32% chlorine	PCB-1242; Polychlorinated biphenyl mixture with 41.5% chlorine	PCB-1248; Polychlorinated biphenyl mixture with 48% chlorine
Registered trade name(s)	Aroclor <sup>c</sup>	Aroclor	Aroclor	Aroclor	Aroclor

Characteristic	Aroclor 1254	Aroclor 1260	Aroclor 1262	Aroclor 1268
Synonym(s)	PCB-1254; Polychlorinated biphenyl mixture with 54% chlorine	PCB-1260; Polychlorinated biphenyl mixture with 60% chlorine	PCB-1262; Polychlorinated biphenyl mixture with 61.5–62.5% chlorine	PCB-1268; Polychlorinated biphenyl mixture with 68% chlorine
Registered trade name(s)	Aroclor	Aroclor	Aroclor	Aroclor

**Table 2** Physical and chemical properties of Aroclor derivatives.

Property	Aroclor 1016	Aroclor 1221	Aroclor 1232	Aroclor 1242
Molecular weight <sup>b</sup>	257.9 <sup>c</sup>	200.7 <sup>c</sup>	232.2 <sup>c</sup>	266.5 <sup>c</sup>
Color	Clear	Clear	Clear	Clear
Physical state	Oil	Oil	Oil	Oil
Melting point, • C	No data	1 <sup>d</sup>	No data	No data
Boiling point, • C	325–356	275–320	290–325	325–366
Density, g/cm <sup>3</sup> at 25 • C	1.37	1.18	1.26	1.38
Odor	No data	No data	No data	Mild hydrocarbon <sup>d</sup>
Odor threshold:				
Water	No data	No data	No data	No data
Air	No data	No data	No data	No data
Solubility:				
Water, mg/L	0.42 (25 • C) <sup>e</sup>	0.59 (24 • C) <sup>f</sup>	0.45 (25 • C)	0.24 <sup>g</sup> ; 0.34 (25 • C) <sup>e</sup> 0.10 (24 • C) <sup>f</sup>
Organic solvent(s)	Very soluble <sup>g</sup>	Very soluble <sup>g</sup>	Very soluble <sup>g</sup>	Very soluble <sup>g</sup>
Partition coefficients:				
Log K <sub>ow</sub> <sup>h</sup>	5.6	4.7	5.1	5.6
Log K <sub>oc</sub>	No data	No data	No data	No data
Vapor pressure, mm Hg at 25 • C	4 × 10 <sup>-4c</sup>	6.7 × 10 <sup>-3c</sup>	4.06 × 10 <sup>-3c</sup>	4.06 × 10 <sup>-4c</sup>
Henry's law constant, atm-m <sup>3</sup> /mol at 25 • C <sup>i</sup>	2.9 × 10 <sup>-4</sup>	3.5 × 10 <sup>-3</sup>	No data	5.2 × 10 <sup>-4</sup>
Autoignition temperature	No data	No data	No data	No data
Flashpoint, • C (Cleveland open cup)	170	141–150	152–154	176–180
Flammability limits, • C	None to boiling point	176	328	None to boiling point
Conversion factors Air (25 • C) <sup>i</sup>	1 mg/m <sup>3</sup> =0.095 ppm	1 mg/m <sup>3</sup> = 0.12 ppm	1 mg/m <sup>3</sup> = 0.105 ppm	1 mg/m <sup>3</sup> = 0.092 ppm
Explosive limits	No data	No data	No data	No data

**Table 3** Physical and chemical properties of Aroclor derivatives (contd.).

Property	Aroclor 1254	Aroclor 1260	Aroclor 1262	Aroclor 1268
Molecular weight <sup>b</sup>	328 <sup>c</sup>	357.7 <sup>c</sup>	389	453
Color	Light yellow	Light yellow	No data	Clear <sup>k</sup>
Physical state	Viscous liquid	Sticky resin	No data	Viscous liquid <sup>k</sup>
Melting point	No data	No data	No data	No data
Boiling point, • C	365–390	385–420	390–425	435–450
Density, g/cm <sup>3</sup> at 25 • C	1.54	1.62	1.64	1.81
Odor	Mild hydrocarbon <sup>b</sup>	No data	No data	No data
Odor threshold:				
Water	No data	No data	No data	No data
Air	No data	No data	No data	No data
Solubility:				
Water, mg/L	0.012 <sup>c</sup> ; 0.057 (24 • C)	0.0027 <sup>c</sup> ; 0.08 (24 • C) <sup>f</sup>	0.052 (24 • C) <sup>f</sup>	0.300 (24 • C) <sup>f</sup>
Organic solvent(s)	Very soluble <sup>g</sup>	Very soluble <sup>g</sup>	No data	Soluble

(Continued)

Table 3 Cont.

Property	Aroclor 1254	Aroclor 1260	Aroclor 1262	Aroclor 1268
Partition coefficients:				
Log $K_{ow}$	6.5	6.8	No data	No data
Log $K_{oc}$	No data	No data	No data	No data
Vapor pressure, mm Hg at 25 • C	$7.71 \times 10^{-5c}$	$4.05 \times 10^{-5c}$	No data	No data
Henry's law constant, atm-m <sup>3</sup> /mol at 25 • C <sup>i</sup>	$2.0 \times 10^{-3}$	$4.6 \times 10^{-3}$	No data	No data
Autoignition temperature	No data	No data	No data	No data
Flashpoint, • C (Cleveland open cup)	No data	No data	195 • C	195 • C
Flammability limits, • C	None to boiling point	None to boiling point	None to boiling point	None to boiling point
Conversion factors Air (25 • C) <sup>i</sup>	1 mg/m <sup>3</sup> = 0.075 ppm	1 mg/m <sup>3</sup> = 0.065 ppm	1 mg/m <sup>3</sup> = 0.061 ppm	1 mg/m <sup>3</sup> = 0.052 ppm
Explosive limits	No data	No data	No data	No data



# Porosity

Porosity is a measure of the spaces between grains of sediment in sedimentary rock. A porous system is a system that allows storage (porosity) and enables transmission (permeability). The porosity of the reservoir rock is a measure of the pore space available for the storage of fluids in rock. Thus:

$$\text{Porosity, } \phi = Vp/Vb = (Vb - Vm)/Vp$$

The porosity is expressed as a fraction of per cent,  $Vb = Vp + Vm$ ,  $Vb$  is the bulk volume of reservoir rock (liters<sup>3</sup>),  $Vp$  is the pore volume, (liters<sup>3</sup>), and  $Vm$  is the matrix volume, (liters<sup>3</sup>).

The *total porosity* is the amount of void space in a formation rock, usually expressed as a percentage of the voids and/or spaces per bulk volume. Total porosity is the total void space in the rock whether or not it contributes to fluid storage, and thus can include isolated pores and the spaces occupied by clay bound water. Porosity is expressed as a fraction between 0 and 1 or as a percentage between 0 and 100%.

$$\text{Total porosity} = \text{Effective porosity} \\ + \text{Ineffective porosity}$$

The total porosity is often referred to as the *absolute porosity*. Thus, the *absolute porosity* is the ratio of the total pore space of the rock to that of the bulk volume. whether or not that space is accessible to fluid penetration. A sediment may have considerable absolute porosity and yet have no conductivity to fluid for lack of pore.

$$\Phi_a = \text{total pore volume/bulk volume}$$

or

$$\Phi_a = (\text{bulk volume} - \text{grain volume})/\text{total bulk volume}$$

or

$$\Phi_a = \frac{\text{vol of interconnected pores} + \text{vol of dead} \\ \text{end pores} + \text{vol of isolated pores}}{\text{total or bulk volume}}$$

*Effective porosity* refers to the amount of interconnected pore spaces, i.e., the space available to fluid penetration, in relation to the bulk volume. It includes cul-de-sac or dead-end porosity. Therefore, *ineffective porosity* is the amount of pore spaces that are not interconnected i.e., the isolated pore spaces, in relation to the bulk volume.

Effective porosity is given by:

$$\Phi_e = \text{interconnected pore volume/bulk volume}$$

or

$$\Phi_e = (\text{volume of interconnected pores} + \text{cul-de-sacs})/ \\ \text{total or bulk volume}$$

Ineffective porosity is given by:

$$\Phi_{\text{ineff}} = (\text{volume of completely disconnected pores})/ \\ \text{total volume or bulk volume}$$

Other definitions include (1) primary porosity or original porosity, which developed at time of deposition, and (2) the secondary porosity, which developed as a result of geologic processes occurring after deposition.

Porosity is independent of grain size when the sorting is the same. Porosity is dependent on packing, which is

dependent on depositional and diagenetic history. Packing is also dependent on grain size, sorting, orientation, and the degree of cementation. For a system of particles of the same grain size, the more compact the packing arrangement, the lower the porosity. Compaction decreases porosity – compaction creates a certain mechanical arrangement of grains and a new pore system pattern because of sediment compaction, which is marked by a reduction in pore volume. Finally, cementation decreases porosity. Cementation involves the deposition of materials in the pore space eventually causing a decrease in the pore volume. Therefore, more consolidated formations have lower porosity.

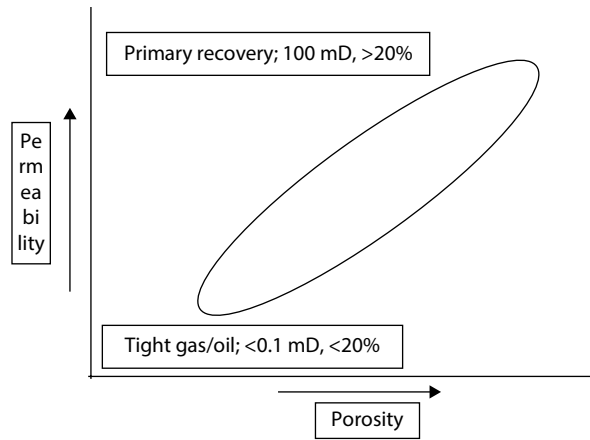

**Figure** General trends in the relationship between porosity and permeability.

# Prefixes

Submultiple	Prefix	Symbol	Multiple	Prefix	Symbol
$10^{-1}$	deci	d	10	deka	da
$10^{-2}$	centi	c	$10^2$	hecto	h
$10^{-3}$	milli	m	$10^3$	kilo	k
$10^{-6}$	micro	$\mu$	$10^6$	mega	M
$10^{-9}$	nano	n	$10^9$	giga	G
$10^{-12}$	pico	p	$10^{12}$	tera	T
$10^{-15}$	femto	f	$10^{15}$	peta	P
$10^{-18}$	atto	a	$10^{18}$	exa	E
$10^{-21}$	zepto	z	$10^{21}$	zetta	Z
$10^{-24}$	yocto	y	$10^{24}$	yotta	Y





# Pressure Conversion

psi	Inches H <sub>2</sub> O at 4 °C	Inches Hg at 0 °C	mmH <sub>2</sub> O at 4 °C	mmHg at 0 °C	atm	Pascals (N · m <sup>-2</sup> )
0.01	0.2768	0.0204	7.031	0.517	0.0007	68.95
0.02	0.5536	0.0407	14.06	1.034	0.0014	137.90
0.03	0.8304	0.0611	21.09	1.551	0.0020	206.8
0.04	1.107	0.0814	28.12	2.068	0.0027	275.8
0.05	1.384	0.1018	35.15	2.586	0.0034	344.7
0.06	1.661	0.1222	42.18	3.103	0.0041	413.7
0.07	1.938	0.1425	49.22	3.620	0.0048	482.6
0.08	2.214	0.1629	56.25	4.137	0.0054	551.6
0.09	2.491	0.1832	63.28	4.654	0.0061	620.5
0.10	2.768	0.2036	70.31	5.171	0.0068	689.5
0.20	5.536	0.4072	140.6	10.34	0.0136	1 379.9
0.30	8.304	0.6108	210.9	15.51	0.0204	2 068.5
0.40	11.07	0.8144	281.2	20.68	0.0272	2 758
0.50	13.84	1.018	351.5	25.86	0.0340	3 447
0.60	16.61	1.222	421.8	31.03	0.0408	4 137
0.70	19.38	1.425	492.2	36.20	0.0476	4 826
0.80	22.14	1.629	562.5	41.37	0.0544	5 516
0.90	24.91	1.832	632.8	46.54	0.0612	6 205
1.00	27.68	2.036	703.1	51.71	0.0689	6 895
2.00	55.36	4.072	1 072	103.4	0.1361	13 790
3.00	83.04	6.108	2 109	155.1	0.2041	20 684
4.00	110.7	8.144	2 812	206.8	0.2722	27 579
5.00	138.4	10.18	3 515	258.6	0.3402	34 474
6.00	166.1	12.22	4 218	310.3	0.4083	41 369
7.00	193.8	14.25	4 922	362.0	0.4763	48 263
8.00	221.4	16.29	5 625	413.7	0.5444	55 158
9.00	249.1	18.32	6 328	465.4	0.6124	62 053
10.0	276.8	20.36	7 031	517.1	0.6805	68 948
14.7	406.9	29.93	10 332	760.0	1.000	101 325

(Continued)

psi	Inches H <sub>2</sub> O at 4 °C	Inches Hg at 0 °C	mmH <sub>2</sub> O at 4 °C	mmHg at 0 °C	atm	Pascals (N · m <sup>-2</sup> )
15.0	415.2	30.54	10 550	775.7	1.021	103 421
20.0	553.6	40.72	14 060	1 034	1.361	137 895
25.0	692.0	50.90	17 580	1 293	1.701	172 369
30.0	830.4	61.08	21 090	1 551	2.041	206 843
40.0	1 107	81.44	28 120	2 068	2.722	275 790
50.0	1 384	101.8	35 150	2 586	3.402	344 738
60.0	1 661	122.2	42 180	3 103	4.083	413 685
70.0	1 938	142.5	49 220	3 620	4.763	482 633
80.0	2 214	162.9	56 250	4 137	5.444	551 581
90.0	2 491	183.2	63 280	4 654	6.124	620 528
100.0	2 768	203.6	70 307	5 171	6.805	689 476
150.0	4 152	305.4		7 757	10.21	1 034 214
200.0	5 536	407.2		10 343	13.61	1 378 951
250.0	6 920	509.0			17.01	1 723 689
300.0	8 304	610.8			20.41	2 068 427
400.0					27.22	2 757 903
500.0					34.02	3 447 379

1 bar = 10<sup>5</sup> pascal.

# Principal Component Analysis

Principal component analysis (PCA) is a method for determining the number of significant components for a linear system and allows the representation of  $m$  experimental chromatograms in a  $k$ -dimensional vector space ( $k \leq m$ ), where each of the  $m$  chromatograms is a linear combination of the  $k$  underlying significant components. An experimental chromatogram  $S_i$  can be regenerated from the  $k$  underlying components (identified as the eigenvectors  $V_1, V_2, V_3, \dots, V_k$ ) as  $S_i'$ ,

$$S_i = S_i' + R \quad (1)$$

$R$  is a residual vector composed of all contributions from the factors found not to be significant and,

$$S_i' = \xi_{1,i} V_1 + \xi_{2,i} V_2 + \xi_{3,i} V_3 + \dots + \xi_{k,i} V_k \quad (2)$$

where  $\xi_{1,i}, \xi_{2,i}, \xi_{3,i}, \dots, \xi_{k,i}$  are the combination coefficients unique to  $S_i$  for the eigenvectors  $V_1, V_2, V_3, \dots, V_k$ , respectively. The combination coefficients can be used to represent the chromatograms in the  $k$ -dimension vector space for pattern recognition.



# Process System

A process system, in the current context, is a collection of equipment that affects the required separation of crude oil and natural gas constituents or treatment through an integrated system of unit processes. For example, by means of a properly designed processing system, crude oil desalting is accomplished by intimate mixing of the crude oil with dilution water.

The necessary steps in the design of a process system are to determine the size and the type of equipment needed to carry out the physical changes, using the unit operations principle underlying this process, and to make sure that bottlenecks do not become a part of the system.



# Product Blending

The modern petroleum refinery consists of a very complex mix of high technology processes which efficiently convert the wide array of crude oils into the hundreds of specification products we use daily. Each refinery has its own unique processing configuration as a result of the logistics and associated economics related to its specific crude oils and products markets. The refiner must continuously optimize the mix of product volumes and this is accomplished through executing decisions regarding parameters as varied as crude oil feedstock selection, adjustments in product cut-points, and reactor severities in individual processes. Additional options include changing the dispositions of intermediate product streams to alternative processing units, or alternative finished product blends.

In fact, many refinery products are typically the result of blending several component streams or blending stocks. In most cases, product blending is accomplished by controlling the volumes of blend stocks from individual component storage tanks that are mixed in the finished product storage tank. Samples of the finished blend are then analyzed by laboratory testing for all product specifications prior to shipping. Alternatively, *in-line blending* refers to pipeline shipments in which the finished product is actually blended directly into the product pipeline (as opposed to a standing product storage tank).

The most commonly recognized blending operations occur in the gasoline production section of the refinery. The various gasoline streams are so that specifications (dependent upon geographic location, environmental regulations and weather patterns) can be met.

*Gasoline blending* involves combining of the components that make up motor gasoline. The components include the various hydrocarbon streams produced by distillation, cracking, reforming, and polymerization, tetraethyl lead, and identifying color dye, as well as other special-purpose

components, such as solvent oil and anti-icing compounds. The physical process of blending the components is simple, but determination of how much of each component to include in a blend is much more difficult. The physical operation is carried out by simultaneously pumping all the components of a gasoline blend into a pipeline that leads to the gasoline storage, but the pumps must be set to deliver automatically the proper proportion of each component. Baffles in the pipeline are often used to mix the components as they travel to the storage tank.

Selection of the components and their proportions in a blend is the most complex problem in a refinery. Many different hydrocarbon streams may need to be blended to produce quality gasoline. Each property of each stream is a variable, and the effect on the product gasoline is considerable. For example, the low octane number of straight-run naphtha limits its use as a gasoline component, although its other properties may make it desirable. The problem is further complicated by changes in the properties of the component streams due to processing changes. For example, an increase in cracking temperature produces a smaller volume of higher octane cracked naphtha, but before this cracked naphtha can be included in a blend, adjustments must be made in the proportions of the other hydrocarbon components. Similarly, the introduction of new processes and changes in the specifications of the finished gasoline dictate reevaluation of the components that make up the gasoline.

Gasoline blending is not the only blending operation, and other product blending operations are also in operation in a refinery. The applicable specifications vary by product but typically include properties pertinent to the behavior of the product in use. Many product specifications do not blend linearly by component volumes. In these circumstances, the finished blend properties are predicted using experience-based algorithms for the applicable blending components.





# Production Engineering Units

**Table** Typical units for crude oil and natural gas production engineering calculations.

Variable	Oilfield units	SI	Conversion (Multiply oilfield unit)
Area	acre	m <sup>2</sup>	$4.04 \times 10^3$
Compressibility	psi <sup>-1</sup>	Pa <sup>-1</sup>	$1.45 \times 10^{-4}$
Length	ft	m	$3.05 \times 10^{-1}$
Permeability	md	m <sup>2</sup>	$9.9 \times 10^{-16}$
Pressure	psi	Pa	$6.9 \times 10^3$
Rate (oil)	stb/d	m <sup>3</sup> /s	$1.84 \times 10^{-6}$
Rate (gas)	Mscf/d	m <sup>3</sup> /s	$3.28 \times 10^{-4}$
Viscosity	cp	Pa-s	$1 \times 10^{-3}$



# Productivity Index

The *productivity index* is a measure of the ability of a well to produce crude oil. The index is the ratio of the total liquid flow rate to the pressure drawdown. For a water-free oil, the productivity index ( $J$ ) is given by:

$$J = Q_o / (p_r - p_{wf}) = Q_o / \Delta p$$

In this equation,  $Q_o$  is the oil flow, STB/day,  $p_r$  is the volumetric average drainage area pressure (static pressure),  $p_{wf}$  is bottom-hole flowing pressure, and  $\Delta p$  is the drawdown (psi).

The productivity index is generally measured during a production test on the well. The well is shut-in until the static reservoir pressure is reached. The well is then allowed

to produce at a constant flow rate of  $Q$  and a stabilized bottom-hole flow pressure of  $p_{wf}$ . Since a stabilized pressure at surface does not necessarily indicate a stabilized  $p_{wf}$ , the bottom-hole flowing pressure should be recorded continuously from the time the well is to flow.

The productivity index for a gas well can be written in a manner analogous to the productivity index for an oil well. Thus:

$$(Q_g)_{\max} = J\psi_r$$

$Q_g$  is the gas flow rate,  $J$  is the productivity index, and  $\psi_r$  is the average reservoir real gas pseudo-pressure,  $\text{psi}^2/\text{cp}$ .



# Proppants

A proppant is a solid material, typically sand, treated sand, or a manufactured ceramic material that is designed to prevent and keep an induced hydraulic fracture open during and after a fracturing treatment so that the fracture does not collapse and close. Proppants typically comprise sand or manufactured ceramics such as bauxite (Table). Proppants can be resin-coated to improve packing, which helps the proppant stay in place and not flow back to the wellbore. Resin coatings also help provide better distribution of stress over the proppant pack.

Proppants are specified in grain diameter sizes of less than 1/16th of an inch. Some common mesh sizes are 16/20, 20/40, 30/50, 40/70, and 100. Treatments may use one size or a multitude of sizes during pumping. The smaller sizes are intended to reach closer to the fracture tip. A propped hydraulic fracture has a significantly greater fluid (hydraulic) conductivity than the surrounding lower permeability rock matrix. Challenges to stimulation treatments involve proper placement of proppant,

prevention of crushing or embedment, plugging at restrictions, and potential flowback of proppant to the wellbore. In the process, the proppant is added to a fracturing fluid which may vary in composition depending on the type of fracturing used and can be water-based, foam-based, or gel-based, slickwater-based, or any of a number of alternate fluids.

**Table** Proppant type definition.

Sand	Includes all raw sand types.
Resin-coated sand	Includes only resin-coated proppants for which the substrate is sand; does not include any double-counting with the "Sand category" described above.
Ceramic	Any proppant for which the substrate is a ceramic or otherwise manufactured proppant; resin-coated ceramic proppant is included in this category.



# PVT Properties

The specific correlations that should be used for a specific crude oil or reservoir may vary.

## Specific Gravity and Molecular Weight

$$\gamma_o = \frac{141.5}{\gamma_{API} + 131.5}$$

$$M_o = \left( \frac{K_w \gamma_o^{0.84573}}{4.5579} \right)^{6.58848}$$

## Isothermal Compressibility

$$X = R_s^{0.1982} T^{0.6685} \gamma_g^{-0.21435} \gamma_{API}^{1.0116} p^{-0.1616}$$

## Undersaturated Oil Formation Volume Factor

$$B_o = B_{ob} e^{[c_o(p_b - p)]} \quad (10)$$

## Oil density

$$\rho_o = \frac{62.42796 \gamma_o + 0.0136 \gamma_g R_s}{B_o}$$

## Dead Oil Viscosity

$$\mu_{od} = \left( \frac{3.141 \times 10^{10}}{T^{3.444}} \right) \log(\gamma_{API})^{[10.313 \log(T) - 36.447]}$$

## Undersaturated oil viscosity

$$\mu_o = \mu_{ob} \left( \frac{p}{p_b} \right)^{\left[ 2.6 p^{1.187} 10^{(-3.9 \times 10^{-5} p - 5)} \right]}$$

## Gas/Oil Interfacial Tension

$$\sigma_{od} = (1.17013 - 1.694 \times 10^{-3} T) (38.085 - 0.259 \gamma_{API})$$

## Water/Oil Interfacial Tension

$$T_{co} = 24.2787 K_w^{1.76544} \gamma_o^{2.12504}$$

Calculate the pseudocritical temperature of the gas:

$$T_{cg} = 169.2 + 349.5 \gamma_{ghc} - 74.0 \gamma_{ghc}^2$$

Calculate the pseudocritical temperature of the live gas/oil mixture.

$$T_{cm} = x_o T_{co} + x_g T_{cg}$$

Convert oil density units from lbm/ft<sup>3</sup> to g/cm<sup>3</sup>

$$\rho_h = \frac{\rho_o}{62.42796} = 0.7206 \text{ g/cm}^3$$

Calculate the surface tension between the oil and water phases.

$$\sigma_{hw} = \left[ \frac{1.58(\rho_w - \rho_h) + 1.76}{T_r^{0.3125}} \right]^4$$

## Symbols

$B_g$  = gas FVF, ft<sup>3</sup>/scf

$B_o$  = oil FVF, bbl/STB

$B_{ob}$  = oil formation volume at bubble point pressure, bbl/STB

$c_o$  = oil isothermal compressibility, Lt<sup>2</sup>/m, psi<sup>-1</sup>

$c_{ob}$  = oil isothermal compressibility at bubble point, Lt<sup>2</sup>/m, psi<sup>-1</sup>

$K_w$ = Watson characterization factor, $^{\circ}\text{R}^{1/3}$	$W_o$ = weight of crude oil, m
$M_g$ = gas molecular weight, m, lbm/lbm mol	$x_g$ = gas "component" mole fraction in oil
$M_{go}$ = gas/oil mixture molecular weight, m, lbm/lbm mol	$x_o$ = oil "component" mole fraction in oil
$M_o$ = oil molecular weight, m, lbm/lbm mol	$y_g$ = gas "component" mole fraction in gas
$M_{og}$ = oil-gas mixture molecular weight, m, lbm/lbm mol	$y_{N_2}$ = mole fraction $N_2$ in surface gas
$p$ = pressure, m/Lt <sup>2</sup> , psia	$y_o$ = oil "component" mole fraction in gas
$p_b$ = bubble point pressure, m/Lt <sup>2</sup> , psia	$Z$ = gas compressibility factor
$p_{bN_2}$ = bubble point pressure of oil with $N_2$ present in surface gas, m/Lt <sup>2</sup> , psia	$\gamma_{API}$ = oil API gravity
$p_{bh}$ = bubble point pressure of oil without nonhydrocarbons, m/Lt <sup>2</sup> , psia	$\gamma_g$ = gas specific gravity, air = 1
$p_f$ = bubble point pressure factor, psia/ $^{\circ}\text{R}$	$\gamma_{gc}$ = gas specific gravity adjusted for separator conditions, air = 1
$p_r$ = pressure ratio (fraction of bubble point pressure)	$\gamma_{ghc}$ = gas specific gravity of hydrocarbon components in a gas mixture, air = 1
$R_s$ = solution GOR, scf/STB	$\gamma_{gs}$ = separator gas specific gravity, air = 1
$T$ = temperature, T, $^{\circ}\text{F}$	$\gamma_o$ = oil specific gravity
$T_{abs}$ = temperature, T, $^{\circ}\text{R}$	$\mu_o$ = oil viscosity, m/Lt, cp
$T_b$ = mean average boiling point temperature, T, $^{\circ}\text{R}$	$\mu_{ob}$ = bubble point oil viscosity, m/Lt, cp
$T_{cg}$ = gas pseudocritical temperature, T, $^{\circ}\text{R}$	$\mu_{od}$ = dead oil viscosity, m/Lt, cp
$T_{cm}$ = mixture pseudocritical temperature, T, $^{\circ}\text{R}$	$\rho_g$ = gas density, m/L <sup>3</sup> , lbm/ft <sup>3</sup>
$T_{co}$ = oil pseudocritical temperature, T, $^{\circ}\text{R}$	$\rho_o$ = oil density, m/L <sup>3</sup> , lbm/ft <sup>3</sup>
$T_r$ = reduced temperature, T	$\rho_{ob}$ = bubble point oil density, m/L <sup>3</sup> , lbm/ft <sup>3</sup>
$T_{sc}$ = temperature at standard conditions, T, $^{\circ}\text{F}$	$\rho_w$ = water density, m/L <sup>3</sup> , g/cm <sup>3</sup>
$V$ = volume, L <sup>3</sup>	$\sigma_{hw}$ = hydrocarbon/water surface tension, m/t <sup>2</sup> , dynes/cm
$V_o$ = volume of crude oil, L <sup>3</sup>	$\sigma_{go}$ = gas/oil surface tension, m/t <sup>2</sup> , dynes/cm
$W_g$ = weight of dissolved gas, m	$\sigma_{od}$ = dead oil surface tension, m/t <sup>2</sup> , dynes/cm



# Rate of Reaction

The rate of reaction is the rate at which the moles or mass of reactants are depleted or products formed with respect to time per unit volume (or per unit weight or surface of catalyst in case of solid catalyzed reactions) of the reactor. Thus:

$$r_A = (1/V)(dN_A/dt) = dC_A/d_t$$

$N_A$  is the moles of  $A$  in the reactor at any time,  $t$  is the time in seconds and  $V$  is the volume of the reactor. From concentration of reactant  $A$  data taken for different reaction time,

the rate can be evaluated from the above relation. The rate is also conveniently expressed as a function of  $C_A$ :

$$r_A = kC_A^n$$

where  $n$  is the order of reaction and may be any value positive or negative integer that is specific for the reaction which may be first order ( $n = 1$ ), second order ( $n = 2$ ), third order ( $n = 3$ ), and even fractional order, many reactions also manifest a more complicated reaction order especially the multiple or reversible reactions.



# Reactor Types

Chemical reactors (reactors, reactor vessels) are used widely in the natural gas and petroleum industries to purify feedstocks and convert feedstocks into products. This is naturally facilitated by chemical reactions. The choicer of the reactor is dictated by the nature of the reaction and the reaction parameters – high pressure or low pressure, high temperature or low temperature. The classification of the reactor type is mainly based on the number of phases present in the reactor since the character of reactive phases to

a large extent decides the physical configuration of reactor equipment. Furthermore, homogeneous or homogeneously catalyzed reactions can be facilitated in a simple tube or tank reactors but for heterogeneous catalytic reactions the reactor typically has a solid catalyst phase, which is not consumed as the reaction takes place. Thus, heterogeneous catalytic reactions are commonly carried out in packed bed reactors, in which the reacting gas or liquid flows through a catalyst bed.

**Table 1** Various reactor-types.

<i>Homogeneous reactors</i>
Only one phase (gas or liquid); homogeneous catalyst Examples: Tube reactor (plug flow reactor, Tank reactor (stirred tank reactor, CSTR), batch reactor, semi-batch reactor.
<i>Heterogeneous catalytic two-phase reactors</i>
Two phases: one fluid phase; gas or liquid phase; solid catalyst; reaction takes place on the catalyst surface Examples: packed bed, moving bed, fluidized bed.
<i>Heterogeneous catalytic three-phase reactors</i>
Three phases: gas, liquid, and solid catalyst; reaction takes place on the catalyst surface
<i>Gas-liquid reactors</i>
A gas phase and a liquid phase; homogenous catalyst; reaction takes place in the liquid phase Examples: absorption column, bubble column, tank reactor, reactive distillation column monolith reactors
<i>Liquid-liquid reactors</i>
Two liquid phases; homogeneous catalyst; reaction can take place in both phases Examples: column reactor, mixer-settler reactor.
<i>Fluid-solid reactors</i>
Two or three phases; one fluid phase (gas/liquid); one reactive solid phase; reaction between the solid phase and the gas/liquid phase Examples: packed bed, fluidized bed

**Table 2** Examples of reactors used in the natural gas and petroleum industries.

Processes:
Catalytic cracking, isomerization, hydrogenation dearomatization, dehydrogenation, reforming, steam reforming, desulfurization, metal removal, hydro-oxygenation, methane activation, etherification, benzene-toluene-xylene (BTX) process], <i>Reactor types:</i> Catalytic two- and three-phase processes; packed and fluidized beds, trickle beds, bubble columns, slurry reactors
Petrochemical processes
Manufacture of polyethylene, polypropylene, polystyrene, polyvinyl chloride, polyether derivatives, maleic anhydride, phthalic anhydride, phenol, acetone <i>Reactor types:</i> Packed beds, tube reactors, tank reactors
Extraction processes
Deasphalting, manufacture of solvents, extraction using chemicals, base oils for lubricating oil manufacture <i>Reactor types:</i> Columns, tank reactors for mixing-settling
Gas cleaning
Absorption <i>Reactor types:</i> Columns, tanks
Combustion processes
Combustion of resids, coke, and other solid fuels <i>Reactor types:</i> Packed and fluidized beds

# Recovery Methods

There are several methods for crude oil recovery that vary in their respective efficiency (Table 1, Table 2). Typically, less than one-third of the original oil in place can be produced through primary production, i.e., most of the original oil in place in the reservoir is left behind in the reservoir. In some cases, primary production is not possible at all. This is especially true of low *viscosity* crude oil. In addition, recovery of such highly viscous crude oils may not even be attempted and producers apply tertiary recovery methods directly to

crude oil recovery and bypass any attempts at primary and/or secondary recovery.

Each of the methods of obtaining additional oil recovery from a reservoir typically requires a greater knowledge of that reservoir and the fluid characteristics than may be necessary for primary recovery. Displacement methods require the movement of a volume of injected fluid and reservoir fluid from one part of the reservoir to another. If sufficient information is available petroleum engineers are able to

**Table 1** Methods for petroleum recovery.

<b>Conventional Oil Recovery</b>	Primary Recovery	Natural Flow Artificial Lift	Pump Gas Lift Other	
	Secondary Recovery	Waterflood Pressure Maintenance	Water Gas Injection	
<b>Enhanced Oil Recovery</b>	Tertiary Recovery	Thermal Methods	Steam Soak Steam Drive Steam Flood Cyclic Steam Injection Hot Water Drive Combustion	
		Gas Injection	Miscible/Immiscible	Hydrocarbon Injection Carbon Dioxide Injection Flue Gas Injection
		Chemical Injection	Alkali Flood Polymer Flood Micellar Flood Foam Injection	
		Other	Microbial Injection Oil Mining	

**Table 2** Recovery efficiency of primary methods.

Dissolved-gas drive	5 to 30% v/v of the original oil in place
Gas-cap drive	20 to 40% v/v of the original oil in place
Water drive	35 to 75% v/v of the original oil in place
Gravity drainage	up to 80% v/v of the original oil in place

approximate or simulate reservoir conditions through computer modeling so that they have some idea of what might work best. However, it is not possible to exactly simulate any given natural reservoir because of the tremendous numbers of variables previously discussed. Further, secondary

and/or enhanced methods of recovery are generally more complex. Secondary and tertiary projects are more difficult to manage. Secondary and enhanced oil recovery projects with little or no history of operation generally have a greater degree of uncertainty about the likelihood of attaining expected results. Such uncertainty should be considered in the appraisal process. In addition, some producers, having attempted primary recovery methods may opt to move immediately to tertiary recovery methods and omit the application of secondary recovery methods.

Bitumen from tar sand formations is currently recovered using mining technology as well as recently developed thermal technologies.

# Refinery Feedstocks – Corrosive Constituents

Corrosion is the deterioration a material undergoes as a result of its interaction with its surroundings. Although this definition is applicable to any type of material, it is usually reserved for metallic alloys. Of the known chemical elements, approximately 80 are metals, and about half of these can be alloyed with other metals, giving rise to more than 40,000 different alloys – each of which will have different physical, chemical, and mechanical properties, but all of them can corrode to some extent, and in different ways. Corrosion processes not only influence the chemical properties of a metal but also generate changes in its physical properties and its mechanical behavior.

Crude oil corrosivity is a function of acid content and sulfur content. Crude oils that have a high acid number and low sulfur are particularly corrosive. It is possible to develop a series of operating envelopes in terms of TAN and sulfur (i.e., corrosive sulfur compounds). For each operating envelope, a specific corrosion control action is required. The economically best option is to run to the limit of a chosen corrosion control level. This approach maximizes the

amount of corrosive crude that can be processed for a given level of corrosion control.

Experience has shown that naphthenic crudes generally first affect the vacuum transfer line and vacuum gas oil side-stream. As the total acid number of the feedstock is further increased, corrosion will affect the atmospheric transfer line and heavy atmospheric gas oil (HAGO) circuits and the bottoms of both towers. Predictive models of considerable complexity exist but the accuracy of such models may be questioned and it is more cost-effective and reliable to apply a monitoring program using hot corrosion probes to confirm the predictions of any model, and to adjust the predicted limits as necessary. By this method, a simple model can be used, and this approach has proven to be very cost-effective at many locations. While high-acid crude oils primarily affect the hot parts of the atmospheric and vacuum units, they affect downstream units as well (e.g., hydrotreater preheat trains). Some crudes have also caused overhead system corrosion because of their poor performance in the desalter.

**Table** Corrosive Constituents in Refinery Feedstocks\*.

Ammonia: nitrogen in feedstocks combines with hydrogen to form ammonia (NH <sub>3</sub> ); ammonia is used for neutralization, which in turn may combine with other elements to form corrosive compounds, such as ammonium chloride (NH <sub>4</sub> Cl).
Carbon: not corrosive but at high temperature results in carburization that causes embrittlement or reduced corrosion resistance in some alloys.
Carbon dioxide: occurs in steam reforming of hydrocarbon in hydrogen plants, and to some extent in catalytic cracking; combines with moisture to form carbonic acid (H <sub>2</sub> CO <sub>3</sub> ).
Chlorides: present in the form of salts (such as magnesium chloride and calcium chloride) originating from crude oil, catalysts, and cooling water.
Cyanides: usually generated in the cracking of high-nitrogen feedstocks; when present, corrosion rates are likely to increase.
Hydrogen: not typically a corrosive compound but can lead to blistering and embrittlement of steel; readily combines with other elements to produce corrosive compounds.
Hydrogen chloride: formed through hydrolysis of magnesium chloride and calcium chloride, it is found in many overhead (vapor) streams; on condensation, it forms highly aggressive hydrochloric acid.

(Continued)

Table Cont.

Naphthenic acids: a collective name for organic acids found in crude oils; structural aspects have not been fully characterized.
Oxygen: originates in crude, aerated water, or packing gland leaks; aerial oxygen is used in furnace combustion and catalyst (FCC) regeneration units; results in high-temperature environments which cause oxidation and scaling of metal surfaces of under-alloyed materials.
Phenols: found primarily in sour water strippers but also in some crude oils and can contribute to acidic corrosion.
Polythionic acids: sulfurous acids formed by the interaction of sulfides, moisture, and oxygen, and occurring when equipment is shut down.
Sulfur: occurs in crude; causes high-temperature sulfidation of metals, and it combines with other elements to form aggressive compounds, such as various sulfides and sulfates, sulfurous, polythionic, and sulfuric acids.
Sulfuric acid: used as a catalyst in alkylation plants and is formed in some process streams containing sulfur trioxide (SO <sub>3</sub> ) and water.

\*The constituents are listed alphabetically and not in any order of preferences; the occurrence of such substance will be feedstock and process dependent.



# Refinery Gas

The terms *refinery gas* and *process gas* are also often used to include all of the gaseous products and by-products that emanate from a variety of refinery processes. There are also components of the gaseous products that must be removed prior to release of the gases to the atmosphere or prior to use of the gas in another part of the refinery, i.e., as a fuel gas or as a process feedstock.

Petroleum refining produces gas streams that contain substantial amounts of acid gases such as hydrogen sulfide and carbon dioxide. These gas streams are produced during initial distillation of the crude oil and during the various conversion processes. Of particular interest is the hydrogen sulfide ( $\text{H}_2\text{S}$ ) that arises from the hydrodesulfurization of feedstocks that contain organic sulfur:

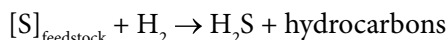

Petroleum refining involves, with the exception of heavy crude oil, *primary distillation* that results in separation into fractions differing in carbon number, volatility, specific gravity, and other characteristics. The most volatile fraction, that contains most of the gases which are generally dissolved in the crude, is referred to as *pipestill gas* or *pipestill light ends* and consists essentially of hydrocarbon gases ranging from methane to butane(s), or sometimes pentane(s).

The gas varies in composition and volume, depending on crude origin and on any additions to the crude made at the loading point. It is not uncommon to re-inject light hydrocarbons such as propane and butane into the crude oil before dispatch by tanker or pipeline. This results in a higher vapor pressure of the crude, but it allows one to increase the quantity of light products obtained at the refinery. Since light ends in most petroleum markets command a premium, while in the oil field itself propane and butane may have to be re-injected or flared, the practice of *spiking* crude oil with liquefied petroleum gas is becoming fairly common.

In addition to the gases obtained by distillation of petroleum, more highly volatile products result from the

subsequent processing of naphtha and middle distillate to produce gasoline. Hydrogen sulfide is produced in the desulfurization processes involving hydrogen treatment of naphtha, distillate, and residual fuel; and from the coking or similar thermal treatments of vacuum gas oils and residua. The most common processing step in the production of gasoline is the catalytic reforming of hydrocarbon fractions in the heptane ( $\text{C}_7$ ) to decane ( $\text{C}_{10}$ ) range.

Additional gases are produced in *thermal cracking processes*, such as the coking or visbreaking processes for the processing of heavy feedstocks. In the visbreaking process, fuel oil is passed through externally fired tubes and undergoes liquid phase cracking reactions, which result in the formation of lighter fuel oil components. Oil viscosity is thereby reduced, and some gases, mainly hydrogen, methane, and ethane, are formed. Substantial quantities of both gas and carbon are also formed in coking (both fluid coking and delayed coking) in addition to the middle distillate and naphtha. When coking a residual fuel oil or heavy gas oil, the feedstock is preheated and contacted with hot carbon (coke) which causes extensive cracking of the feedstock constituents of higher molecular weight to produce lower molecular weight products ranging from methane, via liquefied petroleum gas(es) and naphtha, to gas oil and heating oil. Products from coking processes tend to be unsaturated and olefin components predominate in the tail gases from coking processes.

Another group of refining operations that contributes to gas production is that of the *catalytic cracking processes*. These consist of fluid-bed catalytic cracking and there are many process variants in which heavy feedstocks are converted into cracked gas, liquefied petroleum gas, catalytic naphtha, fuel oil, and coke by contacting the heavy hydrocarbon with the hot catalyst. Both catalytic and thermal cracking processes, the latter being now largely used for the production of chemical raw materials, result in the formation of unsaturated hydrocarbons, particularly ethylene

( $\text{CH}_2=\text{CH}_2$ ), but also propylene (propene,  $\text{CH}_3\text{CH}=\text{CH}_2$ ), *iso*-butylene [*iso*-butene,  $(\text{CH}_3)_2\text{C}=\text{CH}_2$ ] and the *n*-butenes ( $\text{CH}_3\text{CH}_2\text{CH}=\text{CH}_2$ , and  $\text{CH}_3\text{CH}=\text{CHCH}_3$ ) in addition to hydrogen ( $\text{H}_2$ ), methane ( $\text{CH}_4$ ) and smaller quantities of ethane ( $\text{CH}_3\text{CH}_3$ ), propane ( $\text{CH}_3\text{CH}_2\text{CH}_3$ ), and butanes [ $\text{CH}_3\text{CH}_2\text{CH}_2\text{CH}_3$ ,  $(\text{CH}_3)_3\text{CH}$ ]. Diolefins such as butadiene ( $\text{CH}_2=\text{CHCH}=\text{CH}_2$ ) are also present.

A further source of refinery gas is *hydrocracking*, a catalytic high-pressure pyrolysis process in the presence of fresh and recycled hydrogen. The feedstock is again heavy gas oil or residual fuel oil, and the process is mainly directed at the production of additional middle distillates and gasoline. Since hydrogen is to be recycled, the gases produced in this process again have to be separated into lighter and heavier streams; any surplus recycle gas and the liquefied petroleum gas from the hydrocracking process are both saturated.

In a series of *reforming processes*, commercialized under names such as *Platforming*, paraffin and naphthene (cyclic non-aromatic) hydrocarbons are converted in the presence of hydrogen and a catalyst are converted into aromatics, or isomerized to more highly branched hydrocarbons. Catalytic reforming processes thus not only result in the formation of a liquid product of higher octane number, but also produce substantial quantities of gases. The latter are rich in hydrogen, but also contain hydrocarbons from methane to butanes, with a preponderance of propane ( $\text{CH}_3\text{CH}_2\text{CH}_3$ ), *n*-butane ( $\text{CH}_3\text{CH}_2\text{CH}_2\text{CH}_3$ ) and *iso*-butane [ $(\text{CH}_3)_3\text{CH}$ ].

The composition of the process gas varies in accordance with reforming severity and reformer feedstock. All catalytic reforming processes require substantial recycling of a hydrogen stream. Therefore, it is normal to separate reformer gas into a propane ( $\text{CH}_3\text{CH}_2\text{CH}_3$ ) and/or a butane stream [ $\text{CH}_3\text{CH}_2\text{CH}_2\text{CH}_3$  plus  $(\text{CH}_3)_3\text{CH}$ ], which becomes part of the refinery liquefied petroleum gas production, and a lighter gas fraction, part of which is recycled. In view of the excess of hydrogen in the gas, all products of catalytic reforming are saturated, and there are usually no olefin gases present in either gas stream.

Both hydrocracker gases and catalytic reformer gases are commonly used in catalytic desulfurization processes. In the latter, feedstocks ranging from light to vacuum gas oils are passed at pressures of 500–1000 psi ( $3.5\text{--}7.0 \times 10^3$  kPa) with hydrogen over a hydrofining catalyst. This results

mainly in the conversion of organic sulfur compounds to hydrogen sulfide,

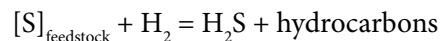

This process also produces some light hydrocarbons by hydrocracking.

The presence of impurities in gas streams may eliminate some of the sweetening processes, since some processes remove large amounts of acid gas but not to a sufficiently low concentration. On the other hand, there are those processes not designed to remove (or incapable of removing) large amounts of acid gases but which are capable of removing the acid gas impurities to very low levels when the acid gases are present only in low-to-medium concentration in the gas.

In addition to the corrosion of equipment of acid gases, the escape into the atmosphere of sulfur-containing gases can eventually lead to the formation of the constituents of acid rain, i.e., the oxides of sulfur ( $\text{SO}_2$  and  $\text{SO}_3$ ). Similarly, the nitrogen-containing gases can also lead to nitrous and nitric acids (through the formation of the oxides  $\text{NO}_x$ , where  $x = 1$  or  $2$ ) which are the other major contributors to acid rain. The release of carbon dioxide and hydrocarbons as constituents of refinery effluents can also influence the behavior and integrity of the ozone layer.

Finally, another acid gas, hydrogen chloride (HCl), although not usually considered to be a major emission, is produced from mineral matter and the brine that often accompany petroleum during production and is gaining increasing recognition as a contributor to acid rain. However, hydrogen chloride may exert severe local effects because it does not need to participate in any further chemical reaction to become an acid. Under atmospheric conditions that favor a buildup of stack emissions in the areas where hydrogen chloride is produced, the amount of hydrochloric acid in rain water could be quite high.

In summary, refinery process gas, in addition to hydrocarbons, may contain other contaminants, such as carbon oxides ( $\text{CO}_x$ , where  $x = 1$  and/or  $2$ ), sulfur oxides ( $\text{SO}_x$ , where  $x = 2$  and/or  $3$ ), as well as ammonia ( $\text{NH}_3$ ), mercaptans (R-SH), and carbonyl sulfide (COS). From an environmental viewpoint, petroleum processing can result in a variety of gaseous emissions. It is a question of degree insofar as the composition of the gaseous emissions may vary from process to process but the constituents are, in the majority of cases, the same.

# Refinery Types

To convert crude oil into desired products in an economically feasible and environmentally acceptable manner, refinery processes for crude oil are generally divided into three categories: (1) separation processes, of which distillation is the prime example, (2) conversion processes, of which coking and catalytic cracking are prime examples, and (3) finishing processes, of which hydrotreating to remove sulfur is a prime example. This has led to the evolution of different refinery types.

The simplest refinery configuration is the *topping refinery*, which is designed to prepare feedstocks for petrochemical manufacture or for production of industrial fuels. The topping refinery consists of tankage, a distillation unit, recovery facilities for gases and light hydrocarbons, and the necessary utility systems (steam, power, and water-treatment plants). Topping refineries produce large quantities of unfinished oils and are highly dependent on local markets, but the addition of hydrotreating and reforming units to this basic configuration results in a more flexible hydroskimming refinery, which can also produce desulfurized distillate fuels

and high-octane gasoline. These refineries may produce up to half of their output as residual fuel oil, and they face increasing market loss as the demand for low-sulfur (even no-sulfur) fuel oil increases.

The most versatile refinery configuration is the *conversion refinery*. A conversion refinery incorporates all the basic units found in both the topping and hydroskimming refineries, but it also features gas oil conversion plants such as catalytic cracking and hydrocracking units, olefin conversion plants such as alkylation or polymerization units, and, frequently, coking units for sharply reducing or eliminating the production of residual fuels. Modern conversion refineries may produce two-thirds of their output as unleaded gasoline, with the balance distributed between liquefied petroleum gas, jet fuel, diesel fuel, and a small quantity of coke. Many such refineries also incorporate solvent extraction processes for manufacturing lubricants and petrochemical units with which to recover propylene, benzene, toluene, and xylenes for further processing into polymers.

**Table** Refinery Types.

Refinery type	Processes	Alternate type name	Complexity	Comparative range*
Topping	Distillation	Skimming	Low	1
Hydroskimming	Distillation	Hydroskimming	Moderate	3
	Reforming			
	Hydrotreating			
Conversion	Distillation	Cracking	High	6
	Fluid catalytic cracking			
	Hydrocracking			
	Reforming			
	Alkylation			
	Hydrotreating			
Deep conversion	Distillation	Coking	Very high	10
	Coking			
	Fluid catalytic cracking			
	Hydrocracking			
	Reforming			
	Alkylation			
	Hydrotreating			

\*Indicates complexity on an arbitrary numerical scale of 1-10.

# Refinery Units – Materials of Construction and Operating Conditions

**Table** Materials of Construction and Operating Conditions for Various Refinery Units.

Unit	Material	Temp. °C	Pressure**, psi	Corrosion rate**, mpy	Typical corrosion type	Effect primarily due to
Desalter	Carbon steel	50	50	200	Localized pitting corrosion	Salt
Atmospheric distillation	Carbon steel, Cr-Mo steels, 12 Cr, 316 stainless steel, Monel, and 70-30 copper/nickel alloy	371	50	315	Localized pitting corrosion, and flow-induced localized corrosion	Naphthenic acid and sulfur, HCl in overhead
Vacuum distillation	Carbon steel, 9Cr-1Mo steel, and austenitic stainless steel	400	10	~417	Localized pitting corrosion	Naphthenic acid, sulfur, HCl in overhead
Catalytic cracking	Carbon steel and stainless steel with refractory lining, Inconel 625, alloy 800	600	100		Inter-granular SCC, graphitization, erosion	
Thermal cracking		600	100			
Hydrotreating	Carbon steel, Cr-Mo steels, alloy 825, 321 stainless steel, 347 stainless steel, alloy 800, alloy 800H	670	2,000	~137	SSC, SCC, Hydrogen flaking, Pitting corrosion	H <sub>2</sub> S, poly-thionic acid, and ammonium salts
Hydrodesulfurization	Carbon steel, 316L stainless steel, 405 stainless steel, alloy 825, 9Cr-Al, and graphitized SA 268	593	750	383	Inter-granular cracking, localized pitting corrosion	H <sub>2</sub> S
Catalytic reforming	Carbon steel and 2.25 Cr 1 Mo steel	650	360	48	Metal dusting, carburization, and localized pitting corrosion	Chloride, ammonia, caustic
Visbreaker	Carbon steel	220		16		
Coker	Carbon steel	300		20	High temperature oxidation and sulfidation	H <sub>2</sub> S

(Continued)

Table Cont.

Unit	Material	Temp. °C	Pressure**, psi	Corrosion rate**, mpy	Typical corrosion type	Effect primarily due to
Alkylation	Carbon steel, alloy 400, and Monel 400	188	60	100	Localized pitting corrosion	SO <sub>2</sub> and acid (sulfuric and hydrofluoric acid)
Gas treating	Carbon steel	128	1,250	10	Localized pitting corrosion	H <sub>2</sub> S, CO <sub>2</sub> , amine
Sour water stripper	Carbon steel, 316L stainless steel, alloy 825, Ni-alloy C-276, alloy 2205, alloy 2507 and grade 2 titanium	245	100	85	Localized pitting corrosion, erosion-corrosion	H <sub>2</sub> S, flow, and chloride
Sulfur recovery	Carbon steel, 304L stainless steel, refractory	121		16	Localized pitting corrosion	H <sub>2</sub> S

# Refractive Index and Specific Refraction

The refractive index  $n$  is the ratio of the velocity of light in a particular substance to the velocity of light in vacuum. Values reported refer to the ratio of the velocity in air to that in the substance saturated with air. Usually the yellow sodium doublet lines are used; they have a weighted mean of 589.26 nm and are symbolized by D. When only a single refractive index is available, approximate values over a small temperature range may be calculated using a mean value of 0.000 45 per degree for  $dn/dt$ , and remembering that  $n_D$  decreases with an increase in temperature. If a transition point lies within the temperature range, extrapolation is not reliable.

Refractive index of selected hydrocarbons.

Hydrocarbon	$n^*$
Pentane	1.3579
Hexane	1.3749
Heptane	1.3876
Octane	1.3975
Nonane	1.4054
Decane	1.4119
Nonadecane	1.4409
Eicosane	1.4425
Cyclopentane	1.4064
Cyclohexane	1.4266
Cycloheptane	1.4449
Benzene	1.5011
Toluene	1.4961
Ethylbenzene	1.4959
Propylbenzene	1.4920
Tetralin	1.5461
Decalin	1.4811

\* $n$ : Refractive index at 20 °C (68 °F) at the wavelength of the sodium D line

The *specific refraction*  $r_D$  is given by the Lorentz and Lorenz equation:

$$r_D = [(n_D^2 - 1)/(n_D^2 + 2)]/(1/\rho)$$

In the equation,  $\rho$  is the density at the same temperature as the refractive index,  $r$ , and is independent of temperature and pressure. The molar refraction is equal to the specific refraction multiplied by the molecular weight. It is a more or less additive property of the groups or elements comprising the compound.

Relationship of Refractive Index to Dielectric Constant.

Material	Refractive Index $n$	$n^2$	Dielectric Constant
Benzene	1.501	2.25	2.283
Cyclohexane	1.427	2.04	2.055
n-Hexane	1.375	1.89	1.89
n-Heptane	1.388	1.93	1.933
Kerosene	1.449	2.1	2.135
Paraffin oil	1.481	2.19	2.195
Vaseline	1.48	2.19	2.078





# Relative Density

The statement is often made that natural gas is lighter than air. This statement often arises because of the continued insistence by engineers and scientists that the properties of a mixture are determined by the mathematical average of the properties of the individual constituents of the mixture. Such mathematical bravado and inconsistency of thought is detrimental to safety and needs to be qualified.

Relative to air, methane is less dense (Table) but the other hydrocarbon constituents of unrefined natural gas (i.e., ethane, propane, butane, and higher molecular weight hydrocarbons) are denser than air (Figure). Therefore, should a natural gas leak occur in field operations, especially where the natural gas contains constituents other than methane, only methane dissipates readily into the air whereas the

other hydrocarbon constituents that are heavier than air do not readily dissipate into the atmosphere. This poses considerable risk if these constituents of natural gas accumulate or pool at ground level when it has been erroneously assumed that natural gas is lighter than air.

**Table** Boiling point and density of methane relative to air and water.

- Boiling Point (760 mm Hg): -161.5° C (-258.7° F)
- Gas Specific Gravity: 0.55 to 0.64 (air = 1.00)
- Specific Gravity of Liquefied Natural Gas: 0.42 to 0.46 (water = 1.00)
- Gas Density (varies slightly): 0.0438 lb/scf

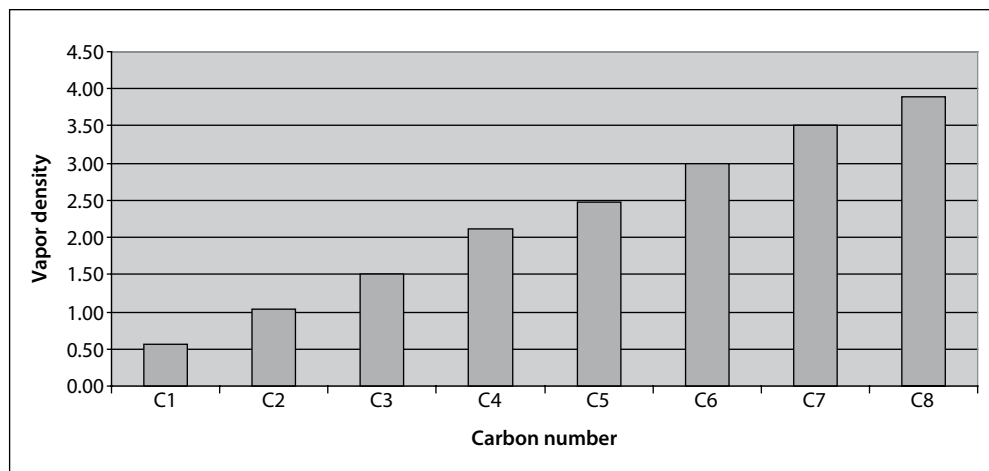

**Figure** Carbon number and vapor density (relative to air = 1.0) of natural gas hydrocarbons (up to octane, C<sub>8</sub>H<sub>18</sub>).



# Relative Permeability

The *relative permeability* is the ratio of the effective permeability of a particular fluid to a base permeability of the rock. Since it is both a rock property and a fluid property, relative permeability is a difficult concept to understand. The permeability of a rock depends upon the type of fluid that

is flowing, characteristics of the rock surface and the pore structure geometry. The presence of more than one fluid at the same time in the pore space of a rock also affects the permeability. Relative permeability ranges from zero to one, and are a function of the fluid saturation.



# Relative Volatility

Relative volatility can be estimated using the equilibrium vaporization constant  $K$ , which is defined as:

$$K_i = Y_i/X_i$$

$Y_i$  is the mole fraction of component  $i$  in the vapor phase,  $X_i$  is the mole fraction of component  $i$  in the liquid

phase. For distillation, the relative volatility,  $\alpha$ , is calculated from:

$$\alpha = K_i/K_j$$

In this equation,  $i$  and  $j$  represent two components that are to be separated.



# Reserves – Estimation

Estimation of oil and gas reserves in a discovered reservoir is one of the most important factors in evaluating the discovery and deciding on its viability for commercial development. To determine the volume of oil or gas present in the reservoir, the bulk volume of the reservoir ( $V_b$ ) is first determined using the available reservoir description data. The volume of fluids in the pore spaces of the reservoir rock is then calculated by multiplying the bulk volume by the rock porosity ( $\phi$ ); this is also known as the pore volume of the rock. Porosity is a property of the rock defined as the ratio of the volume of the pore spaces within the rock to the bulk volume of the rock. The pore volume is normally occupied by oil (or gas) and water. The fraction of the pore volume occupied by water is known as the water saturation ( $S_w$ ). The porosity and initial water saturation are determined from the logs and core samples obtained from the exploratory wells. Therefore, the initial volume of oil ( $V_o$ ) at the reservoir conditions is determined by:

$$V_o = V_b \phi (1 - S_w)$$

This volume of oil is called the initial oil in place (IOIP) or the original oil in place (OOIP). This method of estimating the original oil in place is known as the volumetric method. Other methods (the material balance method and decline curve method) also exist for estimating the original oil in place.

It is impossible to recover all of the original oil in place – certain forces within the reservoir rock prevent the movement of some oil from the rock to the well. The fraction of the original oil in place that could be recovered is called the recovery factor ( $E\gamma$ ) and the total recoverable volume of oil ( $E\gamma V_o$ ) is called the proven reserves.

The proven reserve for a reservoir changes with time as a result of three factors. First, the volume of oil in place decreases as oil is produced from the reservoir. Second, as more oil is produced, more reservoir data become available, which could change or modify the initial estimate of the original oil in place. Third, new developments and improvements in recovery and production methods may increase the possible recovery factor, allowing the proven reserve of any field to be continuously updated.





# Reserves

The definitions used to describe petroleum *reserves* are often misunderstood because they are not adequately defined. Therefore, as a means of alleviating this problem, it is pertinent to consider the definitions used to describe the amount of petroleum that remains in subterranean reservoirs. Petroleum is a *resource*; in particular, it is a *fossil fuel resource*. A *resource* is the entire commodity that exists in the sediments and strata, whereas the *reserves* represent that fraction of a commodity that can be recovered economically. However, the use of the term *reserves* as being descriptive of the resource is subject to much speculation. In fact, it is subject to word variations! For example, reserves are classed as *proved*, *unproved*, *probable*, *possible*, and *undiscovered*.

*Proven reserves* are those reserves of petroleum that are actually found by drilling operations and are recoverable by means of current technology. They have a high degree of accuracy and are frequently updated as the recovery operation proceeds. They may be updated by means of reservoir characteristics, such as production data, pressure transient analysis, and reservoir modeling.

*Probable reserves* are those reserves of petroleum that are nearly certain but about which a slight doubt exists. *Possible reserves* are those reserves of petroleum with an even greater degree of uncertainty about recovery but about which there is some information. An additional term *potential reserves* is also used on occasion; these reserves are based upon geological information about the types of sediments where such resources are likely to occur and they are considered to represent an educated guess. Then, there are the so-called *undiscovered reserves*, which are little more than figments of the imagination! The terms *undiscovered reserves* or

*undiscovered resources* should be used with caution, especially when applied as a means of estimating reserves of petroleum reserves. The data are very speculative and are regarded by many energy scientists as having little value other than unbridled optimism.

The term *inferred reserves* is also commonly used in addition to, or in place of, *potential reserves*. Inferred reserves are regarded as of a higher degree of accuracy than potential reserves, and the term is applied to those reserves that are estimated using an improved understanding of reservoir frameworks. The term also usually includes those reserves that can be recovered by further development of recovery technologies.

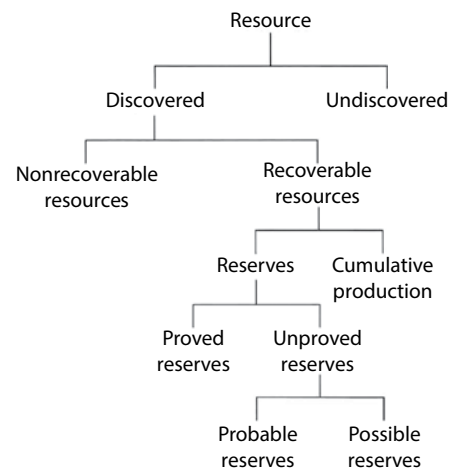

**Figure** Illustration of the various reserve groups.



## Reservoir Crude Oil

Reservoir crude oil is classified as a visco-elastic fluid which exerts a normal stress in addition to the tangential stress developed while in flowing condition. Flow behavior of this type of fluid cannot be directly expressed in terms of Newtonian viscosity. For steady-state flow, relation for pseudoplastic fluid may be more applicable. Thus:

$$\tau = k (-du/dx)^n$$

In this equation,  $\tau$  is the shear stress,  $u$  and  $x$  are the velocity and distance,  $du/dx$  is the corresponding shear rate,  $k$  is the consistency factor (but not Newton's viscosity), and  $n < 1$ . However,  $k$  can be related with Newton's viscosity and

can be used for the effect of temperature and other factors affecting viscosity.

The production rate is inversely proportional to viscosity of oil and directly to pressure of the reservoir. In the well, recoverability of oil with respect to water is measured by the ratio ( $\xi$ ) of viscosities of oil to water. Thus:

$$\xi = \mu_{oil} / \mu_{water}$$

In the equation,  $\mu_{oil}$  and  $\mu_{water}$  are the viscosities of oil and water respectively. Lower the value of  $\xi$ , the greater is the oil cut and vice-versa. This value increases with the age of the well and thus increases the water cut in the production.



## Reservoir – Drive Mechanisms

Another way of classifying petroleum reservoirs, which is of interest to reservoir and production engineers, is to characterize the reservoir according to the production (drive) mechanism that is responsible for displacing the oil from the formation into the wellbore and then to the surface. There are three main drive mechanisms: (1) solution gas drive, (2) gas cap drive, and (3) water drive.

*Solution gas drive reservoirs* are dependent on the reservoir pressure and temperature which determines the amount of gas dissolved in the crude oil. This solution gas would evolve out of the oil only if the pressure is lowered below a certain value (the bubble point pressure). When a well is drilled through the reservoir and the pressure conditions are controlled to create a pressure that is lower than the bubble point pressure, the liberated gas expands and drives the oil out of the formation and assists in lifting it to the surface. Reservoirs with the energy of the escaping and expanding dissolved gas as the only source of energy are called solution gas drive reservoirs. This drive mechanism is the least effective of all drive mechanisms; it generally yields recoveries between 15 and 25% v/v of the oil in the reservoir.

*Gas cap drive reservoirs* are dependent upon the presence of a gas cap above the oil. The formation of this gas cap is due to the presence of a larger amount of gas than can be dissolved in the oil at the pressure and temperature of the

reservoir. The excess gas is segregated by gravity to occupy the top portion of the reservoir. In these reservoirs, the oil is produced by the expansion of the gas in the gas cap, which pushes the oil downward and fills the pore spaces formerly occupied by the produced oil. In most cases, however, solution gas is also contributing to the drive of the oil out of the formation. Under favorable conditions, some of the solution gas may move upward into the gas cap and, thus, enlarge the gas cap and conserve its energy. Reservoirs produced by the expansion of the gas cap are known as gas cap drive reservoirs. This drive is more efficient than the solution gas drive and could yield recoveries between 25 and 50% v/v of the original oil in place.

*Water drive reservoirs* exist as continuous, porous formations with the oil/gas occupying only a small portion of the formation. In such cases, the formation below the oil/gas is saturated with salt water at very high pressure. When oil/gas is produced by lowering the pressure in the well opposite the petroleum formation, the salt water expands and moves upward, pushing the oil/gas out of the formation and occupying the pore spaces vacated by the produced oil/gas. The movement of the water to displace the oil/gas retards the decline in oil, or gas pressure, and conserves the expansive energy of the crude oil. This could yield recovery up to 50% v/v of the original oil in place.



# Reservoir Pressure

The discovery pressure of the fluid in a reservoir is related to the weight of its overburden and how much of this is supported by the reservoir rock. The overburden weight is expressed through a pressure that represents the total vertical stress caused by the combined weight of the fluid and rock. The overburden pressure is also called the lithostatic, geostatic, earth, or rock pressure. The support from the reservoir is expressed through a grain pressure, the load carried by grain-to-grain contacts. It is the normal component of the effective stress. Based on a static force balance, the overburden pressure  $P_o$  is equal to the sum of the fluid or pore pressure  $P_p$  and the grain pressure  $P_g$ :

$$P_o = P_p + P_g$$

The overburden pressure is expressed as a pressure gradient, i.e., its change in pressure with respect to depth. The overburden pressure gradient is directly related to the bulk density of the reservoir and overburden materials. The bulk density is, in turn, a function of the grain (rock) density, fluid (water) density, and porosity. The bulk density  $\hat{\rho}_b$  is given by:

$$\hat{\rho}_b = \hat{\rho}_w \phi + (1 - \phi)\hat{\rho}_r$$

where  $\hat{\rho}_w$  and  $\hat{\rho}_r$  are the water and rock (grain) densities, respectively. This equation assumes water is the only

interstitial fluid. The bulk density is related to the overburden pressure:

$$p_o = \hat{\rho}_b gD$$

where  $D$  is the reservoir subsurface vertical depth,  $g$  is the gravitational acceleration, and  $p_o$  is a relative (gauge) pressure. The product  $\hat{\rho}_b g$  is the *specific weight*, the force per unit volume or pressure per unit length (i.e., pressure gradient).

The grain density of virtually all sedimentary rocks is approximately equal to 2.65 g/cm<sup>3</sup> ( $\pm 3$  to 5). Water density is approximately 1 g/cm<sup>3</sup>. These densities correspond to the following specific weights:  $\hat{\rho}_r g = 1.15$  and  $\hat{\rho}_w g = 0.433$  psi/ft, respectively. Thus, the overburden pressure gradient is generally between 0.433 (if the overburden were fluid with no rock) and 1.15 psi/ft (if there were no water)- a typical value is 1.00 psi/ft.

Pore pressure gradients at discovery are between the hydrostatic and overburden pressure gradients. The hydrostatic pressure gradient is the pressure gradient of the fluids. If the fluid column contains only water, the hydrostatic pressure gradient is 0.433 psi/ft. Because of the effects of dissolved solids in the water, the hydrostatic pressure gradient may be as large as 0.54 psi/ft.





# Reservoir – Types and Classification

A conventional petroleum reservoir is a dome or vault of impermeable rock, formed by folding or faulting of the rock layers or by the rise of salt domes, with permeable rocks beneath it. In those permeable rocks there may be a layer of natural gas on top, with petroleum below. Beneath the oil is usually a layer of rock soaked with water or brine. However, not all reservoirs have the above characteristics and there are also unconventional or continuous reservoirs in which the oil is not trapped as described above. Therefore, reservoir characterization is an essential part of petroleum technology and offers an understanding or indication of the applicable method(s) of recovery.

## *Types:*

Petroleum reservoirs exist in many different sizes and shapes of geologic structures. It is usually convenient to classify the reservoirs according to the geologic structure and their production (drive) mechanism.

- Dome-shaped and anticline reservoirs, which are formed by the folding of the rock layers. The dome is circular in outline, and the anticline is long and narrow. Oil or gas moved or migrated upward through the porous strata where it was trapped by the sealing cap rock and the shape of the structure.
- Faulted reservoirs, which are formed by shearing and offsetting of the strata (faulting). The movement of the nonporous rock opposite the porous formation containing the oil/gas creates the sealing. The tilt of the petroleum-bearing formation and the faulting trap the oil/gas in the reservoir.
- Salt-dome reservoirs, which have the shape of a dome that was formed due to the upward movement of a large, impermeable salt dome that deformed and lifted the overlying strata. The natural gas or crude oil is trapped between the cap rock and an underlying impermeable rock layer, or

between two impermeable layers of rock and the salt dome.

- Unconformities are formed as a result of an unconformity where the impermeable cap rock was laid down across the cutoff surfaces of the lower strata.
- Lens-type reservoirs in which the crude oil bearing porous formation is sealed by the surrounding, non-porous formation. Irregular deposition of sediments and shale at the time the formation was laid down is the probable cause for this abrupt change in formation porosity.
- Combination reservoirs are reservoirs in which combinations of folding, faulting, abrupt changes in porosity, or other conditions create the trap from this type of reservoir.

## *Classification:*

Petroleum reservoir characterization is the process of identifying and quantifying those properties of a given petroleum reservoir which affect the distribution and migration of fluids within that reservoir. These aspects are controlled by the geological history of the reservoir. Furthermore, the ultimate goal of a hydrocarbon reservoir characterization study is the development of a reasonable physical description of a given reservoir. This physical description can then be used as a basis for simulation studies, which, in turn, are used to assess the effectiveness of various recovery strategies. An accurate physical description of the reservoir often will lead to the maximum production of hydrocarbons from the reservoir. A general classification scheme has been developed for petroleum reservoirs contained in US Department of Energy's tertiary-oil-recovery information system (TORIC). This resulted in the classification and description of 2,300 light-oil reservoirs (greater than 20° API), collectively containing 308 billion bbl of *original oil-in-place* (OOIP).

The reservoirs fell within 173 combinations defined by their lithology, depositional environment, structural

deformation, and diagenetic over-print. These groups were then collapsed into a smaller number of classes while maintaining meaningful descriptions of the processes that produce reservoir heterogeneity at the interwell scale. Using a basic classification system relying on lithology and depositional environment, with subclasses reflecting post-deposition processes, would suffice. As a result, 22 geologic classes, 16 clastic, and 6 carbonate, with structural subclasses for clastic and diagenetic subclasses for carbonates, were defined.

Sixteen clastic classes were derived from 28 clastic depositional systems described in the classifier. These classes contain silico-clastic rocks deposited in the paleo-environmental setting indicated by their names. While some are fairly uniform environments, such as those of the Aeolian class, others are complex, as in the various deltaic environments.

For most reservoirs, relatively refined description of the depositional processes was possible (e.g., fluvial-dominant deltas), but for some, the unavailability of data or the complexity of the depositional processes required broader, undifferentiated classes (e.g., fluvial, strand plain, delta).

Heterogeneity due to the post-deposition structural and diagenetic history of a reservoir can have an overriding influence on the flow of oil and other fluids. These descriptive reservoir modifiers provided the basis for defining subclasses.

In clastic reservoirs, variations in types of structural controls on heterogeneity relative to diagenesis suggested that clastic reservoirs could be classified by combining depositional environment with structural, rather than diagenetic, elements. Compaction and cementation was indicated as the principal diagenetic event in 89% of clastic reservoirs analyzed. Structural modifiers include fracturing, faulting, and folding, all of which can greatly affect reservoir heterogeneity. The term *structured* was adopted to describe interwell heterogeneity that result from these structural overprints on

the reservoir. In combination, one-third of the clastic reservoirs have some sort of structural overprint. The resulting *structured* and *unstructured* subclassifications were useful in describing this lithology.

Six carbonate classes were derived from 20 individually described carbonate depositional systems defined in the classifier. These carbonate reservoirs classified well deposited in marine or near-marine settings. The class names are descriptive of the location or conditions under which deposition occurred. However, the shallow shelf/restricted carbonate class contains reservoir rock deposited in the near-shore sub-tidal as well as the shallow shelf environment. In carbonate reservoirs, diagenetic factors have significant effects on heterogeneity. Therefore, diagenetic factors were used as the basis of subclasses. Structural features of the described carbonate reservoirs were not found to vary substantially (88% of the carbonate reservoirs are described as unstructured). Therefore, structural features were not used to define carbonate subclasses.

The occurrence and variability of the diagenetic descriptors, however, justified the differentiation of carbonated reservoirs into three carbonate diagenetic subclasses. These subclasses are: dolomitization, massive dissolution, the other. The subclass *other* combines compaction/cementation, grain enhancement, and silicification. Five of the six carbonate classes are divided into three subclasses. The sixth, slope-basin, contains only reservoirs described by the other diagenetic processes, the single subclass in the class.

The grouping of the reservoirs into classes created a smaller number of research targets, yet the distinctness of the reservoir is preserved. The results of the classification effort present a focus for specific studies. Reservoirs within these classes are expected to manifest distinct types of reservoir heterogeneity as a consequence of their similar lithology and depositional histories. The creation of subclasses assists in the analysis of the impact of post-deposition events on reservoir heterogeneity.

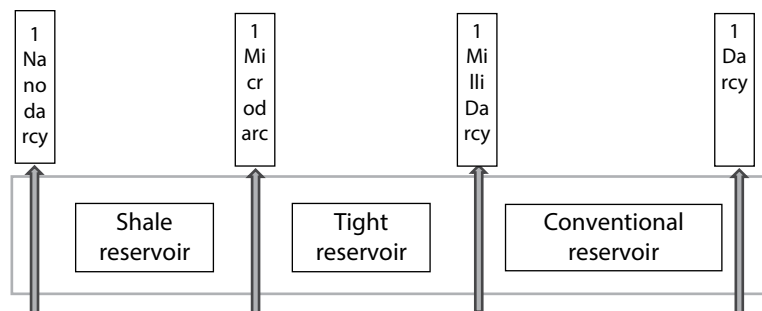

**Figure** Representation of differences in permeability of shale reservoirs, tight reservoirs, and conventional reservoirs.

# Reservoir

A reservoir is a rock formation below the earth's surface containing petroleum or natural gas. The naturally occurring hydrocarbons are trapped by overlying rock formations with lower permeability. Most hydrocarbon reservoirs consist of a trap, a seal, and a porous and permeable reservoir matrix. Exceptions can occur in the case of tar sand and oil shale.

An integral part of the reservoir trap, a seal is an impermeable barrier that does not allow the lateral or vertical migration of hydrocarbons. While a trap is necessary for the accumulation of hydrocarbons, it must consist of an impermeable layer that will not allow the migration of hydrocarbons through it. Common types of seals are shales, salt domes, matrix cementation, and impermeable unconformities.

The traps required in the last step of the reservoir formation process have been classified into two types: (1) structural trap and (2) stratigraphic trap; a reservoir can be formed by one kind of trap or a combination of both.

Structural traps consist of folds or faults in the reservoir rock in which hydrocarbons may accumulate as they migrate from source rocks. Examples of structural traps include anticlines, faults, and salt domes.

Stratigraphic traps consist of non-structural variations in porosity in a form that may allow the accumulation of hydrocarbons. Generally, a stratigraphic trap may be classified as a disconformity (variation in rock properties across parallel beds), an angular unconformity (a disconformity across non-parallel beds), or lenticular (porosity and permeability variations in all directions).

Within the body of the reservoir, hydrocarbons are stored in a porous and permeable rock matrix. Porosity (the void space in a porous medium) is required for hydrocarbons to accumulate. Permeability is required for the mobility of hydrocarbons and for commercial production of hydrocarbons from the reservoir. Porosity of commercial hydrocarbon reservoirs generally ranges from about 5% to 30% although extremes in porosity values may be encountered.

Like porosity, permeability may have extreme values under special conditions. However, permeability of most hydrocarbon reservoirs lies in the range of a few milliDarcys to several Darcys.

Heavy oils typically occur in geologically young reservoirs (from the Cretaceous) and, because these reservoirs are shallow, they have less effective seals and are thus exposed to conditions conducive to the formation of heavy oils. The fact that most heavy oil reservoirs are shallow is an indication that many of them were discovered as soon as human beings settled nearby. Collecting oil from seeps and digging by hand were the earliest and most primitive means of recovery, followed by mining and tunneling.

However, heavy oil resources, along with tar sand bitumen resources can be subdivided into a number of different categories based on their location, environment, and characteristics. The following categorization is not all-encompassing but does illustrate the wide variety among heavy oil resources:

- Shallowest resources (<150 feet depth).
- Shallow resources (150 to 300 feet deep with no cap rock seal).
- Medium-depth resources (300 to 1,000 feet deep, cap rock seal, pressure <200 psi).
- Intermediate-depth resources (1,000 to 3,000 feet, pressure >200 psi).
- Deep resources (>3,000 feet deep).
- Carbonate resources (tight rock formations, variable porosity).
- Thinly bedded resources (<30 feet thick)
- Highly laminated resources (low vertical permeability, often shale layering).

Furthermore, the properties of the heavy oil such as composition and viscosity are equally important but have not been included in the above list. If the oil properties were to

be included, the complexity of the heavy oil resources can increase by at least an order of magnitude.

In addition, many heavy oil reservoirs have been found in Arctic regions and offshore beneath the continental shelves of Africa and North and South America. Heavy oil has also been discovered beneath the Caspian, Mediterranean, Adriatic, Red, Black, North, Beaufort, and Caribbean seas, as well as beneath the Persian Gulf and the Gulf of Mexico.

Most of the heavy oil currently recovered is produced from underground reservoirs. However, surface seepage of crude oil and natural gas are common in many regions. In fact, it is the surface seepage of oil that led to the first use of the high boiling material (heavy oil or bitumen) in the Fertile Crescent. It may also be stated that the presence of active seeps in an area is evidence that oil and gas are still migrating.

Heavy oil reservoirs are usually shallow (up to 1,000 meters below the surface line) and therefore present low reservoir temperatures (between 40 and 60 °C). Low

sedimentary overburden tends to ease the biodegradation of the oil mainly when associated to bottom aquifers and also contributes to creating geomechanically fragile structures where faults occur, creating geological compartments and heterogeneities. Such kind of reservoir may also have low seal pressure, which may cause the dissolved gas to leave the oil, increasing its viscosity. The reservoir lithology is usually sandstones deposited as turbidites; high permeability (in the order of Darcies) and porosity are quite common. High permeability may compensate the elevated oil viscosity, resulting in high well productivities.

Although one of the characteristics of heavy oil is that it is mobile in the reservoir, i.e., the pour point of the oil is lower than the reservoir temperature, some reservoirs have a sufficiently high temperature that heavy oil can be produced with essentially conventional methods. Once the oil is produced at the surface, the temperature differential between the reservoir (higher temperature) and the surface (lower temperature) might be such that the oil resorts to the more familiar extremely viscous fluid.

# Resid Upgrading Technologies

Several kinds of residue upgrading processes are now commercially proven, such as (1) fixed bed, (2) moving bed (3) ebullated bed processes, and (4) slurry bed processes (Table 1 and Table 2) but the fixed bed processes have remained processes of choice used to remove sulfur from for sulfur removal (Tables 1–4). In terms of advancement of ebullated-bed technology, the original H-Oil process has evolved, during the past decade, into various configurations that have the potential to play major roles in heavy feedstock upgrading up to and beyond the year 2020.

The H-Oil<sub>DC</sub> process (previously known as the T-Star process) is a specially engineered, ebullated-bed process for the treatment of vacuum gas oils. Because of the ability to replace the catalyst bed incrementally, the H-Oil<sub>DC</sub> reactor can operate indefinitely – typically, four to five years between turnarounds to coincide with the inspection and

maintenance schedule for a fluid catalytic cracking unit. The difficult processing requirements which result from stricter environmental regulations and the processing of heavy feedstocks makes H-Oil<sub>DC</sub> a preferred choice for pretreatment of fluid catalytic cracker feedstocks.

The H-Oil<sub>HCC</sub> is a heavy crude conversion process that produces synthetic crude oil. The objective of the unit is to enable just enough conversion to reduce viscosity and increase stability so that the product can be readily transported to an upgrading center. Among the improvements made to the traditional H-Oil technology are the integration of an inter-stage separator between reactors in series and the application of cascade catalyst utilization. The result is (1) an increase in conversion levels, (2) an increase in product stability, and (3) reduced processing costs.

**Table 1** Hydroconversion processes.

Reactor	Process	Licensor
Fixed-bed	Continuous catalyst replacement (OCR)	Chevron Lummus Global
	UFR (Up-Flow Reactor)	Shell
		Axens
	Hycon (bunker reactor)	Shell
Ebullated-bed	Hyvahl (swing reactor)	Axens/IFP
	H-Oil	Axens/IFP
	LC-Fining	ABB Lummus
Slurry system	Micro-Cat	Exxon/Mobil
	VCC (Veba-Combi Cracking)	Veba Oel
	HDH (Hydrocracking distillation hydrotreating)	Intevep
	CASH (Chevron activated slurry hydroprocessing)	Chevron
	EST (ENI slurry technology)	ENI Technologies
	Uniflex	UOP

**Table 2** Comparison of different hydroprocessing reactor types.

Fixed bed	Moving bed	Ebullated bed	Slurry bed	
Maximum Ni + V	50–250	50–400	100–600	>300
Conversion, % w/w	50	50	80	95

**Table 3** General process parameters for ebullated bed (H-Oil and LC-Fining) processes.

Parameter	H-Oil	LC-Fining
Temperature, C	415–440	385–450
Temperature, F	780–825	725–840
Pressure, psi	2440–3000	1015–2740
Hydrogen/bbl	1410	1350
Conversion	45–90	40–95
HDS	55–90	60–90
HDM	65–90	50–95

The LC-Fining process is also an ebullated-bed process based on technology initially developed and commercially demonstrated by Cities Service, and subsequently improved and refined by ABB Lummus Global, BP (formerly Amoco Oil Company), and ChevronTexaco Corporation (formerly Chevron) (Arora and Mukherjee, 2011). The process can be tailored to the feedstocks, the degree of conversion, and the product qualities required (Gupta, 2004). Operating conditions and catalyst type and activity can be varied to achieve the desired conversion.

Whereas a typical conversion level in a fixed-bed upgrader is on the order of 35 to 50%, LC-Fining is designed for the very high conversion of heavy feedstocks at conversion levels on the order of 55 to 85%. Reactor section flow scheme and reactor internals improvements have allowed single train capacities to reach 50,000 bpd and catalyst developments have also led to decreases in catalyst consumption. The unit can be integrated with hydrotreating and hydrocracking on the same processing platform and can run continuously up to four years.

**Table 4** Comparison of different upgrading technologies.

	Fixed bed	Moving bed	Ebullated bed	Slurry bed
Maximum (Ni + V) content in feed (wppm)	120–400	500–700	>700	>700
Tolerance for impurities	Low	Low	Average	High
Maximum conversion of 550 °C (wt%)	60–70	60–70	80	90
Distillate quality	Good	Good	Good	Poor
Fuel oil stability	Yes	Yes	Borderline	No
Unit operability	Good	Difficult	Difficult	Difficult
Operating pressure, bar (psig)	140 (2100)	200 (3000)	100–200 (1500–3000)	135–205 (2000–3000)
Operating temperature, °C (°F)	400–450 (750–800)	400–450 (750–800)	420–450 (790–800)	450–480 (840–895)
Feed characterization	Low solids	High metals	High metals High solids	High asphaltenes

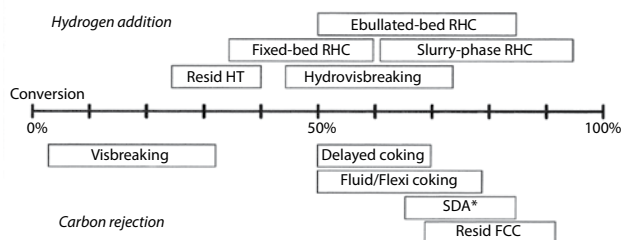

**Figure** Representation of Resid Upgrading Processes.

\*SDA: Solvent deasphalting – a process for physical separation of feedstock constituents based on polarity and molecular weight but no conversion.

HT: hydrotreating

RHC: Resid hydrocracking

FCC: Fluid catalytic cracking

# Resource Estimation

The crude oil potential of a deposit depends on pressure and temperature of the formation, surface tension, density and viscosity of oil, porosity and permeability of rock, so on and so forth. Quantum of oil and/or gas present in the reservoir pores is called oil and/or gas *in place*. The part of hydrocarbon which can be economically produced and marketed is called Reserve. The oil and gas volume/quantities can be estimated by volumetric method. Volumetric oil *in place* in million metric ton is given by the relation:

$$AH\theta(1 - s_w)\rho_o/b_o$$

where  $A$  is the area of oil pool in square kilometers,  $H$  is the oil pay thickness in meters,  $\theta$  is the porosity of the reservoir

rocks,  $\rho_o$  is the density of oil,  $b_o$  is the volume fraction of oil in the formation, and  $s_w$  is the fraction saturated by water in the pores.

For gas *in place* following relation is used:

$$AH\theta(1-s_w)p_r T_r / (Z p_s T_s)$$

where  $A$  is the area of oil pool in square kilometer,  $H$  is the oil pay thickness in meters,  $\theta$  is the porosity of the reservoir rocks,  $s_w$  is the fraction saturated by water in the pores,  $p_r$  is the reservoir pressure in the formation,  $p_s$  is the pressure at the surface of earth,  $T_r$  is the absolute temperature in the formation, and  $T_s$  is the absolute temperature at the surface.





# Retrograde Condensate Systems

Retrograde condensate systems and reservoirs are a unique phenomenon that appears among hydrocarbon mixtures. Thus, as pressure decreases in the system the amount of liquid in the reservoir increases. As pressure decreases further, liquid starts to vaporize. Between the dew point and the point where liquid vaporizes is the region of retrograde condensation. Many natural gas reservoirs behave in this manner and during production from such reservoirs, the pressure gradient formed between the reservoir pressure and the flowing bottomhole pressure may result in liquid condensation and form a condensate bank around the wellbore, reduce gas relative permeability and remain unrecoverable. Sometimes it could seize production.

Prevention of the formation of condensate involves maintaining the flowing well bottomhole pressure above the dew point pressure, which may not be a satisfactory resolution because the drawdown (reservoir pressure minus flowing bottomhole pressure) may not be sufficient enough for an efficient (economic) production rate. An alternative resolution is to allow the formation of condensate but occasionally to inject methane gas into the production well. The dissolved methane will sweep the liquid condensate into the reservoir, after which the well is then put back in production. This approach is repeated several times in the life of the well (*gas cycling*). Another method involves the injection of both nitrogen and methane into the reservoir which develops a miscible displacement.



# Retrograde Condensation

Retrograde condensation is the formation of liquid hydrocarbons in a gas reservoir as the pressure in the reservoir decreases below the critical point pressure during production. It is called *retrograde* because the gas condenses into a liquid under isothermal conditions instead of expanding or vaporizing when pressure is decreased.

The initial producing gas-oil ratio for a retrograde gas lies above 3300 scf/STB although ratios of as high as

150,000 have occurred. Producing gas-oil ratios for a retrograde gas will increase after production begins when reservoir pressure decreases past the dew point pressure of the gas. Stock-tank liquid gravities range from 45 to 60° API and increase as reservoir pressure decreases beyond the dew point. The condensed liquid or condensate is typically lightly colored, brown, orange or water-white. The concentration of  $C_{7+}$  is usually less than 12–15 mole%.



# Reynolds Number

The Reynolds number,  $N_{Re}$ , is a dimensionless number that relates inertial and viscous forces. It is used in the friction factor correlation, to determine the resistance to flow by a pipe.

$$N_{Re} = \rho D U \mu$$

$D$  is the pipe diameter in meters or feet,  $U$  is the average fluid velocity in meters/second or feet/second and is equal to  $G/\rho$ ,  $\mu$  is the dynamic viscosity of the fluid in kilogram/meter-second or pounds/foot-hour,  $\rho$  is the density of liquid in kilograms/cubic meter or pounds/cubic foot.



# Rock Types

The earth is composed of three general rock types: (1) igneous, (2) sedimentary, and (3) metamorphic.

**Igneous** rocks are the original rocks of the earth and were solidified from the molten mixture of materials that made up the earth prior to its cooling. Igneous rocks are very complex assemblages of minerals. Usually such rocks are very dense and have very few pores (or voids) which can accumulate or pass any type of fluid.

**Sedimentary** rocks are aggregates of particles broken away from other rock masses which are exposed at or near the earth's surface to weathering processes. These particles are then transported by water, wind, or ice (glaciers) motion to new locations where they assemble eventually into a new rock mass. The origin of the rock mass prior to action by the weathering process can be igneous rock, another sedimentary rock, or metamorphic rock (see next rock type). During the process of weathering and transportation (particularly by water) compounds are precipitated chemically from the original rock mass or from materials within the water itself. In lake or seawater environments organisms provide such compounds. As the particles are

deposited in slower moving waters, the chemical compounds provide a type of cement that ultimately binds the particles into a sedimentary rock mass. Sedimentary rock masses that are formed from water erosion and deposition by water in lake or ocean environments were originally laid down (deposited) in horizontal or near horizontal (deltas) layers.

**Metamorphic** rocks are formed from either igneous, sedimentary, or possibly other metamorphic rock masses. These original rock masses are subjected to heat, pressure, or chemically active gases or liquids which significantly alter the original rock to a new crystalline form.

In general, approximately 75% of the land surface area is composed of sedimentary rocks. Most of the remaining land area is composed of igneous rock, with metamorphic rocks being a rather small percentage of the earth's surface-exposed rock. If the outer 10 miles of thickness of the earth is considered, it is estimated that 95% of this volume of rocks (including those exposed at the surface) are igneous rocks. Igneous rocks are the original rocks of the earth and are, therefore, the ancestors of all other rock types.





# SARA Analysis

The SARA (saturates-aromatics-resins-asphaltenes) analysis is one of several means of fractionating crude oil and similar feedstocks. The method is a combination of solvent separation and separation using an adsorbent.

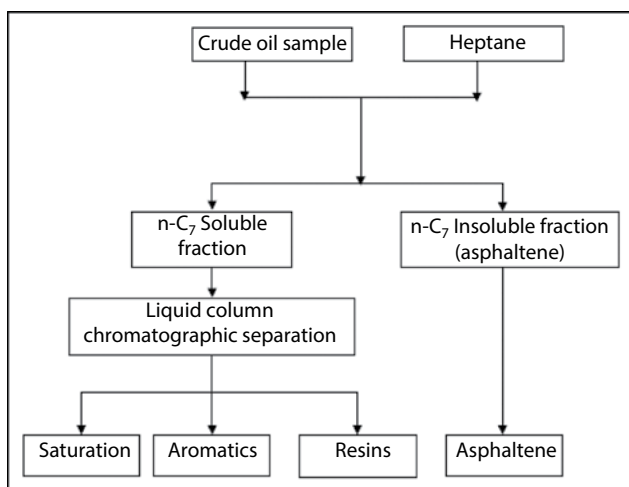

**Figure** Schematic of the SARA Analytical Method.



## Saturated Steam

Water can exist in the form of a solid (ice), as a liquid (water), or as a gas (loosely called steam). Steamflood processes are concerned with the liquid and gas phases, and the change from one phase to the other. The phase change region, in which water coexists as liquid and gas, is where our interest lies when considering steam for use in the oil field.

The term steam is an imprecise designation because it refers to a water liquid/gas system that can exist from 0 °C (32 °F) to any higher temperature; from 0.1 psia to any higher pressure; and from nearly all liquid to 100% gas. Steam quality,  $f_s$ , refers to the phase change region of liquid to gas and is defined as:

$$f_s = \frac{m_v}{m_v + m_l}$$

In this equation,  $m_v$  is the amount of water in the vapor phase and  $m_l$  is the amount of water in the liquid phase.

Heat capacity is expressed in units of Btu/(lbm-°F). A “Btu” is defined as the amount of heat required to raise 1 lbm of water from 60 to 61 °F. All liquids and solids are compared

to pure water, which has the highest heat capacity of any substance at 1 Btu/(lbm-°F). By calculating a ratio of the heat capacity of water divided by that of another substance, a convenient fraction called “specific heat” is obtained. Notice that petroleum has a specific heat of 0.5, or half that of water, and sandstone is only 20% of water on a per pound basis. No other liquid or gas carries as much heat per pound as water. Also, the temperature range at which this high heat carrying performance is achieved, 34 to 700 °F, is ideal for many processes, including steam flooding.

Enthalpy is a useful property defined by an arbitrary combination of other properties and is not a true form of energy. Although the absolute value of enthalpy may be of little value, changes in enthalpy are extremely useful, however, and are the basis for steamflood energy calculations. The total enthalpy held by each pound of liquid water at any temperature is called sensible heat,  $h_f$ . The heat input, which produces a change of state from liquid to gas without a change of temperature (*latent heat of evaporation*) and is shown by  $h_{fv}$ . The total heat,  $h_v$ , in each pound of 100% quality or saturated steam is the sum of these two,  $h_v = h_f + h_{fv}$ .



# Saturation

Saturation is the fraction, or percent, of the pore volume occupied by a particular fluid (oil, gas, or water): Thus:

Fluid saturation = (total volume of fluid)/pore volume

Applying the above mathematical concept of saturation to each reservoir fluid gives:

$$S_o = (\text{volume of oil})/\text{pore volume}$$

$$S_g = (\text{volume of gas})/\text{pore volume}$$

$$S_w = (\text{volume of water})/\text{pore volume}$$

In these equations,  $S_o$  is the oil saturation,  $S_g$  is the gas saturation, and  $S_w$  is the water saturation. Thus, all saturation values are based on *pore volume* and not on the gross reservoir volume. The saturation of each individual phase ranges between zero to 100. By definition, the sum of the saturations is 100, therefore:

$$S_g + S_o + S_w = 1.0$$

The fluids in most reservoirs are believed to have reached a state of equilibrium and, therefore, will have become separated according to the density, i.e., oil overlain by gas and underlain by water. In addition to the bottom (or edge) water, there will be connate water distributed throughout the oil and gas zones. The water in these zones will have been reduced to some irreducible minimum. The forces retaining the water in the oil and gas zones are referred to as *capillary forces* because they are important only in pore spaces of capillary size.

Connate (interstitial) water saturation ( $S_{wc}$ ) is important primarily because it reduces the amount of space available between oil and gas. It is generally not uniformly distributed throughout the reservoir but varies with permeability, lithology, and height above the free water table.

## Critical oil saturation, $S_{oc}$

For the oil phase to flow, the saturation of the oil must exceed a certain value, which is termed critical oil saturation. At this

particular saturation, the oil remains in the pores and, for all practical purposes, will not flow.

## Residual oil saturation, $S_{or}$

During the displacing process of the crude oil system from the porous media by water or gas injection (or encroachment), there will be some remaining oil left that is quantitatively characterized by a saturation value that is larger than the *critical oil saturation*. This saturation value is called the *residual oil saturation* ( $S_{or}$ ) which is usually associated with the non-wetting phase when it is being displaced by a wetting phase.

## Movable oil saturation, $S_{om}$

Movable oil saturation ( $S_{om}$ ) is another saturation of interest and is the fraction of pore volume occupied by movable oil as expressed by the following equation:

$$S_{om} = 1 - S_{wc} - S_{oc}$$

where  $S_{wc}$  is the connate water saturation and  $S_{oc}$  is the critical oil saturation.

## Critical gas saturation, $S_{gc}$

As the reservoir pressure declines below the bubble-point pressure, gas evolves from the oil phase and consequently the saturation of the gas increases as the reservoir pressure declines. The gas phase remains immobile until its saturation exceeds a certain saturation, called *critical gas saturation*, above which gas begins to move.

## Critical water saturation, $S_{wc}$

The critical water saturation, connate water saturation, and irreducible water saturation are extensively used interchangeably to define the maximum water saturation at which the water phase will remain immobile.



# Sediments, Reservoirs, and Deposits

Sediments and sedimentary rocks are an important, but unfortunately an often-ignored, aspect of petroleum geology and hence petroleum recovery operations. Knowledge of the geology and mineralogy of a reservoir or deposit leads to deriving the means by which to find and penetrate the reservoir (or deposit), which would be sorely lacking and, most likely, cause problems during recovery. In addition, such knowledge is advantageous when *in situ* upgrading is considered as a process option during recovery. The minerals might well (hopefully) exhibit beneficial catalytic activity on the *in situ* upgrading process or, on the other hand, the minerals might have an adverse effect on the process chemistry and physics.

Typically, the majority (in excess of 90%) of all sedimentary rocks consist of (1) sandstone rocks, which consist of sand-sized fragments and are important when dealing with conventional petroleum reservoirs, (2) mudrocks, which consist of silt- and clay- sized fragments and are important when dealing with crude oil and natural gas from tight formations such as shale formations, and carbonate rocks which consist of calcite ( $\text{CaCO}_3$ ), aragonite ( $\text{CaCO}_3$ ), or dolomite ( $\text{CaCO}_3, \text{MgCO}_3$ ). The carbonate minerals are typically formed as a result of biological and physical processes, including precipitation from marine and freshwater environments. Of these minerals, the mudrocks are most abundant, making up about 65% of all sedimentary rocks. Sandstones make up 20 to 25% of all sedimentary rocks, and

carbonate rocks account for about 10 to 15% of all carbonate rocks.

The depth of a sediment is critical for a number of important properties. The deeper the formation, the more likely it will be compacted as the grains are finer and consolidated. Secondary cementation processes are usually responsible for rock consolidation as cementing materials have percolated through the rock over geologic time. Shallow reservoirs are likely to consist of coarser materials and are likely to be unconsolidated.

There is gradation between deep highly consolidated rocks at, e.g., 20,000 feet depth and highly unconsolidated rocks at 1,000 feet and various grain sizes (Table) are likely to be encountered in shallow formations, to grain sizes on the lower right, which are likely to be encountered in very deep formations. Depth also implies a gradation in *permeability* and *porosity*. Deeper reservoirs are far less permeable than shallow reservoirs. At 20,000 feet, permeability of 0.1 mD or even less is quite common, whereas at 3,000 feet, permeability may exceed 10,000 mD. At 10,000 feet, where some of the most prolific reservoirs in the world are found, permeability is likely to fluctuate between 10 and 100 mD. While porosity does not have such large fluctuations, it is still likely to reflect depth. This applies generally to sandstone reservoirs. Carbonate reservoirs, in some areas, may follow similar trends; but elsewhere they may exhibit unique features, where very large porosities may be found in reservoirs with very small permeability.

**Table 1** Types of facies.

<b>I. Terrigenous or Non-Marine Facies</b>	<b>II. Near Shore Facies</b>
Alluvial Fan Floodplain Lacustrine (lakes) Fluvial (streams) Eolian (wind deposited, sand dunes) Swamp Glacial	Deltaic Estuarine Bay or Lagoon Marsh Intertidal Beach or Barrier Island Glacial Marine
<b>III. Shallow Marine Facies (depth &lt;650 feet)</b>	<b>IV. Deep Marine Facies (depth &gt;650 feet)</b>
Continental Shelf Carbonate bank and shelf Forearc basin Evaporite basin	Submarine canyon Submarine fan Back arc basin Deep ocean basin

**Table 2** Characteristics of sediments based on grain size and shape.

Particle-type	Size range, mm	Sediment-type	Rock-type
Boulder	>256	Gravel	Conglomerate or Breccia
Cobble	64-256		
Pebble	4-64		
Granule	2-4		
Very Coarse Sand	1-2	Sand	Sandstone
Coarse Sand	0.5-1		
Medium Sand	0.25-0.5		
Fine Sand	0.125-0.25		
Very Fine Sand	0.0625-0.125		
Coarse Silt	0.031-0.625	Silt	Siltstone
Medium Silt	0.016-0.031		
Fine Silt	0.008-0.016		
Very Fine Silt	0.004-0.008		
Clay	<0.004	Clay	Claystone, Mudstone, Shale



## Separators – Gas-Oil Separation

In many instances pressure relief at the wellhead will cause a natural separation of gas from oil (using a conventional closed tank, where gravity separates the gas hydrocarbons from the higher boiling crude oil). In some cases, however, a multi-stage gas-oil separation process is needed to separate the gas stream from the crude oil. These *gas-oil separators* are commonly closed cylindrical shells, horizontally mounted with inlets at one end, an outlet at the top for removal of gas, and an outlet at the bottom for removal of oil but differ in their purpose and efficiency (Table). Separation is accomplished by alternately heating and cooling (by compression) the flow stream through multiple steps; some water and condensate, if present, will also be extracted as the process proceeds.

At some stage of the processing, the gas flow is directed to a unit that contains a series of filter tubes. As the velocity of the stream reduces in the unit, primary separation of

remaining contaminants occurs due to gravity. Separation of smaller particles occurs as gas flows through the tubes, where they combine into larger particles which flow to the lower section of the unit. Further, as the gas stream continues through the series of tubes, a centrifugal force is generated which further removes any remaining water and small solid particulate matter.

**Table** Types of liquid-gas separators.

Technology	Droplet size removed
Gravity separator	Down to 300 $\mu\text{m}$
Centrifugal separator	Down to 8–10 $\mu\text{m}$
Mist eliminator pad	Down to 10 $\mu\text{m}$
Vane separator	Down to 10 $\mu\text{m}$
High efficiency L/G coalescer	Down to 0.1 $\mu\text{m}$



# Shale Gas Formation

**Table** Shale Gas Formations in the United States and Canada.

<b>Formation</b>	<b>Period</b>	<b>Location</b>
Antrim Shale	Late Devonian	Michigan Basin, Michigan
Baxter Shale	Late Cretaceous	Vermillion Basin, Colorado, Wyoming
Barnett Shale	Mississippian	Fort Worth and Permian basins, Texas
Bend Shale	Pennsylvanian	Palo Duro Basin, Texas
Cane Creek Shale	Pennsylvanian	Paradox Basin, Utah
Caney Shale	Mississippian	Arkoma Basin, Oklahoma
Chattanooga Shale	Late Devonian	Alabama, Arkansas, Kentucky, Tennessee
Chimney Rock Shale	Pennsylvanian	Paradox Basin, Colorado, Utah
Cleveland Shale	Devonian	Eastern Kentucky
Clinton Shale	Early Silurian	Eastern Kentucky
Cody Shale	Cretaceous	Oklahoma, Texas
Colorado Shale	Cretaceous	Central Alberta, Saskatchewan
Conasauga Shale	Middle Cambrian	Black Warrior Basin, Alabama
Dunkirk Shale	Upper Devonian	Western New York
Duvernay Shale	Late Devonian	West central Alberta
Eagle Ford Shale	Late Cretaceous	Maverick Basin, Texas
Ellsworth Shale	Late Devonian	Michigan Basin, Michigan
Excello Shale	Pennsylvanian	Kansas, Oklahoma
Exshaw Shale	Devonian-Mississippian	Alberta, northeast British Columbia
Fayetteville Shale	Mississippian	Arkoma Basin, Arkansas
Fernie Shale	Jurassic	West central Alberta, northeast British Columbia
Floyd/Neal Shale	Late Mississippian	Black Warrior Basin, Alabama, Mississippi
Frederick Brook Shale	Mississippian	New Brunswick, Nova Scotia
Gammon Shale	Late Cretaceous	Williston Basin, Montana
Gordondale Shale	Early Jurassic	Northeast British Columbia
Gothic Shale	Pennsylvanian	Paradox Basin, Colorado, Utah

(Continued)

Table Cont.

Formation	Period	Location
Green River Shale	Eocene	Colorado, Utah
Haynesville/Bossier Shale	Late Jurassic	Louisiana, east Texas
Horn River Shale	Middle Devonian	Northeast British Columbia
Horton Bluff Shale	Early Mississippian	Nova Scotia
Hovenweep Shale	Pennsylvanian	Paradox Basin, Colorado, Utah
Huron Shale	Devonian	East Kentucky, Ohio, Virginia, West Virginia
Klua/Evie Shale	Middle Devonian	Northeast British Columbia
Lewis Shale	Late Cretaceous	Colorado, New Mexico
Mancos Shale	Cretaceous	San Juan Basin, New Mexico, Uinta Basin, Utah
Manning Canyon Shale	Mississippian	Central Utah
Marcellus Shale	Devonian	New York, Ohio, Pennsylvania, West Virginia
McClure Shale	Miocene	San Joaquin Basin, California
Monterey Shale	Miocene	Santa Maria Basin, California
Montney-Doig Shale	Triassic	Alberta, northeast British Columbia
Moorefield Shale	Mississippian	Arkoma Basin, Arkansas
Mowry Shale	Cretaceous	Bighorn and Powder River basins, Wyoming
Muskwa Shale	Late Devonian	Northeast British Columbia
New Albany Shale	Devonian-Mississippian	Illinois Basin, Illinois, Indiana
Niobrara Shale	Late Cretaceous	Denver Basin, Colorado
Nordegg/Gordondale Shale	Late Jurassic	Alberta, northeast British Columbia
Ohio Shale	Devonian	East Kentucky, Ohio, West Virginia
Pearsall Shale	Cretaceous	Maverick Basin, Texas
Percha Shale	Devonian-Mississippian	West Texas
Pierre Shale	Cretaceous	Raton Basin, Colorado
Poker Chip Shale	Jurassic	West central Alberta, northeast British Columbia
Queenston Shale	Ordovician	New York
Rhinestreet Shale	Devonian	Appalachian Basin
Second White Speckled Shale	Late Cretaceous	Southern Alberta
Sunbury Shale	Mississippian	Appalachian Basin
Utica Shale	Ordovician	New York, Ohio, Pennsylvania, West Virginia, Quebec
Wilrich/Buckinghorse/ Garbutt/ Moosebar Shale	Early Cretaceous	West central Alberta, northeast British Columbia
Woodford Shale	Devonian-Mississippian	Oklahoma, Texas

## Shale Gas Reservoirs – Variation in Shale Properties

Shale gas is found in shale plays, which are shale formations containing significant accumulations of natural gas and which share similar (n = but not entirely the same) geologic and geographic properties. In addition, to shale gas, other types of unconventional reservoirs include tight gas (low-porosity sandstones and carbonate reservoirs) and coal bed methane (CBM – gas produced from coal seams).

Conventional gas reservoirs are created when natural gas migrates toward the Earth's surface from an organic-rich source formation into highly permeable reservoir rock, where it is trapped by an overlying layer of impermeable

rock. In contrast, shale gas resources form within the organic-rich shale source rock. The low permeability of the shale greatly inhibits the gas from migrating to more permeable reservoir rocks. Without horizontal drilling and hydraulic fracturing, shale gas production would not be economically feasible because the natural gas would not flow from the formation at high enough rates to justify the cost of drilling. However, not all shale formations are the same and, in addition to the variations in properties of the gas, there are also variations in properties between the various shale formations (Table).

**Table** Variation in shale properties from known reservoirs.

Sample Group	Estimated <i>insitu</i> stress [MPa]	Density [g/cc]	QFP [%]	Carbonate [%]	Clay [%]	Kerogen [%]	Porosity [%]
Barnett-1	Sv: 65	2.39–2.47	50–52	0–3	36–39	9–11	4–9
Barnett-2	Pp: 30 $\sigma_{\text{eff}}$ : 35	2.63–2.67	31–53	37–60	3–7	2–3	1–2
Haynesville-1	Sv: 85	2.49–2.51	32–35	20–22	36–39	8–8	6–6
Haynesville-2	Pp: 60-70 $\sigma_{\text{eff}}$ : 15-25	2.60–2.62	23–24	49–53	20–22	4–4	3–4
Eagle Ford-1	Sv: 90	2.43–2.46	22–29	46–54	12–21	9–11	0–3
Eagle Ford-2	Pp: 65 $\sigma_{\text{eff}}$ : 25	2.46–2.54	11–18	63–78	6–14	4–5	3–5
Fort St. John	Sv: 25-30 Pp: 10-12 $\sigma_{\text{eff}}$ : 13-20	2.57–2.60	54–60	3–5	32–39	4–5	5–6

QFP: refers to quartz, feldspar, plagioclase, and pyrite component.



## Shale Gas – Variations in Composition

Shale gas is natural gas that is trapped within shale formations. Shale gas has become an increasingly important source of natural gas in the United States since the start of this century, and interest has spread to potential gas shales in the rest of the world. However, all shale gas is not the

same and gas processing requirements for shale gas can vary from area to area. As a result, shale gas processors must be concerned about elevated ethane and nitrogen levels across a field. Other concerns are the increased requirements of urban gas processing.

Composition of selected unprocessed shale gas samples.

Component	(Volume %)			
	Marcellus	Appalachian	Haynesville	Eagle Ford
Methane	97.131	79.084	96.323	74.595
Ethane	2.441	17.705	1.084	13.824
Propane	0.095	0.566	0.205	5.425
C4+	0.014	0.064	0.203	4.462
Hexanes+	0.001	0.000	0.061	0.478
Carbon Dioxide	0.040	0.073	1.816	1.536
Nitrogen	0.279	2.537	0.369	0.157
Total Inerts (CO <sub>2</sub> + N <sub>2</sub> )	0.318	2.609	2.184	1.693
Total	100.0	100.0	100.1	100.5
HHV (BTU/SCF)	1,031.6	1,133.2	1,009.8	1,307.1
Hydrocarbon Dew Point (°F)	-96.8	-41.3	9.7	119.6
Wobbe Number (BTU/SCF)	1,367.1	1,367.1	1,320.1	1,490.0





## Shale Oil (Kerogen-Derived Oil) – Variation in Properties

There has been a tendency to refer to the crude oil contained in shale reservoirs and in tight reservoirs as *shale oil*. This terminology is incorrect insofar as it is confusing and the use of such terminology should be discouraged as illogical since shale oil has (for decades, even centuries) been the name given to the distillate produced from oil shale by thermal decomposition. There has been the recent (and logical) suggestion that shale oil can be referred to as *kerogen oil* or *kerogen-derived oil*.

Oil shale – a shale formation containing kerogen – is found at shallow depths, from surface outcrops to 3,000 feet deep. It is a very low-permeability sedimentary rock that contains a large proportion of kerogen, a mixture of solid organic compounds. In kerogen-containing shale reservoirs, conversion of the kerogen into liquid oil (shale oil,

kerogen oil) has not taken place because the high temperatures required have not been experienced. Oil shale consists of minerals of variable composition mixed with organic matter commonly occurring finely dispersed in the matrix or in thin laminae. To allow an appreciation of their complex behavior especially at high temperature, it is useful to consider an oil shale as a three-phase material: (1) minerals, (2) kerogen, and (3) pore fill and the bulk mechanical properties strongly depend on the volume fractions of these phases. Commonly, the parameter reported is the oil yield given in gallons per ton (GPT, 1gallon = 4.2 liters) determined by the standardized Fischer assay technique (heating 100 g of crushed rock to 500 °C, 930 °F) and there are variations in the properties of the oil from various kerogen-containing shales (Table).

**Table** Properties of shale oil.

Location	Sp gr (API)	Elemental analysis, % w/w					Analysis of distillate <350 °C % w/w		
		C	H	O	N	S	Saturates	Olefins	Aromatics
Colorado, USA	0.943	84.90	11.50	0.80	2.19	0.61	27	44	29
Kukersite, Estonia	1.010	82.85	9.20	6.79	0.30	0.86	22	25	53
Stuart, Australia		82.70	12.40	3.34	0.91	0.65			
Rundle, Australia	0.636	79.50	11.50	7.60	0.99	0.41	48	2	50
Irati, Brazil	0.919	84.30	12.00	1.96	1.06	0.68	23	41	36
Maoming, China	0.903	84.82	11.40	2.20	1.10	0.48	55	20	25
Fushun, China	0.912	85.39	12.09	0.71	1.27	0.54	38	37	25



## Shale Plays – Properties

In the current context, a shale play is a shale formation that contains natural gas or crude oil. Shale is characterized by breaks along thin laminae or parallel layering or bedding less than one centimeter in thickness (fissility).

Each shale formation is a fine-grained, clastic sedimentary rock composed of a mix of flakes of clay minerals and small

fragments (silt-sized particles) of other minerals, especially quartz ( $\text{SiO}_2$ ) and calcite ( $\text{CaCO}_3$ ). The ratio of clay to other minerals is variable and therefore, the properties are variable (Table).

**Table** Properties of various shale plays.

Play	Antrim	Barnett	Eagle Ford	Marcellus	New Albany
Depth, feet	600–2,000	6,500–8,500	4,000–13,500	2,000–9,500	500–2,000
Thickness, feet	60–220	200–300			50–100
Total organic carbon, % w/w	5	10	7	15	
Porosity, % v/v	8	14	14	15	10
Clay, % w/w		20–40	15–35	30–50	
Quartz + calcite, % w/w		40–50	50–80	40–60	
Areal extent, square miles		22,000	15,000	60,000	
Resource size, tcf		25–250	10–100	50–500	



# SI – International System of Units

The name *Système International d'Unités* (International System of Units), and the abbreviation SI, were established by the 11th General Conference on Weights and Measures (CGPM) in 1960.

The base quantities used in the SI are length, mass, time, electric current, thermodynamic temperature, amount of substance, and luminous intensity. The base quantities are by convention assumed to be independent. The corresponding base units of the SI were chosen by the CGPM to be the metre, the kilogram, the second, the ampere, the kelvin, the mole, and the candela. The derived units of the SI are then formed as products of powers of the base units, according to the algebraic relations that define the corresponding derived quantities in terms of the base quantities. When the product of powers includes no numerical factor other than one, the derived units are called coherent derived units. Symbols

for quantities are generally single letters set in an italic font, although they may be qualified by further information in subscripts or superscripts or in brackets. Note that symbols for quantities are only *recommendations*, in contrast to symbols for units whose style and form is *mandatory*.

The value of a quantity is expressed as the product of a number and a unit, and the number multiplying the unit is the numerical value of the quantity expressed in that unit. The numerical value of a quantity depends on the choice of unit. Thus the value of a particular quantity is independent of the choice of unit, although the numerical value will be different for different units. The same value of a speed  $v = dx/dt$  of a particle might be given by either of the expressions  $v = 25 \text{ m/s} = 90 \text{ km/h}$ , where 25 is the numerical value of the speed in the unit metres per second, and 90 is the numerical value of the speed in the unit kilometers per hour.

## SI base units

Base quantity		SI base unit	
Name of base quantity	Symbol	Name of SI base unit	Symbol
Length	$l, x, r, \text{etc.}$	<u>metre</u>	m
Mass	$m$	<u>kilogram</u>	kg
time, duration	$t$	<u>second</u>	s
electric current	$I, i$	<u>ampere</u>	A
thermodynamic temperature	$T$	<u>kelvin</u>	K
amount of substance	$n$	<u>mole</u>	mol
luminous intensity	$I_v$	<u>candela</u>	cd

**Examples of coherent derived units in the SI expressed in terms of base units**

Derived quantity		SI coherent derived unit	
Name	Symbol	Name	Symbol
Area	$A$	square metre	$\text{m}^2$
volume	$V$	cubic metre	$\text{m}^3$
speed, velocity	$v$	metre per second	$\text{m s}^{-1}$
acceleration	$a$	metre per second squared	$\text{m s}^{-2}$
wavenumber	$\sigma$	reciprocal metre	$\text{m}^{-1}$
density, mass density	$\rho$	kilogram per cubic metre	$\text{kg m}^{-3}$
surface density	$\rho_A$	kilogram per square metre	$\text{kg m}^{-2}$
specific volume	$v$	cubic metre per kilogram	$\text{m}^3\text{kg}^{-1}$
current density	$j$	ampere per square metre	$\text{A m}^{-2}$
magnetic field strength	$H$	ampere per metre	$\text{A m}^{-1}$
amount concentration, concentration	$c$	mole per cubic metre	$\text{mol m}^{-3}$
mass concentration	$\rho, \gamma$	kilogram per cubic metre	$\text{kg m}^{-3}$
luminance	$L_v$	candela per square metre	$\text{cd m}^{-2}$
refractive index	$n$	(the number) one	1
relative permeability	$\mu_r$	(the number) one	1

**Coherent derived units in the SI with special names and symbols**

Derived quantity	SI coherent derived unit			
	Name	Symbol	Expressed in terms of other SI units	Expressed in terms of SI base units
plane angle	radian	rad	1	$\text{m m}^{-1}$
solid angle	steradian	sr	1	$\text{m}^2 \text{m}^{-2}$
frequency	hertz	Hz		$\text{s}^{-1}$
Force	newton	N		$\text{m kg s}^{-2}$
pressure, stress	pascal	Pa	$\text{N/m}^2$	$\text{m}^{-1} \text{kg s}^{-2}$
energy, work, amount of heat	joule	J	$\text{N m}$	$\text{m}^2 \text{kg s}^{-2}$
power, radiant flux	watt	W	$\text{J/s}$	$\text{m}^2 \text{kg s}^{-3}$
electric charge, amount of electricity	coulomb	C		$\text{s A}$
electric potential difference, electromotive force	volt	V	$\text{W/A}$	$\text{m}^2 \text{kg s}^{-3} \text{A}^{-1}$
capacitance	farad	F	$\text{C/V}$	$\text{m}^{-2} \text{kg}^{-1} \text{s}^4 \text{A}^2$
electric resistance	ohm	$\Omega$	$\text{V/A}$	$\text{m}^2 \text{kg s}^{-3} \text{A}^{-2}$
electric conductance	siemens	S	$\text{A/V}$	$\text{m}^{-2} \text{kg}^{-1} \text{s}^3 \text{A}^2$
magnetic flux	weber	Wb	$\text{V s}$	$\text{m}^2 \text{kg s}^{-2} \text{A}^{-1}$
magnetic flux density	tesla	T	$\text{Wb/m}^2$	$\text{kg s}^{-2} \text{A}^{-1}$
inductance	henry	H	$\text{Wb/A}$	$\text{m}^2 \text{kg s}^{-2} \text{A}^{-2}$
Celsius temperature	degree Celsius	$^{\circ}\text{C}$		K
luminous flux	lumen	lm	$\text{cd sr}$	cd
luminance	lux	lx	$\text{lm/m}^2$	$\text{m}^{-2} \text{cd}$
activity referred to a radionuclide	becquerel	Bq		$\text{s}^{-1}$
absorbed dose, specific energy (imparted), kerma	gray	Gy	$\text{J/kg}$	$\text{m}^2 \text{s}^{-2}$
dose equivalent, ambient dose equivalent, directional dose equivalent, personal dose equivalent	sievert	Sv	$\text{J/kg}$	$\text{m}^2 \text{s}^{-2}$
catalytic activity	katal	kat		$\text{s}^{-1} \text{mol}$

### Examples of SI coherent derived units whose names and symbols include SI coherent derived units with special names and symbols

		SI coherent derived unit	
Derived quantity	Name	Symbol	Expressed in terms of SI base units
dynamic viscosity	pascal second	Pa s	$\text{m}^{-1} \text{kg s}^{-1}$
moment of force	newton metre	N m	$\text{m}^2 \text{kg s}^{-2}$
surface tension	newton per metre	N/m	$\text{kg s}^{-2}$
angular velocity	radian per second	rad/s	$\text{m m}^{-1} \text{s}^{-1} = \text{s}^{-1}$
angular acceleration	radian per second squared	rad/s <sup>2</sup>	$\text{m m}^{-1} \text{s}^{-2} = \text{s}^{-2}$
heat flux density, irradiance	watt per square metre	W/m <sup>2</sup>	$\text{kg s}^{-3}$
heat capacity, entropy	joule per kelvin	J/K	$\text{m}^2 \text{kg s}^{-2} \text{K}^{-1}$
specific heat capacity, specific entropy	joule per kilogram kelvin	J/(kg K)	$\text{m}^2 \text{s}^{-2} \text{K}^{-1}$
specific energy	joule per kilogram	J/kg	$\text{m}^2 \text{s}^{-2}$
thermal conductivity	watt per metre kelvin	W/(m K)	$\text{m kg s}^{-3} \text{K}^{-1}$
energy density	joule per cubic metre	J/m <sup>3</sup>	$\text{m}^{-1} \text{kg s}^{-2}$
electric field strength	volt per metre	V/m	$\text{m kg s}^{-3} \text{A}^{-1}$
electric charge density	coulomb per cubic metre	C/m <sup>3</sup>	$\text{m}^{-3} \text{s A}$
surface charge density	coulomb per square metre	C/m <sup>2</sup>	$\text{m}^{-2} \text{s A}$
electric flux density, electric displacement	coulomb per square metre	C/m <sup>2</sup>	$\text{m}^{-2} \text{s A}$
permittivity	farad per metre	F/m	$\text{m}^{-3} \text{kg}^{-1} \text{s}^4 \text{A}^2$
permeability	henry per metre	H/m	$\text{m kg s}^{-2} \text{A}^{-2}$
molar energy	joule per mole	J/mol	$\text{m}^2 \text{kg s}^{-2} \text{mol}^{-1}$
molar entropy, molar heat capacity	joule per mole kelvin	J/(mol K)	$\text{m}^2 \text{kg s}^{-2} \text{K}^{-1} \text{mol}^{-1}$
exposure (x- and $\gamma$ -rays)	coulomb per kilogram	C/kg	$\text{kg}^{-1} \text{s A}$
absorbed dose rate	gray per second	Gy/s	$\text{m}^2 \text{s}^{-3}$
radiant intensity	watt per steradian	W/sr	$\text{m}^4 \text{m}^{-2} \text{kg s}^{-3} = \text{m}^2 \text{kg s}^{-3}$
radiance	watt per square metre steradian	W/(m <sup>2</sup> sr)	$\text{m}^2 \text{m}^{-2} \text{kg s}^{-3} = \text{kg s}^{-3}$
catalytic activity concentration	katal per cubic metre	kat/m <sup>3</sup>	$\text{m}^{-3} \text{s}^{-1} \text{mol}$

### Non-SI units accepted for use with the International System of Units

Quantity	Name of unit	Symbol for unit	Value in SI units
time, duration	minute	min	1 min = 60 s
	hour	h	1 h = 60 min = 3 600 s
	day	d	1 d = 24 h = 86 400 s
plane angle	degree	°	1° = ( $\pi/180$ ) rad
	minute	'	1' = (1/60)° = ( $\pi/10\,800$ ) rad
	second	''	1'' = (1/60)' = ( $\pi/648\,000$ ) rad
area	hectare	ha	1 ha = 1 hm <sup>2</sup> = 10 <sup>4</sup> m <sup>2</sup>
volume	litre	L, l	1 L = 1 dm <sup>3</sup> = 10 <sup>-3</sup> m <sup>3</sup>
mass	tonne	t	1 t = 10 <sup>3</sup> kg

**Non-SI units whose values in SI units must be obtained experimentally**

Quantity	Name of unit	Symbol for unit	Value in SI units
<b>Units accepted for use with the SI</b>			
energy	electronvolt	eV	1 eV = 1.602 176 53(14)×10 <sup>-19</sup> J
mass	dalton	Da	1 Da = 1.660 538 86(28)×10 <sup>-27</sup> kg
	unified atomic mass unit	u	1 u = 1 Da
length	astronomical unit	ua	1 ua = 1.495 978 706 91(6)×10 <sup>11</sup> m
<b>Natural units (n.u.)</b>			
speed, velocity	natural unit of speed (speed of light in vacuum)	$c_0$	299 792 458 m s <sup>-1</sup>
action	natural unit of action (reduced Planck constant)	$\hbar$	1.054 571 68(18)×10 <sup>-34</sup> Js
mass	natural unit of mass (electron mass)	$m_e$	9.109 382 6(16)×10 <sup>-31</sup> kg
time, duration	natural unit of time	$\hbar/(m_e c_0^2)$	1.288 088 667 7(86)×10 <sup>-21</sup> s
<b>Atomic units (a.u.)</b>			
charge	atomic unit of charge, (elementary charge)	$e$	1.602 176 53(14)×10 <sup>-19</sup> C
mass	atomic unit of mass, (electron mass)	$m_e$	9.109 382 6(16)×10 <sup>-31</sup> kg
action	atomic unit of action, (reduced Planck constant)	$\hbar$	1.054 571 68(18)×10 <sup>-34</sup> Js
length	atomic unit of length, bohr (Bohr radius)	$a_0$	0.529 177 210 8(18)×10 <sup>-10</sup> m
energy	atomic unit of energy, hartree (Hartree energy)	$E_h$	4.359 744 17(75)×10 <sup>-18</sup> J
time, duration	atomic unit of tim	$\hbar/E_h$	2.418 884 326 505(16)×10 <sup>-17</sup> s

**Other non-SI units**

Quantity	Name of unit	Symbol for unit	Value in SI units
pressure	bar	bar	1 bar = 0.1 MPa = 10 <sup>5</sup> Pa
	millimetre of mercury	mmHg	1 mmHg ≈ 133.322 Pa
length	ångström	Å	1 Å = 0.1 nm = 10 <sup>-10</sup> m
distance	nautical mile	M	1 M = 1852 m
area	barn	b	1 b = 100 fm <sup>2</sup> = 10 <sup>-28</sup> m <sup>2</sup>
speed, velocity	knot	kn	1 kn = (1852/3600) m s <sup>-1</sup>
logarithmic ratio quantities	neper	Np	
	bel	B	
	decibel	dB	

**Non-SI units associated with the CGS system of units**

Quantity	Name of unit	Symbol for unit	Value in SI units
energy	erg	erg	1 erg = 10 <sup>-7</sup> J
force	dyne	dyn	1 dyn = 10 <sup>-5</sup> N
dynamic viscosity	poise	P	1 P = 1 dyn s cm <sup>-2</sup> = 0.1 Pa s
kinematic viscosity	stokes	St	1 St = 1 cm <sup>2</sup> s <sup>-1</sup> = 10 <sup>-4</sup> m <sup>2</sup> s <sup>-1</sup>
luminance	stilb	sb	1 sb = 1 cd cm <sup>-2</sup> = 10 <sup>4</sup> cd m <sup>-2</sup>
illuminance	phot	ph	1 ph = 1 cd sr cm <sup>-2</sup> = 10 <sup>4</sup> lx
acceleration	gal	Gal	1 Gal = 1 cm s <sup>-2</sup> = 10 <sup>-2</sup> m s <sup>-2</sup>
magnetic flux	maxwell	Mx	1 Mx = 1 G cm <sup>2</sup> = 10 <sup>-8</sup> Wb
magnetic flux density	gauss	G	1 G = 1 Mx cm <sup>-2</sup> = 10 <sup>-4</sup> T
magnetic field	oersted	Oe	1 Oe $\hat{=}$ (10 <sup>3</sup> /4 $\pi$ ) A m <sup>-1</sup>



**SI prefixes**

Factor	Name	Symbol	Factor	Name	Symbol
$10^1$	deca	da	$10^{-1}$	deci	d
$10^2$	hecto	h	$10^{-2}$	centi	c
$10^3$	kilo	k	$10^{-3}$	milli	m
$10^6$	mega	M	$10^{-6}$	micro	$\mu$
$10^9$	giga	G	$10^{-9}$	nano	n
$10^{12}$	tera	T	$10^{-12}$	pico	p
$10^{15}$	peta	P	$10^{-15}$	femto	f
$10^{18}$	exa	E	$10^{-18}$	atto	a
$10^{21}$	zetta	Z	$10^{-21}$	zepto	z
$10^{24}$	yotta	Y	$10^{-24}$	yocto	y

Names and symbols for decimal multiples and submultiples of the unit of mass are formed by attaching prefix names to the unit name 'gram', and prefix symbols to the unit symbol 'g'.

These SI prefixes refer strictly to powers of 10. They should not be used to indicate powers of 2 (for example, one kilobit represents 1000 bits and not 1024 bits). The names and symbols for the prefixes corresponding to  $2^{10}$ ,  $2^{20}$ ,  $2^{30}$ ,  $2^{40}$ ,  $2^{50}$ , and  $2^{60}$  are, respectively: kibi, Ki; mebi, Mi; gibi, Gi; tebi, Ti; pebi, Pi; and exbi, Ei. Thus, for example, one kibibyte would be written: 1 KiB =  $2^{10}$  B = 1024 B, where B denotes a byte. Although these prefixes are not part of the SI, they should be used in the field of information technology to avoid the incorrect usage of the SI prefixes.



# Solubility Parameter

The Hildebrand solubility parameter ( $\delta$ ) provides a numerical estimate of the degree of interaction between materials, and can be a good indication of solubility, particularly for non-polar materials. Materials with similar values of  $\delta$  are likely to be miscible. The Hildebrand solubility parameter is the square root of the cohesive energy density:

$$\delta = \sqrt{((\Delta H_v - RT)/V_m)}$$

The solubility parameter provides useful predictions for non-polar and slightly polar systems without hydrogen bonding. It has found particular use in solute/solvent interactions, where it provides useful predictions of solubility. More complicated, 3-dimensional solubility parameters, such as *Hansen solubility parameter* can be used for polar molecules.

The solubility parameter (Table) is a measure of the ability of the compound to act as a solvent or non-solvent as well as a measure of the intermolecular and intramolecular forces between the solvent molecule and between the solvent and solute molecules (Barton, 1991). The solubility parameter is also a major parameter in certain petroleum products, especially in material such as residua and asphalt (Redelius, 2000, 2004).

The most prevalent thermodynamic approach to describing asphaltene solubility has been the application of the solubility parameter or the concept of cohesive energy density. The application of solubility parameter data to correlate asphaltene precipitation, and, hence, crude oil-solvent interaction, has been used on prior occasions (Mitchell and Speight, 1973; Speight, 2014). The solubility parameters of asphaltene constituents can be estimated from the properties of the solvent used for separation (Long and Speight, 1989) or be measured by the titration method (Andersen and Speight, 1992) or even from the atomic hydrogen-carbon ratio (Figure 7.3).

The solubility parameter difference that results in a phase separation of two materials, such as asphaltene constituents

in a solvent, can be estimated using the Scatchard-Hildebrand Equation:

$$\ln a_a = \ln x_a + M_a / \{RT\rho_a [\Phi_s^2(\delta_s - \delta_a)^2]\}$$

In the equation,  $a_a$  is the activity of the solute  $a$ ,  $x_a$  is the mole fraction solubility of  $a$ ,  $M_a$  is the molecular weight of  $a$ ,  $\rho_a$  is the density of  $a$ ,  $\Phi_s$  is the volume fraction of solvent, and  $(\delta_s - \delta_a)$  is the difference between the solubility parameters of the solute  $a$  and the solvent  $s$ . Assuming that the activity of the asphaltene constituents  $a_a$  is 1 (solid asphaltene constituents in equilibrium with dissolved asphaltene constituents) and the volume fraction of an excess of solvent is

**Table** Hansen Solubility Parameters for Selected Hydrocarbons.

Compound	dD	dP	dH
Toluene	18.0	1.4	2.0
cyclopentane	16.4	0.0	1.8
cyclohexane	16.8	0.0	0.2
o-xylene	17.8	1.0	3.1
trans-decalin	18.0	0.0	0.6
p-diethylbenzene	18.0	0.0	0.6
mesitylene	18.0	0.0	0.6
benzene	18.4	0.0	2.0
cis-decalin	18.8	0.0	0.0
naphthalene	19.2	2.0	5.9
tetrahydronaphthalene	19.6	2.0	2.9
1-methylnaphthalene	20.6	0.8	4.7
biphenyl	21.4	1.0	2.0

Key:

dD: the energy from dispersion forces between molecules.

dP: the energy from dipolar intermolecular forces between molecules.

dH: the energy from bonds between molecules.

essentially 1, the equation can be rearranged into a form that can be used to gain insight into the solubility of asphaltene constituents:

$$\ln x_a = -M_a/RT\Delta_a[(\delta_s - \delta_a)^2]$$

Assuming a density for asphaltene constituents of 1.28 g/cc and a molecular weight of 1,000 g/mole, the solubility of asphaltene constituents as a function of the differences between solubility parameters of the asphaltene constituents and precipitating solvent can be calculated. Thus, the solubility of asphaltene constituents can be shown to decrease as the difference between solubility parameters increases, with the limit of solubility attained at a difference of (approximately) 3. Thus, if the asphaltene constituents are part of a polarity and molecular weight

continuum in a crude oil, their precipitation is not as straightforward as it would be for a single species with a single solubility parameter, rather than a range of solubility parameters.

Incompatibility phenomena can be explained by the use of the solubility parameter for asphaltene constituents and other petroleum fractions. As an extension of this concept, there is sufficient data to draw an approximate correlation between hydrogen-to-carbon atomic ratio and the solubility parameter,  $\delta$ , for hydrocarbon solvents and petroleum constituents. By this means, the solubility parameter of asphaltene constituents can be estimated to be a range of values that is also in keeping with the asphaltene constituents being composed of a mixture of different compounds types with the accompanying variation in polarity.

# Solvents

Solvents are liquids or gases that can dissolve or extract other substances and are an essential part of laboratory operations – typically for use to dissolve substances or for cleaning – and must be used with caution. Solvents are used to dissolve materials such as grease, oil, and paint; to thin or mix pigments, paint, glue, and pesticides.

The term “solvents” usually refers to organic solvents, which contain carbon and can be classified into three main types: (1) hydrocarbon solvents, (2) oxygenated solvents, and (3) halogenated solvents. Hydrocarbon solvents contain hydrogen and are derived mainly from petroleum while oxygenated solvents are synthesized from other chemicals.

Halogenated solvents contain one or more of the halogen elements: chlorine, bromine, fluorine, or iodine.

In the interests of safety and health, the properties of any solvent must be determined before use. *Criteria documents* have been developed by the National Institute for Occupational Safety and Health (NIOSH) and should be consulted to prevent disease and hazardous conditions in the workplace. These criteria documents generally contain a critical review of the scientific and technical information available on the prevalence of hazards, the existence of safety and health risks, and the adequacy of methods to identify and control hazards.

Table Properties of common organic solvents.

Solvent	Formula	Molecular	Boiling point degrees C	Melting point degrees C	Density g/ml	Solubility in water g/100 ml water	Dielectric constant	Flash point degrees C
acetic acid	$C_2H_4O_2$	60.052	118	16.6	1.0446	Miscible	6.2	39
acetone	$C_3H_6O$	58.079	56.05	-94.7	0.7845	Miscible	21.01	-20
acetonitrile	$C_2H_3N$	41.052	81.65	-43.8	0.7857	Miscible	36.64	6
benzene	$C_6H_6$	78.11	80.1	5.5	0.8765	0.18	2.28	-11
1-butanol	$C_4H_{10}O$	74.12	117.7	-88.6	0.8095	6.3	17.8	37
2-butanol	$C_4H_{10}O$	74.12	99.5	-88.5	0.8063	15	17.26	24
2-butanone	$C_4H_8O$	72.11	79.6	-86.6	0.7999	25.6	18.6	-9
<i>t</i> -butyl alcohol	$C_4H_{10}O$	74.12	82.4	25.7	0.7887	Miscible	12.5	11
carbon tetrachloride	$CCl_4$	153.82	76.8	-22.6	1.594	0.08	2.24	-
chlorobenzene	$C_6H_5Cl$	112.56	131.7	-45.3	1.1058	0.05	5.69	28
chloroform	$CHCl_3$	119.38	61.2	-63.4	1.4788	0.795	4.81	-
cyclohexane	$C_6H_{12}$	84.16	80.7	6.6	0.7739	<0.1	2.02	-20
1,2-dichloroethane	$C_2H_4Cl_2$	98.96	83.5	-35.7	1.245	0.861	10.42	13
diethylene glycol	$C_4H_{10}O_3$	106.12	246	-10	1.1197	10	31.8	124
diethyl ether	$C_4H_{10}O$	74.12	34.5	-116.2	0.713	7.5	4.267	-45
diglyme (diethylene glycol dimethyl ether)	$C_6H_{14}O_3$	134.17	162	-68	0.943	Miscible	7.23	67
dimethyl-formamide (DMF)	$C_3H_7NO$	73.09	153	-60.48	0.9445	Miscible	38.25	58
dimethyl sulfoxide (DMSO)	$C_2H_6OS$	78.13	189	18.4	1.092	25.3	47	95
1,4-dioxane	$C_4H_8O_2$	88.11	101.1	11.8	1.033	Miscible	2.21(25)	12
ethanol	$C_2H_6O$	46.07	78.5	-114.1	0.789	Miscible	24.6	13
ethyl acetate	$C_4H_8O_2$	88.11	77	-83.6	0.895	8.7	6(25)	-4
ethylene glycol	$C_2H_6O_2$	62.07	195	-13	1.115	Miscible	37.7	111
glycerin	$C_3H_8O_3$	92.09	290	17.8	1.261	Miscible	42.5	160
heptane	$C_7H_{16}$	100.2	98	-90.6	0.684	0.01	1.92	-4
hexane	$C_6H_{14}$	86.18	69	-95	0.659	0.014	1.89	-22
methanol	$CH_4O$	32.04	64.6	-98	0.791	Miscible	32.6(25)	12
methylene chloride	$CH_2Cl_2$	84.93	39.8	-96.7	1.326	1.32	9.08	1.6
<i>N</i> -methyl-2-pyrrolidinone (NMP)	$CH_3H_9NO$	99.13	202	-24	1.033	10	32	91
Nitromethane	$CH_3NO_2$	61.04	101.2	-29	1.382	9.5	35.9	35

Pentane	$C_5H_{12}$	72.15	36.1	-129.7	0.626	0.04	1.84	-49
Petroleum ether (ligroine)	-	-	30-60	-40	0.656	-	-	-30
1-propanol	$C_3H_8O$	88.15	97	-126	0.803	Miscible	20.1(25)	15
2-propanol	$C_3H_8O$	88.15	82.4	-88.5	0.785	Miscible	18.3(25)	12
Pyridine	$C_5H_5N$	79.1	115.2	-41.6	0.982	Miscible	12.3(25)	17
tetrahydrofuran (THF)	$C_4H_8O$	72.106	65	-108.4	0.8833	30	7.52	-14
Toluene	$C_7H_8$	92.14	110.6	-93	0.867	0.05	2.38(25)	4
triethyl amine	$C_6H_{15}N$	101.19	88.9	-114.7	0.728	0.02	2.4	-11
Water	$H_2O$	18.02	100	0	0.998	-	78.54	-
water, heavy	$D_2O$	20.03	101.3	4	1.107	Miscible	??	-
<i>o</i> -xylene	$C_8H_{10}$	106.17	144	-25.2	0.897	Insoluble	2.57	32
<i>m</i> -xylene	$C_8H_{10}$	106.17	139.1	-47.8	0.868	Insoluble	2.37	27
<i>p</i> -xylene	$C_8H_{10}$	106.17	138.4	13.3	0.861	Insoluble	2.27	27





# Specific Gravity

The specific gravity is the mass (or weight) of a unit volume of any substance at a specified temperature compared to the mass of an equal volume of pure water at a standard temperature. Substances with a specific gravity greater than one are denser than water, and so will sink in it, and those with a specific gravity of less than one are less dense than water, and so will float in it.

Specific gravity,  $SG$ , is expressed mathematically as:

$$SG = \frac{\rho_{\text{substance}}}{\rho_{\text{H}_2\text{O}}}$$

$\rho_{\text{substance}}$  is the density of the substance, and  $\rho_{\text{H}_2\text{O}}$  is the density of water.

The density of water varies with temperature and pressure, and it is usual to refer specific gravity to the density at 4 °C (39.2 °F) and a normal pressure of 1 atmosphere. The given temperature and pressure are preferred because it is when water has its maximum density. In this case  $\rho_{\text{H}_2\text{O}}$  is equal to 1000 kg·m<sup>-3</sup> in SI units (or 62.43 lbm·ft<sup>-3</sup> in the customary units of the United States. Given the specific gravity of a substance, its actual density can be calculated by inverting the above formula:

$$\rho_{\text{substance}} = SG \times \rho_{\text{H}_2\text{O}}$$

Occasionally a reference substance other than water is specified (for example, air), in which case specific gravity means density relative to that reference.

In addition, the specific gravity of gas can also be determined and is defined as:

$$\gamma_g = \frac{M}{M_{\text{air}}}$$

$M_{\text{air}}$  is the molecular weight of air, which is equal to 29. Once we can calculate the value of the molecular weight of the mixture, we can calculate the specific gravity of the mixture. For a gas mixture, the molecular weight can be calculated as:

$$M = \sum_{i=1}^n y_i M_i$$

$M_i$  is the molecular weight of component  $i$ ,  $y_i$  is the mole fraction of component  $i$ , and  $n$  is the total number of components.



# Specific Heat

*Specific heat* is the quantity of heat required to raise a unit mass of material through one degree of temperature (ASTM D2766). Specific heats are extremely important engineering quantities in refinery practice because they are used in all calculations on heating and cooling petroleum products. Many measurements have been made on various

hydrocarbon materials, but the data for most purposes may be summarized by the general equation:

$$C = 1/d (0.388 + 0.00045t)$$

$C$  is the specific heat at  $t$  °F of an oil whose specific gravity 60/6 °F is  $d$ ; thus, specific heat increases with temperature and decreases with specific gravity.



# Stress-Corrosion Cracking

When an alloy fails by a distinct crack, stress-corrosion cracking is often the cause. Cracking will occur when there is a combination of corrosion and stress (either externally applied or internally applied by residual stress). It may be either intergranular or transgranular, depending on the alloy and the type of corrosion. Austenitic stainless steels (the 300 series) are particularly susceptible to stress-corrosion cracking. Frequently, chlorides in the process stream are the cause of this type of attack. Removal of the chloride derivatives is helpful in eliminating stress-corrosion cracking. Austenitic stainless steels are based on austenite, which is a metallic, non-magnetic different structural modification (allotrope) of iron.

Many austenitic stainless steels have failed during downtime because the piping or tubes were not protected from chlorides. A good precaution is to blanket austenitic stainless steel piping and tubing during downtime with an inert gas (nitrogen). If furnace tubes become sensitized and fail by stress corrosion cracking, the remaining tubes can be stabilized by a heat treatment of 24 hours at 870 °C (1600 °F). Chemically stabilized steel, such as Type 304L steel, have

been successfully used in a sulfidic corroding environment but actual installation tests have not been consistent. Straight chromium ferritic stainless steels are less sensitive to stress corrosion cracking than austenitic steels (18 Cr-8 Ni) but are noted for poor resistance to acidic condensates. In water solutions containing hydrogen sulfide, austenitic steels fail by stress corrosion cracking when they are quenched and tempered to high strength and hardness (above about Rockwell C24).

300 Series austenitic stainless steel has austenite as its primary phase. These alloys contain chromium and nickel and sometimes molybdenum and nitrogen, structured around the Type 302 composition of iron, 18% w/w chromium, and 8% w/w nickel. The 200 Series austenitic stainless steels replace the majority of their nickel content with manganese to reduce cost. Austenitic steels are not hardened by heat treatment. The most familiar stainless steel is probably SAE 304 stainless steel, also called 18/8 or A2 stainless steel and is an austenitic steel containing 18 to 20% w/w chromium and 8 to 10% w/w nickel.



# Sulfur Dioxide

**Table** Physical properties of sulfur dioxide.

Molecular weight	64.063
Vapour pressure at 21 °C	2.37 bar
Specific volume at 21°C, 1 atm	368.3 ml/g
Boiling point at 1 atm	-10.0 °C
Freezing point at 1 atm	-75.5 °C
Specific gravity, gas at 0 °C, 1 atm (air = 1)	2.264
Density, gas at 0 °C, 1 atm	2.927 g/l
Density, liquid at -10 °C	1.46 g/ml
Critical temperature	157.5 °C
Critical pressure	78.8 bar
Critical density	0.524 g/ml
Latent heat of vaporization at boiling point	92.8 cal/g
Latent heat of fusion at melting point	27.6 cal/g
Specific heat, liquid at 0 °C	0.318 cal/g °C
Specific heat, gas at 25 °C, 1 atm	
$C_p$	0.1488 cal/g °C
$C_v$	0.1154 cal/g °C
ratio $C_p/C_v$	1.29
Thermal conductivity at 0 °C	$2.06 \times 10^{-5}$ cal/s cm <sup>2</sup> °C/cm
Viscosity, gas at 18 °C, 1 atm	124.2 mP
Solubility in water at 0 °C, 1 atm	18.59% by weight
at 20 °C, 1 atm	10.14% by weight





## Sulfur Material Balance

For crude oil containing significant amounts of sulfur, it is necessary to make a sulfur balance around the crude unit – this involves data for the sulfur content of the crude oil feedstock and the products. Thus, for fractions with a molecular weight <200:

$$\text{wt}\%S = 177.448 - 170.946R_i + 0.2258m + 4.054SG$$

For fractions with a molecular weight >200:

$$\text{wt}\%S = -58.02 + 38.463R_i - 0.023m + 22.4SG$$

SG is the specific gravity,  $R_i$  is the refractivity intercept ( $R_i = n - d/2$ ) where  $n$  and  $d$  are the refractive index and density of liquid hydrocarbon at 20 °C (68 °F) in g/cm<sup>3</sup>. The parameter  $m$  is  $M(n - 1.475)$ .

After calculating the sulfur content (% w/w) each product except the vacuum residue, the amount of sulfur is calculated by multiplying this percentage by the mass rate of each product. The sulfur in the vacuum residue is calculated from the difference of the total sulfur in the crude feed and the total sulfur in the products.



# Supercritical Fluids

A supercritical fluid is any substance at a temperature and pressure above the critical point (Table 1, Table 2), where distinct liquid and gas phases do not exist, and which can effuse through solids like a gas and dissolve materials like a liquid.

Furthermore, there is no surface tension in a supercritical fluid, as there is no liquid/gas phase boundary. In addition, close to the critical point, small changes in pressure or temperature result in large changes in density thereby allowing many properties of a supercritical fluid to be adjusted to be more liquid-like or more gas-like. All supercritical fluids are completely miscible with each other so for a mixture a single phase can be guaranteed if the critical point of the

mixture is exceeded. The critical point of a binary mixture can be estimated as the arithmetic mean of the critical temperatures and pressures of the two components:

$$T_{c(mix)} = (\text{mole fraction } A) \times T_c A + (\text{mole fraction } B) \times T_c B$$

$T_{c(mix)}$  is the critical temperature of the mixture,  $A$  is component  $A$ ,  $T_c A$  is the critical temperature of component  $A$ ,  $B$  is component  $B$ , and  $T_c B$  is the critical temperature of component  $B$ . For greater accuracy, the critical point can be calculated using equations of state and other properties, such as density, can also be calculated using equations of state.

**Table 1** Critical properties of selected solvents.

Solvent	Molecular weight	Critical temperature, °K	Critical pressure, MPa (atm)	Critical density, g/cm <sup>3</sup>
Carbon dioxide (CO <sub>2</sub> )	44.01	304.1	7.38 (72.8)	0.469
Water (H <sub>2</sub> O)	18.015	647.096	22.064 (217.755)	0.322
Methane (CH <sub>4</sub> )	16.04	190.4	4.60 (45.4)	0.162
Ethane (C <sub>2</sub> H <sub>6</sub> )	30.07	305.3	4.87 (48.1)	0.203
Propane (C <sub>3</sub> H <sub>8</sub> )	44.09	369.8	4.25 (41.9)	0.217
Ethylene (C <sub>2</sub> H <sub>4</sub> )	28.05	282.4	5.04 (49.7)	0.215
Propylene (C <sub>3</sub> H <sub>6</sub> )	42.08	364.9	4.60 (45.4)	0.232
Methanol (CH <sub>3</sub> OH)	32.04	512.6	8.09 (79.8)	0.272
Ethanol (C <sub>2</sub> H <sub>5</sub> OH)	46.07	513.9	6.14 (60.6)	0.276
Acetone (C <sub>3</sub> H <sub>6</sub> O)	58.08	508.1	4.70 (46.4)	0.278
Nitrous oxide (N <sub>2</sub> O)	44.013	306.57	7.35 (72.5)	0.452

**Table 2** Comparison of supercritical fluids with gases and liquids.

	Density, kg/m <sup>3</sup>	Viscosity, μPa s	Diffusivity, mm <sup>2</sup> /s
Gases	1	10	1 to 10
Liquids	1000	500 to 1000	0.001
Supercritical fluids	100 to 1000	50 to 100	0.01 to 0.1



# Surface Tension

The surface tension is the elastic tendency of a fluid surface which makes it acquire the least possible surface area. The surface tension of many liquids is available in tabular form or can be estimated for temperatures other than the ones given in the literature (usually 15 or 20 °C, 59 or 68 °F) by using the following equation:

$$\sigma_2 = \sigma_1 [(T_c + T_2)/(T_c - T_1)]^{1.2}$$

$\sigma_1$  is the surface tension at temperature  $T_1$ ,  $\sigma_2$  is the surface tension at temperature  $T_2$ , and  $T_c$  is the critical temperature of the liquid.

Source:

Speight, J.G. 2014. *The Chemistry and Technology of Petroleum*, 5<sup>th</sup> Edition. CRC Press, Taylor & Francis Group, Boca Raton, Florida.

**Table** Surface tension of selected hydrocarbons.

Hydrocarbon		Surface tension			
	C	20	38	93	
	F	68	100	200	
n-Pentane		16.0	14.0	8.0	dyn/cm
		16.0	14.0	8.0	mN/m
n-Hexane		18.4	16.5	10.9	dyn/cm
		18.4	16.5	10.9	mN/m
n-Heptane		20.3	18.6	13.1	dyn/cm
		20.3	18.6	13.1	mN/m
n-Octane		21.8	20.2	14.9	dyn/cm
		21.8	20.2	14.9	mN/m
Cyclopentane		22.4			dyn/cm
		22.4			mN/m
Cyclohexane		25.0			dyn/cm

Hydrocarbon	Surface tension			
		25.0		mN/m
Tetralin		35.2		dyn/cm
		35.2		mN/m
Decalin		29.9		dyn/cm
		29.9		mN/m
Benzene		28.8		dyn/cm
		28.8		mN/m
Toluene		28.5		dyn/cm
		28.5		mN/m
Ethylbenzene		29.0		dyn/cm
		29.0		mN/m
n-Butylbenzene		29.2		dyn/cm
		29.2		mN/m



# Sweetening Processes

Many chemical processes are available for sweetening natural gas (Table). For decades, the amine (olamine) process (also known as the Girdler process), has been the most widely used method for removal of hydrogen sulfide:

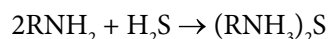

In this equation, R is mono, di, or tri-ethanol, N is nitrogen, H is hydrogen, and S is sulfur.

The recovered hydrogen sulfide gas stream may be: (1) vented, (2) flared in waste gas flares or modern smokeless flares, (3) incinerated, or (4) utilized for the production of elemental sulfur or sulfuric acid. If the recovered hydrogen sulfide gas stream is not to be utilized as a feedstock for commercial applications, the gas is usually passed to a tail gas incinerator in which the hydrogen sulfide is oxidized to sulfur dioxide and water for further processing of the sulfur dioxide.

**Table** Summary of the Natural Gas Sweetening Processes

## Iron-Sponge Sweetening

Reaction:

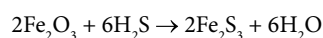

Regeneration:

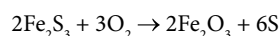

A batch process; most applicable for small gas volume with low content of hydrogen sulfide; operating temperature of the vessel <120 °F (<49 °C).

## Alkanolamine Sweetening

Reaction:

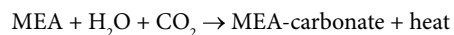

Regeneration:

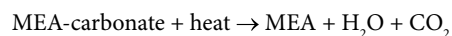
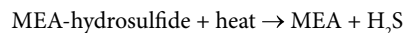

Alkanolamine: organic compounds including monoethanolamine (MEA), diethanolamine (DEA), and triethanolamine (TEA); not selective and have to be designed for total acid-gases removal; operating  $p > 125$  psi for DEA; can absorb most of the acid gases and meet the specified pipeline requirement.

## Glycol/Amine Process

A solution composed of 10–30% w/w MEA, 45–85% w/w glycol, and 5–25% w/w water for the simultaneous removal of water vapor, hydrogen sulfide, and carbon dioxide; the process flow scheme is essentially the same as that for MEA; applicable when low dew point is not required; there can be losses of MEA due to vaporization in the regeneration stage at high temperature.

(Continued)

Table Cont.

**Sulfinol Process**

The solvent (composed of sulfolane, diisopropanolamine (DIPA), and water) acts as the physical (sulfolane) and chemical (DIPA) solvent; there is the benefit of low solvent circulation rates, smaller equipment, and lower cost; on the other hand, there can be absorption of high molecular weight hydrocarbon derivatives and aromatic derivatives.

**Chemsweet Process and Zinc Oxide Process**

Reaction:

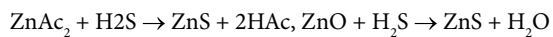

Regeneration:

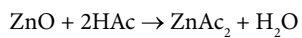

Can be used to treat gas with a high concentration of hydrogen sulfide; operating  $p$  on the order of 89 to 1,415 psi; should not be used when the mercaptan concentration is in excess of 10% v/v hydrogen sulfide in the gas stream – mercaptans react with ZnO and forms Zn(OH)RH which will form a sludge and possibly cause foaming problems.



# Synthesis Gas

Synthesis gas (syngas) is the name given to a gas mixture that is generated by the gasification of a carbon containing fuel (e.g., petroleum coke, coal, biomass, and waste) to a gaseous product that contains varying amounts of carbon monoxide and hydrogen:

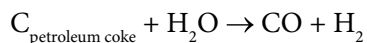
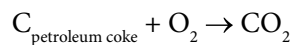

The name *synthesis gas* originates from their use as intermediates in creating synthetic natural gas (SNG) and for producing ammonia and/or methanol. Synthesis gas is also used as an intermediate in producing synthetic fuels via the Fischer-Tropsch reaction. It is also produced from natural gas via the steam reforming reaction:

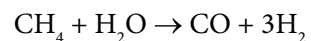

Synthesis gas is combustible and often used as a fuel source or as an intermediate for the production of other chemicals.



# Tar Sand

Tar sand (also referred to as oil sand) is a combination of clay, sand, water, and bitumen, a heavy black viscous material that resembles petroleum residua. Tar sand can be mined and processed to extract the oil-rich bitumen, which is then refined into oil. The bitumen in tar sand cannot be pumped from the ground in its natural state; instead tar sand deposits are mined, usually using strip mining or open pit techniques, or the oil is extracted by underground heating with additional upgrading.

Tar sand has been defined in the United States (FE-76-4) as:

*...the several rock types that contain an extremely viscous hydrocarbon which is not recoverable in its natural state by conventional oil well production methods including currently used enhanced recovery techniques. The hydrocarbon-bearing rocks are variously known as bitumen-rocks oil, impregnated rocks, oil sands, and rock asphalt.*

By inference, heavy oil can be recovered in its natural state by enhanced oil recovery techniques while conventional crude oil can be recovered in its natural state by secondary and primary recovery techniques. Also by inference, black oil does not reliably fit into this definition.

To recover bitumen from tar sand recovery processes involves extraction and separation systems to separate the bitumen from the clay, sand, and water that make up the tar sand. Bitumen also requires additional upgrading before it can be refined. Because it is so viscous (thick), it also requires dilution with lighter hydrocarbons to make it transportable by pipelines.

## Resources

Much of the potential oil of the world (more than 2 trillion barrels,  $2 \times 10^{12}$  barrels) is in the form of tar sand, although it is not all recoverable. While tar sand deposits are found in many places worldwide, the largest deposits are found in Canada (Alberta) and Venezuela, and much of the rest is

found in various countries in the Middle East. In the United States, tar sand resources are primarily concentrated in Eastern Utah, mostly on public lands.

## The Industry

Currently, synthetic crude oil is not produced from tar sand on a significant commercial level in the United States; in fact, only Canada has a large-scale commercial tar sand industry, though a small amount of oil from tar sand is produced commercially in Venezuela. The Canadian tar sand industry is centered in Alberta, and more than one million barrels of synthetic oil are produced from these resources per day. Currently, synthetic crude oil from tar sand deposits represents approximately 40% of Canada's oil production, and output is expanding rapidly. Approximately 20% of U.S. crude oil and products come from Canada, and a substantial portion of this amount comes from tar sand. The bitumen from tar sand is extracted both by mining and *in situ* recovery methods.

## Bitumen Extraction and Processing

Tar sand deposits near the surface can be recovered by open pit mining techniques. New methods introduced in the 1990s considerably improved the efficiency of tar sand mining, thus reducing the cost. These systems use large hydraulic and electrically powered shovels to dig up tar sand and load the material into enormous trucks that can carry up to 320 tons of tar sand per load. After mining, the tar sand is transported to an extraction plant, where a hot water process separates the bitumen from sand, water, and minerals. The separation takes place in separation cells. Hot water is added to the sand, and the resulting slurry is piped to the extraction plant where it is agitated. The combination of hot water and agitation releases bitumen from the oil sand, and causes tiny air bubbles to attach to the bitumen droplets, which float to the top of the separation vessel, where the bitumen can

be skimmed off. Further processing removes residual water and solids. The bitumen is then transported and eventually upgraded into synthetic crude oil. Approximately two tons (4,000 lbs) of tar sand are required to produce one barrel (42 US gallons, 35.5 Imperial gallons) of oil. Approximately 75% v/v of the bitumen can be recovered from sand. After oil extraction, the spent sand and other materials are then returned to the mine, which is eventually reclaimed.

*In situ* production methods are used on bitumen deposits buried too deep for mining to be economically recovered. These techniques include steam injection, solvent injection, and firefloods, in which oxygen is injected and part of the resource burned to provide heat. So far steam injection has been the favored method. Some of these extraction methods

require large amounts of both water and energy (for heating and pumping).

Both mining and processing of tar sand involve a variety of environmental impacts, such as global warming and greenhouse gas emissions, disturbance of mined land; impacts on wildlife and air and water quality. The development of a commercial tar sand industry in the United States would also have significant social and economic impacts on local communities. Of special concern in the relatively arid western United States is the large amount of water required for tar sand processing; currently, tar sand extraction and processing require several barrels of water for each barrel of oil produced, though some of the water can be recycled.

**Table 1** Simplified differentiation between conventional crude oil, heavy oil, extra heavy oil, tar sand bitumen, oil shale kerogen, tight oil, and coal.

<b>Conventional Crude Oil</b>
Mobile in the reservoir; API gravity: >25°
High-permeability reservoir
Primary recovery
Secondary recovery
<b>Tight Oil</b>
Similar properties to the properties of conventional crude oil; API gravity: >25°
Immobile in the reservoir
Low-permeability reservoir
Horizontal drilling into reservoir
Fracturing (typically multi-fracturing) to release fluids/gases
<b>Medium Crude Oil</b>
Similar properties to the properties of conventional crude oil; API gravity: 20–25°
High-permeability reservoir
Primary recovery
Secondary recovery

<b>Heavy Crude Oil</b>
More viscous than conventional crude oil; API gravity: 10–20°
Mobile in the reservoir
High-permeability reservoir
Secondary recovery
Tertiary recovery (enhanced oil recovery – EOR; e.g. steam stimulation)
<b>Extra Heavy Oil</b>
Similar properties to the properties of tar sand bitumen; API gravity: <10°
Mobile in the reservoir
High-permeability reservoir
Secondary recovery
Tertiary recovery (enhanced oil recovery – EOR; e.g. steam stimulation)
<b>Tar Sand Bitumen</b>
Immobile in the deposit; API gravity: <10°
High-permeability reservoir
Mining (often preceded by explosive fracturing)
Steam assisted gravity draining (SAGD)
Solvent methods (VAPEX)
Extreme heating methods
Innovative methods*

\*Innovative methods excludes tertiary recovery methods and methods such as SAGD, VAPEX but does include variants or hybrids thereof

Table 2 Properties of bitumen from different California tar sand deposits.

Deposit/Field	Reservoir temperature F	Reservoir permeability mD	Reservoir porosity	API	Viscosity cP reservoir conditions	Viscosity cP 80 F	Viscosity cP 87 F	Viscosity cP 100 F	Viscosity Cp 200 F	Sulfur % w/wt
Arroyo Grande		700	38	8				15,000		3 to 5
Basal Foxen		300	25	9 to 17 (9.5)		47,000				4 to 5
Cat Canyon				0 to 12 (6)						
Brooks Sand	135	1,400-5,000	32	0 to 12	15,000					
S Sand	110	3,450	37		12,000 to 1,000,000					
Casmalia		<1	48							
Zaca-Sisquoc			35	4 to 6						
Oxnard (Vaca)		6,000	35	5				500,000	2,000	6 to 7
Paris Valley		3,700	32							1.5
Upper Lobe							227,000			
Lower Lobe							23,000			
Midway-Sunset										
Webster Sands	100	1300	28	14				1,650		

**Table 3** Specific Gravity, API Gravity, and Viscosity of Various Bitumen Samples.

Source	Specific gravity	API gravity	Viscosity cP	F
Athabasca (Canada)				
Mildred-Ruth Lakes	1.025	6.5	35,000	100
Abasand	1.027	6.3	500,000	100
	1.034	5.4	570,000	100
Ells River	1.008	8.9	25,000	
Utah (United States)				
Asphalt Ridge			610,000	140
Tar Sand Triangle			760,000	140
Sunnyside			1,650,000	100
California				
Arroyo Grande	1.055	2.6	1,300,000	220

# Test Methods

**Table** Standard Test Methods for Petroleum and Petroleum Fractions.

	TBP (°F)	ASTM distillation (D86/D1160)	True boiling point (D2892))	Simulate distillation (D5307)	API/SG (D1298)	Total sulphur (D4294)	Mercaptants (D3227)	H <sub>2</sub> S (D325)	Total nitrogen D4629	Viscosity (2 Temp) D445 (D446)	Pour point (D97)	Organic chlorides (D4929)	Acid number (D664)	Carbon residue (D189)	Metals (D5708)	Cetane index (D4737)	Aniline point (D611)	Smoke point (D1322)	Octane number (D2700)	Vapour pressure (D323)	Wax and asphaltene	Sediment and water (D473)	Salt content (D6470)	Refractive index (D1218)
Crude		x	x	x	x	x	x	x	x	x	x	x	x	x	x					x	x	x	x	x
LPG		x	x	x	x																			
LSR	90–180	x	x	x	x	x	x	x				x							x					
HSR	180–380	x	x	x	x	x	x	x				x					x		x					x
Kero	380–520	x	x		x	x	x	x	x	x		x	x			x	x	x						x
LGO	520–610	x	x		x	x			x	x	x		x			x	x	x						x
HGO	610–800	x	x		x	x			x	x	x			x	x						x			
VGO	800–1050				x	x			x	x	x			x		x	x				x			x
VR	1050+				x	x			x	x				x	x						x			

LPG: Liquefied petroleum gas.

LSR: Light naphtha.

HSR: Heavy naphtha

Kero: Kerosene.

LGO: Light gas oil.

HGO: Heavy gas oil.

VGO: Vacuum gas oil.

VR: Vacuum Residuum.





# Thermal Conductivity

The *thermal conductivity* is a measure of the effectiveness of a material as a thermal insulator. The energy transfer rate through a substance is proportional to the temperature gradient across the substance and the cross-sectional area of the body. In the limit of infinitesimal thickness and temperature difference, the fundamental law of heat conduction is:

$$Q = \lambda AdT/dx$$

Q is the heat flow, A is the cross-sectional area,  $dT/dx$  is the temperature/thickness gradient, and  $\lambda$  is the thermal conductivity.

A substance with a large thermal conductivity value is a good conductor of heat; one with a small thermal conductivity value is a poor heat conductor (i.e., a good insulator).

Thermal conductivity describes the ease with which conductive heat can flow through a vapor, liquid, or solid layer of a substance. It is defined as the proportionality constant in Fourier's law of heat conduction in units of energy-length/time-area-temperature (e.g., W/mK).

For pure component, low pressure (<350 kPa) hydrocarbon gases:

$$k_c = 4.45 \times 10^{-7} T_r C_p / \lambda$$

For these hydrocarbons above reduced temperatures of 1.0 and for other hydrocarbons at any temperature:

$$k_c = 10^{-7} (14.52T_r - 5.14)^{2/3} \left( \frac{C_p}{\lambda} \right)$$

In these equations,

(2/3

$$\lambda = T_r / 6M^{1/2} \underline{101.325}$$

r:

where  $k_c$  = vapor thermal conductivity, W/m-K

$T_r$  = reduced temperature,  $T/T_c$

T = temperature, K

$T_c$  = critical temperature, °K

$C_p$  = heat capacity at constant pressure, J/kmol·K M = molecular weight

$P_c$  = critical pressure, kPa

$C_p$  may be assumed to be the ideal gas heat capacity, cg

Average errors can be expected to be less than 5%

For *pure nonhydrocarbon* gases at low pressures (up through 1 atm), the following equations may be used at temperature T (K)

$$\text{Monatomic gases: } k_c = 2.5 \frac{\eta_c C_v}{M}$$

$$\text{Linear molecules: } k_c = \frac{\eta_c}{M} \left( 1.30C_v + 14644.0 - \frac{2928.8}{T_r} \right)$$

$$\text{Nonlinear molecules: } k_c = \frac{\eta_c}{M} (1.15C_v + 16903.36)$$

where  $k_c$  = vapour thermal conductivity, W/m-K

$\eta_c$  = vapour viscosity, Pa-s

$C_v$  = heat capacity at constant volume, J/Kmol·K

M = molecular weight

$T_r$  = reduced temperature,  $T/T_c$

$T_c$  = critical temperature, K

For *pure component hydrocarbon* liquids at reduced temperatures between 0.25 and 0.8 and at pressures below 3.4 MPa:

$$k_L = C\rho M^n \left[ \frac{3 + 20(1 - T_r)^{2/3}}{3 + 20 \left( 1 - \frac{293.15}{T_c} \right)^{2/3}} \right]$$

where  $k_L$  = liquid thermal conductivity, W/mK

M = molecular weight

$\rho$  = molar density at 293.15 K, kmol/m<sup>3</sup>

$T_r$  = reduced temperature, K  
 $T$  = temperature, K  
 $T_c$  = critical temperature, K

For unbranched, straight chain hydrocarbons,  $n = 1.001$  and  $C = 1.811 \times 10^{-4}$ .

For branched and cyclic hydrocarbons,  $n = 0.7717$  and  $C = 4.407 \times 10^{-4}$ .

Average errors are 5% when this equation is used. For pressures greater than 3.4 MPa, the thermal conductivity (Eq. 109) may be corrected. The correction factor is the ratio of conductivity factors  $F/F_r$ , where  $F$  is at the desired temperature and higher pressure, and  $F_r$  is at the same temperature and lower pressure (usually atmospheric). The conductivity factors are calculated from:

$$F = 17.77 + 0.065P_r - 7.764T_r - \frac{2.054T_r^2}{e^{0.2P_r}}$$

where  $T_r$  = reduced temperature  
 $P_r$  = reduced pressure,  $P/P_c$   
 $P$  = pressure, MPa  
 $P_c$  = critical pressure, MPa

For pure component hydrocarbon liquids above the normal boiling point and all pressures:

$$k_L = \frac{\alpha e^{\beta P_r}}{\lambda} \quad p < 10,000 \text{ kPa}$$

$$k_L = \frac{2.596 \times 10^{-4} P_r^{1.6} + \alpha e^{\beta P_r}}{\lambda} \quad p > 10,000 \text{ kPa}$$

where  $k_L$  = liquid thermal conductivity at the temperature  $T$ (K) and pressure  $P$ (kPa) of interest, W/mK

$$\alpha = 0.0112 \beta^{-3.322}$$

$$\beta = 0.40 + 0.986e^{-0.64\lambda}$$

$$\lambda = T_c^{1/6} M^{1/2} \left( \frac{101.325}{P_c} \right)^{2/3}$$

$\rho_r$  = reduced density =  $V_c/V$

$V_c$  = critical molar volume,  $\text{m}^3/\text{kmol}$

$V$  = molar volume at  $T$  and  $P$ ,  $\text{m}^3/\text{kmol}$

$T_c$  = critical temperature, K

$M$  = molecular weight

$P_c$  = critical pressure, kPa

$P_r$  = reduced pressure,  $P/P_c$

**Table** Thermal Conductivity of Gases at Different Temperatures\*.

	100 °K	200 °F	300 °K	400 °K	500 °K	600 °K
Air	9.4	18.4	26.2	33.3	39.7	45.7
Ammonia			24.4	37.4	51.6	66.8
Butane			16.4	28.4	43.0	59.1
Carbon dioxide		9.6	16.8	25.1	33.5	41.6
Carbon monoxide			25.0	32.3	39.2	45.7
Ethane		11.0	21.3	35.4	52.2	70.5
Ethylene		11.1	20.5	34.6	49.9	68.6
Hexane				23.4	35.4	48.7
Hydrogen	68.6	131.7	186.9	230.4		
Hydrogen sulfide			14.6	20.5	26.4	32.4
Methane		22.5	34.1	49.1	66.5	84.1
Nitric oxide		17.8	25.9	33.1	39.6	46.2
Nitrogen	9.8	18.7	26.0	32.3	38.3	44.0
Nitrous oxide		9.8	17.4	26.0	34.1	41.8
Oxygen	9.3	18.4	26.3	33.7	41.0	48.1
Pentane			14.4	24.9	37.8	562.7
Propane			18.0	30.6	45.5	61.9
Sulfur dioxide			9.6	14.3	20.0	25.6
Water			18.7	27.1	35.7	47.1

\*Units: mW/m K (milliwatts per meter Kelvin)

# Thermal Cracking Processes

Crude oil refining is the separation of petroleum into fractions and the subsequent treating of these fractions to yield a marketable product. A refinery is essentially a group of manufacturing plants which vary in number with the variety of products produced using a variety of processes and process parameters, such as thermal cracking processes (Table). Refinery processes must be selected and products manufactured to give a balanced operation in which petroleum is

converted into a variety of products that are in accord with the demand for each. To prevent the occurrence of oversupply or underdemand, the refinery must be flexible and be able to change operations as needed. This usually means more processes: thermal processes to change an excess of heavy fuel oil into more gasoline with coke as the residual product, or a vacuum distillation process to separate the heavy oil into lubricating oil stocks and asphalt.

**Table** Comparison of Various Thermal Cracking Processes.

<b>Thermal cracking</b>
Purpose: to produce volatile products of low-volatile or non-volatile feedstocks
Conversion was the prime purpose
Cracking with simultaneous removal of distillate (semi-continuous)
Batch cracking (non-continuous)
High conversion
Process configuration: various
<b>Visbreaking</b>
Purpose: to reduce viscosity of fuel oil to acceptable levels
Conversion is not a prime purpose
Mild (470 to 495 °C; 880 to 920 °F) heating at pressures of 50 to 200 psi
Reactions quenched before going to completion
Low conversion (10%) to products boiling less than 220 °C (430 °F)
Heated coil or drum (soaker)
<b>Delayed coking</b>
Purpose: to produce maximum yields of distillate products
Moderate (480 to 515 °C; 900 to 960 °F) heating at pressures of 90 psi

Reactions allowed to proceed to completion
Complete conversion of the feedstock
Soak drums (845 to 900 °F) used in pairs (one on stream and one off stream being de-coked)
Coked until drum solid
Coke removed hydraulically from off-stream drum
Coke yield: 20–40% by weight (dependent upon feedstock)
Yield of distillate boiling below 220 °C (430 °F): ca. 30% (but feedstock dependent)
<b>Fluid coking</b>
Purpose: to produce maximum yields of distillate products
Severe (480 to 565 °C; 900 to 1050 °F) heating at pressures of 10 psi
Reactions allowed to proceed to completion
Complete conversion of the feedstock
Oil contacts refractory coke
Bed fluidized with steam; heat dissipated throughout the fluid bed
Higher yields of light ends (<C <sub>3</sub> ) than delayed coking
Lower yield of coke than delayed coking (for one particular feedstock)



# Tight Formations

The terms *tight oil* and *tight gas* refer to crude oil (primarily light sweet crude oil) and natural gas, respectively, that are contained in formations such as shale or tight sandstone, where the low permeability of the formation makes it difficult for producers to extract the crude oil or natural gas except by unconventional techniques such as horizontal drilling and hydraulic fracturing. The terms *unconventional oil* or *unconventional gas* are umbrella terms for crude oil and natural gas that are produced by methods that do not meet the criteria for conventional production. Unlike conventional mineral formations containing natural gas and crude oil reserves, shale and other tight formations have low permeability, which naturally limits the flow of natural gas and crude oil. In such formations, the natural gas and crude oil are held in largely unconnected pores and natural fractures. Hydraulic fracturing is the method commonly used to connect these pores and allow the gas to flow.

Tight sandstone formations and shale formations are heterogeneous and vary widely over relatively short distances. Thus, even in a single horizontal drill hole, the amount of gas or oil recovered may vary, as may recovery within a field or even between adjacent wells. This makes evaluation of tight

plays (a *play* is a group of fields sharing geological similarities where the reservoir and the trap control the distribution of oil and gas. Because of the variability of the reservoirs – even reservoirs within a play – decisions regarding the profitability of wells on a particular lease are difficult. Furthermore, the production of crude oil from tight formations requires that at least 15 to 20% v/v of the reservoir pore space is occupied by natural gas to provide the necessary reservoir energy to drive the oil toward the borehole; tight reservoirs which contain only oil cannot be economically produced (EIA, 2013).

In tight shale reservoirs and other tight reservoirs, there are areas known as *sweet spots* which are preferential targets for drilling and releasing the gas and oil. In these areas, the permeability of the formation is significantly higher than the typical permeability of the majority of the formations. The occurrence of a sweet spot and the higher permeability may often result from open natural fractures, formed in the reservoir by natural stresses, which results in the creation of a dense pattern of fractures. Such fractures may have reclosed, filled in with other materials, or may still be open. However, a well that can be connected through hydraulic fracturing to open natural fracture systems can have a significant flow potential.

**Table 1** Typical properties of fluids occurring in shale formations and in tight formations.

Constituents (% v/v)	Dry gas	Wet gas	Condensate	Volatile oil*
CO <sub>2</sub>	0.1	1.4	2.4	1.8
N <sub>2</sub>	2.1	0.3	0.3	0.2
C <sub>1</sub>	86.1	92.5	73.2	57.6
C <sub>2</sub>	5.9	3.2	7.8	7.4
C <sub>3</sub>	3.6	1.0	3.6	4.2
Butane derivatives (C <sub>4</sub> )	1.7	0.5	2.2	2.8
Pentane derivatives (C <sub>5</sub> )	0.5	0.2	1.3	1.5
Hexane derivatives (C <sub>6+</sub> )		0.1	1.1	1.9
Heptane derivatives (C <sub>7+</sub> )		0.8	8.2	22.6

\*Representative of Crude Oil from Tight Formations and Tight Shale Formations.

The development of deep shale oil and gas resources are typically found thousands of feet below the surface of the Earth in tight, low-permeability shale formations. Until recently the vast quantities of natural gas in these formations were thought to be unrecoverable. However,

through the use of hydraulic fracturing, combined with recently improved horizontal drilling techniques, extraordinary amounts of natural gas and crude oil are produced from deep shale formations across the United States.

**Table 2** Comparison of selected properties of crude oils from tight formations (Eagle Ford, Bakken) with conventional light crude oils (Louisiana light sweet crude oil) and brent crude oil.

	<b>Eagle Ford</b>	<b>Bakken</b>	<b>Louisiana light sweet LLS</b>	<b>Brent (North Sea)</b>
API	44–46	42–44	36–38	37–39
Sulfur, % w/w	0.2–0.3	0.05–0.10	0.35–0.45	0.35–0.45
N, ppm	200–400	300–500	900–1200	900–1100
TAN <sup>1</sup>	0.05–0.1	0.01–0.05	0.5–0.6	0.05–0.10
Light ends <sup>2</sup> , % v/v	13–14%	15–16	9–11	10–12
Naphtha, % v/v	22–24	25–27	19–21	19–21
Middle-distillates, % v/v	31–33%	31–32	33–34	29–31
Vacuum gas oil, % v/v	24–26%	22–24	28–29	28–30
Residuum, % v/v	4–6%	3–5	7–9	9–11

<sup>1</sup>TAN: total acid number.

<sup>2</sup>Light ends: low molecular weight organic constituents such as methane, ethane, propane, and butane which are included as components in the oil; in some crude assays, pentane and hexane may be included in the light ends fraction.

**Table 3** Simplified differentiation between conventional crude oil and crude oil from shale formations.

<b>Conventional crude oil</b>
Medium-to-high API gravity
Low-to-medium sulfur content
Mobile in the reservoir
High-permeability reservoir
Primary recovery
Secondary recovery
May use tertiary recovery when reservoir energy is depleted
<b>Tight oil</b>
High API gravity
Low sulfur content
Immobile in the reservoir
Low-to-zero permeability reservoir
Primary, secondary, and tertiary methods of recovery ineffective
Horizontal drilling into reservoir
Fracturing (typically multi-fracturing) to release reservoir fluids

**Table 4** Common characteristics of tight oils.

<i>Advantages</i>
Gravity ranges 40 to 65°API
High yield of distillates
Low sulfur levels
Low levels of nitrogen
High paraffin content
Heavy metals (Ni & V) are low
Low yield of residuum
<i>Disadvantages</i>
Batch to batch variability
Unstable blends when mixed with some crude oils
The presence of hydrogen sulfide can be an issue
High paraffin content
Level of alkaline metals may be high
Other contaminants (Ba, Pb) may be present
Filterable solids: greater volume and smaller particle size
Presence of production chemicals or contaminants.
Low yield of residuum and (therefore) low yield of asphalt

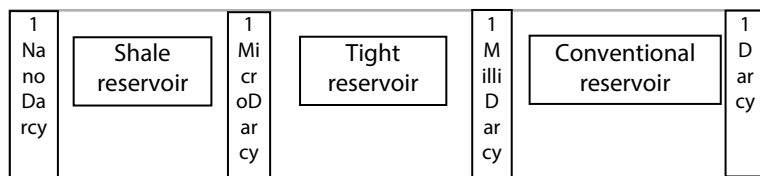

**Figure** Representation of the differences in permeability of shale reservoirs, tight reservoirs, and conventional reservoirs.

# Unit Process

A unit process (sometimes referred to as a unit operation) is a basic physical operation in natural gas processing and in petroleum processing (Table). Examples are distillation, absorption, fluid flow, as well as heat and mass transfer. Fundamentals pertaining to a given unit operation are the same regardless of its industrial applications. Examples are:

- Fluid flow, which deals with the principles governing the flow and transportation of fluids.
- Heat transfer, which deals with the principles underlying the heat transfer by different methods.
- Distillation, absorption, extraction, and drying – which are also referred to as diffusional mass transfer unit operations – in which the separation of natural gas and crude oil hydrocarbons is accomplished by the transfer of molecules from one phase to the other by diffusion.

The significance of introducing the unit operation concept in understanding the processing surface operations in a natural gas field or an oil field is apparent when it is realized that most of these surface operations are *physical operations*

*processes or non-reacting processes*. The processes focus on the transfer and the transformation of *energy*, and the transfer, separation, and conditioning (treating) of *materials* by physical means. Three modes of transfer that take place in oil field processing operations are recognized as follows: (1) Momentum transfer, which is achieved by fluid flow, (2) heat transfer of crude oil and crude oil products using heat exchangers and furnaces, and (3) mass transfer in distillation columns, absorbers, and others that lead to enrichment and separation in which the transfer is due to the diffusion of the molecular constituents that separates the low-boiling constituents from the higher boiling constituents.

**Table** Examples of unit processes.

<i>Unit operation</i>	<i>Application</i>
Equilibrium flashing	Gas-oil separation
Distillation/stripping	Crude oil stabilization
Absorption	Gas Treatment
Fluid flow	Field operations
Heat transfer	Field operations





# Vapor Density

In the context of natural gas, the vapor density is the density of any gas compared to the density of air with the density of air equal to unity.

For example, relative to air, methane is less dense (Table) but the other hydrocarbon constituents of unrefined natural gas (i.e., ethane, propane, butane, and higher molecular weight hydrocarbons) are denser than air (Figure). Therefore, should a natural gas leak occur in field operations, especially where the natural gas contains constituents other than methane, only methane dissipates readily into the air whereas the other hydrocarbon constituents that are heavier than air do not readily dissipate into the atmosphere.

This poses considerable risk if these constituents of natural gas accumulate or pool at ground level when it has been erroneously assumed that natural gas is lighter than air.

**Table** Boiling point and density of methane relative to air and water.

- Boiling Point (760 mm Hg): -161.5c °C (-258.7 °F)
- Gas Specific Gravity: 0.55 to 0.64 (air = 1.00)
- Specific Gravity of Liquefied Natural Gas: 0.42 to 0.46 (water = 1.00)
- Gas Density (varies slightly): 0.0438 lb/scf

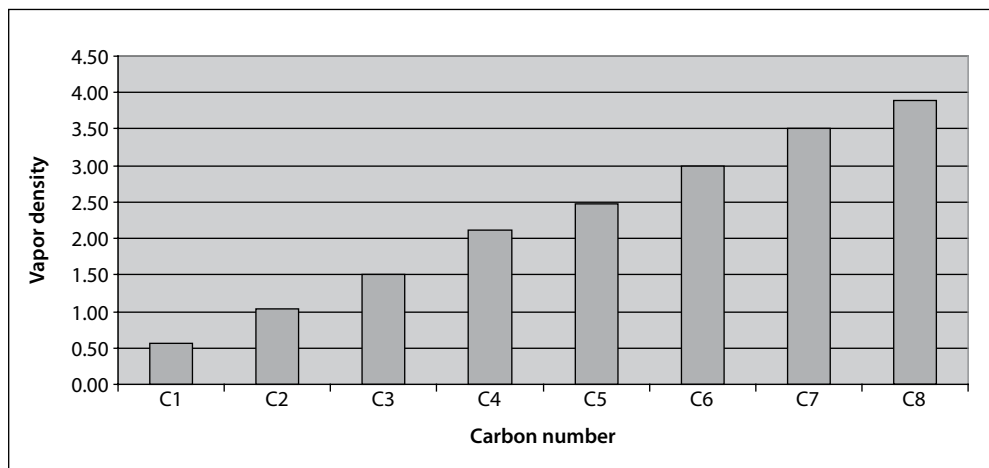

**Figure** Carbon number and vapor density (relative to air = 1.0) of natural gas hydrocarbons (up to octane, C<sub>8</sub>H<sub>18</sub>).



# Vapor Pressure

The *vapor pressure* is the force exerted on the walls of a closed container by the vaporized portion of a liquid. Conversely, it is the force that must be exerted on the liquid to prevent it from vaporizing further (ASTM D323). The vapor pressure increases with temperature for any given gasoline, liquefied petroleum gas, or other products. The temperature at which the vapor pressure of a liquid, either a pure compound or a mixture of many compounds, equals 1 atmosphere (14.7 psi, absolute) is designated as the boiling point of the liquid.

The vapor pressure of a chemical provides an indication of its volatility at any specific temperature. As an approximation, the vapor pressure  $p$  of a pure chemical is given by:

$$\log_e p = (A/T) + B$$

$A$  and  $B$  are empirically determined constants and  $T$  is the absolute temperature. Hence the vapor pressure of a chemical will increase markedly with temperature.

For a component 'a' in a mixture of vapors, its partial pressure  $p_a$  is the pressure that would be exerted by that component at the same temperature if present alone in the same volumetric concentration. So with a mixture of two components, 'a' and 'b', the total pressure is:

$$P = p_a + p_b$$

If an inert gas is also present, its pressure is additive:

$$P = p_a + p_b + p_{\text{inert}}$$

In an 'ideal mixture' the partial pressure  $p_a$  is proportional to the mole fraction  $y_a$  of the component in the gas phase:

$$p_a = y_a P$$

This partial pressure is also related to the concentration in the liquid phase expressed as mole fraction  $x_a$  by:

$$p_a = p_a^* x_a$$

In this equation,  $p_a$  is the vapor pressure of component 'a' at the prevailing temperature. So, if all of the components are miscible in the liquid phase the total pressure  $P$  of a mixture is:

$$P = p_a^* x_a + p_b^* x_b + p_c^* x_c$$

As a result: (1) the flash point of any flammable liquid will be lowered if it is contaminated with a more volatile, flammable liquid, (2) application of heat to a flammable liquid (e.g., due to radiation or flame impingement in a fire, or because of 'hot work') can generate a flammable vapour-air mixture, (3) an increase in temperature of a toxic liquid can create an excessive concentration of toxic vapor in air which may occur as the result of an exothermic reaction, (4) the pressure in the vapor space of an incompletely full, sealed vessel containing liquid cannot be reduced by partially draining off liquid, (5) the pressure in an incompletely full container of liquid will increase with temperature and can, in the extreme, result in rupture due to over-pressurization unless adequate relief is provided which may occur following an uncontrolled exothermic reaction) or, alternatively, partial ejection of the contents can occur on opening, and (6) the composition of the vapor in equilibrium with a miscible liquid mixture at any temperature, e.g., on heating during distillation, will be enriched by the more volatile components – the composition of the liquid phase produced on partial condensation will be enriched by the less volatile components and such *fractionation* can have implications for safety in that the flammability and relative toxicity of the mixtures can change significantly.



# Viscosity

*Viscosity* is the force in dynes required to move a plane of 1 cm<sup>2</sup> area at a distance of 1 cm from another plane of 1 cm<sup>2</sup> area through a distance of 1 cm in 1 s. In the centimeter-gram-second (cgs) system the unit of viscosity is the poise or centipoise (0.01 P). Two other terms in common use are *kinematic viscosity* and *fluidity*. The kinematic viscosity is the viscosity in centipoises divided by the specific gravity, and the unit is the stoke (cm<sup>2</sup>/s), although centistokes (0.01 cSt; centistoke = centipoise/density) is in more common usage; fluidity is simply the reciprocal of viscosity.

The kinematic viscosity (also called *momentum diffusivity*),  $\eta$ , is the ratio of the dynamic viscosity,  $\mu$ , to the density of the fluid,  $\rho$ :

$$\eta = \mu/\rho$$

When a compressible fluid is compressed or expanded evenly, without shear, it may still exhibit a form of internal friction that resists its flow. These forces are related to the rate of compression or expansion by a factor called the volume viscosity, bulk viscosity or second viscosity. The bulk viscosity is important only when the fluid is being rapidly compressed or expanded.

The viscosity (ASTM D88, ASTM D341, ASTM D445, ASTM D2161, ASTM D2270) of crude oils varies markedly over a very wide range. Values vary from less than 10 cP at room temperature to many thousands of centipoises at the same temperature.

In the early days of the petroleum industry viscosity was regarded as the *body* of petroleum, a significant number for lubricants or for any liquid pumped or handled in quantity. The changes in viscosity with temperature, pressure, and rate of shear are pertinent not only in lubrication but also for such engineering concepts as heat transfer. The viscosity and relative viscosity of different phases, such as gas, liquid oil, and water, are determining influences in producing the flow of reservoir fluids through porous oil-bearing formations. The rate and amount of oil production from a reservoir are often governed by these properties.

Many types of instruments have been proposed for the determination of viscosity. The simplest and most widely used are capillary types (ASTM D445), and the viscosity is derived from the equation:

$$\mu = \pi r^4 P / 8nl$$

where  $r$  is the tube radius,  $l$  the tube length,  $P$  the pressure difference between the ends of a capillary,  $n$  the *coefficient of viscosity*, and the quantity discharged in unit time. Not only are such capillary instruments the simplest, but when designed in accordance with known principle and used with known necessary correction factors, they are probably the most accurate viscometers available. It is usually more convenient, however, to use relative measurements, and for this purpose the instrument is calibrated with an appropriate standard liquid of known viscosity.

Batch flow times are generally used; in other words, the time required for a fixed amount of sample to flow from a reservoir through a capillary is the datum actually observed. Any features of technique that contribute to longer flow times are usually desirable. Some of the principal capillary viscometers in use are those of Cannon-Fenske, Ubbelohde, Fitzsimmons, and Zeitfuchs.

The Saybolt universal viscosity (SUS) (ASTM D88) is the time in seconds required for the flow of 60 ml of petroleum from a container, at constant temperature, through a calibrated orifice. The Saybolt furol viscosity (SFS) (ASTM D88) is determined in a similar manner except that a larger orifice is employed.

As a result of the various methods for viscosity determination, it is not surprising that much effort has been spent on interconversion of the several scales, especially converting Saybolt to kinematic viscosity (ASTM D2161),

$$\text{Kinematic viscosity} = a \times \text{Saybolt s} + b/\text{Saybolt s}$$

where  $a$  and  $b$  are constants.

The Saybolt universal viscosity equivalent to a given kinematic viscosity varies slightly with the temperature at which

the determination is made because the temperature of the calibrated receiving flask used in the Saybolt method is not the same as that of the oil. Conversion factors are used to convert kinematic viscosity from 2 to 70 cSt at 38 °C (100 °F) and 99 °C (210 °F) to the equivalent Saybolt universal viscosity in seconds. Appropriate multipliers are listed to convert kinematic viscosity over 70 cSt. For a kinematic viscosity determined at any other temperature the equivalent Saybolt universal value is calculated by use of the Saybolt equivalent at 38 °C (100 °F) and a multiplier that varies with the temperature:

$$\text{Saybolt s at } 100 \text{ }^\circ\text{F (38 }^\circ\text{C)} = \text{cSt} \times 4.635$$

$$\text{Saybolt s at } 210 \text{ }^\circ\text{F (99 }^\circ\text{C)} = \text{cSt} \times 4.667$$

Various studies have also been made on the effect of temperature on viscosity since the viscosity of petroleum, or a petroleum product, decreases as the temperature increases. The rate of change appears to depend primarily on the nature or composition of the petroleum, but other factors, such as volatility, may also have a minor effect. The effect of temperature on viscosity is generally represented by the equation

$$\log \log (n + c) = A + B \log T$$

where  $n$  is absolute viscosity,  $T$  is temperature, and  $A$  and  $B$  are constants. This equation has been sufficient for most purposes and has come into very general use. The constants  $A$  and  $B$  vary widely with different oils, but  $c$  remains fixed at 0.6 for all oils having a viscosity over 1.5 cSt; it increases only slightly at lower viscosity (0.75 at 0.5 cSt).

The viscosity-temperature characteristics of any oil, so plotted, thus create a straight line, and the parameters  $A$  and  $B$  are equivalent to the intercept and slope of the line. To express the viscosity and viscosity-temperature characteristics of an oil, the slope and the viscosity at one temperature must be known; the usual practice is to select 38 °C (100 °F) and 99 °C (210 °F) as the observation temperatures.

Suitable conversion tables are available (ASTM D341), and each table or chart is constructed in such a way that for any given petroleum or petroleum product the viscosity-temperature points result in a straight line over the applicable temperature range. Thus, only two viscosity measurements need be made at temperatures far enough apart to determine a line on the appropriate chart from which the approximate viscosity at any other temperature can be read. The charts can be applicable only to measurements made in the temperature range in which a given petroleum oil is a Newtonian liquid. The oil may cease to be a simple liquid near the cloud point because of the formation of wax particles or, near the boiling point, because of vaporization. However, the charts do not give accurate results when either the cloud point or boiling point is approached but they are useful over the Newtonian range for estimating the temperature at which oil attains a desired viscosity.

Since the viscosity-temperature coefficient of lubricating oil is an important expression of its suitability, a convenient

number to express this property is very useful, and hence, a viscosity index (ASTM D2270) was derived. It is established that naphthenic oils have higher viscosity-temperature coefficients than do paraffinic oils at equal viscosity and temperatures. The Dean and Davis scale was based on the assignment of a zero value to a typical naphthenic crude oil and that of 100 to a typical paraffinic crude oil; intermediate oils were rated by the formula:

$$\text{Viscosity index} = (L - U)/(L - H \times 100)$$

where  $L$  and  $H$  are the viscosities of the zero and 100 index reference oils, both having the same viscosity at 99 °C (210 °F), and  $U$  is that of the unknown, all at 38 °C (100 °F).

The viscosity of petroleum fractions increases on the application of pressure, and this increase may be very large. The pressure coefficient of viscosity correlates with the temperature coefficient, even when oils of widely different types are compared. A plot of the logarithm of the kinematic viscosity against pressure for several oils has given reasonably linear results up to about 20,000 psi, and the slopes of the isotherms are such that extrapolated values for a given oil intersect. At higher pressures the viscosity decreases with increasing temperature, as at atmospheric pressure; in fact, viscosity changes of small magnitude are usually proportional to density changes, whether these are caused by pressure or by temperature.

The classification of lubricating oil by viscosity is a matter of some importance. A useful system is that of the Society of Automotive Engineers (SAE). Each oil class carries an index designation. For those classes designated by letter and number, maximum viscosity and minimum viscosity are specified at -18 °C (0 °F); those designated by number only are specified in viscosity at 99 °C (210 °F). Viscosity is also used in specifying several grades of fuel oils and in setting the requirement for kerosene and insulating oil.

The viscosity of natural gas is usually several orders of magnitude lower than oil or water. This makes gas much more mobile in the reservoir than either oil or water. Reliable correlation charts are available to estimate gas viscosity and the viscosity of gas mixtures at one atmosphere and reservoir temperature can be determined from the gas mixture composition:

$$\mu_{ga} = \frac{\sum_{i=1}^N y_i \mu_i \sqrt{M_{gi}}}{\sum_{i=1}^N y_i \sqrt{M_{gi}}}$$

$\mu_{ga}$  is the viscosity of the gas mixture at the desired temperature and atmospheric pressure,  $y_i$  is the mole fraction of the  $i$ th component,  $\mu_{gi}$  is the viscosity of the  $i$ th component of the gas mixture at the desired temperature and atmospheric pressure,  $M_{gi}$  is the molecular weight of the  $i$ th component of the gas mixture, and  $N$  is the number of components in the gas mixture. This viscosity is then multiplied by the viscosity ratio to obtain the viscosity at reservoir temperature and pressure.

Table Viscosity Conversion.

Centistokes	Saybolt universal viscosity at			Redwood seconds at			Engler degrees at all temps.
	100 °F.	130 °F.	210 °F.	70 °F.	140 °F.	200 °F.	
2.0	32.62	32.68	32.85	30.2	31.0	31.2	1.14
3.0	36.03	36.10	36.28	32.7	33.5	33.7	1.22
4.0	39.14	39.22	39.41	35.3	36.0	36.3	1.31
5.0	42.35	42.43	42.65	37.9	38.5	38.9	1.40
6.0	45.56	45.65	45.88	40.5	41.0	41.5	1.48
7.0	48.77	48.86	49.11	43.2	43.7	44.2	1.56
8.0	52.09	52.19	52.45	46.0	46.4	46.9	1.65
9.0	55.50	55.61	55.89	48.9	49.1	49.7	1.75
10.0	58.91	59.02	59.32	51.7	52.0	52.6	1.84
11.0	62.43	62.55	62.86	54.8	55.0	55.6	1.93
12.0	66.04	66.17	66.50	57.9	58.1	58.8	2.02
14.0	73.57	73.71	74.09	64.4	64.6	65.3	2.22
16.0	81.30	81.46	81.87	71.0	71.4	72.2	2.43
18.0	89.44	89.61	90.06	77.9	78.5	79.4	2.64
20.0	97.77	97.96	98.45	85.0	85.8	86.9	2.87
22.0	106.4	106.6	107.1	92.4	93.3	94.5	3.10
24.0	115.0	115.2	115.8	99.9	100.9	102.2	3.34
26.0	123.7	123.9	124.5	107.5	108.6	110.0	3.58
28.0	132.5	132.8	133.4	115.3	116.5	118.0	3.82
30.0	141.3	141.6	142.3	123.1	124.4	126.0	4.07
32.0	150.2	150.5	151.2	131.0	132.3	134.1	4.32
34.0	159.2	159.5	160.3	138.9	140.2	142.2	4.57
36.0	168.2	168.5	169.4	146.9	148.2	150.3	4.83
38.0	177.3	177.6	178.5	155.0	156.2	158.3	5.08
40.0	186.3	186.7	187.6	163.0	164.3	166.7	5.34
42.0	195.3	195.7	196.7	171.0	172.3	175.0	5.59
44.0	204.4	204.8	205.9	179.1	180.4	183.3	5.85
46.0	213.7	214.1	215.2	187.1	188.5	191.7	6.11
48.0	222.9	223.3	224.5	195.2	196.6	200.0	6.37
50.0	232.1	232.5	233.8	203.3	204.7	208.3	6.63
60.0	278.3	278.8	280.2	243.5	245.3	250.0	7.90
70.0	324.4	325.0	326.7	283.9	286.0	291.7	9.21
80.0	370.8	371.5	373.4	323.9	326.6	333.4	10.53
90.0	417.1	417.9	420.0	364.4	367.4	375.0	11.84
100.0*	463.5	464.4	466.7	404.9	408.2	416.7	13.16

\*At higher values use the same ratio as above for 100 centistokes; e.g., 102 centistokes = 102 × 4.635 Saybolt seconds at 100 °F. To obtain the Saybolt Universal viscosity equivalent to a kinematic viscosity determined at t °F, multiply the equivalent Saybolt Universal viscosity at 100 °F, by 1 + (t - 100) 0.000064; e.g., 10 centistokes at 210 °F are equivalent to 58.91 × 1.0070, or 59.32 Saybolt Universal Viscosity at 210 °F.





# Viscosity Index

The *viscosity index* is an arbitrary scale used to show the magnitude of viscosity changes in lubricating oils with changes in temperature. The Dean and Davis scale was based on the assignment of a zero value to a typical naphthenic crude oil and that of 100 to a typical paraffinic crude oil; intermediate oils were rated by the formula:

$$\text{Viscosity index} = (L - U)/(L - H \times 100)$$

In this equation,  $L$  is the viscosity of the zero index reference oil,  $H$  is the viscosity of the 100 index reference oils, both having the same viscosity at 99 °C (210 °F), and  $U$  is the viscosity of the unknown oil, all at 38 °C (100 °F). Naphthene-base oil tends to have a higher viscosity-temperature coefficient than paraffin-base oil at equal viscosity and temperatures.

The viscosity of liquids decreases as temperature increases and the viscosity of lubricating oil is closely related to its ability to reduce friction. Generally, the thinnest lubricating oil which still forces the two moving surfaces apart is preferred. If the lubricating oil is too thick, it will require a lot of energy to move the surfaces, whereas if the oil is too thin, the surfaces will rub and friction will increase.

The viscosity index is an indicator of the change in viscosity of lubricating oil with temperature. Automotive lubricants must reduce friction between engine components when it is started from cold (relative to engine operating temperatures) as well as when it is running (up to 200 °C). The best oil (with the highest viscosity index) will not change much in viscosity over such a temperature range and therefore will perform well throughout.



# Viscosity of Petroleum Fractions

The following equations can be used to calculate the liquid viscosity of petroleum fractions at atmospheric pressure and at temperatures of 37.8 °C (100 °F) and 98.9 °C (210 °F):

$$\log \nu_{210} = -0.463634 - 0.166532(\text{API}) + 5.13447 \times 10^{-4}(\text{API})^2 a$$

$$- 8.48995 \times 10^{-3} K(\text{API})$$

$$+ \frac{8.0325 \times 10^{-2} K + 1.24899(\text{API}) + 0.197680(\text{API})^2}{\text{API} + 26.786 - 2.6296K}$$

$$\log \nu_{100} = 4.39371 - 1.94733K + 0.127690K^2$$

$$+ 3.2629 \times 10^{-4}(\text{API})^2$$

$$- 1.18246 \times 10^{-2} K(\text{API})$$

$$\frac{0.17161K^2 + 10.9943(\text{API}) + 9.50663 \times 10^{-2}(\text{API})^2 - 0.860218K(\text{API})}{\text{API} + 50.3642 - 4.78231K}$$

$\nu_{100}$  and  $\nu_{210}$  are the kinematic viscosities at 100 °F and 210 °F in centistokes.



# Viscosity-Gravity Constant

The *viscosity-gravity constant* (VGC) is an index of the chemical composition of crude oil defined by the general relation between specific gravity, sg, at 60 °F and Saybolt Universal viscosity, SUV, at 100 °F:

$$a = 10\text{sg} - 1.0752 \log (\text{SUV} - 38)/10\text{sg} - \log (\text{SUV} - 38)$$

The *viscosity-gravity constant* (*vgc*) was one of the early indices proposed to classify petroleum on the basis of composition. It is particularly valuable for indicating a predominantly paraffinic or naphthenic composition. The constant is based on the differences between the density and specific gravity for the various hydrocarbon species:

$$vgc = [10d - 1.0752 \log(v-380)]/[10 - \log(v-38)]$$

*d* is the specific gravity and *v* is the Saybolt viscosity at 38 °C (100 °F). For viscous crude oils (and viscous products)

where the viscosity is difficult to measure at low temperature, the viscosity at 99 °C (210 °F) can be used:

$$vgc = [d - 0.24 - 0.022 \log(v-35.5)]/0.755$$

In both cases, the lower the index number is indicative of a more paraffinic sample. For example, a paraffinic sample may have a *vgc* on the order of 0.840 whilst the corresponding naphthenic sample may have an index on the order of 0.876.

The obvious disadvantage is the closeness of the indices, almost analogous to comparing crude oil character by specific gravity only where most crude oils fall into the range *d* = 0.800–1.000. The API gravity expanded this scale from 5 – 60 thereby adding more meaning to the use of specific gravity data.



# Volume Flow Rate

The volume flow rate,  $Q$ , of a fluid is the volume of fluid that is passing through a given cross sectional area per unit time. The term *cross sectional area* refers to the area through which the fluid is flowing, such as the circular area inside a pipe. Thus:

$$Q = V/t$$

$V$  is the volume of fluid in a given time,  $t$ . In SI units (International System of Units), the volume flow rate has units of cubic meters per second ( $\text{m}^3/\text{s}$ ).





# Volumetric Evaluation

*Volumetric methods* of resource evaluation attempt to determine the amount of oil-in-place by using the size of the reservoir as well as the physical properties of its rocks and fluids. Then a recovery factor is assumed, using assumptions from fields with similar characteristics. The amount of oil in place is multiplied by the recovery factor to arrive at a reserve

number. Current recovery factors for oil fields around the world typically range between 10 and 60% v/v and may be as high as 80% v/v. The wide variance is due largely to the diversity of fluid and reservoir characteristics for different deposits. The method is most useful early in the life of the reservoir, before significant production has occurred.



## Volumetric Factors

The conditions prevailing at the reservoir when compared to the conditions at the surface result in one barrel of fluid at reservoir conditions containing a different amount of matter as one barrel of fluid at surface conditions. Volumetric factors readily relate the *volume* of fluids that are obtained at the surface (stock tank) to the volume that the fluid actually occupied when it was compressed in the reservoir. The oil formation volume factor can be defined as the volume of reservoir fluid required to produce one barrel of oil in the stock tank.

For example, the volume that a *live oil* occupies at the reservoir is *more* than the volume of oil that leaves the stock tank at the surface which is a result of the evolution of gas from oil as pressure decreases from reservoir pressure to surface pressure. If an oil has no gas in solution (*dead oil*), the volume that it would occupy at reservoir conditions is less than the volume that it occupies at the surface. In this case, only liquid compressibility plays a role in the change of volume.

The formation volume factor of a natural gas ( $B_g$ ) relates the volume of 1 lb mol of gas at reservoir conditions to the volume of the same lb mol of gas at standard conditions:

$$B_g = \frac{\text{Volume of 1 lbmol of gas at reservoir conditions, RCF}}{\text{Volume of 1 lbmol gas at standard conditions, SCF}}$$

The formation volume factor of a crude oil or gas condensate ( $B_o$ ) relates the volume of 1 lb mol of liquid at reservoir conditions to the volume of that liquid once it has gone through the surface separation facility. Thus:

$$B_o = \frac{\text{Volume of 1 lbmol of liquid at reservoir conditions, RB}}{\text{Volume of that lbmol after going through separation, STB}}$$

The total volume occupied by 1 lb mol of liquid at reservoir conditions ( $(V_o)_{res}$ ) can be calculated through the compressibility factor of that liquid:

$$(V_o)_{res} = \left( \frac{nZ_o RT}{P} \right)_{res}$$

where  $n = 1$  lb mol

Upon separation, some gas is going to be taken out of the liquid stream feeding the surface facility. If  $n_{st}$  is the number of the moles of liquid leaving the stock tank per mole of feed entering the separation facility, the volume that 1 lb mol of reservoir liquid is going to occupy after going through the separation facility is:

$$(V_o)_{res} = \left( \frac{n_{st} Z_o RT}{P} \right)_{sc}$$

This assumes that at the last stage of separation, the stock tank operates at standard conditions. Thus:

$$B_o = \frac{\left( \frac{nZ_o RT}{P} \right)_{res}}{\left( \frac{n_{st} Z_o RT}{P} \right)_{sc}}$$

or,

$$B_o = \frac{1}{n_{st}} \frac{(Z_o)_{res}}{(Z_o)_{sc}} \frac{T_{sc}}{T_{res}} \frac{P_{sc}}{P_{res}} [RB/STB]$$

$(Z_o)_{sc}$ , unlike  $Z_{sc}$  for a gas, is never equal to one.



# Water – Boiling Point Variation with Pressure

**Table** Boiling Point Variation of Water.

psia	Boiling point, °F	psia	Boiling point, °F	psia	Boiling point, °F
0.5	79.6	44	273.1	150	358.5
1	101.7	46	275.8	175	371.8
2	126	48	278.5	200	381.9
3	141.4	50	281	225	391.9
4	125.9	52	283.5	250	401
5	162.2	54	285.9	275	409.5
6	170	56	288.3	300	417.4
7	176.8	58	290.5	325	424.8
8	182.8	60	292.7	350	431.8
9	188.3	62	294.9	375	438.4
10	193.2	64	297	400	444.7
11	197.7	66	299	425	450.7
12	201.9	68	301	450	456.4
13	205.9	70	303	475	461.9
14	209.6	72	304.9	500	467.1
14.69	212	74	306.7	525	472.2
15	213	76	308.5	550	477.1
16	216.3	78	310.3	575	481.8
17	219.4	80	312.1	600	486.3
18	222.4	82	313.8	625	490.7
19	225.2	84	315.5	650	495
20	228	86	317.1	675	499.2
22	233	88	318.7	700	503.2
24	237.8	90	320.3	725	507.2

(Continued)

Table Cont.

<b>psia</b>	<b>Boiling point, °F</b>	<b>psia</b>	<b>Boiling point, °F</b>	<b>psia</b>	<b>Boiling point, °F</b>
26	242.3	92	321.9	750	511
28	246.4	94	323.4	775	514.7
30	250.3	96	324.9	800	518.4
32	254.1	98	326.4	825	521.9
34	257.6	100	327.9	850	525.4
36	261	105	331.4	875	528.8
38	264.2	110	334.8	900	532.1
40	267.3	115	338.1	950	538.6
42	270.2	120	341.3	1000	544.8

# Water – Common Impurities

**Table** Common Impurities in Water.

Constituent	Chemical Formula	Difficulties Caused	Means of Treatment
Turbidity	None, usually expressed in Jackson Turbidity Units	Imparts unsightly appearance to water; deposits in water lines, process equipment, boilers, etc.; interferes with most process uses	Coagulation, settling, and filtration
Color	None	Decaying organic material and metallic ions causing color may cause foaming in boilers; hinders precipitation methods such as iron removal, hot phosphate softening; can stain product in process use	Coagulation, filtration, chlorination, adsorption by activated carbon
Hardness	Calcium, magnesium, barium and strontium salts expressed as CaCO <sub>3</sub>	Chief source of scale in heat exchange equipment, boilers, pipe lines, etc.; forms curds with soap; interferes with dyeing, etc.	Softening, distillation, internal boiler water treatment, surface active agents, reverse osmosis, electro dialysis
Alkalinity	Bicarbonate (HCO <sub>3</sub> <sup>-1</sup> ), carbonate (CO <sub>3</sub> <sup>-2</sup> ), and hydroxyl (OH <sup>-1</sup> ), expressed as CaCO <sub>3</sub>	Foaming and carryover of solids with steam; embrittlement of boiler steel; bicarbonate and carbonate produce CO <sub>2</sub> in steam, a source of corrosion	Lime and lime-soda softening, acid treatment, hydrogen zeolite softening, demineralization, dealkalization by anion exchange, distillation, degasifying
Free Mineral Acid	H <sub>2</sub> SO <sub>4</sub> , HCl, etc. expressed as CaCO <sub>3</sub> , titrated to methyl orange end-point	Corrosion	Neutralization with alkalis
Carbon Dioxide	CO <sub>2</sub>	Corrosion in water lines and particularly steam and condensate lines	Aeration, decoration, neutralization with alkalis, filming and neutralizing amines
pH	Hydrogen Ion concentration defined as $pH = \log \frac{1}{(H^{-1})}$	pH varies according to acidic or alkaline solids in water; most natural waters have a pH of 6.0–8.0	pH can be increased by alkalis and decreased by acids
Sulfate	(SO <sub>4</sub> ) <sup>-2</sup>	Adds to solids content of water, but, in itself, is not usually significant; combines with calcium to form calcium sulfate scale	Demineralization, distillation, reverse osmosis, electro dialysis

(Continued)

Table Cont.

Constituent	Chemical Formula	Difficulties Caused	Means of Treatment
Chloride	Cl <sup>-1</sup>	Adds to solids content and increases corrosive character of water	Demineralization, distillation, reverse osmosis, electro dialysis
Nitrate	(NO <sub>3</sub> ) <sup>-1</sup>	Adds to solids content, but is not usually significant industrially; useful for control of boiler metal embrittlement	Demineralization, distillation, reverse osmosis, electro dialysis
Fluoride	F <sup>-1</sup>	Not usually significant industrially	Adsorption with magnesium hydroxide, calcium phosphate, or bone black; Alum coagulation; reverse osmosis; electro dialysis
Silica	SiO <sub>2</sub>	Scale in boilers and cooling water systems; insoluble turbine blade deposits due to silica vaporization	Hot process removal with magnesium salts; adsorption by highly basic anion exchange resins, in conjunction with demineralization; distillation
Iron	Fe <sup>+2</sup> (ferrous) Fe <sup>+3</sup> (ferric)	Discolors water on precipitation; source of deposits in water lines, boilers, etc.; interferes with dyeing, tanning, paper mfr., etc.	Aeration, coagulation and titration, lime softening, cation exchange, contact filtration, surface active agents for iron retention
Manganese	Mn <sup>+2</sup>	same as iron	same as iron
Oil	Expressed as oil or chloroform extractable matter, ppmw	Scale, sludge and foaming in boilers; impedes heat exchange; undesirable in most processes	Baffle separators, strainers, coagulation and filtration, distomaceous earth filtration
Oxygen	O <sub>2</sub>	Corrosion of water lines, heat exchange equipment, boilers, return lines, etc.	Deaeration, sodium sulfite, corrosion inhibitors, hydrazine or suitable substitutes
Hydrogen Sulfide	H <sub>2</sub> S	Cause of "rotten egg" odor; corrosion	Aeration, chlorination, highly basic anion exchange
Ammonia	NH <sub>3</sub>	Corrosion of copper and zinc alloys by formation of complex soluble ion	Cation exchange with hydrogen zeolite, chlorination, deaeration, mixed-bed demineralization
Conductivity	Expressed as micromhos, specific conductance	Conductivity is the result of ionizable solids in solution; high conductivity can increase the corrosive characteristics of a water	Any process which decreases dissolved solids content will decrease conductivity; examples are demineralization, lime softening
Dissolved Solids	None	"Dissolved solids" is measure of total amount of dissolved matter, determined by evaporation; high concentrations of dissolved solids are objectionable because of process interference and as a cause of foaming in boilers	Various softening processes, such as lime softening and cation exchange by hydrogen zeolite, will reduce dissolved, solids; demineralization; distillation; reverse osmosis; electro dialysis
Suspended Solids	None	"Suspended Solids" is the measure of un-dissolved matter, determined gravimetrically; suspended solids plug lines, cause deposits in heat exchange equipment, boilers, etc.	Subsidence, filtration, usually preceded by coagulation and setting



# Water – Density and Viscosity in Relation to Temperature

**Table** Temperature Variation of the Density and Viscosity of Water.

T, °C	Density,	Viscosity,
	kgm/cubic meter	mPa
0	1000	1.788
10	1000	1.307
20	998	1.003
30	996	0.799
40	992	0.657

T, °C	Density,	Viscosity,
	kgm/cubic meter	mPa
50	988	0.548
60	983	0.467
70	978	0.405
80	972	0.355
90	965	0.316
100	958	0.283



# Water Saturation

Water saturation ( $S_w$ ) is used to quantify its more important complement, the hydrocarbon saturation ( $1-S_w$ ). Complexities arise because there are a number of independent approaches that can be used to calculate  $S_w$ . The complication is that often, if not typically, these different approaches lead to somewhat different  $S_w$  values that may equate to considerable differences in the original oil in place (OOIP) or original gas in place (OGIP) volumes.

The techniques for calculating water saturation  $S_w$  in wellbores include: (1)  $S_w$  calculations from resistivity

well logs by application of a model relating  $S_w$  to porosity, connate-water resistivity, and various rock electrical properties, (2)  $S_w$  calculations from laboratory capillary pressure/saturation,  $P_c/S_w$ , measurements by application of a model relating  $S_w$  to various rock and fluid properties and height above the free-water level, (3)  $S_w$  calculations using oil-based mud (OBM)-core-plug Dean-Stark water-volume determinations, and (4) any combinations of these methods.



# Watson Characterization Factor

The *Watson characterization factor* is the best known and most frequently used characterization factor and is based on the density diagram versus the boiling point of the various types of hydrocarbons. This enables proposing a function between density and temperature dividing the diagram in distinct areas according to hydrocarbon type. The characterization factor ( $k_w$ ) can be derived based on this function.

$$k_w = \frac{PEMC^{1/3}}{d_{15.6/15.6}}$$

*PEMC*: average cubic boiling point in R, determined by the Watson method;

$d_{15.6/15.6}$ : density at 15.6/15.6 °C;

$k_w$ : Watson characterization factor.

The following interpretations of the characterization factor have been suggested as a guide to crude oil character and/or feedstock character:

- $k_w > 13$ : Short chain paraffins.
- $12 > k_w > 13$ : Medium to long chain paraffins and long paraffinic chain alkyl-naphthenes.
- $11 > k_w > 12$ : Pure naphthenes, medium paraffin chain alkyl-naphthenes and long paraffin chain alkyl-aromatics
- $10 > k_w > 11$ : Pure, condensed and conjugate naphthenes and medium paraffin chain alkyl-aromatics.
- $9 > k_w > 10$ : Pure aromatics, condensed and naphthene-aromatics.



# Weights and Measures – Density

**Table** Density of Various Petroleum Products and Materials.

<i>Substance</i>	<i>Density</i>	<i>Density</i>
	<i>SI</i>	<i>US</i>
<i>Fuels</i>		
Crude Oil	874 kg/m <sup>3</sup>	7.3 lb/gal
Residual Oil	944 kg/m <sup>3</sup>	7.88 lb/gal
Distillate Oil	845 kg/m <sup>3</sup>	7.05 lb/gal
Gasoline	739 kg/m <sup>3</sup>	6.17 lb/gal
Natural Gas	673 kg/m <sup>3</sup>	1 lb/23.8 ft <sup>3</sup>
Butane	579 kg/m <sup>3</sup>	4.84 lb/gal (liquid)
Propane	507 kg/m <sup>3</sup>	4.24 lb/gal (liquid)
<i>Mineral Products</i>		
Brick	2.95 kg/brick	6.5 lb/brick
Cement	170 kg/bbl	375 lb/bbl
Cement	1483 kg/m <sup>3</sup>	2500 lb/yd <sup>3</sup>
Concrete	2373 kg/m <sup>3</sup>	4000 lb/yd <sup>3</sup>
Glass, Common	2595 kg/m <sup>3</sup>	162 lb/ft <sup>3</sup>
Gravel, Dry Packed	1600–1920 kg/m <sup>3</sup>	100–120 lb/ft <sup>3</sup>
Gravel, Wet	2020 kg/m <sup>3</sup>	126 lb/ft <sup>3</sup>
Gypsum, Calcined	880–960 kg/m <sup>3</sup>	55–60 lb/ft <sup>3</sup>
Lime, Pebble	850–1025 kg/m <sup>3</sup>	53–64 lb/ft <sup>3</sup>
Sand, Gravel (Dry, loose)	1440–1680 kg/m <sup>3</sup>	90–105 lb/ft <sup>3</sup>





# Weights and Measures – Fuels

**Table** Properties of Various Fuels.

<i>Type of Fuel</i>	<i>Heating Value</i>		<i>Sulfur</i>	<i>Ash</i>
	<i>Kcal</i>	<i>Btu</i>	<i>% w/w</i>	<i>% w/w</i>
<b>Solid Fuels</b>				
Coke	7,380/kg	13,300/lb	0.5–1.0	0.5–5.0
<b>Liquid Fuels</b>				
Residual Oil	$9.98 \times 10^6/\text{m}^3$	150,000/gal	0.5–4.0	0.05–0.1
Distillate Oil	$9.30 \times 10^6/\text{m}^3$	140,000/gal	0.2–1.0	N
Diesel	$9.12 \times 10^6/\text{m}^3$	137,000/gal	0.4	N
Gasoline	$8.62 \times 10^6/\text{m}^3$	130,000/gal	0.03–0.04	N
Kerosene	$8.32 \times 10^6/\text{m}^3$	135,000/gal	0.02–0.05	N
Liquid Petroleum Gas	$6.25 \times 10^6/\text{m}^3$	94,000/gal	N	N
<b>Gaseous Fuels</b>				
Natural Gas	9,341/ $\text{m}^3$	1,050/scf	N	N

a N = negligible.

b Ash content may be considerably higher when sand, dirt, etc., are present.



## Weights and Measures - General

<i>Unit of measure</i>	<i>Equivalent</i>
Grain	0.002 ounces
Gram	0.04 ounces
Ounce	28.35 grams
Kilogram	2.21 pounds
Pound	0.45 kilograms
pound (troy)	12 ounces
ton (short)	2000 pounds
ton (long)	2240 pounds
ton (metric)	2200 pounds
ton (shipping)	40 feet <sup>3</sup>
centimeter	0.39 inches
inch	2.54 centimeters
foot	30.48 centimeters
meter	1.09 yards
yard	0.91 meters
mile	1.61 kilometers
centimeter <sup>2</sup>	0.16 inches <sup>2</sup>
inch <sup>2</sup>	6.45 centimeters <sup>2</sup>
foot <sup>2</sup>	0.09 meters <sup>2</sup>

<i>Unit of measure</i>	<i>Equivalent</i>
meter <sup>2</sup>	1.2 yards <sup>2</sup>
yard <sup>2</sup>	0.84 meters <sup>2</sup>
mile <sup>2</sup>	2.59 kilometers <sup>2</sup>
centimeter <sup>3</sup>	0.061 inches <sup>3</sup>
inch <sup>3</sup>	16.39 centimeters <sup>3</sup>
foot <sup>3</sup>	283.17 centimeters <sup>3</sup>
foot <sup>3</sup>	1728 inches <sup>3</sup>
meter <sup>3</sup>	1.31 yards <sup>3</sup>
yard <sup>3</sup>	0.77 meters <sup>3</sup>
cord	128 feet <sup>3</sup>
cord	4 meters <sup>3</sup>
peck	8 quarts
bushel (dry)	4 pecks
bushel	2150.4 inches <sup>3</sup>
gallon (US)	231 inches <sup>3</sup>
barrel	31.5 gallons
hogshead	2 barrels
township	36 miles <sup>2</sup>
hectare	2.5 acres



# Well Casing

Casing that is cemented in place aids the drilling process in several ways: (1) prevents contamination of fresh water well zones, (2) prevents unstable upper formations from caving in and sticking the drill string or forming large caverns, (3) provides a strong upper foundation to use high-density drilling fluid to continue drilling deeper, (4) isolates different zones, that may have different pressures or fluids – zonal isolation – in the drilled formations from one another, (5) seals off high-pressure zones from the surface, avoiding potential for a blowout, (6) prevents fluid loss into or contamination of production zones, and (7) provides a smooth internal bore for installing production equipment. A slightly different metal string (the production tubing) may be used without cement in the smallest casing of a well completion to contain production fluids and convey them to the surface from an underground reservoir.

In the planning stages of a well, a drilling engineer, usually with input from geologists, will choose strategic depths at which the hole will need to be cased in order for drilling to reach the desired total depth. This decision is often based on subsurface data such as formation pressures, strengths, and makeup, and is balanced against the cost objectives and desired drilling strategy. With the casing set depths determined, hole sizes and casing sizes must follow.

The hole drilled for each casing string must be large enough to easily fit the casing inside it, allowing room for cement between the outside of the casing and the hole. Also, the inside diameter of the first casing string must be large enough to fit the second bit that will continue drilling. Thus, each casing string will have a subsequently smaller diameter. The inside diameter of the final casing string (or penultimate one in some instances of a liner completion) must accommodate the production tubing and associated hardware such as packers, gas lift mandrels and subsurface safety valves.

Typically, a well contains multiple intervals of casing successively placed within the previous casing run. Thus, the structure of the casing in the well is not merely the well hole with the casing inside but the protocol requires a series of actions to ensure the correct insertion of the casing. From the outermost part of the casing to the innermost production casing, the structure of the casing is:

1. Cemented to surface
2. Conductor casing
3. Cemented to surface
4. Surface casing
5. Drilling mud
6. Cement
7. Intermediate casing
8. Drilling mud
9. Production casing

The conductor casing serves as a support during drilling operations, to flowback returns during drilling and cementing of the surface casing, and to prevent collapse of the loose soil near the surface. It can normally vary from sizes such as 18 inches to 30 inches. The purpose of surface casing is to isolate freshwater zones so that they are not contaminated during drilling and completion. Surface casing is the most strictly regulated due to these environmental concerns, which can include regulation of casing depth and cement quality. A typical size of surface casing is 13 $\frac{3}{8}$  inches.

Intermediate casing may be necessary on longer drilling intervals where necessary drilling mud weight to prevent blowouts may cause a hydrostatic pressure that can fracture shallower or deeper formations. Casing placement is selected so that the hydrostatic pressure of the drilling fluid remains at a pressure level that is between formation pore pressures and fracture pressures.

Cementing is performed by circulating a cement slurry through the inside of the casing and out into the annulus through the casing shoe at the bottom of the casing string. In order to precisely place the cement slurry at a required interval on the outside of the casing, a plug is pumped with a displacement fluid behind the cement slurry column, which

“bumps” in the casing shoe and prevents further flow of fluid through the shoe. This bump can be seen at surface as a pressure spike at the cement pump. To prevent the cement from flowing back into the inside of the casing, a float collar above the casing shoe acts as a check valve and prevents fluid from flowing up through the shoe from the annulus.

# Wellbore Stability Analysis

Analysis of wellbore stability requires assessment of the rock's competence and its potential for failure, resulting in (1) wellbore collapse, (2) unwanted hydraulic fracturing, (3) wellbore breakouts, (4) sand production, and (5) perforation collapse. The mechanical behavior of relevant rock samples is investigated in the laboratory, under simulated *in situ* conditions of stress and temperature, to assess the potential for failure.

Recommended mechanical tests to assess rock competence and susceptibility to failure include: unconfined compression (UCS) testing, triaxial compression testing (TCS), multistage triaxial compression testing, thick-walled cylinder collapse testing, Brazilian tensile strength testing, and concurrent measurement of ultrasonic velocities.





# Wettability

The term *wettability* refers to the tendency of one fluid to spread on or adhere to a solid surface in the presence of other immiscible fluids (Figure). Wettability of a solid with respect to two phases is characterized by the contact angle. Terminology for saturation changes in porous media reflects wettability are (1) drainage, which refers to the decreasing saturation of a wetting phase, and (2) imbibition, which refers to the increasing wetting-phase saturation.

The tendency of a liquid to spread over the surface of a solid is an indication of the *wetting* characteristics of the liquid for the solid. This spreading tendency can be expressed more conveniently by measuring the angle of contact at the *liquid-solid* surface. This angle, which is always measured through the liquid to the solid, is the contact angle  $\theta$ .

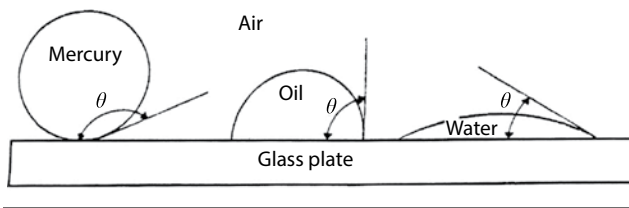

**Figure** Illustration of Wettability.

The contact angle has achieved significance as a measure of wettability – as the contact angle decreases, the wetting characteristics of the liquid increase. Complete wettability would be evidenced by a zero contact angle, and complete non-wetting would be evidenced by a contact angle of  $180^\circ$ . There have been various definitions of *intermediate* wettability but, in much of the published literature, contact angles of  $60^\circ$  to  $90^\circ$  will tend to repel the liquid.

The wettability of reservoir rocks in response to contact with the reservoir fluids is an important aspect of the distribution of the fluids in the porous media is a function of wettability. Because of the attractive forces, the wetting phase tends to occupy the smaller pores of the rock and the non-wetting phase occupies the more open channels.

With increasing oil wetness, the capillary pressure shifts upward, reflecting the increased pressure needed to push water into the pore spaces of the specimen.

- When strongly water-wet,  $S_{or}$  is approximately 14%.
- When intermediate-wet,  $S_{or}$  rises to approximately 35%.
- When strongly oil-wet,  $S_{or}$  returns to approximately 15%.



# Wobbe Index

The *Wobbe Index* (*Wobbe number*) is a number which represents the properties of natural gas and is the calorific value of a gas divided by the specific gravity. The Wobbe Index (WI or *Wobbe number*, WN) is an indicator of the interchangeability of fuel gases such as natural gas, liquefied petroleum gas (LPG), and coal gas. It is frequently defined in the specifications of gas supply and transport utilities.

The Wobbe Index,  $I_w$ , is the relationship between the higher heating value and the square root of gas specific gravity:

$$I_w = \frac{V_c}{\sqrt{G_s}}$$

$V_c$  is the higher heating value, or calorific value, and  $G_s$  is the specific gravity.

The *higher heating value* (HHV; also known as the *gross calorific value* or *gross energy*) of a fuel is the amount of heat released during combustion by a specified quantity (initially at 25 °C) and the products have returned to a temperature of 25 °C. The *higher heating value* takes into account the latent heat of vaporization of water in the combustion products, and is useful in calculating heating values for fuels where condensation of the reaction products is practical (e.g., in a gas-fired boiler used for space heat) and assumes all the water component is in liquid state at the end of combustion (in product of combustion).

The *lower heating value* (*net calorific value*, *net CV*, or *LHV*) of a fuel is defined as the amount of heat released by combusting a specified quantity (initially at 25 °C or another reference state) and returning the temperature of the combustion products to 150 °C.

The *lower heating value* assumes all the water component is in vapor state at the end of combustion (in product

of combustion), as opposed to higher heating value which assumes the entire water component in liquid form of the combustion gas. The lower heating value assumes that the latent heat of vaporization of water in the fuel and the reaction products is not recovered. It is useful in comparing fuels where condensation of the combustion products is impractical, or heat at a temperature below 150 °C cannot be put to use.

The Wobbe Index (Table) is used to compare the combustion energy output of different composition fuel gases in an appliance (fire, cooker etc.). If two fuels have identical Wobbe Indices then for given pressure and valve settings the energy output will also be identical. Typically, variations of up to 5% are allowed as these would not be noticeable to the consumer. The Wobbe Index is a critical factor to minimize the impact of the changeover when analyzing the use of synthetic natural gas fuels such as propane-air mixtures. The Wobbe Index is commonly expressed in Btu per standard cubic foot or megajoules per standard cubic meter (1000 BTU/scf = 37.3 MJ/m<sup>3</sup>). In the case of natural gas, the typical heating value is around 1,050 Btu per cubic foot and the specific gravity is approximately 0.59, giving a typical Wobbe Index of 1.367.

**Table** Wobbe Index (kcal/m<sup>3</sup>) ofw Natural Gas and Common Constituents.

Gas	Upper index	Lower index
Natural gas	12,837	11,597
Methane	12,735	11,452
Ethane	16,298	14,931
Propane	19376	17,817
n-Butane	22,066	20,336
iso-Butane	21,980	20,247

There are three ranges or groups of fuel gases that have been internationally agreed based on Wobbe Index:

Group 1 includes manufactured gases.

Group 2 covers natural gas (with high and low ranges).

Group 3 includes liquefied petroleum gas (LPG).

Combustion equipment is typically designed to burn a fuel gas within a particular family: hydrogen-rich town gas, natural gas or liquefied petroleum gas.

Other flame characteristics and composition limits may determine the acceptability of the replacement gas, e.g., flame speed, *yellow tipping* due to incomplete combustion, sulfur content, and oxygen content.

# Working Gas

*Working gas* is the volume of natural gas in the storage reservoir that can be extracted during the normal operation of the storage facility. This is the natural gas that is being stored and withdrawn; the capacity of storage facilities normally refers to their working gas capacity. At the beginning of a withdrawal cycle, the pressure inside the storage facility is at

its highest; meaning working gas can be withdrawn at a high rate. As the volume of gas inside the storage facility drops, pressure (and thus deliverability) in the storage facility also decreases. Periodically, underground storage facility operators may reclassify portions of working gas as base gas after evaluating the operation of their facilities.



# Bibliography and Information Sources

- Abdel-Aal, H.K., Aggour, A.A., and Fahim, M.A. 2016. *Petroleum and Gas Field Processing*, 2<sup>nd</sup> Edition. CRC Press, Taylor & Francis Group, Boca Raton, Florida.
- Ahmed, T. 2006. *Reservoir Engineering Handbook*, 3<sup>rd</sup> Edition. Gulf Professional Publishing, Elsevier, Burlington, Massachusetts.
- ASTM D56. 2016. Standard Test Method for Flash Point by Tag Closed Cup Tester. *Annual Book of Standards*. ASTM International, West Conshohocken, Pennsylvania.
- ASTM D86. 2016. Standard Test Method for Distillation of Petroleum Products and Liquid Fuels at Atmospheric Pressure. *Annual Book of Standards*. ASTM International, West Conshohocken, Pennsylvania.
- ASTM D88. 2016. Standard Test Method for Saybolt Viscosity. *Annual Book of Standards*, ASTM International, West Conshohocken, Pennsylvania.
- ASTM D92. 2016. Standard Test Method for Flash and Fire Points by Cleveland Open Cup Tester. *Annual Book of Standards*. ASTM International, West Conshohocken, Pennsylvania.
- ASTM D93. 2016. Standard Test Methods for Flash Point by Pensky-Martens Closed Cup Tester. *Annual Book of Standards*. ASTM International, West Conshohocken, Pennsylvania.
- ASTM D323. 2016. Standard Test Method for Vapor Pressure of Petroleum Products (Reid Method). *Annual Book of Standards*. ASTM International, West Conshohocken, Pennsylvania.
- ASTM D341. 2016. Standard Practice for Viscosity-Temperature Charts for Liquid Petroleum Products. *Annual Book of Standards*. ASTM International, West Conshohocken, Pennsylvania.
- ASTM D445. 2016. Standard Test Method for Kinematic Viscosity of Transparent and Opaque Liquids (and Calculation of Dynamic Viscosity). *Annual Book of Standards*. ASTM International, West Conshohocken, Pennsylvania.
- ASTM D611. 2016. Standard Test Methods for Aniline Point and Mixed Aniline Point of Petroleum Products and Hydrocarbon Solvents. *Annual Book of Standards*. ASTM International, West Conshohocken, Pennsylvania.
- ASTM D664. 2016. Standard Test Method for Acid and Base Number by Color-Indicator Titration. *Annual Book of Standards*. ASTM International, West Conshohocken, Pennsylvania.
- ASTM D974. 2016. Standard Test Method for Acid and Base Number by Color-Indicator Titration. *Annual Book of Standards*. ASTM International, West Conshohocken, Pennsylvania.
- ASTM D976. 2016. Standard Test Method for Calculated Cetane Index of Distillate Fuels. *Annual Book of Standards*. ASTM International, West Conshohocken, Pennsylvania.
- ASTM D1070. 2016. Standard Test Methods for Relative Density of Gaseous Fuels. *Annual Book of Standards*. ASTM International, West Conshohocken, Pennsylvania.
- ASTM D1250. 2016. Standard Guide for Use of the Petroleum Measurement Tables. *Annual Book of Standards*. ASTM International, West Conshohocken, Pennsylvania.
- ASTM D1310. 2016. Standard Test Method for Flash Point and Fire Point of Liquids by Tag Open-Cup Apparatus. *Annual Book of Standards*. ASTM International, West Conshohocken, Pennsylvania.
- ASTM D1826. 2016. Standard Test Method for Calorific (Heating) Value of Gases in Natural Gas Range by Continuous Recording Calorimeter. *Annual Book of Standards*. ASTM International, West Conshohocken, Pennsylvania.
- ASTM D2161. 2016. Standard Practice for Conversion of Kinematic Viscosity to Saybolt Universal Viscosity or to Saybolt Furoil Viscosity. *Annual Book of Standards*. ASTM International, West Conshohocken, Pennsylvania.

- ASTM D2163. 2016. Standard Test Method for Determination of Hydrocarbons in Liquefied Petroleum (LP) Gases and Propane/Propene Mixtures by Gas Chromatography. *Annual Book of Standards*. ASTM International, West Conshohocken, Pennsylvania.
- ASTM D2270. 2016. Standard Practice for Calculating Viscosity Index from Kinematic Viscosity at 40 °C and 100 °C. *Annual Book of Standards*. ASTM International, West Conshohocken, Pennsylvania.
- ASTM D2650. 2016. Standard Test Method for Chemical Composition of Gases by Mass Spectrometry. *Annual Book of Standards*. ASTM International, West Conshohocken, Pennsylvania.
- ASTM D2699. 2016. Standard Test Method for Research Octane Number of Spark-Ignition Engine Fuel. *Annual Book of Standards*. ASTM International, West Conshohocken, Pennsylvania.
- ASTM D2700. 2016. Standard Test Method for Motor Octane Number of Spark-Ignition Engine Fuel. *Annual Book of Standards*. ASTM International, West Conshohocken, Pennsylvania.
- ASTM D3828. 2016. Standard Test Methods for Flash Point by Small Scale Closed Cup Tester. *Annual Book of Standards*. ASTM International, West Conshohocken, Pennsylvania.
- ASTM D4057. 2016. Standard Practice for Manual Sampling of Petroleum and Petroleum Products. *Annual Book of Standards*. ASTM International, West Conshohocken, Pennsylvania.
- ASTM D4177. 2016. Standard Practice for Automatic Sampling of Petroleum and Petroleum Products. *Annual Book of Standards*. ASTM International, West Conshohocken, Pennsylvania.
- ASTM D4424. 2016. Standard Test Method for Butylene Analysis by Gas Chromatography. *Annual Book of Standards*. ASTM International, West Conshohocken, Pennsylvania.
- ASTM D4737. 2016. Standard Test Method for Calculated Cetane Index by Four Variable Equation. *Annual Book of Standards*. ASTM International, West Conshohocken, Pennsylvania.
- ASTM E659. 2016. Standard Test Method for Autoignition Temperature of Liquid Chemicals. *Annual Book of Standards*. ASTM International, West Conshohocken, Pennsylvania.
- ASTM International. 1997. *Metals Handbook*. American Society for Metals. ASM International, Material Park, Ohio. Chapter 32 (Failure Analysis).
- Avallone, E.A., Baumeister, T. III, and Sadegh, A. 2007. *Marks' Standard Handbook for Mechanical Engineers*, 11<sup>th</sup> Edition. McGraw-Hill Education, New York.
- Bahadori, A. 2014. *Corrosion and Materials Selection: A Guide for the Chemical and Petroleum Industries*. John Wiley & Sons Inc., Hoboken, New Jersey.
- Ballard, A.L. and Sloan Jr., E.D. 2002. The Next Generation of Hydrate Prediction: An Overview. *J. Supramol. Chem.* 2 (4-5): 385-392.
- Boggs, S., Jr. 2011. *Principles of Sedimentology and Stratigraphy*, 5<sup>th</sup> Edition. New Jersey, Prentice Hall, Pearson Education Inc., Upper Saddle River, New Jersey.
- Branan, C.R. (Editor). 2005. *Rules of Thumb for Chemical Engineers: A Manual for Quick, Accurate Solutions to Everyday Process Engineering Problems*, 3<sup>rd</sup> Edition. Gulf Professional Publishing, Elsevier Science, Burlington, Massachusetts.
- Carson, P., and Mumford, C. 2002. *Hazardous Chemicals Handbook*, 2<sup>nd</sup> Edition. Butterworth-Heinemann, Elsevier Science, Oxford, United Kingdom.
- Chadeesingh, R. The Fischer-Tropsch Process. In *The Biofuels Handbook*. J.G. Speight (Editor). The Royal Society of Chemistry, London, United Kingdom. 2011. Part 3, Chapter 5, Pages 476-517.
- Chaudhuri, U.R. 2010. *Fundamentals of Petroleum & Petrochemical Engineering*. CRC Press, Taylor & Francis Group, Boca Raton, Florida.
- Craft, B.C., Hawkins, M.F. and Terry, R.E. 1991. *Applied Petroleum Reservoir Engineering*, 2<sup>nd</sup> Edition. Prentice Hall, Englewood Cliffs, New Jersey.
- Dake, L.P. 1978. *Fundamentals of Reservoir Engineering*. Elsevier, Amsterdam, Netherlands.
- Darton, R. (Editor). 1997. *Distillation and Absorption*. Institution of Chemical Engineers, Rugby, United Kingdom. Volume 2.
- Davis, B.H., and Occelli, M.L. 2010. *Advances in Fischer-Tropsch Synthesis, Catalysts, and Catalysis*. CRC Press, Taylor & Francis Group, Boca Raton, Florida.
- Davis, M.E., and Davis, R.J. 2003. *Fundamentals of Chemical Reaction Engineering*. McGraw-Hill, New York.
- Demirbaş, A. 2010. *Biorefineries: For Biomass Upgrading Facilities*. Springer-Verlag, London, United Kingdom.
- Devold, H. 2013. *Oil and Gas Production Handbook: An Introduction to Oil and Gas Production, Transport, Refining, and Petrochemical Industry*, 3<sup>rd</sup> Edition. ABB Oil and Gas, Oslo, Norway.
- El-Gendy, N.S., and Speight, J.G. *Handbook of Refinery Desulfurization*. CRC Press, Taylor & Francis Group, Boca Raton, Florida.
- Evans, F.L. 1979. *Equipment Design Handbook for Refineries and Chemical Plants*. Volume 1. 2<sup>nd</sup> Edition. Gulf Publishing Company, Houston, Texas.
- Fahim, M.A., Alsahhaf, T.A., and Elkilani, A. 2010. *Fundamentals of Petroleum Refining*. Elsevier, Amsterdam, Netherlands.
- Fu, S.B., Cenegy, L.M., and Neff, C.S. 2001. A Summary of Successful Field Applications of a Kinetic Hydrate Inhibitor. Paper No. SPE-65022-MS. Proceedings. SPE International Symposium on Oilfield Chemistry, Houston, Texas. February 13-16. Society of Petroleum Engineers.
- Gary, J.G., Handwerk, G.E., and Kaiser, M.J. 2007. *Petroleum Refining: Technology and Economics*, 5<sup>th</sup> Edition. CRC Press, Taylor & Francis Group, Boca Raton, Florida.
- Himmelblau, D.M., and Riggs, J.B. 2012. *Basic Principles and Calculations in Chemical Engineering*, 8<sup>th</sup> Edition. Prentice Hall, Pearson Education Inc., Upper Saddle River, New Jersey.
- Holloway, M.D., and Rudd, O. 2013. *Fracking: The Operations and Environmental Consequences of Hydraulic Fracturing*. Scrivener Publishing, Beverly, Massachusetts.
- Hsu, C.S., and Robinson, P.R. (Editors) 2006. *Practical Advances in Petroleum Processing*. Volume 1 and Volume 2. Springer Science, New York.
- Jones, D. 1996. *Principles and Prevention of Corrosion*, 2<sup>nd</sup> Edition. Prentice Hall, Pearson Education Inc., Upper Saddle River, New Jersey.
- Lake, L.W. 2006. *Petroleum Engineering Handbook*. Society of Petroleum Engineers, Richardson, Texas.
- Lee, S. 1991. *Oil Shale Technology*. CRC Press, Taylor & Francis Group, Boca Raton, Florida.
- Lee, S. 1996. *Alternative Fuels*. Taylor & Francis Publishers, Washington, DC (now: CTC Press, Taylor & Francis Group, Boca Raton, Florida).



- Lee, S., Speight, J.G., and Loyalka, S.K. 2007. *Handbook of Alternative Fuel Technologies*. CRC Press, Taylor & Francis Group, Boca Raton, Florida.
- Lynch, T.R. 2008. *Process Chemistry of Lubricant Base Stocks*. CRC Press, Taylor & Francis Group, Boca Raton, Florida.
- Lyons, W.C. (Editor). 1996. *Standard Handbook of Petroleum & Natural Gas Engineering*, Volumes 1 and 2. Gulf Publishing Company, Houston, Texas.
- Mang, T. 2007. Rheology of Lubricants, in *Lubricants and Lubrication*, 2<sup>nd</sup> Edition, Ed. by T. Mang and W. Dresel, 23-33. Wiley-VCH Verlag GmbH & Co. KGaA, Weinheim, Germany.
- Masel, R.I. 2001. *Chemical Kinetics and Catalysis*. Wiley-Interscience, New York (now: John Wiley & Sons Inc., Hoboken, New Jersey).
- McCabe, W.L., Smith, J.C., and Harriot, P. 2005. *Unit Operations of Chemical Engineering*, 7<sup>th</sup> Edition. McGraw-Hill, New York.
- Mireault, R., and Dean L. (Principal Authors). 2008. *Reservoir Engineering for Geologists*. Canadian Society of Petroleum Geologists, Calgary, Alberta, Canada.
- Mokhtab, S., Poe, W.A., and Speight, J.G. 2006. *Handbook of Natural Gas Transmission and Processing*. Elsevier, Amsterdam, Netherlands.
- Mushrush, G.W., and Speight, J.G. 1995. *Petroleum Products: Instability and Incompatibility*. Taylor & Francis, Washington DC (now: Boca Raton, Florida).
- NIST. 2011. CODATA Recommended Values of the Fundamental Physical Constants: 2006. NIST Standard Reference Database 121. 1 Oct. 2008. Physical Measurement Laboratory of NIST. March 2.
- OSHA. 2016. OSHA Technical Manual, Section IV, Chapter 2: Petroleum Refining Processes. [http://www.osha.gov/dts/osta/otm/otm\\_iv/otm\\_iv\\_2.html](http://www.osha.gov/dts/osta/otm/otm_iv/otm_iv_2.html)
- Parkash, S. 2003. *Refining Processes Handbook*. Gulf Professional Publishing, Elsevier, Amsterdam, Netherlands.
- Perry, R.H., and Green, D.W. 1997. *Perry's Chemical Engineers' Handbook*, 7<sup>th</sup> Edition. McGraw-Hill, New York.
- Poveda, C.A., and Lipsett, M.G. 2014. *Surface Mining in Oil Sands: Establishing Sustainable Development Indicators (SDIs)*. WIT Press, Billerica, Massachusetts.
- Rachinsky, M.Z., and Kerimov, V.Y. 2015. *Fluid Dynamics of Oil and Gas Reservoirs*. Scrivener Publishing, Beverly, Massachusetts.
- Reis, J.C. 1996. *Environmental Control in Petroleum Engineering*. Gulf Publishing Company, Houston, Texas.
- Rochelle, G.T. 2009. *Amine Scrubbing for Carbon Dioxide Capture*. *Science*, 325(5948): 1652-1654.
- Sadeghbeigi, R. 2012. *Fluid Catalytic Cracking Handbook*, 3<sup>rd</sup> Edition. Butterworth-Heinemann, Elsevier Science, Oxford, United Kingdom.
- Salmi, T.O., Mikkola, J-P., and Wärnå, J.P. 2011. *Chemical Reaction Engineering and Reactor Technology*. CRC Press, Taylor & Francis Group, Boca Raton, Florida.
- Samuel, G.R. 2010. *Formulas and Calculations for Drilling Operations*. Scrivener Publishing, Beverly, Massachusetts.
- Scouten, C.S. 1990. Oil Shale. In *Fuel Science and Technology Handbook*. Marcel Dekker Inc., New York. Chapters 25 to 31. Pages 795-1053.
- Seader, J.D., and Henley, E.J. 1998. *Separation Process Principles*. John Wiley & Sons Inc., New York (now: Hoboken, New Jersey).
- Sloan, E.D. Jr. 2000. *Hydrate Engineering*. SPE Monograph Series. Society of Petroleum Engineers, Richardson, Texas.
- Sloley, A.W. 2014. Atmospheric Distillation Process – Fundamental Concepts. Paper 20d. Presented at the 2014 Spring Meeting. American Institute of Chemical Engineers. New Orleans, Louisiana. March 30-April 3. [https://www.ch2m.com/sites/default/files/content/person/attachments/Atmospheric%20Distillation%20Process%20%E2%80%93%20Fundamental%20Concepts%20\\_no%20appendexes\\_.pdf](https://www.ch2m.com/sites/default/files/content/person/attachments/Atmospheric%20Distillation%20Process%20%E2%80%93%20Fundamental%20Concepts%20_no%20appendexes_.pdf)
- Smith, J.M., Van Ness, H.C., and Abbott, M.M. 2005. *Introduction to Chemical Engineering Thermodynamics*, 7<sup>th</sup> Edition. McGraw-Hill, New York.
- Speight, J.G. 2003. *Perry's Standard Table and Formulas for Chemical Engineers*. McGraw-Hill, New York.
- Speight, J.G. 2007. *Natural Gas: A Basic Handbook*. Houston: Gulf Publishing Company, Houston, Texas.
- Speight, J.G. 2008. *Synthetic Fuels Handbook: Properties, Processes, and Performance*. McGraw-Hill, New York.
- Speight, J.G. 2009. *Enhanced Recovery Methods for Heavy Oil and Tar Sands*. Gulf Publishing Company, Houston, Texas.
- Speight, J.G. (Editor). 2011. *Biofuels Handbook*. Royal Society of Chemistry, London, United Kingdom.
- Speight, J.G. 2011. *The Refinery of the Future*. Gulf Professional Publishing, Elsevier, Oxford, United Kingdom.
- Speight, J.G. 2011. *An Introduction to Petroleum Technology, Economics, and Politics*. Scrivener Publishing, Beverly, Massachusetts.
- Speight, J.G. 2012b. *Shale Oil Production Processes*. Gulf Professional Publishing, Elsevier, Oxford, United Kingdom.
- Speight, J.G. 2013a. *Shale Gas Production Processes*. Gulf Professional Publishing, Elsevier, Oxford, United Kingdom.
- Speight, J.G. 2012a. *Crude Oil Assay Database*. Knovel, New York. Online version available at: [http://www.knovel.com/web/portal/browse/display?\\_EXT\\_KNOVEL\\_DISPLAY\\_bookid=5485&VerticalID=0](http://www.knovel.com/web/portal/browse/display?_EXT_KNOVEL_DISPLAY_bookid=5485&VerticalID=0)
- Speight, J.G. 2013. *The Chemistry and Technology of Coal*, 3<sup>rd</sup> Edition. CRC Press, Taylor & Francis Group, Boca Raton, Florida.
- Speight, J.G. 2014. *The Chemistry and Technology of Petroleum*, 5<sup>th</sup> Edition. CRC Press, Taylor & Francis Group, Boca Raton, Florida.
- Speight, J.G. 2014. *High Acid Crudes*. Gulf Professional Publishing, Elsevier, Oxford, United Kingdom.
- Speight, J.G. 2014. *Gasification of Unconventional Feedstocks*. Gulf Professional Publishing, Elsevier, Oxford, United Kingdom.
- Speight, J.G. 2014. *Oil and Gas Corrosion Prevention*. Gulf Professional Publishing, Elsevier, Oxford, United Kingdom.
- Speight, J.G., and Exall, D.I. *Refining Used Lubricating Oils*. CRC Press, Taylor and Francis Group, Boca Raton, Florida, 2014.
- Speight, J.G. 2015. *Handbook of Petroleum Product Analysis*, 2<sup>nd</sup> Edition. John Wiley & Sons Inc., Hoboken, New Jersey.
- Speight, J.G. 2015. *Fouling in Refineries*. Gulf Professional Publishing, Elsevier, Oxford, United Kingdom, 2015.
- Speight, J.G. 2015. *Asphalt Materials Science and Technology*. Butterworth-Heinemann, Elsevier, Oxford, United Kingdom.
- Speight, J.G. 2016. *Introduction to Enhanced Recovery Methods for Heavy Oil and Tar Sands*, 2<sup>nd</sup> Edition. Gulf Professional Publishing, Elsevier, Oxford, United Kingdom.
- Speight, J.G. 2016. *Handbook of Hydraulic Fracturing*. John Wiley & Sons Inc., Hoboken, New Jersey.

- Speight, J.G., and Islam, M.R. 2016. *Peak Energy – Myth or Reality*. Scrivener Publishing, Beverly, Massachusetts.
- Speight, J.G. 2017. *Deep Shale Oil and Gas*. Gulf Professional Publishing, Elsevier, Oxford, United Kingdom.
- Speight, J.G. (Editor). 2017. *Lange's Handbook of Chemistry*, 17<sup>th</sup> Edition. McGraw-Hill Education, New York.
- Srivastava, S.P., and Hancsók, J. 2014. *Fuels and Fuel Additives*. John Wiley & Sons Inc., Hoboken, New Jersey.
- Trambouze, P., Van Landeghem, P., and Wauquier, J.P. 1988. *Chemical Reactors – Design/Engineering*. Editions Technip, Paris, France.
- Walsh, M.P., and Lake, L.W. 2003. *A Generalized Approach to Primary Hydrocarbon Recovery*. Elsevier, Amsterdam, Netherlands.
- Wang, X., and Economides, M. 2009. *Advanced Natural Gas Engineering*. Gulf Publishing Company, Houston, Texas.

# ALSO OF INTEREST

**Check out these other related titles from Scrivener Publishing**

## **From the Same Author**

*Ethics in the University*, by James G. Speight, ISBN 9781118872130. Examining the potential for unethical behavior by all academic staff, both professionals and non-professionals, this groundbreaking new study uses documented examples to show where the matter could have been halted before it became an ethics issue and how to navigate the maze of today's sometimes confusing ethical academic arena. *NOW AVAILABLE!*

*Ethics in Engineering*, by James G. Speight and Russell Foote, ISBN 9780470626023. Covers the most thought-provoking ethical questions in engineering. *NOW AVAILABLE!*

*Peak Energy: Myth or Reality?* by James G. Speight and M. R. Islam, ISBN 9781118549421. This groundbreaking study, written by two of the world's foremost authorities in the energy industry, examines our planet's energy future from the perspective of the "peak oil" philosophy. *AVAILABLE IN MAY 2016.*

*Coal-Fired Power Generation Handbook*, by James G. Speight, ISBN 9781118208465. The most complete and up-to-date handbook on power generation from coal, this book covers all of today's new, cleaner methods for creating electricity from coal, the environmental challenges and concerns involved in its production, and developing technologies. *NOW AVAILABLE!*

*Bioremediation of Petroleum and Petroleum Products*, by James Speight and Karuna Arjoon, ISBN 9780470938492. With petroleum-related spills, explosions, and health issues in the headlines almost every day, the issue of remediation of petroleum and petroleum products is taking on increasing importance, for the survival of our environment, our planet, and our future. This book is the first of its kind to explore this difficult issue from an engineering and scientific point of view and offer solutions and reasonable courses of action. *NOW AVAILABLE!*

*An Introduction to Petroleum Technology, Economics, and Politics*, by James Speight, ISBN 9781118012994. The perfect primer for anyone wishing to learn about the petroleum industry, for the layperson or the engineer. *NOW AVAILABLE!*

# **WILEY END USER LICENSE AGREEMENT**

Go to [www.wiley.com/go/eula](http://www.wiley.com/go/eula) to access Wiley's ebook EULA.